

ASEAN+3

Bond Market Guide

The logo of the Asian Development Bank (ADB), consisting of the letters 'ADB' in white serif font inside a dark blue square.

ADB

ASEAN+3

Bond Market Guide

Asian Development Bank

A decorative graphic at the bottom of the page consisting of several overlapping, wavy lines in shades of green and blue, creating a sense of movement and depth.

© 2012 Asian Development Bank

All rights reserved. Published in 2012.
Printed in Philippines.

ISBN 978-92-9092-633-7 (PDF)
Publication Stock No. RPT124540

Cataloging-In-Publication Data

Asian Development Bank.
ASEAN+3 Bond Market Guide
Mandaluyong City, Philippines: Asian Development Bank, 2012.

1. Regionalism 2. Subregional cooperation 3. Economic development 4. Asia I. Asian Development Bank.

The views expressed in this publication are those of the authors and do not necessarily reflect the views and policies of the Asian Development Bank (ADB) or its Board of Governors or the governments they represent.

ADB does not guarantee the accuracy of the data included in this publication and accepts no responsibility for any consequence of their use.

By making any designation of or reference to a particular territory or geographic area, or by using the term “country” in this document, ADB does not intend to make any judgments as to the legal or other status of any territory or area.

ADB encourages printing or copying information exclusively for personal and noncommercial use with proper acknowledgment of ADB. Users are restricted from reselling, redistributing, or creating derivative works for commercial purposes without the express, written consent of ADB.

Note:

In this publication, “\$” refers to US dollars.

Asian Development Bank
6 ADB Avenue, Mandaluyong City
1550 Metro Manila, Philippines
Tel +63 2 632 4444
Fax +63 2 636 2444
www.adb.org

For orders, please contact:
Department of External Relations
Fax +63 2 636 2648
adbpub@adb.org

This report is the outcome of a regional technical assistance project, RETA 6514 Harmonization of Bond Standards in ASEAN+3 under the ASEAN+3 Bond Market Initiative to support the ASEAN+3 Bond Market Forum (ABMF). The project was managed by Seung Jae Lee, Principal Financial Sector Specialist of the Office of Regional Economic Integration. The co-authors of the report are ADB Consultant Prof. Shigehito Inukai, Dr. Taiji Inui, and Mr. Matthias Schmidt, together with ABMF Members and Experts.

Preface

The establishment of the ASEAN+3 Bond Market Forum (ABMF) was endorsed by the ASEAN+3 Finance Ministers at the 13th ASEAN+3 Finance Ministers' Meeting on 2 May 2010 in Tashkent, Uzbekistan, as a common platform to foster standardization of market practices and harmonization of regulations relating to cross-border bond transactions in the region.

Since the first meeting in September 2010 in Tokyo, Japan, ABMF members and experts met quarterly: in December 2010 in Manila, Philippines; February 2011 in Kuala Lumpur, Malaysia; June 2011 in Jeju Island, Republic of Korea; September 2011 in Bali, Indonesia; and December 2011 in Beijing, People's Republic of China. The members and experts invested a lot of effort to produce the first outputs of ABMF as a regional framework to support collaboration between the public and private sectors in the region.

The report, titled ASEAN+3 Bond Market Guide, consists of two volumes; Volume 1: Sub-Forum 1 - Comparative Analysis and Bond Market Guides, and Volume 2: Sub-Forum 2 - Information on Transaction Flows and Settlement. The report aims to dispel misunderstanding and misperception persistently existing against Asian markets. The report is expected to narrow information gaps and establish a common understanding on how markets in the regions operate.

The report was compiled by the Asian Development Bank (ADB) Team comprising Satoru Yamadera (Economist, ADB Office of Regional Economic Integration), Seung Jae Lee (Principal Financial Sector Specialist, ADB Office of Regional Economic Integration), Shinji Kawai (Senior Financial Sector Specialist [Banking], ADB Office of Regional Economic Integration), and with other ADB staff, Shigehito Inukai (ADB consultant), Taiji Inui (ADB consultant), and Matthias Schmidt (ADB consultant). However, the report should not be regarded as outputs of the team, but as a result of the collective work of ABMF members and experts. The international experts kindly shared their market guide information, as well as their expertise with the team to initiate the study. The information enabled the team to start the study from solid ground. The national members and experts provided answers to questionnaires prepared by the team, thoroughly reviewed the draft, and gave valuable comments.

In addition, the team thanks all interviewees who gave useful comments and responses during the market consultations. Therefore, the report should be regarded as a crystallization of regional collaborative efforts and knowledge towards more harmonized and integrated ASEAN+3 bond markets. Without such strong support and cooperation from the ABMF members and experts, as well as from market experts in the region, the report could not have been published.

Especially, leadership provided by Tokyo AIM and Tokyo Stock Exchange Group; CIMB Investment Bank; Korea Securities Depository (KSD); Japan Securities Depository Center (JASDEC); and Indonesian Central Securities Depository (KSEI) as the Chairs and Vice Chairs of SF1 and SF2, who facilitated very active discussions among members and experts. The team also thanks the national members and experts of Japan, Malaysia, Republic of Korea, Indonesia, and People's Republic of China for hosting the ABMF meetings. Smooth organization of the meetings made possible the conduct of intensive discussions at each meeting.

The efforts for harmonization and standardization of bond markets in the region have just begun. Given large differences in economic and market developments in the region, the task is not easy. The work is inevitably gradual and step-by-step. However, this unique regional initiative will create a momentum to push the region towards more harmonized and integrated markets in the future. ABMF continues to function as a regional platform to realize and institutionalize regionalism by helping formulate regional views and opinions into a common policy framework.

Finally, it should be noted that no part of the report represents the official views of any of the institutions, which participated as ABMF members and experts, and the ADB team is held responsible for the contents of the reports.

A. ABMF Members, Experts, and Observers

Economy/Jurisdiction	Membership		Institution
Brunei Darussalam	SF1	National Member	Brunei International Financial Centre (BIFC), Ministry of Finance
Brunei Darussalam	SF2	National Member	Autoriti Monetari Brunei Darussalam (AMBD)
Cambodia	SF1	National Member	National Bank of Cambodia
Cambodia	SF1 and SF2	National Member	Securities and Exchange Commission (SEC) of Cambodia
China, People's Rep. of	SF1 and SF2	National Member	People's Bank of China (PBOC)
China, People's Rep. of	SF1 and SF2	National Member	China Securities Regulatory Commission (CSRC)
China, People's Rep. of	SF1	Observer	National Association of Financial Market Institutional Investors (NAFMII)
China, People's Rep. of	SF1 and SF2	National Expert	China Securities Depository and Clearing Corporation (CSDCC)
China, People's Rep. of	SF1 and SF2	National Expert	China Central Depository and Clearing Corporation Limited (CCDC)
China, People's Rep. of	SF2	National Expert	Shanghai Clearing House (SCH)
China, People's Rep. of	SF2	National Expert	China Foreign Exchange Trade System/National Interbank Funding Center (CFETS)
Hong Kong, China	SF1 and SF2	National Member	Hong Kong Monetary Authority (HKMA)
Indonesia	SF1 and SF2	National Member	Ministry of Finance of Indonesia
Indonesia	SF1 and SF2	National Member	Indonesian Capital Market and Financial Institution Supervisory Agency (BAPEPAM-LK)
Indonesia	SF2	National Member	Indonesian Central Securities Depository (KSEI)
Indonesia	SF1 and SF2	National Member	Indonesia Stock Exchange (IDX)
Japan	SF1	National Member Chair	Tokyo AIM, Tokyo Stock Exchange Group
Japan	SF1	National Member	Japan Securities Dealers Association (JSDA)
Japan	SF1	National Member	Japan Bankers Association (Sumitomo Mitsui Banking Corporation)
Japan	SF1	National Expert	Nomura Securities Co. Ltd.
Japan	SF1	National Expert	Daiwa Securities Capital Markets Co.Ltd.
Japan	SF2	National Member	Japan Securities Depository Center, Inc. (JASDEC)
Japan	SF2	National Expert	Mizuho Corporate Bank, Ltd.
Korea, Rep. of	SF1	National Member	Korea Financial Investment Association (KOFIA)
Korea, Rep. of	SF2	National Member	Korea Securities Depository(KSD)
Korea, Rep. of	SF1 and SF2	National Expert	Korea Capital Market Institute (KCMI)
Korea, Rep. of	SF1	National Expert	Korea Exchange (KRX)
Lao PDR	SF1 and SF2	National Member	Ministry of Finance of Lao PDR
Lao PDR	SF1 and SF2	National Member	Securities and Exchange Commission Office, Bank of the Lao PDR
Malaysia	SF1	National Member Vice-chair	Financial Market Association of Malaysia CIMB Group and CIMB Investment Bank
Myanmar	SF1 and SF2	National Member	Central Bank of Myanmar
Philippines	SF1	National Member	Bureau of Treasury of the Philippines
Philippines	SF1	National Expert	Securities and Exchange Commission of the Philippines
Philippines	SF2	National Member	Philippine Dealing System Holdings Corp (PDS Group)
Philippines	SF2	National Member	Bankers Association of the Philippines (BAP)
Thailand	SF1	National Member	Securities and Exchange Commission
Thailand	SF2	National Member	The Stock Exchange of Thailand (SET)
Thailand	SF1	National Member	Thai Bond Market Association
Viet Nam	SF1	National Member	Vietnam Bond Market Association (VBMA)
Viet Nam	SF2	National Member	Vietnam Securities Depository (VSD)
Viet Nam	SF2	National Member	Hanoi Stock Exchange (HNX)

continued on next page

Table A. continuation

Economy/Jurisdiction	Membership		Institution
–	SF2	International Expert	Citibank
–	SF2	International Expert	Deutsche Bank AG
–	SF2	International Expert	HSBC Securities Services
–	SF2	International Expert	J.P. Morgan
–	SF2	International Expert	State Street Bank and Trust State Street Global Advisors
–	SF2	International Expert	SWIFT
–	SF2	International Expert	The Bank of Tokyo Mitsubishi UFJ Ltd

B. ADB Secretariat and Consultants

Institution	Name	Position
ADB Secretariat	Satoru Yamadera	Economist, Office of Regional Economic Integration (–Sept. 2011) (currently Bank of Japan)
	Seung Jae Lee	Principal Financial Sector Specialist (June 2011–)
	Shinji Kawai	Senior Financial Sector Specialist (Banking) (Sept. 2011–)
ADB Consultant for SF1	Shigehito Inukai	Professor, Faculty of Law, Waseda University
ADB Consultant for SF2	Taiji Inui	Senior Manager, NTT DATA Corporation
ADB Consultant	Matthias Schmidt	Custody Business Specialist

Introduction

Background of the ASEAN+3 Bond Market Forum and the Way Forward

A. Background

ASEAN+3 member countries (Association of Southeast Asian Nations plus People's Republic of China, Japan, and Republic of Korea) have been working to develop bond markets in the region under the Asian Bond Markets Initiative (ABMI) since 2003. Thanks to the regional efforts, as well as individual countries' commitments, the bond markets have grown very rapidly, more than three times since 2003. In 2009 and 2010, after the 2008 financial crisis, the outstanding of emerging East Asia's local currency (LCY) bonds in the region grew 16.2% and 13.6%, respectively, reaching \$5.2 trillion in 2010. This clearly shows that the LCY bond markets can now function as another financial intermediary channel in the region in addition to the banking system. Now, the share of emerging East Asia's LCY bonds in the world's total has reached 8% in 2010, which clearly surpasses those of the United Kingdom (2.5%), Germany (4%), and France (4.8%). Emerging East Asia LCY bonds have become an important asset class, which cannot be overlooked by global investors.

While the LCY bonds are growing very rapidly, intra-regional financial flows are still comparatively small. Financial markets in the region are far less integrated compared to the trade linkages and supply chain network created in the region. Given the differences in levels of economic development, as well as social and cultural values such as language and other practices, it is understandable that each country may want to develop the markets based on their preference. However, it is desirable if market developments are in line with a common understanding of what needs to be harmonized and integrated in the region from the early stage of the market development. If efforts towards harmonization and integration succeed, markets will be able to benefit from a much larger scale of economy and will increase efficiencies. Besides, more integrated markets may be able to mitigate the mismatch of funds: vast savings on the one hand, and enormous needs for investments on the other. Therefore, effective linkage between the two should bring large benefits to the region. The region's investors and issuers should be able to gain substantially from regional cooperation towards more integrated markets. On this front, ASEAN+3 Finance Ministers urged in their 13th joint ministerial statement in 2010

to explore ways to further promote cross-border bond transactions in the region along with the development of local currency-denominated bond markets, given the increasing importance of mobilizing regional savings for regional investments to sustain sound economic growth for ASEAN+3 countries.

To create more integrated markets, we may be able to learn from the European Union (EU). However, unlike Europe, there is no supra-national body in Asia, comparable to the European Commission, to coordinate among member countries and enact rules and regulations uniformly applicable across the region. Unlike in developed markets, the role of the private sector to set standards and common practices is still very limited; thus, national market practice groups are not yet prevailing in many markets in Asia. Therefore, the region needs to start institutionalizing a mechanism to harmonize and integrate markets.

As the first step in that direction, ASEAN+3 Finance Ministers endorsed the establishment of the ASEAN+3 Bond Market Forum (ABMF) in May 2010 as a common platform to foster standardization of market practices and harmonization of regulations relating to cross-border bond transactions in the region. The ABMF is expected not only to lead the region towards more harmonized and integrated markets, but also to act as the nexus between ASEAN+3 and the rest of the world in international standard setting and rule making. ABMF is expected to enhance dialogue between the private sector and ASEAN+3 officials to develop bond markets in the region and promote harmonization, standardization, and integration. Besides, ABMF provides opportunities to exchange knowledge, expertise, and experience between the private and public sectors. ABMF is expected to bridge gaps among regulators in ASEAN+3 for more harmonized regulations; among the private sector players in the region for more standardized market practices; and between the private and public sectors.

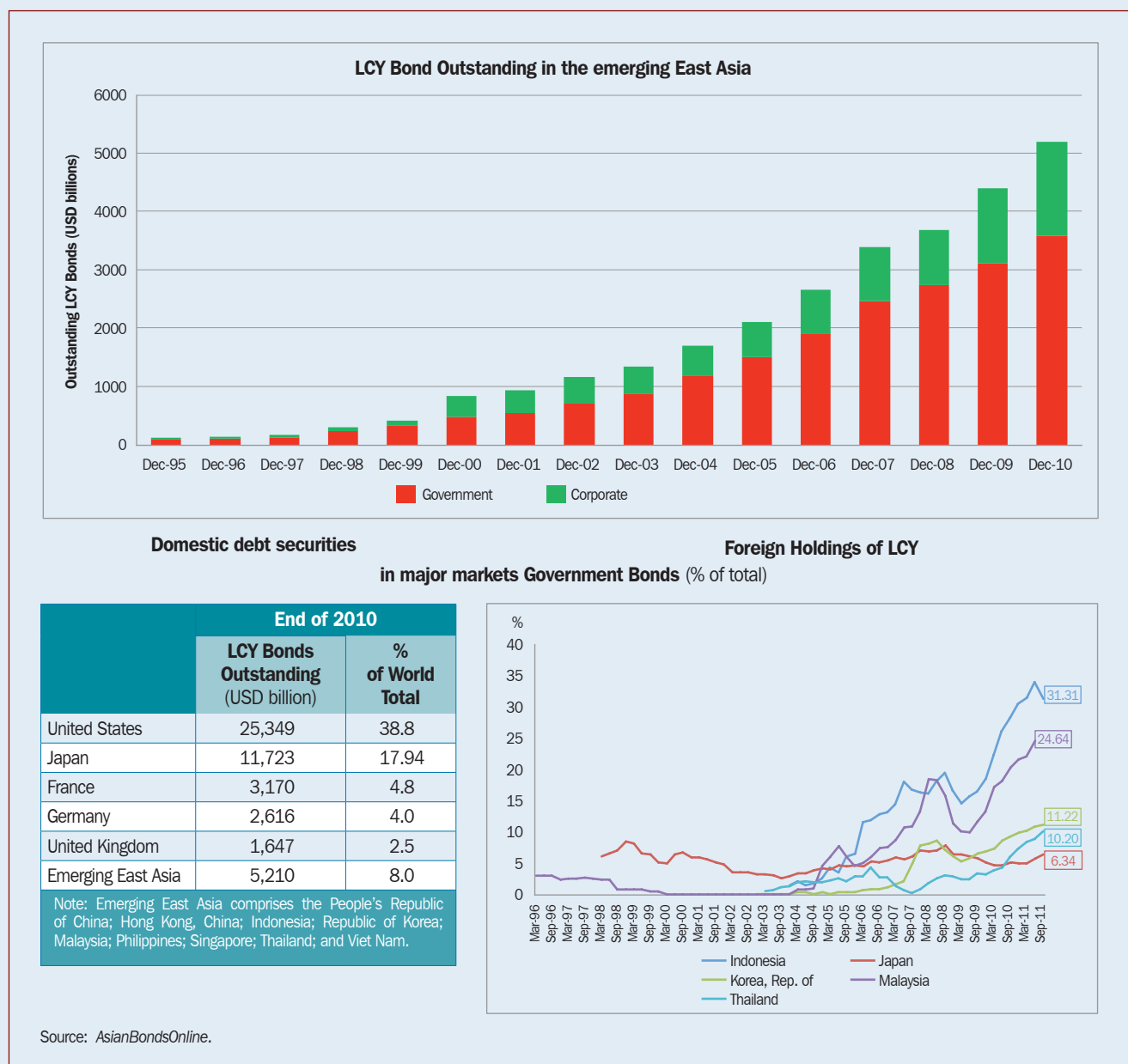
Figure 1. Development of Bond Market in Asia

B. Studies prior to the ASEAN+3 Bond Market Forum

The establishment of ABMF was based on the two studies:¹ ABMI Group of Experts (GoE) Report published in April 2010 and ABMI Harmonization of Bond Standards Report published in September 2010.

The GoE report consists of three parts: Part 1 contains survey results of estimated cross-border transaction costs in ASEAN+3, focusing on custodian fees. Survey result shows that cross-border bond transaction costs in the ASEAN+3 region were

¹ Both studies are downloadable from the ABMF website: <http://asean3abmf.adb.org>

on average three times higher than those of the United States and the EU. Even within ASEAN+3 markets, considerable variation is found across markets. Part 2 discusses the feasibility of two options for RSI, namely Asian International Central Securities Depository and CSD Linkage in Asia, and presents recommendations for possible next steps. The study provides necessary legal and financial conditions for the establishment of a regional RSI. Finally, Part 3 presents the list of major barriers to cross-border bond investment and settlement, and a set of recommendations to address them. The study also finds perception gaps as significant impediments since market participants may not always be aware of the progress made by regulators in reforming or removing some of the impediments. The study recommends the establishment of a coordinating body to facilitate possible reduction of these barriers.

The Harmonization Report discusses how to promote the development of domestic and regional bond markets by: (i) harmonizing standards, including regulations, practices, and infrastructure in secondary government bond markets, including proposing measures to establish a bond market forum to support the process; (ii) harmonizing standards for corporate bonds to facilitate cross-border issuance; (iii) strengthening self-regulatory organizations (SROs) and/or establishing new ones, as appropriate, to facilitate the harmonization of corporate bond standards and regional bond market integration; and (iv) informing institutional investors of updates on bond market situation and initiatives undertaken to achieve an efficient bond market.

Based on the recommendations of the two reports, it was agreed that ABMF should take stock of the findings and recommendations by the GoE. First, ABMF should tackle improving information flows to narrow the information gap by facilitating access to information on regulations and market practices. In addition, harmonization and standardization may start from the settlement barriers identified by the GoE because settlement-related discussion can be initiated by the private sector and, unlike taxation and capital controls, politically sensitive discussion can be avoided. After the initial studies, the region can start harmonizing bond standards where possible, such as harmonization of corporate bond standards through discussions among SROs.

Table 1. List of Major Market Barriers Identified by the Group of Experts Report

Settlement barriers	Messaging standards Securities numbering; Settlement cycle Trade and settlement matching; and Physical certificates
Regulatory barriers	Foreign investor quota Foreign investor registration; Currency exchange controls Cash controls—credit balances; Cash controls—over drafts Taxes; Omnibus accounts Regulatory framework; and Legal framework
GoE = Group of Experts. Source: Asian Bond Markets Initiative (ABMI) Group of Experts Report for Task Force 4 (TF4).	

C. Structure of ASEAN+3 Bond Market Forum

The ABMF aims to: (i) assess existing regulatory frameworks and identify recommendations on how to foster harmonization of regulations and market practices that facilitate cross-border bond transactions in the region; (ii) enhance

dialogue between the private sector and ASEAN+3 officials to develop bond markets in the region and promote harmonization, standardization, and integration; and (iii) provide opportunities to exchange knowledge, expertise, and experience between the private and public sectors in the region.

The ABMF will (i) provide in-depth analysis of bond markets in the region and make intra-regional comparisons to identify national differences, and target market characteristics required for harmonization and standardization; (ii) explore issues to promote harmonization of bond standards to facilitate cross-border issuance and investment; (iii) prepare a strategy and road map for the harmonization of regulations and market practices; and integration of bond markets across the region.

ABMF is a very unique regional initiative. Unlike Europe, there is no supra-national body in Asia comparable to the European Commission to coordinate the member countries and enact rules and regulations uniformly applicable across the region. Unlike developed markets, the role of the private sector to set standards and common practices is limited, thus, national market practice groups are not relevant in Asia. ABMF is expected to bridge such gaps, as well as the gap among the regulators in ASEAN+3 for more harmonized regulations; among private sector players in the region for more standardized market practices; and between the private and public sectors for more integrated markets in the region.

After the establishment of ABMF, national working groups were established in Japan, Republic of Korea, and the Philippines, called ABMF-Japan (ABMF-J), ABMF-Korea (ABMF-K), and ABMF-Philippines (ABMF-PH). The national working groups support information collection; gather opinions and comments in the market; and discuss among market player's and help consolidate opinions. This is a very encouraging evolution because it shows how the region may be able to formalize regional voices into actions. Likewise, the other national members and experts are encouraged to form their national working groups. Though it is still at an early stage, ABMF can lead in the institutionalization of regionalism.

In terms of the governance, activities under ABMF will be closely reported to ASEAN+3 finance ministries and central banks. ABMF shall provide ASEAN+3 officials with viewpoints and recommendations of the regions' bond market experts on issues that will be adopted by Task Force 3 (TF3) of the ABMI. Then, TF3 will decide the agenda to be discussed under ABMF. At this moment, there are two sub-forums. If TF3 wants to expand discussion to other areas, they can create another sub-forum under ABMF. In other words, ABMF will be an umbrella framework to facilitate regional discussion. It will consult with the co-chairs of TF3 from time to time in undertaking any regional activities and will report to TF3 on a regular basis regarding the progress of its activities.

ABMF participants are made up of financial experts from ASEAN+3. The experts are nominated as National Members by their respective governments and central banks. In addition, additional experts are invited as National Experts and International Experts based on the consent of the National Members. Members and experts should be selected from among those actively involved in bond markets in the region as they must have extensive knowledge on and expertise in the relevant issues.

D. The Two Sub-Forums

As a first step, ABMF began discussions with two sub-forums. Sub-Forum 1 (SF1) was established to collate and compare regulations and market practices in the region, while Sub-Forum 2 (SF2) was established to harmonize and standardize transaction procedures and bond-messaging formats with a view to cut the cost of cross-border transactions. This arrangement was based on the GoE report, which recommends improving information flows to foreign investors by facilitating access to information on regulations, and to tackle major barriers from the settlement barriers among private sector experts.

Figure 2. Organizational Structure of Asian Bond Markets Initiative and ASEAN+3 Bond Market Forum

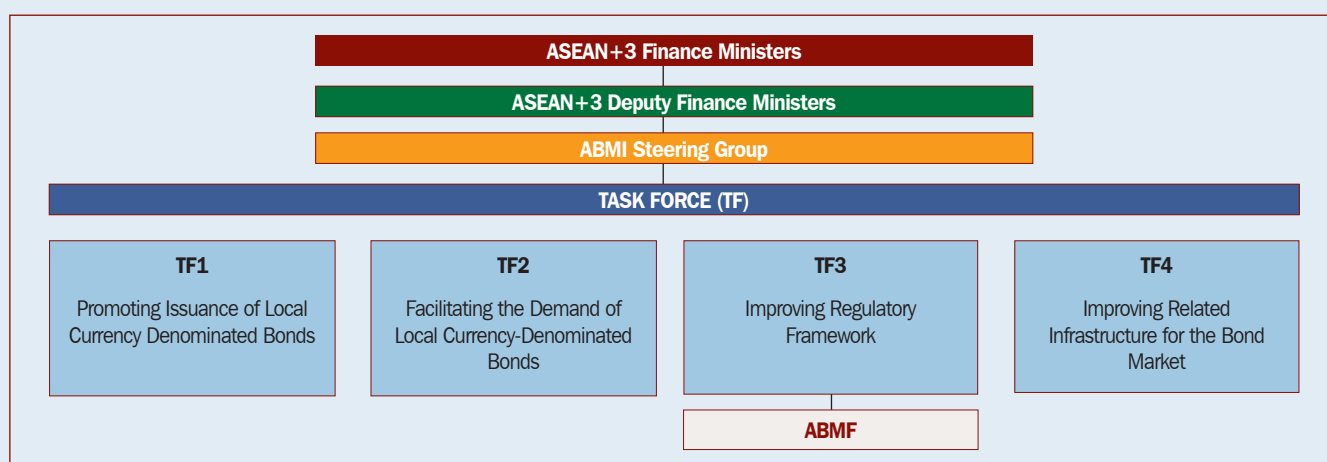
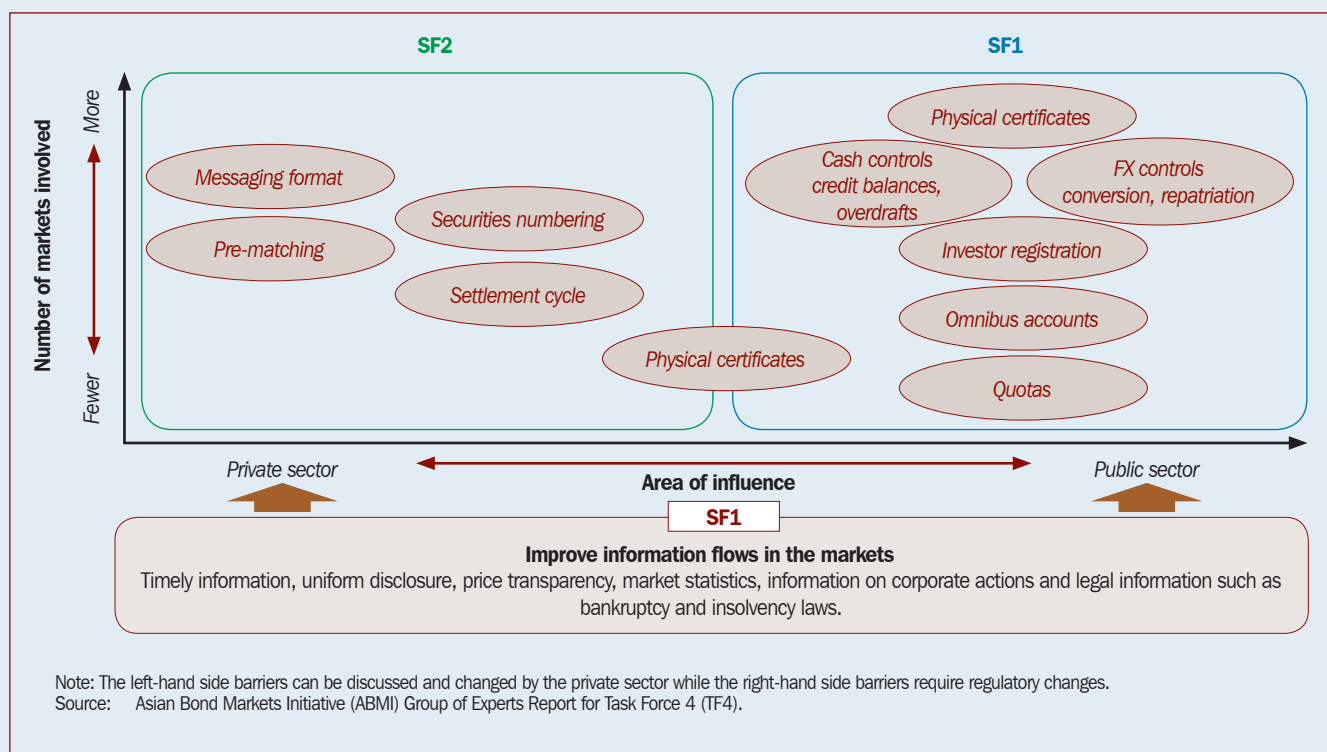

Figure 3. Barriers Identified by Group of Experts and Focus under Sub-Forum 1 and Sub-Forum 2



1. Sub-Forum 1: Collecting Information on Regulations and Market Practices

Sub-Forum 1 (SF1) aims to propose harmonization and standardization of regulations wherever possible. Before harmonizing regulations, it, first, collects all relevant information on regulations and practices as well as market structures, and, second, compares and analyzes the similarities and differences in the region. As the GoE report recommends, it started discussions from improving information flows by facilitating access to information on regulations and market practices. Therefore, information collected through SF1 is as comprehensive and comparable as possible. This information-collection exercise should benefit regional bond markets given the high level of information asymmetry that has led to hesitancy among many investors to participate in Asian bond markets, according to the study by the GoE.

SF1 members consist mainly of industry associations and exchanges in the region because they are often given a status of SRO by the regulators, are in the best position to represent the industry, and can communicate with regulators. In addition, other organizations such as research institutes, which play a role similar to the market associations and enjoy public recognition in the markets, were also qualified as part of the forum. If market associations and relevant industry associations in a country's bond market are either not active or not appropriate for participating in the forum, then, public authorities such as securities commissions and central banks and/or financial institutions can be nominated as national members representing the opinion of the market.

The information collected by SF1 is compiled as market guides, which is available through the AsianBondsOnline, and distributed through members and experts, as well as institutions supporting ABMF.

Table 2. List of Information included in the Sub-Forum 1 Market Guides

Obligation for the Listing of Bond
Main Trading Places (Over-the-Counter or Exchange)
Necessity of the Credit Rating
Methods of Registration of Bonds
Status of Bonds (Bearer or Registered)
Form of the Bonds (Scripless or Physical)
Status of the Scripless Bonds (Complete Dematerialised or Immobilised)
Existence of the Exchangeability of Scripless Bond to Physical Bond
Method of Transfer of Interest in Bonds
Finality of Settlement
Legal Basis and Definition of "Settlement and Clearing"
Existence of the Omnibus Accounts
Existence of the Nominee Concept
Regulators' Policy Related to the Necessity of Disclosure of Ultimate Beneficially Owner
Documentation Language
Definition of the Payment Default
Bankruptcy Procedures
Existence of the Meeting of Bondholders
The Way of Trustee (Bond Representative or Commissioned Persons) System
Definition of Professional and/or Institutional Investors
Public Offering Market (Full Disclosure) Rules and Regulation
Private Placement Rules and Definition of Professional (Institutional) Investor and High Net Worth Individuals.

1. Sub-Forum 2: Enhancing Regional Straight-Through-Processing

Sub-Forum 2 (SF2) aims to enhance regional straight-through-processing (STP) by harmonization of transaction procedures and standardization of messaging formats, hence, transaction costs can be reduced. The GoE report identifies various settlement barriers, such as messaging formats, securities numbering, and trade and settlement matching. ABMF addresses these problems to enhance regional STP.

To achieve the objective, SF2 clarifies all transaction procedures involved in cross-border bond transactions from a buyer to a seller. Ideally, it is desirable to execute a cross-border transaction without any manual processes or transaction-information conversion between the two systems. This ideal situation can materialize only if all transactions are operated through systems using common standards and the same messaging. This is not currently possible because individual countries have their own system and standards, which is inevitable because certain transaction procedures follow national requirements to account for unique circumstances. In addition, some segments of a market may prefer their own ways of handling transactions, which creates differences in transaction procedures, hence, requires additional conversions to international practices.

Market fragmentation is one of challenges the region is facing. High Asian savings should be recycled within the region but, at this moment, investing in neighboring countries is not easy due to various constraints. For example, unlike Europe where they agreed to use English as the common language for financial transactions, difference in languages in the region is one of the constraints. Chinese characters and Thai letters need to be converted into alphabets to execute cross-border transactions. This problem could be mitigated if all transactions were executed under the International Organization for Standardization's (ISO) new standard, ISO20022.² ISO20022 incorporates technology that can process different national letters and characters. In addition, under the flexible framework of ISO20022, the region can develop regional standards, which conform with international standards.

Furthermore, SF2 may be able to help reducing cross-border transaction costs by increasing competition among financial telecommunications networks. The region needs a more efficient and cheaper money- and securities-transfer system for more integrated and harmonized financial markets. By clarifying various cross-border transaction procedures and enhancing STP, the costs involved in cross-border transactions can be reduced. The work under the forum is the first step to achieve the goal.

SF2 members are mainly comprised of national CSDs, local, regional and global custodians. SF2 is envisioned to become a regional market practice group, and the nexus to ISO and other international standard setting forums for settlement.

² International Standard Organization (ISO) is a worldwide federation of national standards bodies. ISO20022 provides the financial industry with a common platform for the development of messages in a standardized XML syntax using (i) a modeling methodology (based on UML) to capture, in a syntax-independent way, financial business areas, business transactions, and associated message flows; and (ii) a set of XML design rules to convert the messages described in UML into XML schemas.

The information collected by SF2 is compiled as market information on transaction flows and settlement infrastructures, which is published through the AsianBondsOnline and distributed through the members and experts, as well as institutions supporting ABMF.

E. Next Step Under the Phase 2

Theoretically, there are two approaches to harmonize regulations and market practices in the region: one is the bottom-up approach and the other is the top-down approach.

The bottom-up approach is to harmonize regulations one by one, step by step, or mutually recognize regulations among member countries. The ASEAN Capital Market Forum (ACMF) has been working to establish the ASEAN and Plus Standards, which aim to establish harmonized standards in the ASEAN. They are also working to agree on mutual recognition on certain areas of securities market regulations. Once they can create harmonized standards and mutually recognize certain rules, these can be extended to the Plus Three countries under the ASEAN+3 framework.

The top-down approach is to create commonly applicable rules based on the region's common values and vision. For example, the Eurobond market is self-regulated by the common rule set by the International Capital Market Association (ICMA), not by regulators, because Eurobond market is an offshore market; hence, it is not under any jurisdictions.

Figure 4. Two-Way Approach for Harmonization

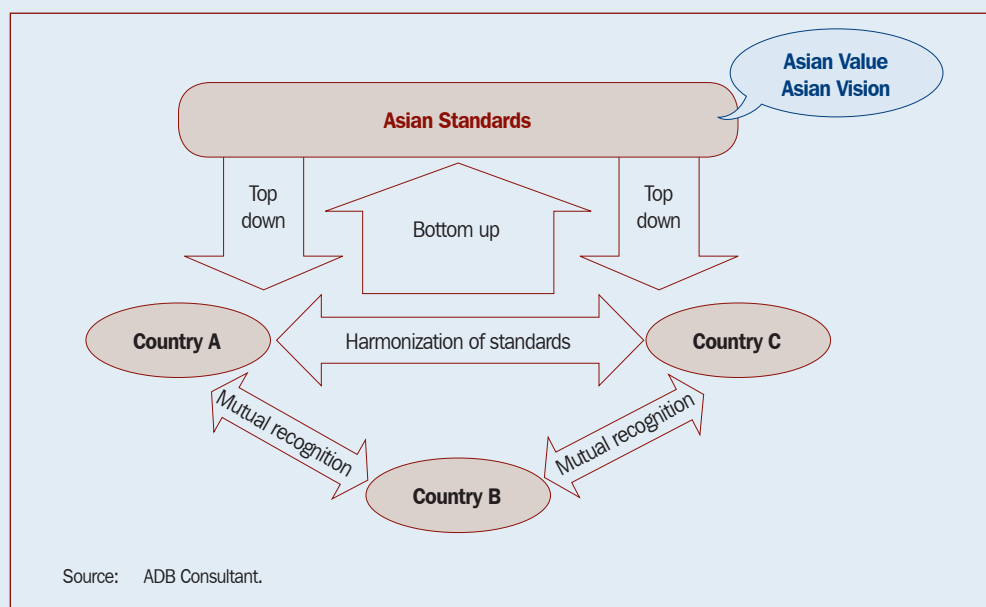

As the next step of SF1, a common bond issuance program will be discussed as an example of the top-down approach. More issuers will need harmonized bond issuance rules to facilitate timely and easier access to LCY funding. However, it would be very time consuming to fully harmonize domestic regulations. Allowing the LCY Eurobond

issue is another approach, but there is legitimate regulatory concern not to allow offshore issue in Asia. To satisfy market needs and regulatory requirements, it is necessary to consider an Asian version of the Eurobond market to meet the region's financial environment. To address the issue, the discussion can start from a narrowly focused area such as private placement by the qualified issuers, qualified investors, and qualified bond traders. By doing so, governments may be able to consider some flexibility. To discuss the common issuance program and make a proposal to governments, establishing a new forum that consists of SROs in the region will be discussed under SF1. The new forum is expected to discuss self-regulations and codes of conduct to create a common issuance scheme.

As the next step for SF2, it will continue to harmonize market practices step by step and message by message, adopting the bottom-up approach. Identifying transaction flows will be extended to issuance, redemption, and interest payment. Also, the scope should be expanded to corporate bonds, which may include some corporate actions. Then, fit-and-gap analysis will be made to clarify areas where harmonization efforts are required. After the analysis, SF2 will propose a road map to standardize and harmonize messaging and market practices.

Structure of the Report

Volume 1: Sub-Forum 1- Comparative Analysis and Bond Market Guides

Overview of Sub-Forum 1

Part 1: ASEAN+3 Bond Markets Comparative Analysis and Implication for the Next Phase of ABMF Sub-Forum 1 (2012–2013)

Part 2: Bond Market Guides in 11 Economies

Volume 2: Sub-Forum 2- Information on Transaction Flows and Settlement

Overview of Sub-Forum 2

Part 1: Bond Markets and Their Infrastructures in ASEAN+3

Part 2: Bond Markets and Their Infrastructures in Each Economy

Part 3: Bond Market Infrastructure Diagrams, Domestic Bond Transaction Flows, and Cross-border Bond Transaction Flows



VOLUME 1

Sub-Forum 1- Comparative Analysis and Bond Market Guides



Overview of Sub-Forum 1

Statement from SF1 Chairs

We wish to express our sincere appreciation to all members and experts of the ASEAN+3 Bond Market Forum Sub-Forum 1 (ABMF SF1) for their contributions towards completing this important research project within the mandated timeframe.

Going forward, we hope to seek continuous support from the members and experts on the second phase of ABMF, which will be critical to our efforts in realizing the vision and objectives of ABMF, i.e., promoting issuance and investment activities within the ASEAN+3 bond markets.

On behalf of our members and experts, we are grateful to the secretariat in the Asian Development Bank (ADB) and its consultants for their efforts that have brought this valuable report into fruition.

February 2012

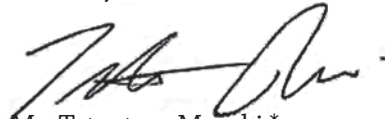

Mr. Tetsutaro Muraki *
Chair of ABMF SF1



Mr. Lee Kok Kwan
Vice-chair of ABMF SF1

* Mr. Tetsutaro Muraki took over as Chair in September 2011, replacing Mr. Yutaka Ito.

Contents

Statement from SF1 Chairs.....	i
Preface.....	1
A. ASEAN+3 Bond Market Forum	1
B. ABMF Sub-Forum 1	1
C. Scope of Markets Covered.....	1
D. Economies Covered under Comparative Analysis and Market Guides	2
E. Configuration of this SF1 Report	2
Executive Summary of SF1	3
A. Overall Assessment—Sound and Robust Market Infrastructure.....	4
B. Summary of Findings	4
1. Over-the-Counter Market	4
2. Regulatory Vacuum in Private Placement	4
3. Bondholder Representative and/or Trustee	4
4. Different Requirements for Identifying Investors and Beneficial Owners	4
5. Public Offering	4
6. Definition of Professional Investors.....	4
7. Common Law Tradition and Civil Law Tradition.....	5
8. Documentation Language.....	5
9. Defining Self-Regulatory Organizations	5
10. Greater Use and Acceptance of Islamic bond (or Sukuk) Structure	5
C. Activities for the Next Phase of ABMF SF1	5
Member List of SF1	7
A. National Members, National Experts, and Observers	7
B. Observing Authorities	8
C. ADB Secretariat and Consultants.....	8

Preface

A. ASEAN+3 Bond Market Forum

The Association of Southeast Asian Nations plus People's Republic of China, Japan, and Republic of Korea (ASEAN+3) established a forum called ASEAN+3 Bond Market Forum (ABMF) in September 2010 as a common platform to foster standardization of market practices and harmonization of regulations relating to cross-border transactions in the region. ABMF reports its activities to the Task Force 3 (TF3) of the Asian Bond Markets Initiative (ABMI) under the institutional framework of ASEAN+3 Finance Ministers Meeting (AFMM+3).

B. ABMF Sub-Forum 1

ABMF consists of two sub-forums. Sub-Forum 1 (SF1) researched, collated, and compared regulations and market practices in the region; Sub-Forum 2 (SF2), on the other hand, looked to harmonize transaction procedures and bond messages with a view of cutting the cost of cross-border deals. This report focuses on the activities of SF1.

Members and experts participated in the ABMF SF1 conducted a survey on regional bond markets and the legal and regulatory infrastructures in ASEAN+3 with support from the Asian Development Bank (ADB) secretariat and consultants. The participants have engaged in fruitful discussions and produced this report, which was submitted to the ASEAN+3 Finance Deputies' Meeting (AFDM+3) through TF3 of the ABMI in December 2011.

C. Scope of Markets Covered

The ASEAN+3 region is composed of 14 economies. These include: (1) Brunei Darussalam, (2) Cambodia, (3) People's Republic of China, (PRC) (4) Hong Kong, China, (5) Indonesia, (6) Japan, (7) Republic of Korea, (8) Lao People's Democratic Republic (Lao PDR), (9) Malaysia, (10) Myanmar, (11) Philippines, (12) Singapore, (13) Thailand, and (14) Viet Nam.

This report covers comparative analyses for bond markets in only ten economies as shown in the following table. On the other hand, 11 economies were covered for the bond market guides that include Lao PDR. Lao PDR, which is in the process of developing a bond market, have voluntarily produced and submitted the Laos Bond Market Guide as a reference for members and interested parties.

D. Economies Covered under Comparative Analysis and Market Guides

	Economy	Economies Subject to Comparative Analysis (Ten Scrippless Securities Markets)	Economies Covered Under Bond Market Guides
1	China, People's Rep. of	✓	✓
2	Hong Kong, China	✓	✓
3	Indonesia	✓	✓
4	Japan	✓	✓
5	Korea, Rep. of	✓	✓
6	Malaysia	✓	✓
7	Philippines	✓	✓
8	Singapore	✓	✓
9	Thailand	✓	✓
10	Viet Nam	✓	✓
11	Lao PDR	–	✓ (voluntary submission for reference) ¹

¹ At the outset, it is understood that the bond markets in Brunei Darussalam, Cambodia, Lao PDR, and Myanmar are planned to be created or in the early stages of development; therefore, as discussed in ABMF Meetings in the past, the ADB secretariat did not ask these developing markets to provide market information. Instead, ABMF members and experts focused more on sharing the information collected from the developing markets to support their actions. This is the reason why the mission was organized to hold workshops in Brunei Darussalam and Lao PDR in May and June 2011. However, this did not entirely prevent the three economies from providing any market information to be included in the market guides. Thus, Lao PDR proactively made a voluntary submission of their Bond Market Guide for reference.

Ten economies included in the research have developed sound and robust bond markets, while four economies are planning and trying to develop their markets.

This report mainly discusses the harmonization and standardization of bond markets of the 10 economies with existing bond markets.

E. Configuration of this SF1 Report

Overview of SF1

Part 1: ASEAN+3 Bond Markets Comparative Analysis and Implication for the Next Phase of ABMF Sub-Forum 1 (2012-2013)

Part 2: Bond Market Guides in 11 Economies

Executive Summary of SF1

A. Overall Assessment—Sound and Robust Market Infrastructure

All of the 10 scripless securities markets covered under this research project have built robust market infrastructures including legal and operational systems to secure transactions in the domestic bond market over the past 10 years. In almost all markets, key legal and operational frameworks are in place. Trades can be executed efficiently in a secure manner; operations and practices in the markets seem comparable to other developed bond markets in the world. Notwithstanding, some still have room for further improvement. Regulators in these markets are encouraged to further eliminate legal and regulatory uncertainty, and to maintain transparency of rules and practices in each domestic market. Markets in the region are distinct in many ways, such as in governing laws and responsible regulators based on their legal tradition and their own market needs. For instance, transfer of ownership of bonds and rules providing the finality of settlement may not be the same; almost all of the markets have established their specific market practices.

Although actual conditions regarding default recognition may be different in the terms and conditions of the bonds and by jurisdiction, default procedures are usually well disclosed in the bonds issuance documentation in many jurisdictions in the region.

These default procedures do not usually deviate from the documentation standards on international bonds issuance. However, in some cases, there are still uncertainties regarding default recognition and procedures.

On the other hand, the status of bankruptcy-related legislation in the region is varied from one jurisdiction to another. Generally, laws on companies, bankruptcy and/or related laws, where applicable, are quoted in the trust deed or similar documents to guide investors in making informed decisions. But in some jurisdictions in the region, bankruptcy-related law and procedures are thought to be in the development stage. It is important to consider the need for greater understanding and further analysis of bankruptcy-related laws and procedures across regional markets in the future.

B. Summary of Findings

1. Over-the-Counter Market

Bonds could be listed on the stock exchanges in many markets, but most of the instruments are traded on the over-the-counter (OTC) market. The OTC market remains the main trading place for the bond markets, but selected exchanges have begun to establish new market segments.

2. Regulatory Vacuum in Private Placement

The regulatory vacuum in private placement in some of the markets can be seen as a place of improvement of the securities law to be put properly as a regulated and exempted private placement market. That sort of clearly stipulated private placement scheme will be an opportunity to propose a common self-regulatory framework for qualified market players in the future.

3. Bondholder Representative and/or Trustee

The concepts of bondholder representative, commissioned bank, and trustee are gaining popularity and are evolving. For example, the new Commercial Code in Republic of Korea, which will come into effect in 2012, is re-defining the role of commissioned banks.

4. Different Requirements for Identifying Investors and Beneficial Owners

Requirements for identifying investors and beneficial owners are different in several countries. For instance, PRC does not allow omnibus accounts under the International Central Securities Depository (ICSD) while the Republic of Korea recently revised its regulation to allow omnibus accounts for ICSDs only. This, on the other hand, is allowed in Japan and in ASEAN. However, there is a growing tendency or desire among regional regulators to increase monitoring.

5. Public Offering

Two general approaches are observed in the markets when it comes to public offering: (1) Full disclosure with specific exemptions and (2) a clearly defined disclosure regime. Markets united in those public offerings meant specified disclosure to all potential investors, whereas private placement or private offerings limited disclosure to only a specific investor group. However, a private offer does not mean no disclosure or no underlying regulations. In some markets there exists a regulatory vacuum in private placement as stated above. In the near future, a specific offering within professional market(s) could cover elements of both concepts of public and private offering. Among the markets covered in the research, Hong Kong and Singapore are closer to international markets while many of the ASEAN+3 markets are still developing.

Generally speaking, creating a common platform for issuance and investment of bonds among ASEAN+3 countries may not be that difficult since the necessary underlying concepts are already in place. This may also negate the discussion on whether to pursue onshore or offshore access to such a market.

6. Definition of Professional Investors

Defining professional investors is critically important in view of the next phase of ABMF discussions, as described in section C. Currently, there are varying definitions

of professional investors where they exist. For instance, Indonesia acknowledges the concept but does not define it by law. In the case of Japan, the concept is clearly defined in recent legislation to create the TOKYO PRO-Bond Market. Malaysia does not have a direct definition, but the Capital Markets and Services Act of 2007 (CMSA) contains relevant provisions on how excluded offerings of bonds could be made to institutional and high net worth investors. Thailand has specific definitions for ‘institutional investors.’

7. Common Law Tradition and Civil Law Tradition

Although market regulations in the region vary in many ways, this does not mean that harmonization is impossible. Markets can be categorized into different groups if regulations are viewed from certain angles. For instance, markets with common law tradition such as Singapore, Malaysia, and Hong Kong share the same trustee concept. Markets with civil law tradition like PRC, Indonesia, Japan, Republic of Korea, Thailand, and Viet Nam, while they may not have the concept of trustee, support the concept of an entity acting for bondholders; names, roles, fiduciary duties, and type of institutions, though, may differ (bondholders representative or commissioned bank, etc.). Generally, if the details are looked into, the differences may not be as significant as they appear.

8. Documentation Language

Documentation language is important to add more details. Some jurisdictions have added other languages for documentation. One such case is in Hong Kong, China where Chinese is now an acceptable documentation language in the Hong Kong market.

9. Defining Self-Regulatory Organizations

Definitions of self-regulatory organizations (SROs) may differ by market but their functions may still be comparable.

10. Greater Use and Acceptance of Islamic bond (or *Sukuk*) Structure

A growing number of jurisdictions now allow or promote the use of Islamic structure in the issuance of bonds in the region. In addition to Malaysia which has the largest Islamic bond market, Indonesia, Thailand, Singapore Hong Kong, and Japan will also launch their own regulatory framework for the issuance of Islamic bonds or Sukuk in their respective bond markets. In general, an issuer’s obligations under a Sukuk issue and the risk exposure of investors are not materially different from a conventional bond issue. If at all such material difference exists, it is usually well disclosed in the offering documents.

C. Activities for the Next Phase of ABMF SF1

Through these market guides and comparative analysis, it is highly expected that the information asymmetry evident in many places will be improved with the intention to attract more attention from investors outside and within the region.

In the future, ASEAN+3 may consider establishing a common framework similar to Eurobond market, possibly modeled on the experiences from the Eurobond market’s

professionals. However, it will be important to understand that the current version of European Union (EU) rules or framework may not be directly applicable to Asia; hence, it may be necessary to establish an Asian version of such marketplace. Thus, the key objectives for ABMF Phase 2 will be to facilitate cross-border or inter-regional initiatives of issuance and investment of bonds. Two standard approaches come to mind: a bottom-up approach as in the ASEAN and a top-down approach driven by the private sector. The preferred approach might focus on private placements or exempted market from full-disclosure requirement for ordinary public offerings across jurisdictions. This might create a professional marketplace populated only by qualified investors. The key outcome would be an organized, well-documented common regional private placement market—this is where the SRO concept would come in as part of discussions on effective governance.

Creating an offshore market remains a consideration as it will attract a set of regulatory concerns. Hence, the emphasis should clearly be on efforts to allow cross-border transactions within the domestic bond markets, with a target to arrive at a common or commonly accepted framework for these transactions.

With qualified issuers and investors currently restricted to access to many domestic bond markets in the region, it will be possible to establish common rules with reasonable efforts. This could possibly lead to a common regional medium-term note (MTN) program within jurisdictions that are committed to open up their markets to qualified issuers and investors in the region. For this proposal to be accepted, it is important to achieve a common understanding among regulatory authorities on the viewpoints expressed above. Meanwhile, activities for the next phase of ABMF SF1, where possible, should take into account the relevant experience from the International Capital Markets Association (ICMA) and SROs from Europe and other regions. In this regard, it will be relevant for members and experts to reach out to investment banks, institutional investors, and lawyers in their respective markets since their input will be important to gauge the actual demand and supply situation in the second phase of ABMF SF1.

Member List of SF1

A. National Members, National Experts, and Observers

Economy/Jurisdiction		Institution
Brunei Darussalam	National Member	Brunei International Financial Centre (BIFC), Ministry of Finance
Cambodia	National Member	National Bank of Cambodia
Cambodia	National Member	Securities and Exchange Commission (SEC) of Cambodia
China, People's Rep. of	National Member	People's Bank of China (PBOC)
China, People's Rep. of	National Member	China Securities Regulatory Commission (CSRC)
China, People's Rep. of	Observer	National Association of Financial Market Institutional Investors (NAFMII)
China, People's Rep. of	National Expert	China Securities Depository and Clearing Corporation (CSDCC)
China, People's Rep. of	National Expert	China Central Depository and Clearing Corporation Limited (CCDC)
Hong Kong, China	National Member	Hong Kong Monetary Authority (HKMA)
Indonesia	National Member	Ministry of Finance of Indonesia
Indonesia	National Member	Indonesian Capital Market and Financial Institution Supervisory Agency (BAPEPAM-LK)
Indonesia	National Member	Indonesia Stock Exchange (IDX)
Japan	National Member Chair	Tokyo AIM, Tokyo Stock Exchange Group
Japan	National Member	Japan Securities Dealers Association (JSDA)
Japan	National Member	Japan Bankers Association (Sumitomo Mitsui Banking Corporation)
Japan	National Expert	Nomura Securities Co. Ltd.
Japan	National Expert	Daiwa Securities Capital Markets Co.Ltd.
Korea, Rep. of	National Member	Korea Financial Investment Association (KOFIA)
Korea, Rep. of	National Expert	Korea Capital Market Institute (KCMI)
Korea, Rep. of	National Expert	Korea Exchange (KRX)
Lao PDR	National Member	Ministry of Finance of Lao PDR
Lao PDR	National Member	Securities and Exchange Commission Office, Bank of the Lao PDR
Malaysia	National Member Vice-chair	Financial Market Association of Malaysia CIMB Group and CIMB Investment Bank
Myanmar	National Member	Central Bank of Myanmar
Philippines	National Member	Bureau of Treasury of the Philippines
Philippines	National Expert	Securities and Exchange Commission of the Philippines
Thailand	National Member	Securities and Exchange Commission
Thailand	National Member	Thai Bond Market Association
Viet Nam	National Member	Vietnam Bond Market Association (VBMA)

B. Observing Authorities

Economy	Institution
Cambodia	Ministry of Economy and Finance
Cambodia	National Bank of Cambodia
Indonesia	Bank Indonesia
Indonesia	Ministry of Finance
Japan	Ministry of Finance
Japan	Bank of Japan
Korea, Rep. of	Bank of Korea
Lao PDR	Ministry of Finance
Malaysia	Bank Negara Malaysia
Malaysia	Securities Commission Malaysia
Philippines	Bangko Sentral ng Pilipinas
Singapore	Monetary Authority of Singapore
Thailand	Bank of Thailand
Viet Nam	Ministry of Finance of Viet Nam
Viet Nam	State Bank of Viet Nam

C. ADB Secretariat and Consultants

Institution	Name	Position
ADB Secretariat	Satoru Yamadera	Economist, Office of Regional Economic Integration (-Sept. 2011) (currently Bank of Japan)
	Seung Jae Lee	Principal Financial Sector Specialist (June 2011-)
	Shinji Kawai	Senior Financial Sector Specialist (Banking) (Sept. 2011-)
ADB Consultant for SF1	Shigehito Inukai	Professor, Faculty of Law, Waseda University
ADB Consultant for SF2	Tajji Inui	Senior Manager, NTT DATA Corporation
ADB Consultant	Matthias Schmidt	Custody Business Specialist

Part 1

Comparative Analysis and Implication for the Next Phase of ABMF Sub-Forum 1 (2012–2013)

Contents

Economies Covered in the Comparative Analysis.....	1
Summary of Findings.....	2
A. Overall Assessment – Sound and Robust Market Infrastructure.....	2
B. Sub-Forum 1: Summary of Findings	10
Implications for the Next Phase of the ASEAN+3 Bond Market Forum Sub-Forum 1 (2012–2013)	21
Details of SF1 Contents of Findings.....	29
I. Legal Tradition in the Domestic Capital Markets	30
II. Governing Law for Domestic Bond Issuance	30
III. Competent Authority (Regulator) and Self-Regulatory Organizations of Domestic Bond Markets	35
IV. Role of the Self-Regulatory Organizations in Domestic Bond Markets	36
V. Definition of Securities (Bonds)	44
VI. Event of Default and Payment Default	48
VII. Existence of the Meeting of Bondholders System.....	51
VIII. The System of Commissioned Company, Bond Representative and Trustee.....	52
IX. Bankruptcy Procedures.....	53
X. Form of Bonds (Settlement Method) and Status (Bearer/Registered)	56
XI. Exchangeability of Scripless Bonds to Physical Bonds.....	57
XII. Transfer of Securities (or Property Rights) and Finality of Settlement of Scripless Bonds.....	58
XIII. Legal Basis and Definition of “Settlement and Clearing”	63
XIV. Registration and Issuing Approval Procedures of Bonds	66
XV. Necessity of Disclosure of Ultimate Beneficial Owner	77
XVI. Foreign Exchange and Currency-Related Restrictions	78
XVII. Omnibus Securities Account and Nominee Concept	79
XVIII. Main Trading Places (Over the Counter or Exchange) and Existence of Exchange trading	80
XIX. Listing of Bonds and Obligation for Market Listing (Domestic Market)	80
XX. Necessity of Credit Rating for the Issuing of Bonds	81
XXI. Documentation Language.....	82
XXII. Concept/Definition of Professional or Institutional investors	83
XXIII. Definition of Public Offering (and Private Placement or Exempt Regime)	86

XXIV. Existence of Professional Investors-Only Market	89
XXV. Market Capitalization – Size of the Local Currency Bond Market (as of March 2011).....	90
XXVI. Size of Foreign Currency Bond Market (as of March 2011)	90
XXVII. Islamic Finance related Issues.....	90

Appendix.....	93
----------------------	-----------

Reference.....	94
-----------------------	-----------

Figures and Table

Figures

Figure 2.1 ASEAN+3 Government Bond Market Infrastructure Diagram	11
Figure 2.2 Regional Standardization of Documentation	22
Figure 2.3 Exempted Market versus Full Disclosure Market	22
Figure 2.4 Comparative Structure of US Domestic and Offshore Markets	23
Figure 2.5 Status Quo of Asean+3 Bond Markets	24
Figure 2.6 Connecting the Professional Market Elements in the Region	24
Figure 2.7 Creation of an Intra-Regional Bond Market.....	25
Figure 2.8 Mutual Recognition Examples (1), (2), (3)	26

Tables

Table 1.1 Economies Covered in the Comparative Analysis.....	1
Table 1.2 Existence of a Clear Definition of Securities (Bonds)	2
Table 1.4 Forms and Status of Bonds across Economies	4
Table 1.5 Exchangeability of Scripless Bonds to Physical Bonds.....	5
Table 1.6 Existence of a Concept of Bondholder Meeting.....	6
Table 1.7 Existence of Concepts of Commissioned Company,	6
Bond Representative and Trustee	6
Table 1.8 Obligation to Acquire Credit Rating upon Bond Issuance	6
Table 1.9 Main Market Authorities across covered Economies	7
Table 1.10 Self-Regulatory Organizations across ASEAN+3 Bond Markets.....	7
Table 1.12 Foreign Exchange and Currency-Related Restrictions.....	8
Table 2.1 Over-the-Counter Market versus Exchange Market	10
Table 2.2 Existence of Exempt Regimes	12
Table 2.3 Status of Concepts of Commissioned Company, Bondholder Representative and Trustee	12
Table 2.4 Legal Tradition	13
Table 2.5 Requirements for Identifying Investors and Beneficial Owners.....	14
Table 2.6 Existence of Omnibus Accounts or Nominee Concept	14
Table 2.7 Existence of Exempt Regimes	15
Table 2.8 Existence of the Concept of Professional Investor	16
Table 2.9 Existence of Professional Investor-Only Market	17
Table 2.10 Definitions of Self-Regulatory Organizations	17
Table 2.11 Existence of the Islamic Finance Market	20

Details of SF1 Contents of Findings: Tables

Table 1.	Legal Tradition in the Domestic Capital Markets.....	30
Table 2.	Governing Law for Domestic Bond Issuance	30
Table 3.	Competent Authority (Regulator) and Self-Regulatory Organizations of Domestic Bond Markets	35
Table 4.	Role of Self-Regulatory Organizations in Domestic Bond Markets.....	36
Table 5.	Definition of Securities (Bonds).....	44
Table 6.	Event of Default and Payment Default	48
Table 7.	Existence of Bondholders Meeting System	51
Table 8.	The System of Commissioned Company, Bond Representative and Trustee.....	52
Table 9.	Bankruptcy Procedures	53
Table 10.	Form of Bonds (Settlement Method) and Status (Bearer/Registered)	56
Table 11.	Exchangeability of Scripless Bonds to Physical Bonds.....	57
Table 12.	Transfer of Securities (or Property Rights) and Finality of Settlement of Scripless Bonds.....	58
Table 13.	Legal Basis and Definition of “Settlement and Clearing”	63
Table 14.	Registration and Issuing Approval Procedures of Bonds	66
Table 15.	Necessity of Disclosure of Ultimate Beneficial Owner.....	77
Table 16.	Foreign Exchange and Currency-Related Restrictions.....	78
Table 17.	Omnibus Securities Account and Nominee Concept	79
Table 18.	Main Trading Places (Over the Counter or Exchange) and Existence of Exchange Trading.....	80
Table 19.	Listing of Bonds and Obligation for Market Listing (Domestic Market).....	80
Table 20.	Necessity of Credit Rating for the Issuing of Bonds	81
Table 21.	Documentation Language	82
Table 22.	Concept and Definition of Professional or Institutional investors	83
Table 23.	Definition of Public Offering (and Private Placement or Exempt Regime)	86
Table 24.	Existence of Professional Investors-Only Market	89
Table 25.	Market Capitalization – Size of Local Currency Bond Market (as of March 2011) (\$ billion)	90
Table 26.	Size of Foreign Currency Bond Market (as of March 2011) (\$ billion).....	90
Table 27.	Islamic Finance-Related Issues.....	90

Economies Covered in the Comparative Analysis

This report mainly discusses the harmonization and standardization of bond markets of 10 economies with existing bond markets in the Association of Southeast Asian Nations, People's Republic of China, Japan and Republic of Korea (ASEAN+3).

Table 1.1 Economies Covered in the Comparative Analysis

	Economy	Economies Subject to Comparative Analysis (Ten Scripless Securities Markets)	Economies Covered Under Bond Market Guides
1	China, People's Rep. of	✓	✓
2	Hong Kong, China	✓	✓
3	Indonesia	✓	✓
4	Japan	✓	✓
5	Korea, Rep. of	✓	✓
6	Malaysia	✓	✓
7	Philippines	✓	✓
8	Singapore	✓	✓
9	Thailand	✓	✓
10	Viet Nam	✓	✓
11	Lao PDR	–	✓ (voluntary submission for reference) ^a

^a At the outset, it is understood that the bond markets of Brunei Darussalam, Cambodia, Lao People's Democratic Republic (PDR), and Myanmar are in the planning stage for creation or in the early stages of development; therefore, as discussed in the ASEAN+3 Bond Market Forum (ABMF) in the past, the ADB secretariat did not ask these developing markets to provide market information. Instead, ABMF members and experts focused on sharing the information collected from these developing markets to support their initiatives to establish or develop their respective bond markets. This is the reason the ABMF secretariat held workshops in Brunei Darussalam and Lao PDR in May and June 2011. However, this did not entirely prevent the two economies from providing any market information to be included in the market guides. Lao PDR proactively and voluntarily submitted their bond market guide as reference.

Source: ADB Consultants, based on research materials and market visit information.

Summary of Findings

A. Overall Assessment – Sound and Robust Market Infrastructure

All of the 10 securities markets covered under this research project have built robust market infrastructures, including legal and operational systems to secure transactions in the domestic bond market over the past 10 years.

In almost all markets, key legal and regulatory frameworks and related systems are in place. The following tables detail some of the features of these key bond-market infrastructures.

For instance, a clear definition of securities (bonds) is considered to be a fundamental base and condition for the sound development of the bond market. Most of the jurisdictions have a specific definition of securities, or are striving to further improve or clarify the definition of securities.

Table 1.2 Existence of a Clear Definition of Securities (Bonds)

Jurisdiction	Existence of a Clear Definition of Securities (Bonds)
People's Republic of China	<p>Securities concepts may differ by industry or by competent authority in China. The <i>Corporation Law</i> and <i>Enterprise Law</i> co-exist and, hence, either may set rules for issuance of securities, depending on the industry, issuer, and type of security.</p> <p>The official definition of securities is provided in the <i>Securities Law</i> of PRC, which was revised in 2005.</p> <p>The present law shall be applied to the issuance of and transactions in stocks, corporate bonds, as well as any other securities lawfully recognized by the State Council within the territory of the PRC. However, some bonds do not fall under the <i>Securities Law</i>. In case where there is no such provision in the present law, the provisions of the <i>Corporation Law</i> and other relevant laws and administrative regulations shall be applied.</p>
Hong Kong, China	<p>For bonds to be listed on the Hong Kong Stock Exchange or cleared through the Central Moneymarkets Unit (CMU), they must satisfy the criteria as set out in, among others, the Listing Rules and CMU Service Reference Manual (which is accessible to CMU members only), respectively. Also, a definition of securities is laid down in the <i>Securities and Futures Ordinance</i> (SFO) of the Securities and Futures Commission (SFC).</p>
Indonesia	<p>The definition of securities is not confined to a single law. Original relevant definitions found in the commercial code left by the Dutch, and remaining in force are the following: Promissory note (PN), cheque, and bill of exchange.</p> <p>There is no mention of corporate bonds and debt instruments in the <i>Company Law</i>; however, they are often described or covered in the Articles of Association of companies.</p>

continued on next page

Table 1.2 continuation

Jurisdiction	Existence of a Clear Definition of Securities (Bonds)
	The clearest definition of securities can be found in the <i>Capital Market Law No. 8 (1995)</i> . Pursuant to the <i>Capital Market Law</i> , securities are classified as PNs, commercial paper (CP), shares, bonds, evidences of indebtedness, participation units of collective investment contracts, futures contracts related to securities, and all derivatives of securities. Today, the distinction of debt instruments can be divided into the capital market and the money market: (1) the capital market covers bonds, (2) the money market covers PN, medium-term notes (MTN), CP, Certificate of Central Bank (SBI, Sertifikat Bank Indonesia); most instruments have been introduced by foreign bank participants in recent years. MTN and CP are synonymous for all intents and purposes; legal treatises exist but there are no statutory definitions of these instruments.
Japan	The <i>Companies Act</i> defines corporate bonds. A uniform legal framework for all types of securities exists. Distinctions between dematerialization or immobilization and physical securities are clear. Legal ownership structure of dematerialized or immobilized securities is clearly stipulated.
Republic of Korea	The revised <i>Commercial Act</i> (to take effect in 2012) provides a basis for corporate bonds diversity. This should resolve the discrepancy in the definition of securities between the <i>Commercial Act</i> and the <i>Financial Investment Services and Capital Markets Act</i> (FSCMA).
Malaysia	Under section 2(1) of the <i>Capital Markets and Services Act 2007</i> , securities are defined as: (a) debentures, stocks or bonds issued or proposed to be issued by any government; (b) shares in or debentures of, a body corporate or an unincorporated body; or (c) unit trusts or prescribed investments, and includes any right, option or interest in respect thereof, but does not include futures contracts. Debentures are also stipulated in article 125 of the <i>Companies Act 1965</i> .
Philippines	Under section 3 of the <i>Securities Regulation Code</i> (SRC), securities are shares; participation or interests in a corporation or in a commercial enterprise or profit-making venture and evidenced by a certificate; contract; or instrument, whether written or electronic in character. The Philippine Dealing and Exchange (PDEX) Rules for the Fixed Income Securities Market, as amended (PDEX Rules), define securities as fixed-income securities, including government securities.
Singapore	Securities are defined in the <i>Securities and Futures Act</i> (SFA) in sections 2(1), 196A, 214, and 239.
Thailand	Section 4 of the <i>Securities and Exchange Act B.E. 2535</i> stipulates the definition of securities.
Viet Nam	Pursuant to article 3 of the amended and supplemented <i>Securities Law No. 62/2010/QH12</i> and article 6 of <i>Securities Law No. 70/2006/QH11</i> , securities mean evidence from an issuing organization certifying the lawful rights and interest of an owner with respect to assets or capital portion. Securities may take the form of certificates, book entries or electronic data, and shall comprise the following types: 1) shares, bonds and investment fund certificates; 2) share purchase rights (rights issue), warrants, call options, put options, future contracts, groups of securities and securities indices; 3) investment capital contribution contracts; and 4) other types of securities stipulated by the Ministry of Finance.

Source: ADB Consultants, based on research materials and market visit information.

Trades can be executed efficiently in a secure manner; operations and practices in the markets are comparable to other developed bond markets. All of the 10 securities markets now have a scripless securities system. Notwithstanding, some still have room for further improvement in maximizing the benefits available from such systems.

Table 1.3 Existence of Scripless Securities System

Jurisdiction	Existence of Scripless Securities System
People's Republic of China	Yes
Hong Kong, China	Yes
Indonesia	Yes
Japan	Yes
Republic of Korea	Yes
Malaysia	Yes

continued on next page

Table 1.3 continuation

Jurisdiction	Existence of Scripless Securities System
Philippines	Yes
Singapore	Yes
Thailand	Yes
Viet Nam	Yes

Source: ADB Consultants, based on research materials and market visit information.

The introduction of scripless securities led to the issuance, keeping and transfer of bonds on a book-entry basis in these markets. This reduces operational risk significantly. In this context, it is noteworthy that the People's Republic of China (China) and Japan have implemented a 'registered notes only' policy. In addition, from the viewpoint of exchangeability of scripless bonds to physical bonds, it is observed that scripless bonds can no longer be exchanged to physical bonds in China and Japan. It seems that these two countries are pursuing the same policy direction.

Table 1.4 Forms and Status of Bonds across Economies

Jurisdiction	Form of the Bonds (Settlement Method)	Status (Bearer/Registered)
People's Republic of China	<ul style="list-style-type: none"> Book-entry 	Registered. (Bonds are generally getting scripless in a central register and registered in an account holder's or bondholder's name; some older bearer bonds may still exist. As for China Central Depository and Clearing (CCDC)-settled bonds in the China Inter-bank Bond Market, CDCC centralized the management of the bearer bond library in 1998, and 2001 saw the end of bearer bonds in this market.)
Hong Kong, China	<ul style="list-style-type: none"> Book-entry form (dematerialized) for Exchange Fund paper, and Global note form for corporate bonds 	Bearer/Registered
Indonesia	<ul style="list-style-type: none"> Book entry (from 2000) Physical certificate still exist (issued prior to 2000) 	Bearer/Registered
Japan	<ul style="list-style-type: none"> Book-entry (Completely dematerialized, except for a few non-central securities depository [CSD] settled private placed notes) 	Registered
Republic of Korea	<ul style="list-style-type: none"> Book-entry <p>Dematerialized securities: Securities which are not issued in paper form and where ownership is held and is transferable by book entry in a ledger maintained by a CSD or account management institution.</p> <p>Immobilized securities: Physical securities and non-certificated securities held and transferred by book entry in a ledger maintained by a CSD or account management institution.</p>	Bearer/Registered
Malaysia	<ul style="list-style-type: none"> Listed bonds: Book entry at Bursa Malaysia Depository Unlisted debt securities: Book entry at Bank Negara Malaysia (BNM) 	Basically, registered. Cagamas papers are unsecured bearer bonds issued by Cagamas, the national mortgage corporation established in 1986 to promote the secondary mortgage market in Malaysia.
Philippines	<ul style="list-style-type: none"> Government Securities: Book entry in the Registry of Scripless Securities (RoSS) or in the Philippine Depository and Trust Corporation (PDTC) Scripless Corporate Bonds: Book entry in PDTC Physical Corporate Bonds: Endorsement and actual delivery of physical certificates with duly notarized Deed of Assignment 	Bearer/Registered. Dematerialization/immobilization versus physical securities: both equities and debt securities are legally recognized in physical and dematerialized forms. In the organized market for debt securities, however, debt securities must be in dematerialized form and cannot be listed if the same are still in physical form, even if immobilized.

continued on next page

Table 1.4 continuation

Jurisdiction	Form of the Bonds (Settlement Method)	Status (Bearer/Registered)
Singapore	<ul style="list-style-type: none"> Book entry for government bonds The Central Depository Pte. (CDP) holds universal certificates for physical bonds 	Bearer/Registered. A foreign issuer is normally required to appoint a paying agent in Singapore while debt securities are quoted on the Exchange and upon the issue of debt securities in definitive form. The Exchange may accept other arrangements to enable definitive certificate holders of the bearer debt securities in Singapore to be paid promptly.
Thailand	<ul style="list-style-type: none"> Book entry Promissory notes (PNs) and commercial papers are physical, bearer instruments <p>In accordance with sections 225 to 228 of the <i>Securities and Exchange Act (SEA)</i>, immobilization in the Thailand Securities Depository (TSD) system has been arranged through the transfer of securities by book entry.</p> <p>The transfer of securities by book entry shall be deemed to be the delivery of securities, which constitutes the legal basis for the validity of securities transfer under section 199 and section 51 of the SEA. Moreover, securities transferred into the name of the TSD shall be presumed to be securities held by the TSD on behalf of its members or for any customers of its members.</p> <p>However, there is no explicit legislation for the dematerialization of securities.</p>	Bearer/Registered. PNs are physical, bearer instruments issued by banks and other financial institutions.
Viet Nam	<ul style="list-style-type: none"> Book entry Municipal bonds are physical, bearer instruments. Corporate bonds and state-owned enterprises (SOE) bonds can be held in bearer or registered form. Listed corporate bonds have to be deposited at the Vietnam Securities Depository to be eligible for trading on the Exchanges. 	Bearer/Registered

Source: ADB Consultants, based on research materials and market visit information.

Table 1.5 Exchangeability of Scripless Bonds to Physical Bonds

Jurisdiction	Exchangeability of Scripless Bonds to Physical Bonds
People's Republic of China	No
Hong Kong, China	Yes
Indonesia	Yes
Japan	No
Republic of Korea	Yes
Malaysia	Yes
Philippines	Yes
Singapore	Yes
Thailand	Yes
Viet Nam	Yes

Source: ADB Consultants, based on research materials and market visit information.

A bondholder meeting concept is one of the typical indicators of the maturity of a bond market. Ten out of Eleven jurisdictions already feature the bondholder-meeting concept as a basic infrastructure of their respective bond markets.

Table 1.6 Existence of a Concept of Bondholder Meeting

Jurisdiction	Existence of a Concept of Bondholder Meeting
People's Republic of China	Yes
Hong Kong, China	Yes
Indonesia	Yes
Japan	Yes
Republic of Korea	Yes
Malaysia	Yes
Philippines	Yes
Singapore	Yes
Thailand	Yes
Viet Nam	Meeting concept may be existent, but has not been established as a system.

Source: ADB Consultants, based on research materials and market visit information.

In addition, the existence of concepts of commissioned company, bond representative and trustee is important for investor protection in the bond markets. Most of the jurisdictions have such concepts in place, even though they may vary in name and individual features.

Table 1.7 Existence of Concepts of Commissioned Company, Bond Representative and Trustee

Jurisdiction	Existence of Commissioned Company/Bond Representative/Trustee Concept
People's Republic of China	Yes
Hong Kong, China	Yes
Indonesia	Yes
Japan	Yes
Republic of Korea	Yes
Malaysia	Yes
Philippines	Yes
Singapore	Yes
Thailand	Yes
Viet Nam	-

Source: ADB Consultants, based on research materials and market visit information.

At the same time, a credit rating system also plays an important role in the bond market. Particularly, it is considered that developing markets generally require a compulsory credit rating system for investor protection. Many of the developing markets in the region have such system.

Table 1.8 Obligation to Acquire Credit Rating upon Bond Issuance

Jurisdiction	Obligation to Acquire Credit Rating upon Bond Issuance
People's Republic of China	Yes.
Hong Kong, China	No.
Indonesia	Yes.
Japan	No. But, TOKYO PRO-BOND Market Listing requires a credit rating.
Republic of Korea	Yes.
Malaysia	Yes.

continued on next page

Table 1.8 continuation

Jurisdiction	Obligation to Acquire Credit Rating upon Bond Issuance
Philippines	Yes.
Singapore	No. But, as a foreign debt-securities listing requirement of the Singapore Exchange (SGX), the issue of debt securities must have a credit rating of investment grade and above.
Thailand	Yes.
Viet Nam	No.

Source: ADB Consultants, based on research materials and market visit information.

Regulators in these markets are encouraged to further eliminate legal and regulatory uncertainties, and to maintain transparency of rules and practices in each domestic market.

Table 1.9 Main Market Authorities across covered Economies

Jurisdiction	Main Market Authority
People's Republic of China	<ul style="list-style-type: none"> Inter-bank Bond Market (Over the Counter): People's Bank of China (PBOC) Exchange Market (Shanghai Stock Exchange and Shenzhen Stock Exchange): China Securities Regulatory Commission (CSRC) Foreign Currency Policy: PBOC, State Administration of Foreign Exchange
Hong Kong, China	Hong Kong Monetary Authority
Indonesia	Capital Market and Non-Bank Financial Service Supervisory Agency
Japan	Financial Services Agency
Republic of Korea	Financial Services Commission Financial Supervisory Service
Malaysia	Securities Commission Malaysia
Philippines	Securities and Exchange Commission
Singapore	Monetary Authority of Singapore
Thailand	Ministry of Finance Securities and Exchange Commission
Viet Nam	State Securities Commission (SSC) (Since March 2004, the SSC is under the jurisdiction of the Ministry of Finance of Viet Nam)

Source: ADB Consultants, based on research materials and market visit information.

Aiding the functioning of the bond markets, the role of self-regulatory organizations (SROs) in each domestic market is critically important. In the region, many of the jurisdictions have established SROs.

Table 1.10 Self-Regulatory Organizations across ASEAN+3 Bond Markets

Jurisdiction	Name of SRO	Membership	Sets Rules	Enforcement
People's Republic of China	NAFMII	Yes	Yes	Yes
Hong Kong, China	N/A	N/A	N/A	N/A
Indonesia	IDX KPEI KSEI	Yes Yes Yes	Yes Yes Yes	Yes Yes Yes
Japan	JSDA TSE TOKYO AIM	Yes Yes Yes	Yes Yes Yes	Yes Yes Yes
Republic of Korea	KOFIA KRX	Yes Yes	Yes Yes	Yes Yes

continued on next page

Table 1.10 continuation

Jurisdiction	Name of SRO	Membership	Sets Rules	Enforcement
Malaysia	Bursa Malaysia	Yes	Yes	Yes
	ACI Malaysia (quasi)	Yes	Yes	Yes
Philippines	PDS Group (PDEX)	Yes	Yes	Yes
Singapore	SGX	Yes	Yes	Yes
Thailand	ThaiBMA	Yes	Yes	Yes
	Exchanges	Yes	Yes	Yes
Viet Nam	VBMA	Yes	Yes	–

ACI = Persatuan Pasaran Kewangan Malaysia; IDX = Indonesia Stock Exchange; JSDA = Japan Securities Dealers Association; KOFA = Korea Financial Investment Association; KPEI = Indonesia Clearing and Guarantee Corporation; KRX = Korea Exchange; KSEI = Indonesian Central Securities Depository, Kustodian Sentral Efek Indonesia; NAFMII = National Association of Financial Market Institutional Investors; PDEX = Philippine Dealing and Exchange; SGX = Singapore Exchange; SRO = self-regulatory organization; ThaiBMA = Thailand Bond Market Association; TSE = Tokyo Stock Exchange; VBMA = Vietnam Bond Market Association
Source: ADB Consultants, based on research materials and market visit information

Bond markets in the region are distinct in many ways, such as in governing laws and responsible regulators based on their legal tradition and their own market needs, including documentation languages.

Table 1.11 Documentation Languages

Jurisdiction	Main Language	Alternative Language
People's Republic of China	Chinese	
Hong Kong, China	English	Chinese
Indonesia	Bahasa Indonesia	English
Japan	Japanese*	English for TOKYO-PRO BOND Market Listing
Republic of Korea	Korean (Hangul)	English for Qualified Institutional Buyer Market
Malaysia	English	
Philippines	English	
Singapore	English	
Thailand	Thai	English
Viet Nam	Vietnamese	

* Japan is in the course of introducing a partial English based documentation for disclosure from April 2012; Although the information for securities should be submitted in Japanese, most part of the disclosure information for issuer (including already disclosed reference information) can be submitted in English, except for a certain information. (Non-resident issuers' burden will be reduced)
Source: ADB Consultants, based on research materials and market visit information.

Foreign institutional investors are already able to access all ASEAN+3 active markets for bond investments in local currency, with the exception of the People's Republic of China. Having said so, the renminbi bond market in Hong Kong has been growing. Investors can access one or many ASEAN+3 markets, and buy corporate or government bonds, if they prefer, in local currency.

Table 1.12 Foreign Exchange and Currency-Related Restrictions

Jurisdiction	Foreign Exchange Rate Floating	Restrictions on Foreign Remittance (1. Own currency) (2. Investment principal) (3. Coupons or dividends)	Currencies eligible for CLS Settlement
People's Republic of China	Government-controlled floating, rate referring to currency basket	1. Restricted	–
		2. Restricted for a certain period of time after investment	
		3. Restricted for a certain period of time after investment	
Hong Kong, China	Link to US dollar (Currency Board System)	1. No restriction	Yes
		2. No restriction	
		3. No restriction	

continued on next page

Table 1.12 continuation

Jurisdiction	Foreign Exchange Rate Floating	Restrictions on Foreign Remittance (1. Own currency) (2. Investment principal) (3. Coupons or dividends)	Currencies eligible for CLS Settlement
Indonesia	Floating	1. Restricted. (Rupiah foreign exchange trades must be done by Indonesian domestic banks; rupiah remittance between foreign banks is prohibited)	–
		2. No reporting required for repatriation of benefits.	
		3. Reporting required	
		(*) Real-demand principle applies to inbound foreign exchange or buying Indonesian rupiah only.	
Japan	Floating	1. No restriction	Yes
		2. No restriction. (ex post facto report required)	
		3. No restriction. (ex post facto report required)	
Republic of Korea	Floating	1. Restricted	Yes
		2. No restriction	
		3. No restriction	
Malaysia	Managed float against a basket of currencies, following the de-pegging of the ringgit	1. Restricted (All remittances out of the country must be made in foreign currency). Real-demand principle applies to inbound FX only.	–
		2. No restriction for non-resident investors to repatriate in foreign currency	
		3. No restriction for non-resident investors to repatriate in foreign currency	
Philippines	Floating	1. Restricted. Registration with the Bangko Sentral ng Pilipinas (BSP) for issuance of Bangko Sentral Registration Document (BSRD) on per transaction basis is required to qualify for automatic conversion of peso sale or interest into foreign exchange for outward repatriation.	–
		2. Registration with BSP for issuance of BSRD on per transaction basis is required to qualify for automatic conversion of peso sale or interest into foreign exchange for outward repatriation.	
		3. Interest automatically qualifies for outward repatriation if principal investment has BSRD.	
Singapore	Floating against basket of currencies	1. No restrictions (investor can hold Singapore dollar in Tokyo, for example)	Yes
		2. No restriction	
		3. No restriction	
Thailand	Managed Floating	1. Restricted	–
		2. Reporting is required.	
		3. Reporting is required.	
Viet Nam	Controlled Floating	1. Restricted	–
		2. Restricted for certain period of time after investment	
		3. No restriction	
		(Viet Nam issue is based on availability of foreign currency)	

Source: ADB Consultants, based on research materials and market visit information.

To illustrate such distinction, the transfer of ownership of bonds may not be the same as in the rules governing the finality of settlement; almost all of the markets have established their specific market practices. For details, please refer to “SF1: Contents of Findings, XII. Transfer of Securities (or Property rights) and Finality of Settlement of Scripless Bonds.”

Although actual condition regarding default recognition may be different by the terms and conditions of the bonds and by jurisdiction, default procedures are usually well disclosed in the bonds issuance documentation in many jurisdictions in the region. In many jurisdictions and bonds issuance documentation, these default procedures do not usually deviate from the documentation standards of international bond issues. In some cases, however, there are still uncertainties regarding default recognition and procedures. On the other hand, the status of development of bankruptcy-related legislation in the region differs between jurisdictions.

Generally, the companies act and/or bankruptcy law and/or related laws, where applicable, will be quoted in the trust deed or similar documents to guide investors in making informed decisions. But in some jurisdictions in the region, bankruptcy-related law and procedures are still in the development stage. A greater understanding and further analysis of bankruptcy-related law and procedures across regional markets is important for future consideration.

For details, please refer to “SF1: Contents of Findings, VI. Event of Default/Payment Default” and “SF1: Contents of Findings, IX. Bankruptcy Procedures”

B. Sub-Forum 1: Summary of Findings

1. Over-the-Counter Market and Exchange Market

Bonds can be listed on the stock exchanges in many markets, but most of the instruments are traded on the over-the-counter (OTC) market. The OTC market remains the main trading place for bond markets, but selected exchanges in Republic of Korea and China have begun to establish significant market segments. For instance, transactions in China’s Inter-bank Bond Market involve the trade system of the China Foreign Exchange Trade System (CFETS) and money-brokers, while exchange-market trading is done through the Shanghai Stock Exchange (SSE) and Shenzhen Stock Exchange (SZSE). In addition, since July 2011, Singapore government securities (SGS) can be traded on the Singapore Exchange (SGX), with particular focus for retail investors. On the other hand, Republic of Korea will launch the Qualified Institutional Buyer (QIB) market in May 2012 for professional investors, using the OTC trading platform of the Republic of Korea Financial Investment Association (KOFIA); the market will provide for exemption from the full-disclosure regime in Republic of Korea.

Table 2.1 Over-the-Counter Market versus Exchange Market

Jurisdiction	OTC Market as a Main Trading Place	Exchange-Market Trading
China	Yes. Inter-bank Bond Market, not directly available to foreign investors. Domestic institutions are permitted to trade in OTC market.	Yes (SSE and SZSE).
Hong Kong, China	Yes	Yes (HKEx). But only accounts for a relatively small portion of all the trading in bonds.
Indonesia	Yes	Possible but not observed.
Japan	Yes	No.
Republic of Korea	Yes	Yes (KRX). Government Bonds.
Malaysia	Yes (Only for unlisted debt securities)	No.
Philippines	Yes (Regulated OTC)	No.
Singapore	Yes	Yes. (Government bonds, mainly for retail investors, since July 2011)
Thailand	Yes. BEX provides electronic platform for OTC fixed-income trading named Fixed Income and Related Securities Trading System (FIRST)	No.
Viet Nam	Yes. But not yet regulated.	No.

BEX = Bond Electronic Exchange; SZSE = Shenzhen Stock Exchange; HKEx = Hong Kong Exchanges and Clearing; KRX = Korea Exchange; OTC = over the counter; SSE = Shanghai Stock Exchange
Source: ADB Consultants, based on research materials and market visit information.

The following diagram provides further illustration on the trading to settlement infrastructure across the observed economies.

Figure 2.1 ASEAN + 3 Government Bond Market Infrastructure Diagram

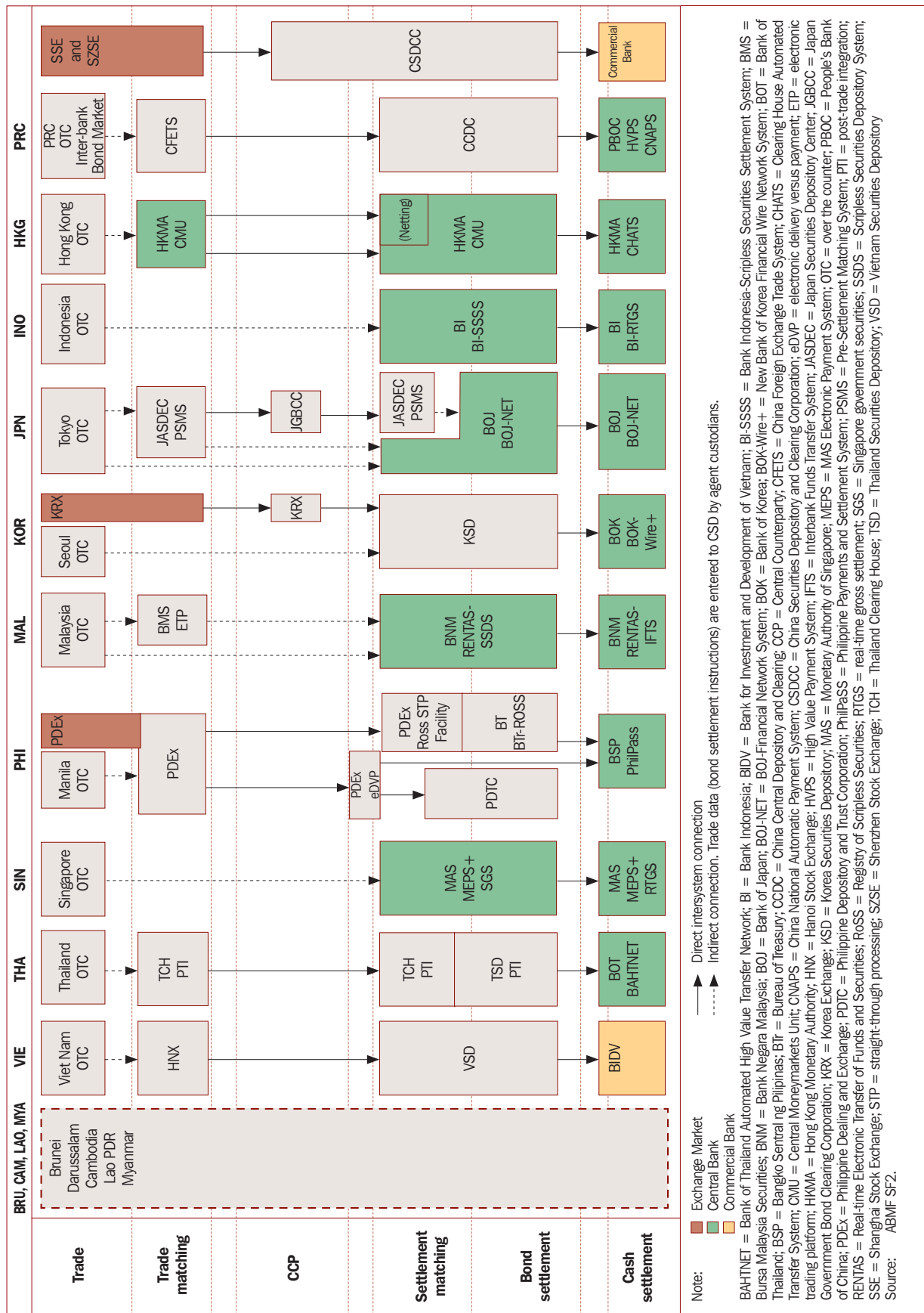

2. Regulatory Vacuum in Private Placement

The regulatory vacuum in private placement in some of the domestic markets can be seen as a place of future improvement of the securities laws to be put properly as a regulated and an exempted private placement market to be taken up in tandem with their development stages.

That sort of clearly stipulated private placement scheme will be an opportunity to propose a regional self-regulatory framework for qualified market participants in the future.

Table 2.2 Existence of Exempt Regimes

Jurisdiction	Existence of Exempt Regimes Exempt securities/Exempt transactions (Private Placement)
People's Republic of China	-
Hong Kong, China	Yes.
Indonesia	No. Private placement (to less than 100) is not regulated in Indonesia.
Japan	Yes.
Republic of Korea	The Qualified Institutional Buyer system (and professional only market) will be launched in May 2012 under the revised Financial Services Commission Regulation on Issuance, Public Disclosure, etc. of Securities.
Malaysia	Yes.
Philippines	Yes.
Singapore	Yes.
Thailand	Yes.
Viet Nam	No. Private placement (to less than 100) or sale to professional investors is clearly stipulated in the amended Securities Law. However, private placement is not regulated as an exempted scheme.

Source: ADB Consultants, based on research materials and market visit information.

3. Bondholder Representative and/or Trustee

The concepts of bondholder representative, commissioned bank, and trustee are gaining popularity and are evolving. For example, the new *Commercial Code* in Republic of Korea, which will come into effect in 2012, is re-defining the role of commissioned banks.

Table 2.3 Status of Concepts of Commissioned Company, Bondholder Representative and Trustee

Jurisdiction	Name of the system	Status of Concepts of Commissioned Company, Bondholder Representative and Trustee
People's Republic of China	Commissioned company	<ul style="list-style-type: none"> Enterprise bonds have this concept; whether it works is untested.
Hong Kong, China	Trustee	<ul style="list-style-type: none"> The appointment of a trustee is done under provisions of the Trust Indenture. The appointment of a trustee is not mandatory. No recent issues or programs featured the concept of trustee.
Indonesia	<i>wali amanat</i> (Trustee)	<ul style="list-style-type: none"> Bapepam-LK has guidelines for registration and the duties as trustee. Trustees must make a contract, <i>perwaliamanatan</i>, with the corporate issuer in accordance with the conditions set out by Bapepam-LK.
Japan	Commissioned person or Commissioned company	<ul style="list-style-type: none"> Stipulated in <i>Companies Act</i>. It shall not be applied in case bond minimum unit is JPY100 million or more.

continued on next page

Table 2.3 continuation

Jurisdiction	Name of the system	Status of Concepts of Commissioned Company, Bondholder Representative and Trustee
Republic of Korea	Commissioned company (Revised <i>Commercial Law</i> which will take effect in 2012)/(Old <i>Commercial Act</i>)	<ul style="list-style-type: none"> Stipulated in the revised <i>Commercial Act</i>. The appointment of a commissioned company is not mandatory. The appointment of a commissioned company is done under provisions of the Trust Indenture.
Malaysia	Trustee	<ul style="list-style-type: none"> Trust deed and trustee is required; based on <i>Trustee Corporation Act</i>. Trustees should be approved by the Securities Commission (SC) and listed on the SC website. AAA issuers may not need a trustee, but such issues need to be approved by SC, and default definitions need to be included in bond issue documentation.
Philippines	Trustee - for Public offering. Facility Agent (FA) - for Private placement	<ul style="list-style-type: none"> Public offering of bond issues typically has a trustee. Corporate bond issuers must appoint a trustee. Private placements require an FA, which functions as a trustee and fiscal agent; in the absence of specific regulations, issue documentation would indicate that the FA works on behalf of investors.
Singapore	Trustee	<ul style="list-style-type: none"> An issuer must appoint a suitable trustee to represent the holders of its debt securities listed on the Exchange. However, a trustee is not required for a debt issue that is offered only to sophisticated or institutional investors and is traded in a minimum board lot size of SGD200,000 or its equivalent in foreign currencies following listing. (Refer to article 308 "Part IV Trustee and Trust Deed" of Chapter 3 (Debt Securities) of the Singapore Exchange Main Board Listing Rules for detailed information on the suitability of the trustee and the provisions to be included in the trust deed.)
Thailand	Bondholder Representative or Trustee	<ul style="list-style-type: none"> No trustee concept for bonds; but bondholder representative (BR). BR has fiduciary duty, plus any duty and liability set out in the terms and conditions; both appointment of BR and actual terms and conditions need to be registered with the Securities and Exchange Commission. Indenture agreements in bond issues can specify a trustee or BR. The trustee oversees bondholder rights, including the filing of claims and demand payments from the issuer or guarantors. Bondholders can sue and claim for damages from the trustee in case the trustee acts in bad faith or causes damages to bondholders.
Viet Nam		<ul style="list-style-type: none"> In Viet Nam, there is no official concept of the meetings of bondholders yet.

Source ADB Consultants, based on research materials and market visit information.

4. Common Law and Civil Law Traditions

Although market regulations in the region vary in many ways, this does not mean that harmonization is impossible. Markets can be categorized into different groups if regulations are viewed from certain angles. For instance, markets with common law tradition, such as Singapore, Malaysia and Hong Kong share the same trustee concept. Markets with civil law tradition like China, Indonesia, Japan, Republic of Korea, Thailand, and Viet Nam, while they may not have the concept of trustee, support the concept of an entity acting for bondholders; names, roles, fiduciary duties and type of institutions, though, may differ (i.e., bondholders representative or commissioned bank, etc.). Generally, if the details are examined, the differences may not be as significant.

Table 2.4 Legal Tradition

Jurisdiction	Original Legal Tradition	Influences
People's Republic of China	Civil law or civil law system	English law, United States (US) law, Japanese law
Hong Kong, China	UK law, Common law	
Indonesia	Islamic law, Dutch law, Civil law or civil law system	US law
Japan	Civil law or civil law system	English law, US law, European Union law
Republic of Korea	Civil law or civil law system	English law, US law, Japanese law
Malaysia	English law, Common law, Islamic law	
Philippines	Spanish law	US law

continued on next page

Table 2.3 continuation

Jurisdiction	Original Legal Tradition	Influences
Singapore	English law, Common law	(Australian law)
Thailand	Civil law or civil law system	English law, US law, Islamic law
Viet Nam	Civil law or civil law system	French law

Source: ADB Consultants, based on research materials and market visit information.

5. Different Requirements for Identifying Investors and Beneficial Owners

Requirements for identifying investors and beneficial owners are different in several countries or jurisdictions. For instance, China does not allow omnibus accounts, even for International Central Securities Depositories (ICSD), while the Republic of Korea recently revised its regulation to allow omnibus accounts for ICSDs only. This, on the other hand, is allowed in Japan and in ASEAN markets. However, there is a growing tendency or desire among regional regulators to increase monitoring.

Table 2.5 Requirements for Identifying Investors and Beneficial Owners

Jurisdiction	Regulators' Policy related to the Necessity of Disclosure of Ultimate Beneficial Owner	Direct or indirect Account Holding System
People's Republic of China	Yes. Beneficial owner to be disclosed.	
Hong Kong, China	No policy	Both
Indonesia	No requirement by law. Typically grouped by tax rate or domicile.	
Japan	No policy	Direct. (Account holders have the rights directly against issuers)
Republic of Korea	No policy	Direct
Malaysia	No policy	
Philippines	No policy	Registered holders have legal rights against the issuer.
Singapore	No policy	Both
Thailand	No policy	Indirect
Viet Nam	No policy	Indirect

Source: ADB Consultants, based on research materials and market visit information.

Table 2.6 Existence of Omnibus Accounts or Nominee Concept

Jurisdiction	Existence of Omnibus Securities Account	Existence of Nominee Concept
People's Republic of China	No. Securities must be kept in the name of the beneficial owner.	No.
Hong Kong, China	Yes.	Yes.
Indonesia	Yes.	Yes.
Japan	Yes.	Yes.
Republic of Korea	Yes. But, the foreign exchange regulation in Republic of Korea does not allow omnibus accounts for payments for foreign investors. To avoid this, foreign investors who use International Central Securities Depositories can use their status as Qualified Foreign Investor and are, thus, allowed to make use of omnibus accounts. (See details "Contents of Findings, XVII. Omnibus Securities Account/Nominee Concept")	Yes. But it cannot be applied to Foreign Investment in Bonds.
Malaysia	Yes.	Yes.
Philippines	Yes.	Yes.

continued on next page

Table 2.6 continuation

Jurisdiction	Existence of Omnibus Securities Account	Existence of Nominee Concept
Singapore	Yes.	Yes.
Thailand	Yes.	Yes.
Viet Nam	Yes.	No.

Source: ADB Consultants, based on research materials and market visit information.

6. Public Offering and Private Placement

Two general approaches are observed in the markets when it comes to public offering:

- (1) Full disclosure with specific exemptions and
- (2) A clearly defined disclosure regime.

Markets are united in referring to public offerings as specified disclosure to all potential investors, whereas private placement or private offerings mean limited disclosure to only a specific investor group. However, a private offer does not mean no disclosure or no underlying regulations. In some markets, there exists a regulatory vacuum in private placement as mentioned previously. In the near future, a specific offering within professional market(s) could cover elements of both concepts of public and private offering.

Among the markets covered in the research, Hong Kong and Singapore are closer to international markets in terms of development; other ASEAN+3 markets are still developing.

Generally speaking, creating a common platform for issuance and investment of bonds among ASEAN+3 countries may not be that difficult since the necessary underlying concepts are already in place. This may also negate the discussion on whether to pursue onshore or offshore access to such a market.

Table 2.7 Existence of Exempt Regimes

Jurisdiction	Existence of Exempt Regimes (Exempt Securities or Exempt Transactions in Private Placement)
People's Republic of China (PRC)	"Self-regulatory Rules for Inter-bank Bond Market Non-financial Enterprise Debt Instrument on Private Placement" provides for the process involved in private-placement instruments including issuance, registration, trading, and information disclosure, among others. Exempt regime is not applied in the PRC.
Hong Kong, China	Yes.
Indonesia	No. Private placement (to less than 100) is not regulated in Indonesia.
Japan	Yes.
Republic of Korea	Yes. The Qualified Institutional Buyer (QIB) system (and Professional only market) will be launched in May 2012 under the revised Financial Services Commission Regulation on Issuance, Public Disclosure, etc. of Securities. Korea Financial Investment Association regulation on management of the QIB system will be enacted before May 2012.
Malaysia	Yes.
Philippines	Yes.
Singapore	Yes.
Thailand	Yes.
Viet Nam	No. Private placement (to less than 100) or sale to professional investors is stipulated in the amended Securities Law clearly. But private placement is not regulated as an exempted scheme.

Source: ADB Consultants, based on research materials and market visit information.

7. Definition of Professional Investors

Defining professional investors is critically important to the next phase of ASEAN+3 Bond Market Forum (ABMF) discussions, as described in section C. Currently, there are varying definitions of professional investors where they exist. For instance, Indonesia acknowledges the concept but does not define it by law. In the case of Japan, the concept is clearly defined in recent legislation to create the TOKYO PRO-Bond Market. Malaysia does not have a direct definition, but the *Capital Markets and Services Act of 2007* (CMSA) contains relevant provisions on how excluded offerings of bonds could be made to institutional and high net worth investors. Thailand has specific definitions for institutional investors.

Table 2.8 Existence of the Concept of Professional Investor

Jurisdiction	Existence of a clear Definition of Professional Investor Concept
People's Republic of China	<ul style="list-style-type: none"> No concept or definition of 'professional' (investor) is evident in Chinese law. The People's Bank of China is mulling over the concept of Qualified Institutional Buyer (QIB).
Hong Kong, China	<ul style="list-style-type: none"> Professional investor is defined in section 1 of Part 1 of Schedule 1 to the <i>Securities and Futures Ordinance</i>, etc.
Indonesia	<ul style="list-style-type: none"> Indonesia does not have specific definitions on this type of professional investors. Bapepam-LK is working on a definition of Professional Investor. Private placement (to less than 100) is not regulated in Indonesia.
Japan	<ul style="list-style-type: none"> The <i>Financial Instruments and Exchange Act</i> stipulates a definition for Specified (Professional) Investor and Qualified Institutional Investor.
Republic of Korea	<ul style="list-style-type: none"> The <i>Financial Investment Services and Capital Markets Act</i> classifies a Professional Investor. But the Republic of Korea so far does not have an exempt regime for Professional Investors. The Republic of Korea will launch the QIB market, which is an exempt regime for Professional Investors in May 2012.
Malaysia	<ul style="list-style-type: none"> Sophisticated Investor is not explicitly defined in the <i>Capital Market and Services Act 2007</i> (CMSA). However, the CMSA exempts sophisticated or professional investors from prospectus requirements.
Philippines	<ul style="list-style-type: none"> <i>Securities Regulation Code</i> (SRC), SRC Rules, Over-the-Counter Rules and Qualified Buyer Rules clearly define Qualified Buyer, Qualified Individual Buyer and Qualified Institutional Buyer. SRC specifies sale to Qualified Buyers as transaction exempt from registration.
Singapore	<ul style="list-style-type: none"> Under <i>Securities and Futures Act</i>, Accredited Investor and Institutional Investor are defined. Exemptions to prospectus requirements include exemptions for offers that are made only to institutional investors and accredited investors, etc.
Thailand	<ul style="list-style-type: none"> "Notification of Securities and Exchange Commission (SEC)" defines Institutional Investors and High Net Worth Investors. Private Placement of corporate bond offers to institutional investors will be exempted from obligation to file disclosure documents to SEC.
Viet Nam	<ul style="list-style-type: none"> The <i>Securities Law</i> defines Professional Securities Investor. The Amended Securities Law defines Non-public offering of securities (Private placement) (to less than 100, etc.).

Source: ADB Consultants, based on research materials and market visit information.

Table 2.9 Existence of Professional Investor-Only Market

Jurisdiction	Existence/Status Quo of the Professional Investors Only Market
People's Republic of China	Does not exist. But the Inter-bank Bond Market consists of institutional participants only. The People's Bank of China is considering the Qualified Institutional Buyer (QIB) concept.
Hong Kong, China	The Hong Kong Exchanges and Clearing Limited has performed market consultation on some proposed changes to the requirements for the listing of debt issues to professional investors only in December 2010 and the Rule amendments were effected in November 2011.
Indonesia	Does not exist.
Japan	Exists. TOKYO PRO-BOND market with listing on the TOKYO AIM.
Korea	The QIB market and trading system will be launched within 2012.
Malaysia	The Securities Commission and Bank Negara Malaysia introduced 'Exempt Regime.'
Philippines	Exemptions are granted for particular securities and transactions.
Singapore	Exists. There is a market for professionals which are exempted from prospectus requirements.
Thailand	Private Placement is exempt from full filing requirement.
Viet Nam	Does not exist.

Source: ADB Consultants, based on research materials and market visit information.

8. Documentation Language

With regards to documentation language, there is a need to study this area in greater detail. Some jurisdictions have added other languages for documentation. One such case is in Hong Kong, China where Chinese is now an acceptable documentation language.

9. Defining Self-Regulatory Organizations

The definitions of SROs may differ by market but their functions are comparable.

Table 2.10 Definitions of Self-Regulatory Organizations

Jurisdiction	Name	Main Functions
People's Republic of China	Inter-bank Bond Market (National Association of Financial Market Institutional Investors [NAFMII]) In 2007, NAFMII was officially established.	<p>NAFMII is mainly responsible for the self-regulatory management of the over-the-counter (OTC) market. The establishment of NAFMII fills in the void of a self-regulatory organization (SRO) in the OTC market, forming a market management mode that comprises both government supervision and market self-regulatory management.</p> <ul style="list-style-type: none"> • Promoting investor protection mechanism. NAFMII is promoting the investor protection mechanism in the non-financial enterprise debt capital market and formulated self-regulatory normative documents such as the "Rules for Meetings of Non-financial Enterprise Debt Holders in the Inter-bank Bond Market." <ol style="list-style-type: none"> 1. Guiding and regulating market with the "Self-Governing Rules and Standardization of Management system of the Market." 2. Further deregulation for issuance of bonds and notes in the inter-bank market.
Hong Kong, China	--	No SROs in Hong Kong bond market.
Indonesia	<ol style="list-style-type: none"> 1. The Indonesia Stock Exchange (IDX) 2. The Indonesian Central Counterparty 3. The Indonesian Central Securities Depository <p>---</p> <p>Each regulates its own areas of operations, subject to Bapepam-LK approval.</p>	<p>As one of the three SROs of the capital market licensed by Bapepam-LK, IDX:</p> <ol style="list-style-type: none"> (1) facilitates and regulates the Exchange. Specifically, it discusses, prepares, acquires approval from Bapepam-LK, issues, and changes Listing Regulations, Trading Regulations and Membership Regulations; (2) develops a mechanism for organizing and monitoring the Exchange; (3) implements Good Corporate Governance practice based on IDX's Corporate Governance Principles; and (4) develops infrastructure and technologies projects with other SROs. <p>To produce professional human resources that can encourage capital market growth, together with other SROs, IDX formed the Association of Indonesian Capital Market Education (P3MI). In 2010, P3MI, in cooperation with University of Indonesia (UI), founded Indonesia Capital Market Institute (TICMI). TICMI is focusing on giving education and training skills to candidates aspiring to become underwriters, investment managers and broker/dealers.</p>

continued on next page

Table 2.10 continuation

Jurisdiction	Name	Main Functions
Japan	Japan Securities Dealers Association (JSDA), Tokyo Stock Exchange Group (TSE), TOKYO AIM	<p>JSDA is the full-fledged SRO for the securities industry in Japan. It issues a variety of rules and market practices/guidelines for bond market participants.</p> <p>Rules: When JSDA members violate these rules, they are subject to disciplinary action by JSDA. JSDA takes into account market conditions and the practical reality of transactions in establishing, revising and abolishing rules for the purpose of achieving fair and smooth transactions in the Japanese market, thereby contributing to the protection of investors. During the rule-making procedure, a draft of rules is prepared first through deliberations mainly by JSDA members. The draft is then subjected to public comment and other processes, and finally approved by JSDA.</p> <p>Guidelines: Guidelines are practical rules that JSDA requests participants in the bond market to comply with (thus recognized as “best practice”). As they are merely practices, those who do not comply are not penalized. However, as voluntary compliance with these guidelines by the overall market contributes to smooth and efficient transactions, most market participants observe the guidelines. Consequently, JSDA collects and considers the opinions of market participants when setting new guidelines or revising/abolishing old ones.</p> <p>Standard Procedures, etc.: Besides the above, JSDA issues from time to time notices to members in advance regarding standard procedures, etc.</p> <p>TSE's role as a self-regulatory organization: It examines companies to assess their suitability as listed companies. It requires these companies to comply with disclosure requirements so that investors are able to make informed decisions, and it provides a market place for those companies' securities to be traded. Pursuant to the Financial Instruments and Exchange Act (FIEA), TSE has self-regulatory functions to maintain a transparent, equitable and reliable market. The TSE has two units in relation to its self-regulatory function: (1) the Listing Regulation Unit deals with issues related to listing and (2) the Compliance Unit deals with issues related to trading participants.</p> <p>Self-Regulation Punishment and Dealing with Offenders: TSE Regulation handles any trading participant that violates the law or stock exchange rules in accordance with article 34 of the official trading participant regulations. The “Disciplinary Committee” is an advisory body that, in addition to conducting inquiries, also handles penalty funds, censure, trading suspension, and limiting or canceling trading capabilities, etc.</p> <p>TOKYO AIM's Role as TOKYO PRO-BOND Market SRO: TOKYO PRO-BOND Market-related rules and regulations are provided by TOKYO AIM. TOKYO AIM is an SRO for the TOKYO PRO-BOND Market. Disclosure requirements under the FIEA such as Securities Registration Statements do not apply to the securities listed on the TOKYO PRO-BOND Market.</p> <p>JSDA and TOKYO AIM: Trading on the OTC market is regulated under the JSDA's Self-regulatory Rules and Guidelines for the Bond Market. “TOKYO AIM's TOKYO PRO-BOND Market Listing Regulations and Enforcement Rules” and “JSDA's Self-regulatory Rules and Guidelines for the Bond Market” have a mutually important and complimentary relationship.</p>
Republic of Korea	Korea Financial Investment Association (KOFIA), Korea Exchange (KRX)	<p>KOFIA is an incorporated membership organization created to maintain business order between members, assuring fair trade, protecting investors, and promoting the sound development of financial investment services.</p> <p>Members of KOFIA are financial investment firms, general administration companies, collective investment scheme management companies, bond assessment companies and members under the conditions prescribed by the articles of KOFIA. KOFIA aims to promote fair business practices among member companies, create a fair business culture in the securities trading market, and maximize the function of investor protection. As such, KOFIA undertakes such activities as self-regulation to protect investors and maintain market order among member companies; dispute mediation between members regarding their business activities; registration and management of investment advisers and managers; management of OTC trading for non-listed stocks and non-listed and listed bonds; and establishment of dispute mediation rules for self-mediation of conflicts in the industry.</p> <p>KRX aims to fix and stabilize fair prices in the transactions of securities and exchange-traded derivatives, and facilitate the stability and efficiency of other transactions. It established and operates the stock market, the KOSDAQ Market, and the derivative market.</p> <p>Under the Financial Investment Services and Capital Markets Act, the stock market is established for the trading of securities, such as debt securities, equity securities, beneficiary securities, investment contract securities, derivative-combined securities, and securities depositary receipts.</p>

continued on next page

Table 2.10 continuation

Jurisdiction	Name	Main Functions
Malaysia	Bursa Malaysia, Financial Market Association of Malaysia (ACI Malaysia, quasi SRO)	<p>Bursa Malaysia (Exchange): Securities Commission Malaysia (SC) is the primary regulator of the Exchange. The SC relies on Bursa Malaysia to perform extensive regulatory functions that extend beyond their market operations, including regulating members' business conduct. Bursa Malaysia is also responsible for marketplace surveillance. Bursa Malaysia, on behalf of the SC, supervises and enforces disclosure standards for listed companies. It adopts a thematic approach to achieve the goals and objectives of ensuring effective market regulation. Under this approach, in discharging its regulatory role, Bursa Malaysia will focus on certain key themes. These themes are regularly reviewed to ensure relevance in a progressive environment. The six themes are as follows:</p> <ol style="list-style-type: none"> (1) Enhancing standards of corporate governance among listed issuers, (2) Improving standards of disclosure, (3) Promoting high standards of business conduct and self-regulation among brokers, (4) Enhancing the effectiveness of enforcement, (5) Elevating the level of education and awareness in the industry, and (6) Managing crisis in light of the global financial turmoil. <p>Financial Market Association of Malaysia (ACI Malaysia): The Bond Dealers Association was established in June 1996 to represent the industry's views and work with regulatory authorities to promote the bond market. On the other hand, ACI Malaysia was established in 1974 to monitor, develop and improve industry standards, and to bring them in line with international best practice. ACI Malaysia, whose membership comprises staff from treasury operations of Malaysia's financial institutions (including insurance companies), has adopted a Code of Conduct for the industry. To qualify as a member of ACI Malaysia, a rigorous qualifying examination must be passed. ACI Malaysia qualifies as an SRO in its function and actions; however, ACI Malaysia has not yet been conferred official SRO credentials.</p>
Philippines	PDS Group (Philippine Dealing and Exchange [PDEX])	The Securities and Exchange Commission granted PDEX the license to act as an SRO for the Inter-Dealer, Inter-Professional and Public Markets. As an SRO, PDEX has adopted the PDEX Rules that governs all transactions dealt on the PDEX Trading Platform for fixed-income securities.
Singapore	Singapore Exchange (SGX)	<p>Being a listed exchange and frontline regulator, SGX is considered an SRO. SGX serves as an SRO for the markets and clearing houses that it operates in Singapore. It works closely with relevant regulatory authorities, including the Monetary Authority of Singapore and the Criminal Affairs Department, to develop and enforce rules and regulations to build an enduring marketplace. SGX bears commercial responsibilities in addition to its regulatory duties. While this dual role may present conflicts, SGX has established a framework to manage such conflicts.</p> <p>SGX undertakes various regulatory functions to promote a fair, orderly and transparent marketplace as well as a safe and efficient clearing system. These functions are handled by the following regulatory departments:</p> <ol style="list-style-type: none"> (1) Issuer Regulation, (2) Catalyst Regulation, (3) Member Supervision, (4) Market Surveillance, (5) Enforcement, (6) Risk Management, (7) Clearing Risk, and (8) Regulatory Development and Policy.
Thailand	Thai Bond Market Association (ThaiBMA), Exchanges	<p>ThaiBMA is an SRO licensed to run an efficient market and act as an information center for the secondary bond market. It is responsible for developing the market, establishing market conventions and standards, and acting as a bond pricing agency. It also provides a forum for market professionals to move towards a more mature and sophisticated Thai bond market.</p> <p>The membership of ThaiBMA can be classified into three types, each of which is subject to different membership fees and requirements:</p> <ol style="list-style-type: none"> (1) Ordinary members are dealers. (2) Extraordinary members are inter-dealer brokers. (3) Associate membership is provided for a dealer that has monthly average trading value in the past one year of less than THB100 million per month. <p>Roles and functions of Thai BMA as an SRO: ThaiBMA oversees and monitors the conduct of its members to ensure fairness and efficiency in debt securities trading. It is committed to retaining the confidence of its membership, regulators and investors. It performs market monitoring and surveillance to ensure that all trading activities comply with relevant laws and regulation, and act as the front line to detect any unfair trading</p>

continued on next page

Table 2.10 continuation

Jurisdiction	Name	Main Functions
		practices. It established the Ethics and Code of Conduct for members and traders. It also issues rules and guidelines regarding debt securities trading and good market practice. ThaiBMA is also responsible for bond trader examination and registration and provide them with ongoing education to enhance their professionalism. In addition, it determines enforcement procedures to penalize those who do not comply with the regulation. There is a Memorandum of Understanding (MOU) between the Securities and Exchange Commission and ThaiBMA regarding Bond Market Supervisory Cooperation. Exchanges are regarded as SRO in Thailand.
Viet Nam	Vietnam Bond Market Association (VBMA) In August 2008, the Ministry of Finance approved the list of the Preparation Committee for establishing the VBMA. On 22 May 2009, the Minister of Interior issued an official decision allowing the establishment of the VBMA.	VBMA is regarded as Viet Nam's bond market SRO. VBMA is a non-profit organization aimed to promote the professional and effective development of the Viet Nam bond market, guarantee the legitimate rights and interests of members, and, at the same time, ensure national interests. VBMA's roles and functions: (a) Standardize trading practices and market conventions for bonds and other debt instruments of similar nature in the Vietnamese bond market; (b) Enhance regional and international integration of the bond market, in general, and of the members, in particular, by encouraging the adoption of global best practices by market participants under the conditions of the Vietnamese bond market; (c) Establish the code of conduct and ethics to govern the relationship of market participants to ensure the equality; (d) Improve market expertise and skills by conducting activities to aggregate and analyze bond information, consulting, training and provision of facilitating services to members and other related participants in trading bonds and other debt instruments of similar nature in the Vietnamese bond market; (e) Serve as a forum and bridge for exchanging and updating bond information, for strengthening collaboration and mutual understanding among its members and between its members and the Vietnamese regulatory authorities, as well as related international organizations; to make comments on related policies; to support the state competent bodies in improving policies and legal framework for the bond market in Viet Nam; and (f) Update, aggregate, store and build a database on bond market information, thus helping increase transparency in the Vietnamese bond market.

Source: ADB Consultants, based on research materials and market visit information.

10. Greater Use and Acceptance of Islamic Bond (or Sukuk) Structure

A growing number of jurisdictions now allows or promotes the use of Islamic structure in the issuance of bonds in the region. In addition to Malaysia (which has the largest market), Indonesia, Thailand, Singapore and Hong Kong, Japan will also launch its regulatory framework for issuance of Islamic bonds or *Sukuk* in its bond market. In general, issuer's obligations under a *Sukuk* issue and risk exposures of investors are not materially different from a conventional bond issue. If at all such material difference exists, it is usually well disclosed in the offering documents.

Table 2.11 Existence of the Islamic Finance Market

Jurisdiction	Existence of the Islamic Finance Market
People's Republic of China	No
Hong Kong, China	Yes
Indonesia	Yes
Japan	Yes
Republic of Korea	No
Malaysia	Yes
Philippines	No
Singapore	Yes
Thailand	Yes
Viet Nam	No

Source: ADB Consultants, based on research materials and market visit information.

Implications for the Next Phase of the ASEAN+3 Bond Market Forum Sub-Forum 1 (2012–2013)

1. Improve Information Asymmetry

Through the ASEAN+3 Bond Market Forum (ABMF) Sub-Forum 1 (SF1) market guides and this comparative analysis, it is highly expected that the information asymmetry evident in many places will be improved with the intention to attract more attention from investors outside and within the region.

2. Establish an Asian Version of a Professional Bond Marketplace

In the future, ASEAN+3 may consider establishing a common framework similar to the Eurobond market, possibly modeled on the experiences from the Eurobond market's professionals. However, it is important to understand that the current version of European Union (EU) rules or the Eurobond market framework may not be directly applicable to Asia; hence, it may be necessary to establish an Asian version of such marketplace.

3. Key Objectives for the ASEAN+3 Bond Market Forum Phase 2

Thus, the key objectives for ABMF Phase 2 will be to facilitate cross-border or intra-regional initiatives of issuance and investment of bonds.

4. The Preferred Approach

The preferred approach might focus on a professional-markets or exempted-markets regime (including laws stipulating private placement), which waives full-disclosure requirements for ordinary public offerings to professional investors across jurisdictions. This might lead to the creation of an intra-regional professional marketplace populated only by qualified investors and issuers.

5. Key Outcomes

The ABMF SF1 Phase II key outcome would be an organized and well-documented Intra-regional Professional Market, evident through a bond issuance program with regional standardization of documentation. Such regionally standardized bond issuance program should lead to a regional medium-term note (MTN) program that will be committed to open up the markets to qualified issuers and investors in the region and beyond.

Figure 2.2 Regional Standardization of Documentation

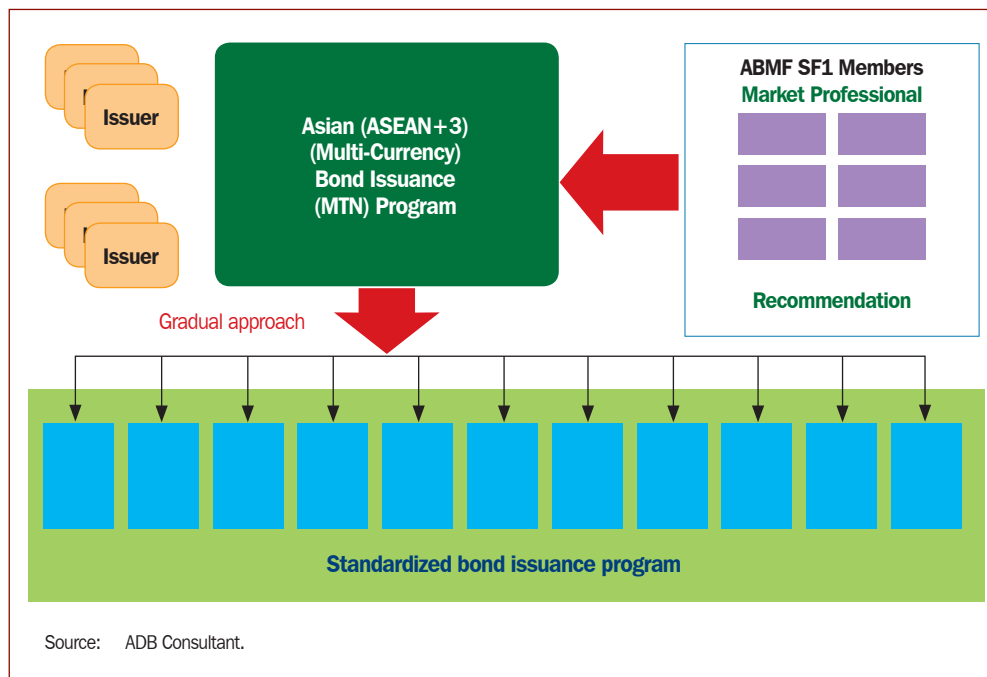

6. Indispensable Conditions for Realizing an Inter-Regional Professional Bond Market

a. **Understanding and recognition among regulators and policy makers.** For this proposal to be accepted, it is important to achieve a common understanding and mutual recognition among regulatory authorities and/or policy makers in the region. Mutually recognizing the common denominators--the concept of professionals, exempted market conditions, and so on--will be important for the discussion.

Figure 2.3 Exempted Market versus Full Disclosure Market

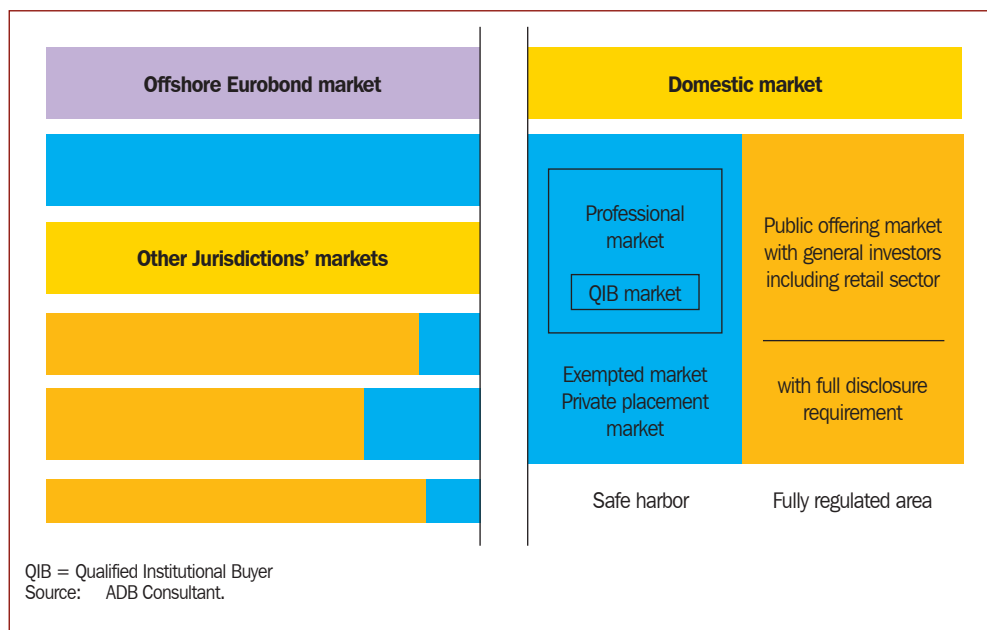

This concept would be similar to, but not completely congruent, with the present state of the US bond market, which is divided into market segments illustrated in Figure 2.4.

Figure 2.4 Comparative Structure of US Domestic and Offshore Markets

Offshore market	Domestic market		
Regulations S, Off-shore Offering (Offer for sale to U.S. residents is prohibited within primary selling-restriction period [40 days] in U.S. in principle)	Rule 144A, Private Placement (“QIBs” [equivalent to a specified institutional investors in Japanese term] only, can be in resale between QIBs only)	Regulation D, Private Placement (Accredited Investors [AIs] [equivalent to qualified institutional investors in Japanese term] only and prohibitions of resale, in principle)	Public Offering (SEC registered offering)

QIB = Qualified Institutional Buyer; SEC = Securities and Exchange Commission
Source: ADB Consultant.

- b. **Taking a gradual approach.** In taking a gradual approach, SF1 will start with what can be done within the scope of current legislation and regulation in each jurisdiction, and without the intention to change the laws and regulations.

7. Expected Result of Mutual Recognition Approach or Convergence Approach

- Member markets or jurisdictions can define a common, general and multi-facetted set of goals or objectives, which are non-binding, but recommended for all markets.
- Jurisdictions would be able to make their own way towards these goals or objectives, i.e., a roadmap or defined path for each market would be required.
- This would allow discussing individual subjects by themselves, together or in parallel, summarizing results in a future report easily.

8. Establishing an Integrated Intra-Regional Professional Bond Market

The first emphasis should clearly be on efforts to allow cross-border transactions within the domestic bond markets, with a goal to arrive at a mutually recognized and accepted framework for these transactions. This envisages a development of the markets from their present, fragmented state (as shown in Figure 2.5) to a group of markets connecting and agreeing on the key elements of a future common market (as shown in Figure 2.6), to ultimately create a common market by combining all the elements in a common marketplace (as shown in Figure 2.7).

Figure 2.5 Status Quo of Asean+3 Bond Markets

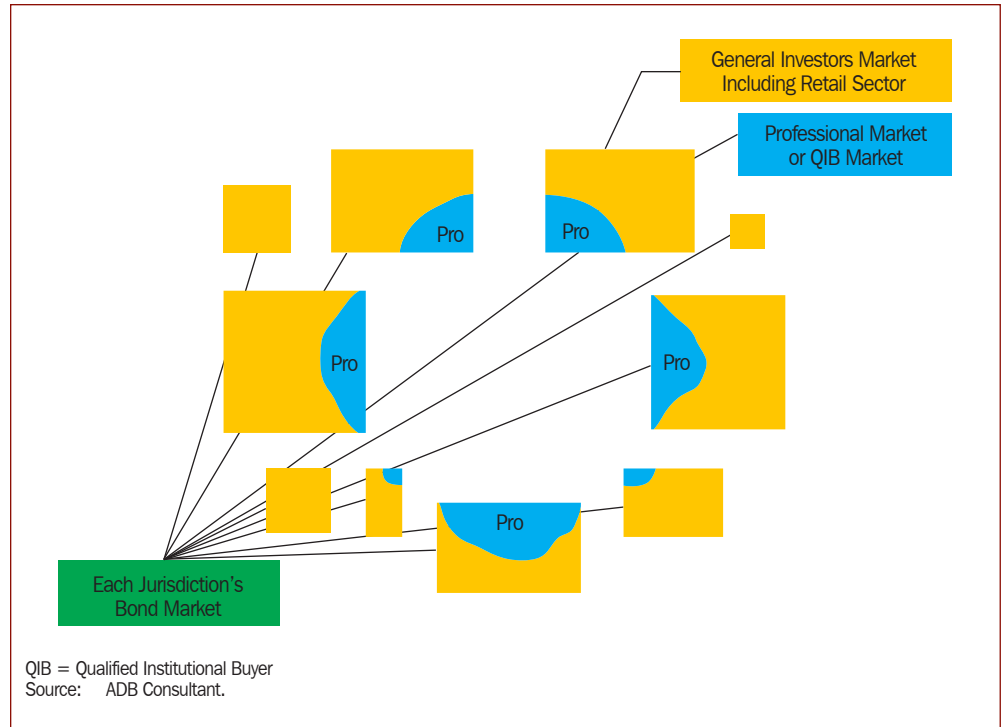

Figure 2.6 Connecting the Professional Market Elements in the Region

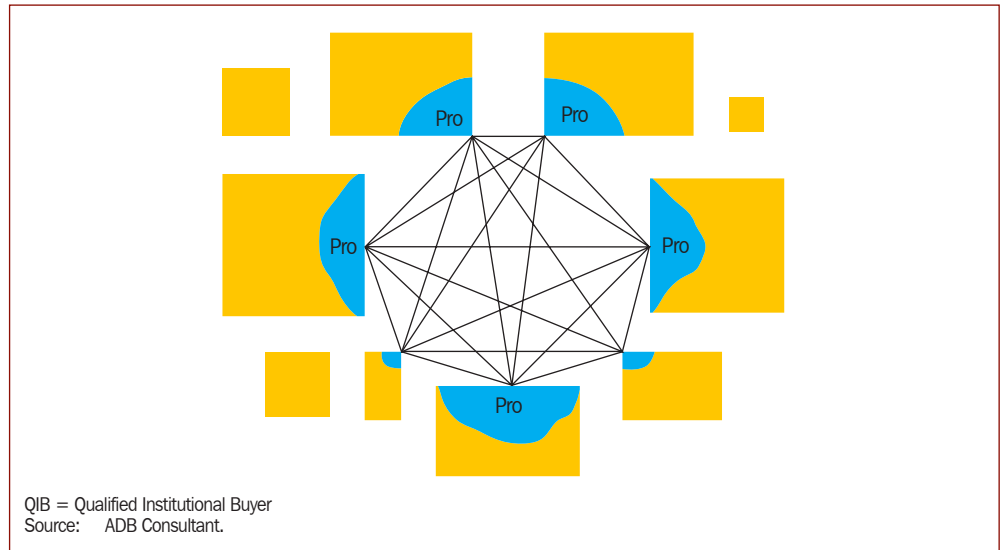

Figure 2.7 Creation of an Intra-Regional Bond Market

The intention is to create a common ‘safe harbor’ for market participants within the ASEAN+3 markets on the basis of the most beneficial regulations. It is, thus, possible to create an integrated intra-regional professional bond market!

With qualified issuers and investors currently restricted to access many domestic bond markets in the region, it should be possible to establish common rules with reasonable efforts.

9. Connecting Each Market

Under the proposed mutual recognition approach, cross-border flows of “Professional Securities” in both primary and secondary markets have to be granted “mutual recognition between jurisdictions with the following exemptions (1–4).”

Mutual (A and B) recognition between jurisdictions:

- (1) Selling restriction on Qualified Institutional Buyer (QIB) in jurisdiction A to invest in resident A issuers’ securities issued in ‘mutually recognized professional securities market’ in jurisdiction B to be exempt.
- (2) Selling restriction on QIB in jurisdiction A to invest in resident B issuers’ securities issued in ‘mutually recognized professional securities market’ in jurisdiction B to be exempt.
- (3) Selling restriction on QIB in jurisdiction A to invest in resident C (other jurisdiction in the region) issuers’ securities issued in ‘mutually recognized professional securities market’ in jurisdiction B to be exempt.
- (4) Resale (secondary market transactions) of the bonds between professional markets in jurisdiction A and B shall not be restricted.

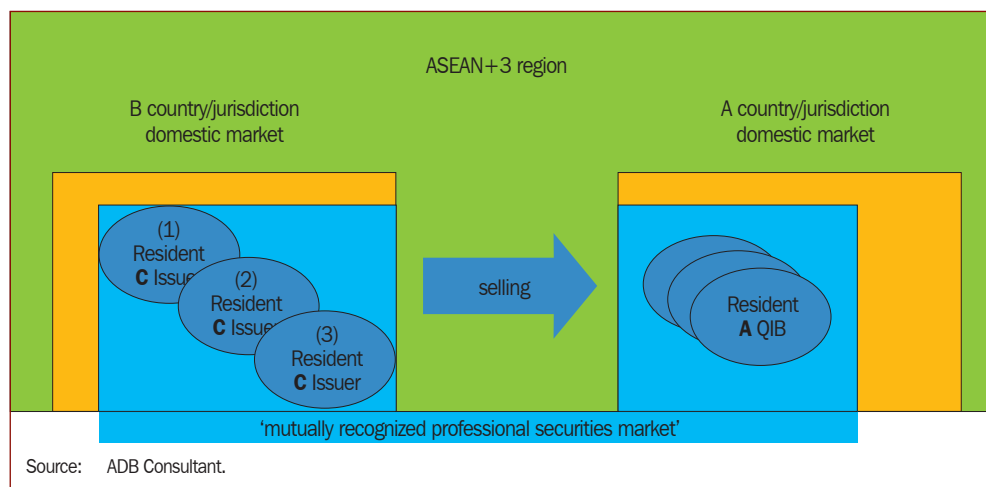
Figure 2.8 Mutual Recognition Examples (1), (2), (3)

Source: ADB Consultant.

10. Envisaged Area of Discussion in ABMF Phase II

With a view on the findings summarized above and the projected development of the ASEAN+3 bond markets, it is envisaged to begin discussions on the following subjects in ABMF Phase II.

(a) *Laws and regulations and Self-Regulatory Organization (SRO) rules in each jurisdiction.*

- (i) Recognize common denominator of the concept of professional investor, sophisticated investor, accredited investor, and QIB, among others;
- (ii) Mutually recognize exempted market conditions, including private placement;
- (iii) Standardize level of information disclosure and/or disclosure rules;
- (iv) Investor protection needs and existing regulations;
- (v) Participants and participants' code of conduct; and
- (vi) Types of securities suitable (for future market).

(b) *Market practices and functions of each domestic SRO*

- (i) Standardize related documentation in offering circulars, etc.;
- (ii) Standardize new issue underwriting procedures;
- (iii) Standardize rules and practices for secondary market making; and
- (iv) Synchronize the concept of eligible issuers.

11. Success Factors of a Mutually Recognized Professional Market

The success of a mutually recognized professional market in the region rests on:

- (i) The degree of maturity of each national securities legislation or law to be applied for investor protection;
- (ii) Established condition of fair price formation in the capital market;
- (iii) Situation of the fixing of the code of conduct among market participants; and

- (iv) The proper functioning of each domestic SRO.

Each jurisdiction will be expected to set its own objectives based on its market condition.

12. Discussion about Self-Regulatory Organizations

A general discussion about a regional SRO in ABMF SF1 is not necessary for the time being, since it is not an indispensable factor for the design of new markets. The realization of a common SRO for ASEAN+3, in the spirit of the International Capital Market Association (ICMA) is, however, a future possibility.

SRO-related discussions are always limited to a single market under one single jurisdiction, complimenting a particular regulator. This is reflected in the International Organization of Securities Commission definition of an SRO. In other words, an SRO only functions as a domestic organization in a country or jurisdiction, being either a domestic governmental body, an exchange or a domestic industrial organization, and performing extensive regulatory functions. Therefore, the SRO function will typically not go beyond “domestic on-shore.”

Unless a country or jurisdiction qualifies as “good securities law for investor protection,” “certain level of governance provided by SROs, etc.,” and “good business conducts in the domestic market”, other countries or jurisdictions may hesitate to do “mutual recognition” of connecting their domestic professional markets.

13. Conclusion

It is envisaged that the work of ABMF Phase II in 2012 and 2013 will focus on research and discussions about the levels and qualities of certain key market elements, such as disclosure, professional investors and issuers, underwriters and broker-dealers with the objective to connect the domestic professional securities market between countries or jurisdictions.

Details of SF1 Contents of Findings

I. Legal Tradition in the Domestic Capital Markets

Table 1. Legal Tradition in the Domestic Capital Markets

Jurisdiction	Original Legal Tradition	Influences
People's Republic of China	Civil law or civil law system	English law, United States (US) law, Japanese law
Hong Kong, China	English law, Common law	
Indonesia	Islamic law, Dutch law, Civil law or civil law system	US law
Japan	Civil law or civil law system	English law, US law, European Union (EU) law
Republic of Korea	Civil law or civil law system	English law, US law, Japanese law
Malaysia	English, Common law Islamic law	
Philippines	Spanish law	US law
Singapore	English law, Common law	(Australian law)
Thailand	Civil law or civil law system	English law, US law, Islamic law
Viet Nam	Civil law or civil law system	French law

Source: ADB Consultants, based on research materials and market visit information

II. Governing Law for Domestic Bond Issuance

Table 2. Governing Law for Domestic Bond Issuance

Jurisdiction	Governing Law for the Resident Issuer	Governing Law for the Non-Resident Issuer • Non-Resident Issuance of Domestic Bond/Medium-Term Note
	Laws and Regulations Related to the Bond Market	
People's Republic of China	Chinese Law	<p>Chinese Law</p> <ul style="list-style-type: none"> Between 2009 and 2010, the ban has been lifted on renminbi-denominated bonds issued by foreign non-banks and local subsidiaries of foreign banks in China. On 6 April 2010, the State Council distributed “comments on the appropriate work to attract foreign capital” and new policies has been laid out; to select foreign capital related to industrial policies, to attract foreign investment in the Midwest region, and to transfer the authority to attract foreign capital to local governments. Among them, supports have been put forward such as initial public offering and listing by foreign companies, and it is explicitly stated that the scope of foreign companies to issue renminbi-denominated bonds in the domestic market will be gradually expanded. <p>1. Major Provisions on Administration of Issuing Treasury Bonds</p> <ol style="list-style-type: none"> <i>Regulations of Treasury bonds of the People's Bank of China</i> (Decree of the State Council [1992] No. 95), Measures for the Examination and Approval of the Qualifications for the Members of the Government Bond Underwriting Syndicates (Order 39 of Ministry of Finance of the People's Republic of China, the People's Bank of China, and China Securities Regulatory Commission), and <i>Circular on Printing and Distributing the Rules for the Issuance of Book-Entry Treasury Bonds by Tender in 2011</i> (CK [2011] No.4), etc. <p>2. Major Provisions on Administration of Issuing Financial Bonds</p> <ol style="list-style-type: none"> <i>Provisions Governing the Issuance of Financial Bonds in the National Inter-bank Bond Market</i> (Order [2005] No. 1 of the People's Bank of China), <i>Administrative Procedures for the Administration on Issuance of Financial Bonds in the National Inter-bank Bond Market</i> (Announcement [2009] No. 6 of the People's Bank of China),

continued on next page

Table 2. continuation

Jurisdiction	Governing Law for the Resident Issuer	Governing Law for the Non-Resident Issuer • Non-Resident Issuance of Domestic Bond/Medium-Term Note
	Laws and Regulations Related to the Bond Market	
	<p>c. <i>Measures for the Administration on Issuance of Subordinated Bonds by Commercial Bank</i> (Announcement [2004] No.4 of the People's Bank of China and China Banking Regulatory Commission),</p> <p>d. <i>Announcement on Relevant Matters Concerning the Issuance of Hybrid Capital Bonds by Commercial Bank</i> (Announcement [2006] No.11 of the People's Bank of China),</p> <p>e. <i>Interim Measures for the Administration on Issuance of Renminbi Bonds by International Development Institution</i> (Announcement [2010] No.10 of the People's Bank of China, Ministry of Finance, National Development and Reform Commission, and China Securities Regulatory Commission), and</p> <p>f. <i>Interim Measures for the Administration of the Issuance of Renminbi Bonds in Hong Kong SAR by Financial Institutions Within the Territory of China</i> (Announcement [2007] No.12 of the People's Bank of China and National Development and Reform Commission).</p> <p>3. Major Provisions on Administration of Issuing Commercial Paper (CP), Super Short-Term CP (SCP) and Medium-Term Notes (MTNs)</p> <p>a. <i>Measures for the Administration of Debt Financing Instruments of Non-Financial Enterprises in the Inter-bank Bond Market</i> (Order [2008] No. 1 of the People's Bank of China) and</p> <p>b. <i>Auxiliary self-regulatory rules formulated by the National Association of Financial Market Institutional Investors.</i></p> <p>Difference in CP may lie in the purpose of the capital raising: project finance (CP) or working capital (SCP).</p> <p>4. Major Provisions on Administration of Issuing Listed Corporate Bonds</p> <p>a. <i>Pilot Rules on the Issuance of Corporate Bonds</i> (Order 49 of China Securities Regulatory Commission) and</p> <p>b. Relevant rules issued by the stock exchanges.</p> <p>5. Major Provisions on Administration of Issuing Enterprise Bonds</p> <p>a. <i>Regulations on Administration of Enterprise Bonds, Circular of National Development and Reform Commission on Promoting the Development of Enterprise Bonds Market and Simplifying the Matters Relating to the Approval for Insurance</i> (FGCJ Document [2008] No.7) and</p> <p>b. <i>Interim Measures for the Administration of Central Enterprise Bonds.</i></p>	
Hong Kong, China	Laws of Hong Kong	<p><i>Laws of Hong Kong</i></p> <ul style="list-style-type: none"> • Issuers of bonds to be listed on the HKSE should also observe the Trading Rules promulgated by the HKEx • For bonds to be listed on the HKSE, issuers should also observe the requirements of the Listing Rules, as well as Parts II and XII of the CO, including section 44B
	<p>Specific laws governing different types of bonds are summarized as follows:</p> <p>1. Government bonds: The issuance of Government bonds is governed by the Loans Ordinance (Chapter 61 of the <i>Laws of Hong Kong</i>). On 8 July 2009, the Legislative Council passed a resolution under section 3 of the <i>Loans Ordinance</i> authorizing the Government to borrow up to a maximum principal amount outstanding at any time of HKD100 billion or equivalent under the Government Bond Program.</p> <p>2. Exchange Fund Notes issued by the Hong Kong Monetary Authority (HKMA) Exchange Fund Notes are issued under the Exchange Funds Ordinance (Chapter 66 of the <i>Laws of Hong Kong</i>).</p> <p>3. Bonds issued by other statutory bodies and government-related corporations Issuance of bonds is governed by the respective ordinances governing the statutory bodies and/or Companies Ordinance, where applicable. For instance, bonds issued by the Airport Authority, which is a statutory body established under the <i>Airport Authority Ordinance</i> (Chapter 483 of the <i>Laws of Hong Kong</i>), are governed by the same ordinance.</p> <p>4. Bonds issued by private entities The issuance of bonds by private entities is governed by sections 41, 44A, 44B and 48A of the CO (Chapter 32 of the <i>Laws of Hong Kong</i>), in addition to the SFO. The terms and conditions of the offers are set out in the offer documents, such as the prospectus. In addition to these, an offer cannot be in breach of other Hong Kong law. For details, refer to the Hong Kong Legal Information Institute (HKLII) website.</p> <p>If the bonds are to be listed on the HKSE, in addition to the CO, issuers have to observe the Listing Rules as mentioned above and other relevant rules promulgated by the HKSE.</p> <p>If participants use the clearing, settlement and custody services provided by the CMU, the debt securities settlement system operated by the HKMA, they should observe the relevant rules promulgated by the HKMA.</p>	

continued on next page

Table 2. continuation

Jurisdiction	Governing Law for the Resident Issuer	Governing Law for the Non-Resident Issuer • Non-Resident Issuance of Domestic Bond/Medium-Term Note
	Laws and Regulations Related to the Bond Market	
Indonesia	Indonesian law	<p>Indonesian law</p> <ul style="list-style-type: none"> MTN programs: Indonesian regulatory framework does not specifically address the registration of MTN, but it regulates the registration procedures for bonds and Sukuk. In order to facilitate the issuance of MTN which allows a firm to issue a series of bonds within a particular period with only one registration statement submission, Bapepam-LK released a new regulation on shelf-registration. <p>Under the current regulatory arrangement, if a bond issuance by non-residents is publicly offered, it must follow similar procedures to the issuance by domestic firms, without any exception. It hinders foreign issuers, especially the requirements on domestic supporting professionals.</p>
	<p>Bonds issued by an Indonesian company or the Government of Indonesia offers in Indonesia through public offering and listed on the Indonesia Stock Exchange shall be governed by the laws of the Republic of Indonesia.</p> <p>Regulation on shelf-registration:</p> <p>There is a rule related to Sustainable Public Offering (Shelf Registration) based on Peraturan Bapepam dan LK Nomor IX.A.15: Penawaran Umum Berkelanjutan, which allows the debit security or bond (efek bersifat utang, EBU) issued to the public in several stages. An issuer has to submit a Registration Statement of Sustainable Public Offering:</p> <ol style="list-style-type: none"> In accordance with Peraturan Bapepam dan LK Nomor IX.A.1, IX.A.2, IX.C.1, IX.C.2 and other related regulations. Equipped with a statement from the issuer or public company and accountant, which states that the referred issuer or public company never experienced failure to pay for a certain period. <p>Moreover, issuers also have to submit reports and information as follows:</p> <ol style="list-style-type: none"> Report of Sustainable Public Offering result to Bapepam-LK at least 5 working days following the date of allotment. Information of reasons for not achieving the target funds (if target acquisition funds are not met). Additional information and supporting documents when issuer is going to issue second and subsequent stages, at least 2 days since the announcement of additional information. 	
Japan	Japanese Law	<p>Japanese Law</p> <ul style="list-style-type: none"> Local MTN programs: Shelf-Registration: Yes. <p>Japanese Law</p> <ul style="list-style-type: none"> Samurai-bond <p>UK (English) law, US (New York [NY]) law, etc.</p> <ul style="list-style-type: none"> International MTN programs: Yes.
	<ol style="list-style-type: none"> The Companies Act defines corporate bonds. In cases where a company will issue bonds in Japan, generally speaking, the company must specify a commissioned company or person for bondholders and entrust the receipt of payments, the preservation of rights of claim on behalf of the bondholders and other administration of the bonds to that manager; provided, however, that this shall not apply in cases where the amount of each bond is JPY100 million or more as prescribed by the Companies Act, and other cases prescribed by the applicable Ordinance of the Ministry of Justice as cases where it is unlikely that the protection of bondholders will be compromised. In the Japanese bond market, the Financial Instruments and Exchange Act (FIEA) distinguishes between a public offering (PO) and a private placement (PP) of securities very clearly, irrespective of whether they are domestic or foreign. In 2008, the Financial Services Agency of Japan revised the FIEA as part of its plan to enhance the competitiveness of Japan's financial and capital markets, establishing the legal framework for markets oriented towards professional investors (an offering system for Specified Investors and Specified Financial Instruments Markets stipulated in the FIEA). This provides the legal framework for the establishment of a new securities market, which is different from the general public offering system and has a wider range of investors than the US Rule 144A market. That is the TOKYO PRO-BOND Market. 	
Republic of Korea	Korean Law	Korean Law
	<p>The "Regulation on Securities Issuance and Disclosure" (RSID), enacted in February 2009, is a Financial Services Commission (FSC) regulation that overhauled the former "Regulation on the Issuance and Disclosure of the Securities" by adding regulatory improvements and additional authorities entrusted by the Financial Investment and Capital Markets Act. To ensure the fairness of securities issuance and investor protection, RSID specifically defines items which investors should be notified of in the form of descriptions on the registration statement and investment prospectus, along with the forms and other documents they should accompany.</p> <p>In particular, when it comes to the registration statements of collective investment securities and asset-backed securities, and the registration statement on mergers, business transfers and split-offs, split-and-mergers, comprehensive exchanges or transfer of stocks, RSID defines different specifics and required documents.</p>	

continued on next page

Table 2. continuation

Jurisdiction	Governing Law for the Resident Issuer	Governing Law for the Non-Resident Issuer • Non-Resident Issuance of Domestic Bond/Medium-Term Note
	Laws and Regulations Related to the Bond Market	
Malaysia	Malaysian law	<p>Malaysian law, (UK (English) law, US (NY) law)</p> <ul style="list-style-type: none"> Local MTN programs: Yes. Transparent requirements have been clearly set out in the guidelines issued by the Securities Commission (SC) Malaysia. International MTN programs: Yes. Full issuing market access on use of international MTN programs is allowed for issuers rated BBB (international rating scale) and above. Transparent requirements have been clearly set out by Bank Negara Malaysia (BNM) and the SC, and such information is made available in the public domain. <p>Specific laws governing different types of bonds are summarized as follows:</p> <p>1. Government bonds The Malaysian “Code of Conduct for Principals and Brokers in the Wholesale Money and Foreign Exchange Markets,” issued by BNM, sets out best market practices, principles and standards to be observed in the Malaysian market. The objective is to uphold market integrity and promote the highest level of professionalism. In addition, BNM also issues rules and guidelines governing the issuance, allotment, interest payment, redemption and settlement of scripless securities under the Fully Automated System for Issuing/Tendering and the Real-Time Electronic Transfer of Funds and Securities System. The aim of these guidelines is to provide a uniform set of rules to promote operational efficiency, market integrity and market transparency.</p> <p>2. Corporate Bonds - Regulation of the Corporate Debt Securities and Sukuk Market The Capital Markets and Services Act 2007, which is administered by the SC, governs all of the corporate bond and <i>Sukuk</i> market. The SC also issues guidelines on the issuance of corporate debt securities and corporate <i>Sukuk</i>, supervises trading activities in the secondary market, and conducts joint examinations and inspections of investment banks together with BNM.</p>
Philippines	Philippine law	<p>Philippine law, (UK (English) law, US (NY) law)</p> <ul style="list-style-type: none"> Local MTN programs: Yes. International MTN programs: Yes. <p>Non-discriminatory basis, no restrictions for both resident and non-resident issuers.</p> <p>The issuance of bonds in the Philippines is governed by the Securities Regulation Code (SRC), the implementation of which is under the Securities and Exchange Commission (SEC).</p> <p>All publicly-offered securities must be registered with the SEC. Exemptions are granted, among others, for securities issued by the government, Bangko Sentral ng Pilipinas (BSP), local government units, banks except their own shares and any foreign government that has diplomatic relations with the Philippines. Exemptions are also granted for securities issued only to primary institutional lenders or qualified buyers as defined in the SRC sections 9 and 10, and the SRC Implementing Rules and Regulations. A credit rating is required to issue corporate bonds and commercial paper.</p> <p>Foreign-denominated debt instruments must be registered with BSP. Government Securities: Several statutes or laws govern bond issuance for the Philippine National Government.</p>
Singapore	Singapore law	<p>Singapore law, UK (English) law, US (NY) law</p> <ul style="list-style-type: none"> Local MTN programs: Yes. International MTN programs: Yes. <p>Restrictions on issuance by non-residents: No. But, Requirements for debentures issuance program set out in Securities and Futures Act (FSA) section 240A. Several Acts of Parliament provide the legal framework for the Singapore securities market:</p> <p>1. Companies Act (Cap 50) All companies in Singapore are governed by the Singapore Companies Act (Cap 50 of the 1994 Revised Edition of the Singapore Statutes). The act (i) provides for the formation (and ultimately termination) of companies; (ii) confers on companies some special features; regulates the relationships between participants in companies and facilitates dealings between companies and outsiders. The Companies Act regulates the ability to issue, and form of, shares and bonds.</p>

continued on next page

Table 2. continuation

Jurisdiction	Governing Law for the Resident Issuer	Governing Law for the Non-Resident Issuer • Non-Resident Issuance of Domestic Bond/Medium-Term Note
	Laws and Regulations Related to the Bond Market	
	<p>2. SFA 2001 (Cap 289) The SFA (A42/2001) was first passed by Parliament on 5 October 2001. Since then, it has been coming into force in parts. Part I (Preliminary), Part VIII (Securities Industry Council and Take-over Offers), Part IX (Supervision and Investigation), Part X (Assistance to Foreign Regulatory Authorities), and Part XV (Miscellaneous, except sections 314 and 342[1] and [3]) came into effect on 1 January 2002. The Monetary Authority of Singapore (MAS) announced on 23 May 2002 that Part XIII of the SFA would come into force on 1 July 2002. Part XIII of the SFA deals with offers of shares, debentures and collective investment schemes. In tandem with the announcement of the enforcement date of Part XIII of the SFA, the MAS has also issued new regulations to supplement Part XIII, of which the main regulations are:</p> <ul style="list-style-type: none"> i. the Securities and Futures (Offers of Investments) (Shares and Debentures) Regulations 2002 (Shares and Debentures Regulations); and ii. the Securities and Futures (Offers of Investments) (Collective Investment Schemes) Regulations 2002 (Collective Investment Schemes Regulations). <p>These regulations also came into force on 1 July 2002.</p>	
Thailand	Thai law	<p>Thai law</p> <ul style="list-style-type: none"> • Local MTN programs: Yes. Shelf filing. • International MTN programs: No. MOF is considering this issue. Applying the international MTN program may work against the Ministry of Finance's (MOF) objectives of balancing the financial system. Furthermore, in instances where domestic liquidity is tight, it may raise the cost of raising funds in the domestic market. • Restrictions on issuance by non-residents: Thailand has opened up the domestic market for non-resident Issuers; however, approval remains subject to MOF and Bank of Thailand's (BOT) consideration (use of proceeds, credit rating, and overall financial system liquidity). The Thai Securities and Exchange Commission (SEC) has adopted the ASEAN standard, which means a Singaporean firm may submit the filing document used in Singapore to the Thai SEC, for bond issuance in Thailand. <p>Governing Laws of Bond issuance, Self-Governing Rules, Related Legal and Regulatory issues behind the Market:</p> <ul style="list-style-type: none"> - SEC Act B.E.2535 and its regulations - BOT Act B.E.2485 - Ministry of Finance – Public Debt Management Office <p>As stated above, SEC Act and SEC notifications govern the issuance of corporate bonds. Government bonds and state-enterprise bonds are issued under the Public Debt Management Act. BOT bonds are issued under BOT regulations.</p>
Viet Nam	Vietnamese law (<i>Securities Law, Enterprise Law, etc.</i>)	<p>Vietnamese law</p> <ul style="list-style-type: none"> • Local MTN programs: No. • International MTN programs: No. • Restrictions on issuance by non-residents: Yes. <p>Regulations related to government bonds/corporate bonds:</p> <p>1. Government bonds:</p> <ul style="list-style-type: none"> a. <i>Circular No. 29/2004/TT-BTC</i> dated 6 April 2004 provides guidelines on the issuance, underwriting and issuance agency for government bonds, government-guaranteed bonds and municipal bonds. b. <i>Circular No. 21/2004/TT-BTC</i> issued by the Ministry of Finance (MOF) provides guidelines on tenders of government bonds, government-guaranteed bonds and municipal bonds via the centralized securities trading market. c. <i>Circular 75-2004/TT-BTC</i> dated 23 July 2004 provides guidelines for issuance of bonds to the public. d. <i>Circular No. 132/2010/TT-BTC</i>, dated 7 September 2010 and issued by MOF, provides guidelines for amendment and supplement to Decision N. 46/2006/QD-BTC. e. <i>Decree 01/2011/ND-CP</i> regulates the issuance of government bonds, government-guaranteed bonds and municipal bonds. It took effect on 20 February 2011, and is expected to boost the development of Viet Nam's bond market. f. <i>Regulation No. 46/2008/QD-BTC</i> dated 1 July 2008 and issued by the MOF to provide rules for government bond trading management at the Hanoi Securities Trading Center (HaSTC, former name of HNX). g. <i>Circular No. 19/2004/TT-BTC</i> dated 18 March 2004 and issued by the MOF to provide guidelines for T-bill and foreign currency bond auctions via the State Bank of Vietnam (SBV). h. <i>Regulation No. 935/2004/QD-NHNN</i> dated 23 July 2004 and issued by the SBV to provide guidelines for T-bill and foreign currency bonds auctions via SBV. <p>Decree 01, which was released to replace Decree 141, will be the legal basis for standardizing activities in the primary government bond market. Generally speaking, Decree 01 contains new measures on the formation of a professional and effective bond market in accordance with standard international practices. This new decree makes important changes such as linking government bonds issuance</p>

continued on next page

Table 2. continuation

Jurisdiction	Governing Law for the Resident Issuer	Governing Law for the Non-Resident Issuer • Non-Resident Issuance of Domestic Bond/Medium-Term Note
	Laws and Regulations Related to the Bond Market	
	<p>activity with public debt management under the new Law on Public Debt Management, effective 2011. The decree also unifies both foreign and local government bond issuance in a single decree instead of two decrees as previously, namely the Decree 141 and Decree 53/2009/ND-CP regarding the issuance of international bonds. In addition, the decree allows government bond issuance to be used to restructure debts and debt portfolios, as well as allowing bond swapping and buying back of bonds before the due date. This is an important step as it paves the way to restructuring the currently small and fragmented bond market. Another positive aspect of the Decree 01 is that it requires the MOF to gradually set up a market-maker system to raise bond market liquidity. Membership conditions have been prescribed by the MOF and are outlined in the decree. Participants in bidding and bond underwriting practices specified in the decree will be considered and recognized as system members provided they satisfy these conditions. The new decree provides clearer and stricter regulations regarding bond issuance and buying, and this will allow for more effective control of capital usage for government bonds. While Decree 141 restricted the use of capital from bond issuance to offset the budget deficit in the annual estimation approved by the National Assembly, Decree 01 allows government bond issuance not only to compensate the temporary deficit budget and to be used as budget expenditure for developing investment, but also to restructure government debts by lending to other organizations, as well as to ensure national financial security. As such, it will help issuers to use the government bond capital more flexibly and effectively and create conditions favorable to maintain continuous and regular issuance to help develop the market.</p> <p>2. Corporate bonds:</p> <p>a. <i>Securities Law 2006 No. 70/2006/QH11</i> is the highest regulatory document governing the listed and public corporate bond issuance and trading. This law stipulates that an issuer wishing to make a public offering of bond must prepare certain documents and follow disclosure requirements, prior to a formal approval by the State Securities Commission. It stipulates the issuer's responsibilities to maintain healthy financial conditions and to meet its financial obligations to bondholders. This law clearly mentions disclosure rules and practices for issuers.</p> <p>b. <i>Enterprise Law 2005 No. 60/2005/QH11</i> paves the path for debt issuance for a shareholding firm by stating that they have rights to issue corporate bonds, convertible bonds and other types of bonds. The law prohibits enterprises from issuing bonds when they do not exhibit a sound financial position, having signals of either low debt servicing capability or below-average profitability. For example, a company is not allowed to issue bonds if:</p> <p>a) It fails to make full repayment for the principal and interest of issued bonds or did not pay or make full payment of due debts in the last 3 consecutive years;</p> <p>b) The average after-tax-profit rate in the last 3 consecutive years is not higher than the interest proposed to pay for bonds to be issued.</p> <p>c. Law amending and supplementing a number of articles of <i>Securities Law No. 62/2010/QH12</i> dated 24 November 2010;</p> <p>d. <i>Circular No. 17/2007/TT-BTC</i> dated 13 March 2007 detailing initial offering (corporate bond included);</p> <p>e. <i>Decision 07/2008/QĐ-NHNN</i> by the State Bank of Viet Nam governs particular credit institutions operating in Viet Nam, including state-run and joint-stock commercial banks, foreign bank branches, and 100% foreign-owned and joint-venture banks.</p> <p>f. <i>Decree 90/2011/ND-CP</i> dated 14 October 2011 and issued by the government to regulate the issuance of corporate bonds; Decree 90 replaced.</p> <p>g. <i>Decree 52/2006/ND-CP</i> dated 19 May 2006 regulating the issuance of corporate bonds, and replaced the concept of the issuance of corporate bond to the international market which was stipulated in Decree 53/2009/ND-CP regulating the issuance of international bonds.</p>	
Source: ADB Consultants, based on research materials and market visit information.		

III. Competent Authority (Regulator) and Self-Regulatory Organizations of Domestic Bond Markets

Table 3. Competent Authority (Regulator) and Self-Regulatory Organizations of Domestic Bond Markets

Jurisdiction	Main Market Authority	Related Market Authorities	Self-Regulatory Organizations
People's Republic of China	<ul style="list-style-type: none"> Inter-bank Bond Market (OTC): People's Bank of China (PBOC) Exchange Market (Shanghai Stock Exchange and Shenzhen Stock Exchange): China Securities Regulatory Commission (CSRC) Foreign Currency Policy: PBOC, State Administration of Foreign Exchange 	<ul style="list-style-type: none"> Treasury Bonds: The State Council, Ministry of Finance, PBOC Financial Bonds: PBOC, China Banking Regulatory Commission Commercial paper (CP), short-term CP and medium-term notes: PBOC Listed Corporate Bonds: CSRC Enterprise Bonds, State-Owned Enterprise Bonds: National Development and Reform Commission 	National Association of Financial Market Institutional Investors

continued on next page

Table 3 continuation

Jurisdiction	Main Market Authority	Related Market Authorities	Self-Regulatory Organizations
Hong Kong, China	Hong Kong Monetary Authority	Securities and Futures Commission	--
Indonesia	Capital Market and Non-Bank Financial Service Supervisory Agency	Bank Indonesia	Indonesia Stock Exchange, Indonesia Clearing and Guarantee Corporation, Indonesian Central Securities Depository
Japan	Financial Services Agency		Tokyo Stock Exchange, TOKYO AIM, Japan Securities Dealers Association
Republic of Korea	Financial Services Commission, Financial Supervisory Service	Bank of Korea	Korea Exchange, Korea Financial Investment Association
Malaysia	Securities Commission Malaysia	Bank Negara Malaysia	Bursa Malaysia, ACI Malaysia
Philippines	Securities and Exchange Commission	Bangko Sentral ng Pilipinas	Philippine Dealing and Exchange
Singapore	Monetary Authority of Singapore		Singapore Exchange
Thailand	Ministry of Finance, Securities and Exchange Commission	Bank of Thailand	Thai Bond Market Association
Viet Nam	State Securities Commission	State Bank of Vietnam	Vietnam Bond Market Association

Source: ADB Consultants, based on research materials and market visit information.

IV. Role of the Self-Regulatory Organizations in Domestic Bond Markets

Table 4. Role of Self-Regulatory Organizations in Domestic Bond Markets

Jurisdiction	Self-Regulatory Organizations (SROs)	Role of the SROs
People's Republic of China	National Association of Financial Market Institutional Investors (Inter-bank Bond Market)	<ul style="list-style-type: none"> Self-Governing Rules and Standardization of Management of the Market In 2007, the NAFMII was officially established. NAFMII is mainly responsible for the self-regulatory management of the over-the-counter (OTC) market (Inter-bank Bond Market). The practice in most recent years proves that NAFMII plays an important role in facilitating market expansion, in guiding and regulating the primary market and the secondary market. 1. Self-regulatory Management System for the Secondary Market The self-regulatory management system for the secondary market was formulated, which standardized trading activities in the OTC market. a. Risk Management of Financial Derivatives Transactions To promote innovations and standardized development of bond derivatives, "the Guidelines on Internal Risk Management of Financial Derivatives Transactions in the Inter-bank Bond Market," and "Guidelines on Credit Risk Mitigation Tools Pilot Business Projects" were promulgated in this regard. "The Master Agreement on Trading Financial Derivative Instruments in the Inter-bank Market of China" by NAFMII (also known as NAFMII Master Agreement) was published and popularized, which addressed a unified and standard text for the OTC financial derivatives market in China. b. Working Guidelines for Market Makers and Code of Conduct for Trading A set of self-regulatory normative documents like "Working Guidelines for Market Makers of the Inter-bank Bond Market," "Self-Regulatory Rules and Code of Conduct for Personnel relating to Trading"

continued on next page

Table 4. continuation

Jurisdiction	Self-Regulatory Organizations (SROs)	Role of the SROs
		<p>were formulated to strengthen self-regulatory management of bond trading behavior of member institutions, regulate the behavior of related traders, maintain the legitimate competitive order of the market, and promote the sound and standardized development of the market.</p> <p>2. Non-Financial Enterprises Instruments Market Management</p> <p>Debt financing instruments of non-financial enterprises saw a rapid expansion and market management has become increasingly standardized. In 2010, debt financing instruments of non-financial enterprises registered and issued in local currency reached RMB1.3 trillion, accounting for 76% of the total amount raised by non-financial enterprise through the bond market during the whole year, according to NAFMII. A series of rules and guidelines regarding issuance and underwriting, information disclosure, credit rating, and market transaction of debt financing instrument were established in succession. Subsequently, full-process supervision and inspection, subsequent management and emergency management, and emergency response mechanism for registration and issuance were correspondingly established and improved.</p> <p>Risk inspection and pressure tests on issued debt financing instruments were regularly conducted, as well as dynamic monitoring on subsequent information disclosure and implementation of commitments after bond issuance. Site inspections to the issuer were also carried out in different levels to prevent market risk substantially.</p> <ul style="list-style-type: none"> <p>Promoting Investors Protection Mechanism</p> <p>NAFMII is vigorously promoting an investors protection mechanism in the non-financial enterprise debt capital market and formulated self-regulatory normative documents such as “Rules for Meetings of Non-financial Enterprise Debt Holders in the Inter-bank Bond Market.” Up until now, the Inter-bank Bond Market has already established a primitive bondholder rights protection system. In 2010, NAFMII formulated the “Rules for the Meetings of the Holders of Debt Financing Instruments of Non-financial Enterprises in the Inter-bank Bond Market,” stipulating that when the issuer (1) fails to pay in full amount of principal or interest, (2) transfers all or part of the repayment obligation, (3) changes the credit enhancing arrangement or credit enhancement agencies, or (4) undertakes capital reduction, merger, division, dissolution, bankruptcy or receivership and other significant cases, a bond holders’ meeting may be convened to protect the legitimate rights and interests of bondholders.</p> <p>Further Deregulation for Issuance of Bonds and Notes in the Inter-bank Bond Market</p> <p>Simplified Qualification of Issuers</p> <p>The qualification of issuers is simplified and the interest can be flexibly determined between issuers and underwriters.</p> <p>The NAFMII enacts market rules on the issuance procedure for short-term financing bill (CP) and the Chinese MTNs, as well as general rules for registration, prospectus and disclosure in the Inter-bank Bond Market based on the Securities Law. In particular, the enactment of the general rule realizes the standardization of bond issuance in the Inter-bank Bond Market and consequently contributes to improving the process of bonds issuance.</p>
Hong Kong, China	–	There are no SROs in the Hong Kong bond market.
Indonesia	Indonesia Stock Exchange (IDX), Indonesia Clearing and Guarantee Corporation (KPEI), Indonesian Central Securities Depository (KSEI)	<p>Each regulates its own areas of operations, subject to Bapepam-LK approval. A number of market associations exist, but none has an SRO status.</p> <p>1. IDX</p> <p>IDX was formed as a result of the merger between the Jakarta Stock Exchange and Surabaya Stock Exchange on 30 November 2007. IDX is regulated by the Bapepam-LK and the Ministry of Finance. All stock exchange regulations are issued by the Bapepam-LK based on Ministry of Finance decrees. IDX facilitates and regulates the Exchange—discusses, prepares, acquires approval from Bapepam-LK, issues and changes Listing Regulations, Trading Regulations and Membership Regulations. It develops a mechanism for organizing and monitoring the Exchange, implements Good Corporate Governance practice based on the IDX Corporate Governance Principles, and develops infrastructure and technologies projects with other SROs. In order to produce professional human resources that can encourage capital market growth in Indonesia, together with other SROs, IDX formed the Association of Indonesian Capital Market Education (P3MI). In 2010, P3MI, in cooperation with the</p>

continued on next page

Table 4. continuation

Jurisdiction	Self-Regulatory Organizations (SROs)	Role of the SROs
		<p>University of Indonesia, founded the Indonesia Capital Market Institute (TICMI). TICMI is focusing on giving education and training skills to aspiring underwriters, investment managers and broker/dealers.</p> <p>Self-Governing Rules: <i>Peraturan Himdasun: Peraturan No.I Keanggotaan Perhimpunan Pedagang Surat Utang Negara. Peraturan Himdasun No.I Keanggotaan Perhimpunan Pedagang Surat Utang Negara. Peraturan Himdasun No.III Pengawasan Perdagangan Surat Utang Negara, Kode Etik Himdasun, dan Master Repurchase Agreement.</i></p> <p>2. Indonesian Central Counterparty (KPEI): The clearing and guarantee are executed by the KPEI.</p> <p>3. Indonesian Central Securities Depository (KSEI): The settlement of transactions is carried out by KSEI.</p> <p>4. Market Associations: The Indonesia bond market has market associations, namely: (a) Inter-Dealer Market Association for Government Securities (HIMDASUN, 26 members comprising domestic and foreign banks, and securities companies). HIMDASUN is holding a license as a market operator for government bonds and has self-governing rules, such as membership, trading, surveillance and master repurchase agreement rules. However, the market operator and self-governing rules function of HIMDASUN is currently inactive. (b) The Indonesian Fixed-Income Dealer Association.</p>
Japan	Japan Securities Dealers Association (JSDA), Tokyo Stock Exchange (TSE), TOKYO AIM,	<p>• JSDA's Self-regulatory Rules and Guidelines for the Bond Market</p> <p>In light of most of the bond transactions being conducted via OTC in Japan, JSDA, the full-fledged SRO for the securities industry in Japan, has issued a variety of rules and market practices for bond market participants. Some of the oldest of the JSDA's self-regulatory rules were introduced as administrative guidance by the financial authority. As the role of the financial authority and the JSDA became clearly separated, these rules fell under the purview of the JSDA, and today function as self-regulatory rules.</p> <p>1. Self-Regulatory Rules</p> <p>JSDA members must comply with these rules. Their coverage ranges from items to be observed in outright transactions (purchase or sale) such as compliance with laws and regulations, maintenance of fairness of transactions, prohibition of extraordinary transactions, a preparation and maintenance of trading records, and reporting of trade turnovers to items to be complied with in special transactions such as repurchase transactions and OTC options transactions (such as requiring contracts, limiting the types of counterparties, etc.). Regarding the rule requiring contracts, JSDA has prepared a model format that has become the de facto standard in Japan. When Association members violate these rules, they are subject to disciplinary action by the Association (if an Association member commits a breach of the rules together with non-Association member (customer), only the Association member is subject to the disciplinary action).</p> <p>Article 16 of JSDA's "Regulations Concerning Publication of Over-the-Counter Trading Reference Prices, etc., of Bonds and Trading Prices" prescribes that Association Members must not affect the acts set forth in each of the following items and any other acts with the aim of compensating for the customer's loss or adding to his/her profit (hereinafter referred to as "Extraordinary Transactions").</p> <p>i. OTC transactions in same-bond issues in which sales and purchases are effected simultaneously at prices favorable to customers or the third parties, but unfavorable to Association Members (the price differential that corresponds to a proper interest based on a difference in the delivery date and the price differential which corresponds to the differential in delivery terms between the cash bonds and registered bonds are excluded);</p> <p>ii. The act of repurchasing or selling at prices favorable to customers performed in purchasing bonds from or selling bonds to customers, or transactions effected on the basis of prior promises that contracts will be cancelled (Gensaki transactions are excluded); or</p> <p>iii. A transaction to be conducted in collusion with a third party promising in advance on the occasion of selling a bond to a customer or purchasing it from a customer that the customer will be sure to gain profits by selling the bond to, or purchasing it from, the third party.</p> <p>The JSDA takes into account market conditions and the practical reality of transactions in establishing, revising and abolishing rules to achieve fair and smooth transactions in the Japanese market, thereby contributing to the protection of investors.</p>

continued on next page

Table 4. continuation

Jurisdiction	Self-Regulatory Organizations (SROs)	Role of the SROs
		<p>During the rule-making procedure, a draft of rules is prepared first through deliberations mainly by Association members, then subjected to public comment and other processes, and finally approved by the Association.</p> <p>2. Guidelines Guidelines are practical rules that JSDA requests participants in the bond market to comply with (thus recognized as “best practice”). As they are merely practices, those who do not comply with them are not penalized. However, as voluntary compliance with these guidelines by the overall market contributes to smooth and efficient transactions, most market participants observe the guidelines. Consequently, the JSDA collects and considers the opinions of market participants when setting new guidelines or revising or abolishing old ones. Currently, JSDA has published guidelines concerning delivery and settlement practices such as “Deadline for Settlement (Cut-off time),” “Handling of Fails Charges,” and “Order Conclusion Practices for Japanese Government Bonds When-Issued Transactions.”</p> <p>3. Others Besides the above, JSDA issues from time to time notices to Association members in advance regarding standard procedures, etc., such as the standard calculation method of accrued interests to eliminate the necessity of getting individual consensus between related parties regarding the unification of procedures among market participants.</p> <ul style="list-style-type: none"> • TSE's Role as an SRO TSE fulfills a number of duties related to the operation of a securities market. It assesses companies on their suitability as listed companies, requires these companies to comply with disclosure requirements so that investors are able to make informed decisions, and provides a market place for those companies' shares to be traded. Pursuant to the Financial Instruments and Exchange Act (FIEA), TSE has self-regulatory functions to maintain a transparent, equitable and reliable market. The provision of such a market helps support a healthy economy. The TSE has two units in relation to its self-regulatory functions: the Listing Regulation Unit and the Compliance Unit. <p>1. Listing Regulation Unit The Listing Regulation Unit is engaged in various activities to ensure the soundness and fairness of the securities market with a focus on issues related to listing. This Unit is comprised of the following two divisions: (i) The Listing Examination Division, which conducts examinations of companies aspiring to list on the TSE to determine each company's listing eligibility. (ii) The Listed Company Compliance Division, which conducts examinations related to information disclosure of companies already listed on the TSE, and determines their eligibility to continue to be listed.</p> <p>2. Compliance Unit The Compliance Unit is engaged in various activities to ensure the soundness and fairness of the securities market with a focus on issues related to trading participants. This Unit is comprised of the following two divisions: (i) The Participants Examination and Inspection Division, which conducts activities such as inspections of banks, securities companies, and other trading participants who possess the qualifications necessary to conduct securities trading on the TSE. (ii) The Market Surveillance and Compliance Division, which conducts detailed investigative activities to ensure that transactions, such as insider trading, market manipulation, and other potentially unfair transactions, do not occur to preserve the fairness and trustworthiness of the securities market.</p> <p>3. Self-Regulation Punishment and Dealing with Offenders TSE regulation handles any trading participant that violates the law or stock exchange rules in accordance with article 34 of the official trading participant regulations. The “Disciplinary Committee” is an advisory body that, in addition to conducting inquiries, also handles penalty funds, censure, trading suspension, and limiting or canceling trading capabilities, etc.</p>

continued on next page

Table 4. continuation

Jurisdiction	Self-Regulatory Organizations (SROs)	Role of the SROs
		<ul style="list-style-type: none"> TOKYO AIM's Role as TOKYO PRO-BOND Market SRO TOKYO PRO-BOND Market rules and regulations are provided by the TOKYO AIM. TOKYO AIM is an SRO for the TOKYO PRO-BOND Market. Among others things, disclosure requirements under the FIEA such as Securities Registration Statements do not apply to the securities listed on the TOKYO PRO-BOND Market. Instead, disclosure requirements stipulated in the rules and regulations of TOKYO AIM, such as the "Specified Securities Information and the Issuer Filing Information", apply as stipulated: In principle, information on listed bonds and on their issuers shall be disclosed pursuant to the TOKYO AIM's "TOKYO PRO-BOND Market Listing Regulations and Enforcement Rules." Also, the listing, initial offering and trading (if any) of the bonds on and in the TOKYO PRO-BOND Market are regulated under TOKYO AIM's "TOKYO PRO-BOND Market Listing Regulations and Enforcement Rules." In addition to these, trading on the OTC market is regulated under the JSDA's "Self-Regulatory Rules and Guidelines for the Bond Market." TOKYO AIM's "TOKYO PRO-BOND Market Listing Regulations and Enforcement Rules" and JSDA's "Self-Regulatory Rules and Guidelines for the Bond Market" have a mutually important and complimentary relationship.
Republic of Korea	Korea Financial Investment Association (KOFIA), Korea Exchange (KRX)	<p>Self-Regulatory Organizations</p> <p>a. KOFIA KOFIA is an incorporated membership organization established for the purpose of maintaining business order between members, assuring fair trade, protecting investors, and promoting the sound development of financial investment services. Members of the Association are financial investment firms, general administration companies, collective investment scheme assessment companies, bond assessment companies and members under the conditions prescribed by the articles of the Association. KOFIA aims to promote fair business practices among member companies, create a fair business culture in the securities trading market and maximize the function of investor protection. As such, KOFIA undertakes such activities as self-regulation to protect investors and maintain market order among member companies; dispute mediation between members regarding their business activities; registration and management of investment advisers and managers; OTC trading management for non-listed stocks and non-listed and listed bonds; and establishment of dispute mediation rules for industry's self-mediation of conflicts.</p> <p>b. KRX KRX is a stock company, which aims to fix and stabilize fair prices in the transactions of securities and exchange-traded derivatives, and facilitate the stability and efficiency of other transactions. It established and operates the stock market, the KOSDAQ Market, and the futures market. Under the Financial Investment Services and Capital Markets Act (FSCMA), the stock market was established for trading of securities, such as debt securities, equity securities, beneficiary securities, investment contract securities, derivative-combined securities and securities depository receipts. The KOSDAQ Market was established for trading specific securities, designated by FSCMA, such as stocks. The futures market was established by the KRX for trading exchange-traded derivatives. The responsibilities of KRX include the establishment and operation of the stock market—the KOSDAQ Market—and the derivatives market; transactions of securities and exchange-traded derivatives; transaction confirmation; debt acquisition; deduction; confirmation of settlement securities, settlement item, and settlement amount; settlement execution guarantees; follow-up measures on settlement failure and settlement instruction as a result of transactions on the securities market and the derivatives market; report and disclosure of a listed corporation; and self-resolution of disputes arising from transactions in the stock market, the KOSDAQ Market and the derivative market.</p>
Malaysia	Bursa Malaysia and Financial Market Association (ACI) Malaysia	<p>Bursa Malaysia and the Financial Market Association of Malaysia are regarded as representations of SROs in the Malaysian market.</p> <p>a. Bursa Malaysia (Exchange) The Securities Commission Malaysia (SC) is the primary regulator. SC relies on Bursa Malaysia to perform extensive regulatory functions that extend beyond their market operations, including regulating members' business conduct. Bursa Malaysia (formerly the Kuala Lumpur Stock Exchange) is now a holding company following demutualization in 2004. It is an SRO that governs its members' conduct and member companies in securities dealings. It is also responsible for marketplace surveillance. Bursa Malaysia, on behalf of SC, supervises and enforces disclosure standards for listed companies.</p>

continued on next page

Table 4. continuation

Jurisdiction	Self-Regulatory Organizations (SROs)	Role of the SROs
		<p>It adopts a thematic approach to achieve its goals and objectives of ensuring effective market regulation. Under the thematic approach in discharging its regulatory role, Bursa Malaysia focuses on certain key themes. These themes are regularly reviewed to ensure relevance in a progressive environment. The six themes are as follows.</p> <ol style="list-style-type: none"> 1. Enhancing standards of corporate governance among listed issuers 2. Improving standards of disclosure 3. Promoting high standards of business conduct and self-regulation among brokers 4. Enhancing the effectiveness of enforcement 5. Elevating the level of education and awareness in the industry 6. Managing the crisis in light of the global financial turmoil <p>b. Financial Market Association of Malaysia (ACI Malaysia): ACI Malaysia was established in 1974 to monitor, develop and improve industry standards, and to bring them in line with international best practice. ACI Malaysia, whose membership comprises staff from treasury operations of Malaysia's financial institutions (including insurance companies), adopted a code of conduct for the industry. To qualify as a member of ACI Malaysia, a rigorous qualifying examination must be passed.</p> <p>ACI Malaysia's key objectives are to:</p> <ul style="list-style-type: none"> • Provide an association for all those who are actively engaged in the financial markets; • Constantly review the techniques and practices of and in the financial markets so as to develop, improve and maintain high standards as comparable to international practices and techniques; <ol style="list-style-type: none"> a. Promote and develop any scheme which may elevate the status and/or advance the interests of the Association; b. Afford opportunities for social and friendly contact amongst members; c. Establish liaison with associations or bodies in overseas countries having similar objects and to seek their assistance to participate in any seminar forum conference meeting or gathering organized by the association overseas; d. Organize talks, seminars conferences meetings and similar gatherings for Members and for the public to improve and update their knowledge of the financial markets; e. Educate, train and assess by examination or otherwise the members of the Association skilled financial markets, to award any certificate to those who successfully complete the examinations and to award prizes to outstanding candidates in examinations; and f. Establish and maintain libraries and collection of publications, research papers, papers delivered at seminars and conferences and other documents and effects whether the same are in written form or otherwise.
Philippines	Philippine Dealing and Exchange (PDEX)	The Securities and Exchange Commission granted PDEX the license to act as an SRO for the Inter-Dealer, Inter-Professional and Public Markets. As an SRO, PDEX adopted the PDEX Rules that governs all transactions dealt on the PDEX Trading Platform for fixed-income securities.
Singapore	Singapore Exchange (SGX)	SGX serves as a frontline regulator for the markets and clearing houses that it operates in Singapore. It works closely with the relevant regulatory authorities, including the Monetary Authority of Singapore and the Criminal Affairs Department, to develop and enforce rules and regulations to build an enduring marketplace. Being a listed exchange and frontline regulator, SGX is considered an SRO. SGX bears commercial responsibilities in addition to its regulatory duties. While this dual role may present conflicts, it has established a framework to manage such conflicts. It undertakes various regulatory functions to promote a fair, orderly and transparent marketplace as well as a safe and efficient clearing system. These functions are handled by the following regulatory departments: Issuer Regulation, Catalyst Regulation, Member Supervision, Market Surveillance, Enforcement, Risk Management, Clearing Risk, Regulatory Development and Policy.
Thailand	Thai Bond Market Association (ThaiBMA)	<p>1. ThaiBMA Members</p> <p>ThaiBMA is a self-regulated organization licensed to run an efficient market and act as an information center for Thailand's secondary bond market. It is responsible for developing the market, establishing market conventions and standards, and acting as a bond pricing agency. It also provides a forum for market professionals to move toward a more mature and sophisticated Thai bond market.</p>

continued on next page

Table 4. continuation

Jurisdiction	Self-Regulatory Organizations (SROs)	Role of the SROs
		<p>a. ThaiBMA Members Membership of ThaiBMA can be classified into three types, each of which is subject to different membership fees and requirements: (1) Ordinary member is a financial institution that has a debt trading license (dealer). (2) Extraordinary member is a company that has an inter-dealer broker license. (3) Associate member is a dealer that has a monthly average trading value in the past year of less than THB100 million per month. In June 2007, membership of ThaiBMA consisted of 52 commercial banks and securities companies.</p> <p>b. Roles and Functions of ThaiBMA as an SRO ThaiBMA oversees and monitors the conduct of its members to ensure fairness and efficiency in debt securities trading. It is committed to retaining the confidence of its membership, regulators and investors. Parts of its SRO functions include the following: 1. Perform market monitoring and surveillance to ensure that all trading activities comply with relevant laws and regulation and act as the front line to detect any unfair trading practices. 2. Establish the Ethics and Code of Conduct for members and traders. 3. Issue rules and guidelines regarding debt securities trading and good market practice. 4. Oversee for bond trader examination and registration and provide them with ongoing education to enhance their professionalism. 5. Determine enforcement procedures to penalize those who do not comply with the regulation. There is a Memorandum of Understanding (MOU) between the Securities and Exchange Commission (SEC) and ThaiBMA on Bond Market Supervisory Cooperation to enhance bond market best practices and ensure that registered traders have adequate knowledge in relevant rules, regulations and ethics, as well as knowledge in the bond market. The MOU became effective on 16 November 2005. The SEC Regulation requires that all securities companies appoint a trader registered with the ThaiBMA for bond trading.</p> <p>Exchanges are regarded as SROs in Thailand.</p>
Viet Nam	Vietnam Bond Market Association (VBMA)	<p>VBMA VBMA is regarded as Viet Nam's bond market self-governing organization. It is a non-profit organization aimed at promoting the professional and effective development of the Viet Nam bond market, guaranteeing the legitimate rights and interests of members and, at the same time, ensuring national interests.</p> <p>1. VBMA's Roles and Functions</p> <p>a. Standardize trading practices and market conventions for bonds and other debt instruments of similar nature in the Vietnamese bond market; b. Enhance regional and international integration of the bond market in general and of the members in particular by encouraging the adoption of global best practices by market participants under the conditions of the Vietnamese bond market; c. Establish the code of conduct and ethics to govern the relationship of market participants to ensure equality; d. Improve market expertise and skills by conducting activities to aggregate and analyze bond information, consulting, training and provision of facilitating services to members and other related participants in trading bonds and other debt instruments of similar nature in the Vietnamese bond market; e. Serve as a forum and bridge for exchanging and updating bond information, for strengthening collaboration and mutual understanding among its members, and between its members and Vietnamese regulatory authorities, as well as the related international organizations; comment on related policies; support state competent bodies in improving policies and legal framework for the bond market in Viet Nam; and f. Update, aggregate, store and build a database on bond market information, thus helping to increase the transparency of the Vietnamese Bond Market.</p> <p>2. History of VBMA In the recent years, the government has been conducting a reform of Viet Nam's financial market. Besides the state's actions, many organizations, businesses as well as the bond market participants have made great efforts to develop the bond market. In November 2006, a group of local and international commercial banks, securities companies, fund management companies,</p>

continued on next page

Table 4. continuation

Jurisdiction	Self-Regulatory Organizations (SROs)	Role of the SROs
		<p>and insurance companies formed the Vietnam Bond Market Forum (VNBF) that was intended to promote bond trading through disseminating and sharing market information, and standardizing commercial activities in the bond market in Viet Nam. The VNBF was directed by an executive board voted for by representatives of the members that were active in the Vietnamese Bond Market. Its executive board worked on a part-time basis, met monthly to discuss on and consent to the VNBF's plan of activities and allocation of work. Over a period of 3 years, VNBF's activities brought initial results for market development. However, operating as a forum had its own limitations such as matters concerning legal status, fundraising, and public recognition. In March 2007, VNBF members collaborated and decided to start procedures to apply for an official permit for the establishment of a professional association in compliance with the laws of Viet Nam, thus helped raise its legal status and financial capacity aimed to strengthen activities to effectively and practically contribute to the development of the bond market in general and bring about benefits to the members in particular. The association was named the Vietnam Bond Market Association (VBMA). At that time, VNBF had a total of more than 50 members and planned to increase the number to 100 or more when it becomes an association. Viet Nam's authorities such as the State Securities Commission, the Ministry of Finance, and the State Bank of Vietnam were all in favor of the transformation from a forum to an association. VNBF officially established its office in May 2007, with an executive board secretary working full-time and is responsible for the operations of the office. The draft charter was first completed in June 2008. In August 2008, the Ministry of Finance (MOF) approved the list of the Preparation Committee for establishing the VBMA. On 22 May 2009 the Minister of Interior issued an official decision allowing the establishment of the VBMA. On 31 December 2009, based on the submission letter of the Association's Chairman, the Minister of Interior decided to approve VBMA's Charter, thus legally enabling the Association to set up its management and execution bodies aimed to execute and coordinate VBMA's activities. The Executive Committee, Standing Committee, VBMA Office commenced operations in early 2010 and have stabilized operations step by step. At the end of November 2010, VBMA had 59 members, with 54 institutional members being local and foreign commercial banks, companies in finance, leasing, securities, fund management, insurance and law consultancy, and five individual members.</p> <p>3. Code of Conduct</p> <p>The Code of Conduct (COC) is intended to be observed by VBMA member organizations, which engage in bond trading activities, whether as part of their market-making or proprietary trading, and/or brokerage services for bond transactions. Its main aim is to set out the principles and standards which VBMA members should follow when conducting bond trading business in a manner that exhibits a high degree of professionalism, integrity, and fairness. Based on the proposal made by the VBMA, the Ministry of Finance officially authorized VBMA to release the COC. To confirm their commitment, 21 full and associate members affixed their signatures to the MOU for adherence to the COC and agreement to supply information to VBMA's website. The signing was done in the presence of representatives from the MOF, State Securities Commission, Hanoi Stock Exchange, the Vietnam Securities Depository, international agencies, and local television. Other members were to sign the MOU in due course as they were not able to attend the MOU signing or they still needed the opinion of their respective legal departments as a procedure before signing.</p>
<p>^a Extraordinary Transactions are defined under article 16 of JSDA's Regulations Concerning Publication of Over-the-Counter Trading Reference Prices, etc., of Bonds and Trading Prices. It prescribes that "Association Members must not affect the acts set forth" in the items enumerated in the regulation "and any other acts with the aim of compensating for the customer's loss or adding to his/her."</p> <p>Source: ADB Consultants, based on research materials and market visit information.</p>		

V. Definition of Securities (Bonds)

Table 5. Definition of Securities (Bonds)

Jurisdiction	Definition of Securities (Bonds)
People's Republic of China (PRC)	<p>There is no original definition of securities. The definition of securities is not confined to a single law. Securities concepts may differ by industry or competent authority in PRC. Recent securities law defines stocks and standard bonds; however, some bonds do not fall under the Securities Law. The Corporation Law and Enterprise Law co-exist and, hence, may either set the rules for issuance of securities, depending on industry, issuer, and type of security. The official definition of securities given in the revised Securities Law of PRC in 2005 is:</p> <p>The present Law shall be applied to the issuance and transaction of stocks, corporate bonds as well as any other securities as lawfully recognized by the State Council within the territory of the People's Republic of China.</p> <p>In case where there is no such provision in the present Law, the provisions of the Corporation Law of the People's Republic of China and other relevant laws and administrative regulations shall be applied. Any listed trading of government bonds and share of securities investment funds shall be governed by the present Law. Where there is any special provision in any other law or administrative regulation, the special provision shall prevail. The measures for the administration of issuance and transaction of securities derivatives shall be prescribed by the State Council according to the principles of the present Law.</p>
Hong Kong, China	<p>For bonds to be listed on the Hong Kong Stock Exchange or cleared through the Central Moneymarkets Unit (CMU), they must satisfy the criteria set out in, among others, the Listing Rules and the CMU Service Reference Manual (which is accessible to CMU members only), respectively.</p> <p>The legal definition of securities is laid down in the Securities and Futures Ordinance (SFO) of the Laws of Hong Kong, and administered by the Securities and Futures Commission.</p> <p>1. Definition of "CMU Instruments" in the CMU Service Reference Manual</p> <p>a. CMU Instruments</p> <p>CMU Instruments are money market and capital market instruments which are specified in the CMU Service Reference Manual as capable of being held within the CMU Service.</p> <p>b. CMU Instruments include:</p> <ul style="list-style-type: none"> • Asset-Backed Securities • Equity Linked Instrument • Fixed Rate Certificate of Deposit • Government Bond • Floating Rate Certificate of Deposit • Bonds • Fixed Rate Notes • Floating Rate Notes • Commercial Papers • Mortgage-backed Securities • Fixed Rate Linked Securities • Floating Rate Linked Securities • Zero Coupon Certificate of Deposit • Zero Coupon Notes • Bills of Exchange other than trade bills • Any other Hong Kong dollar money market and capital market instruments as the [Hong Kong Monetary Authority] may specify from time to time <p>2. Definition of "securities" in the SFO and the Listing Rules</p> <p>a. Section 1 of Part 1 of Schedule 1 to the SFO</p> <p>"Securities" means -</p> <ul style="list-style-type: none"> (i) shares, stocks, debentures, loan stocks, funds, bonds or notes of, or issued by, a body, whether incorporated or unincorporated, or a government or municipal government authority; (ii) rights, options or interests (whether described as units or otherwise) in, or in respect of, such shares, stocks, debentures, loan stocks, funds, bonds or notes; (iii) certificates of interest or participation in, temporary or interim certificates for, receipts for, or warrants to subscribe for or purchase, such shares, stocks, debentures, loan stocks, funds, bonds or notes; (iv) interests in any collective investment scheme; (v) interests, rights or property, whether in the form of an instrument or otherwise, commonly known as securities; (vi) interests, rights or property which is interests, rights or property, or is of a class or description of interests, rights or property, prescribed by notice under section 392 of this Ordinance as being regarded as securities in accordance with the terms of the notice; (vii) a structured product that does not come within any of the paragraphs (i) to (vi) but in respect of which the issue of any advertisement, invitation or document that is or contains an invitation to the public to do any act referred to in section 103(1)(a) of this Ordinance is authorized or required to be authorized, under section 105(1) of this Ordinance,

continued on next page

Table 5. continuation

Jurisdiction	Definition of Securities (Bonds)
	<p>But does not include-</p> <ol style="list-style-type: none"> (1) Shares or debentures of a company that is a private company within the meaning of section 29 of the Companies Ordinance (Cap 32); (2) Any interest in any collective investment scheme that is- <ol style="list-style-type: none"> (1) a registered scheme as defined in section 2(1) of the Mandatory Provident Fund Schemes Ordinance (Cap 485), or its constituent fund as defined in section 2 of the Mandatory Provident Fund Schemes (General) Regulation (Cap 485 sub. leg. A); (2) An occupational retirement scheme as defined in section 2(1) of the Occupational Retirement Schemes Ordinance (Cap 426); or (3) a contract of insurance in relation to any class of insurance business specified in the First Schedule to the Insurance Companies Ordinance (Cap 41); (3) any interest arising under a general partnership agreement or proposed general partnership agreement unless the agreement or proposed agreement relates to an undertaking, scheme, enterprise or investment contract promoted by or on behalf of a person whose ordinary business is or includes the promotion of similar undertakings, schemes, enterprises or investment contracts (whether or not that person is, or is to become, a party to the agreement or proposed agreement); (4) Any negotiable receipt or other negotiable certificate or document evidencing the deposit of a sum of money, or any rights or interest arising under the receipt, certificate or document; (5) any bill of exchange within the meaning of section 3 of the Bills of Exchange Ordinance (Cap 19) and any promissory note within the meaning of section 89 of that Ordinance; (6) any debenture that specifically provides that it is not negotiable or transferable (excluding a debenture that is a structured product in respect of which the issue of any advertisement, invitation or document that is or contains an invitation to the public to do any act referred to in section 103(1)(a) of this Ordinance is authorized, or required to be authorized, under section 105(1) of this Ordinance); (7) interests, rights or property which is interests, rights or property, or is of a class or description of interests, rights or property, prescribed by notice under section 392 of this Ordinance as not being regarded as securities in accordance with the terms of the notice; <p>b. Section 7 of Part 1 of Schedule 1 to the SFO References to securities of a corporation In this Ordinance, a reference to securities (however described) as those of a corporation shall, unless the context otherwise requires, be construed as a reference to securities (having the applicable meaning, whether under section 1 of Part 1 of Schedule 1 to this Ordinance or otherwise) which are-</p> <ol style="list-style-type: none"> (i) issued, made available or granted by the corporation; (ii) proposed to be issued, made available or granted by the corporation; or (iii) proposed to be issued, made available or granted by the corporation when it is incorporated. <p>c. Listing Rules - Rule 1.01 of Chapter 1 of the Rules Governing the Listing of Securities on The Stock Exchange of Hong Kong under this section before the definition</p> <ol style="list-style-type: none"> a. "Debt securities" means debenture or loan stock, debentures, bonds, notes and other securities or instruments acknowledging, evidencing or creating indebtedness, whether secured or unsecured and options, warrants or similar rights to subscribe or purchase any of the foregoing and convertible debt securities. b. "Equity securities" means shares (including preference shares and depositary receipts), convertible equity securities and options, warrants or similar rights to subscribe or purchase shares or convertible equity securities, but excluding interests in a Collective Investment Scheme.
Indonesia	<p>The definition of securities is not confined to a single law.</p> <p>Original relevant definitions found in the Commercial Code left by the Dutch, which remain in force: promissory note (PN), cheque, and bill of exchange.</p> <p>There is no mention of corporate bonds and debt instruments in the Company Law; however, they are often described or covered in the Articles of Association of companies.</p> <p>The clearest definition of securities can be found in the Capital Market Law No. 8 (1995), which states that: "Securities are promissory notes, commercial paper, shares, bonds, evidences of indebtedness, Participation Units of collective investment contracts, futures contracts related to Securities, and all derivatives of Securities."</p> <p>Pursuant to the Elucidation of the Capital Market Law No. 8, "derivatives" refer to rights that are derived from either debt or equity securities, such as options or warrants. An "option" is the right to purchase or sell within a certain time, a specified number of Securities at a specified price. A "warrant" is a security issued by a company giving the holder the right, 6 months or more after the Securities are issued, to subscribe to shares of the company at a specified price.</p> <p>Today, debt instruments can be divided into capital market and money market. The capital market covers bonds while the money market covers PN, medium-term notes (MTNs), commercial papers (CPs), Certificate of Central Bank (Serifikat Bank Indonesia, SBI); most instruments have been introduced by foreign bank participants over recent years.</p> <p>MTN and CP are synonymous for all intents and purposes. Legal treatises exist but there is no statutory definition of these instruments.</p> <p>Commercial bills exist, under the freedom of contract provisions used by non-bank issuers; for bank issues, relevant banking provisions apply.</p>

continued on next page

Table 5. continuation

Jurisdiction	Definition of Securities (Bonds)
Japan	<p>1. The Companies Act defines corporate bonds.</p> <p>2. Existence of uniform legal framework for all types of securities</p> <p>(i) <i>Law Concerning Book-Entry Transfer of Corporate Bonds, Stocks, and Other Securities</i> provides the legal basis for the book-entry transfer system and dematerialization of all securities.</p> <p>(ii) The Japan Securities Depository Center (JASDEC) plays the role of the Central Securities Depository (CSD) in the book-entry transfer system in securities other than government bonds. Under this law, the term CSD means “Designated Depository Institution.” The book-entry bond transfer system participants must observe the rules established by the Depository Institution.</p> <p>3. Dematerialization or Immobilization vs. Physical securities</p> <p>(a) As described above, according to this law and the above system for securities to be distributed, complete dematerialization has been achieved.</p> <p>(b) The <i>Companies Act</i> allows for physical bond certificates to be issued regardless of the book-entry transfer method. However, in this case, distribution in the market cannot be expected, and cannot also be allowed to be owned in tax-exempt status under the Japanese taxation system.</p>
Republic of Korea	<p>In principle, bonds are defined in the <i>Financial Investment Services and Capital Market Act</i> (FSCMA), as “debt securities”, including local government bonds, special bonds, corporate bonds, corporate commercial papers, and other similar instruments. Revisions to the <i>Commercial Act</i> with regards to corporate bonds (to take effect in 2012) provide a basis for corporate bonds diversity. This should resolve the discrepancy in concept about securities between the <i>Commercial Act</i> and the FSCMA. While the former adopts a positive system to define securities, the latter uses a negative system that allows the issue of any new and innovative securities unless prohibited explicitly by law.</p> <p>Under the previous circumstances, there was a lingering controversy whether any new securities permitted under the FSCMA fell under the categories of corporate bonds as defined in the <i>Commercial Act</i>. The updated bill adopts a wider definition for corporate bonds, and it creates a legal basis on which diversified securities can be issued. This will put an end to the controversy.</p>
Malaysia	<p>According to the <i>Capital Markets and Services Act</i> (CMSA), securities are defined as: (a) debentures, stocks or bonds issued or proposed to be issued by any government; (b) shares in or debentures of, a body corporate or an unincorporated body; or (c) unit trusts or prescribed investments, and include any right, option or interest in respect thereof, but do not include futures contracts.</p> <p>Definition of debentures: “Debenture” includes debenture stock, bonds, notes and any other evidence of indebtedness of a corporation for borrowed monies, whether or not constituting a charge on the assets of the corporation, but shall not be construed as applying to any of the following:</p> <p>(i) any instrument acknowledging or creating indebtedness for, or for money borrowed to defray the consideration payable under, a contract for sale or supply of goods, property or services or any contract of hire in the ordinary course of business;</p> <p>(ii) a cheque, banker’s draft or any other bill of exchange or a letter of credit;</p> <p>(iii) a banknote, guarantee or an insurance policy;</p> <p>(iv) a statement, passbook or other document showing any balance in a current, deposit or savings account;</p> <p>(v) any agreement for a loan where the lender and borrower are signatories to the agreement and where the lending of money is in the ordinary course of business of the lender, and any promissory note issued under the terms of such an agreement; or</p> <p>(vi) any instrument or product or class of instruments or products as the Minister may, on the recommendation of the Commission, prescribe by order published in the Gazette.</p>
Philippines	<p>Under section 3 of the Securities Regulation Code, securities are shares, participation or interests in a corporation or in a commercial enterprise or profit-making venture, evidenced by a certificate, contract, instrument, whether written or electronic in character. It includes:</p> <p>a. Shares of stock, bonds, debentures, notes, evidences of indebtedness, asset-backed securities;</p> <p>b. Investment contracts, certificates of interest or participation in a profit sharing agreement, certificates of deposit for a future subscription;</p> <p>c. Fractional undivided interests in oil, gas or other mineral rights;</p> <p>d. Derivatives like option and warrants;</p> <p>e. Certificates of assignments, certificates of participation, trust certificates, voting trust certificates or similar instruments;</p> <p>f. Proprietary or non-proprietary membership certificates incorporations; and</p> <p>g. Other instruments as may in the future be determined by the Securities and Exchange Commission.</p> <p>The Philippine Dealing and Exchange (PDEX) <i>Rules for the Fixed Income Securities Market</i>, as amended (PDEX Rules) define a security as fixed-income securities, including government securities.</p>
Singapore	<p>“Securities” is defined in the Securities and Futures Act (SFA) in section 2(1), section 196A, section 214, and section 239.</p> <p>Section 2(1) Interpretation:</p> <p>2. (1) In this Act, unless the context otherwise requires — “securities” means —</p> <p>(i) debentures or stocks issued or proposed to be issued by a government;</p> <p>(ii) debentures, stocks or shares issued or proposed to be issued by a corporation or body unincorporated;</p> <p>(iii) any right, option or derivative in respect of any such debentures, stocks or shares;</p> <p>(iv) any right under a contract for differences or under any other contract the purpose or pretended purpose of which is to secure a profit or avoid a loss by reference to fluctuations in —</p>

continued on next page

Table 5. continuation

Jurisdiction	Definition of Securities (Bonds)
	<p>(a) the value or price of any such debentures, stocks or shares; (b) the value or price of any group of any such debentures, stocks or shares; or (c) an index of any such debentures, stocks or shares; (v) any unit in a collective investment scheme; (vi) any unit in a business trust; (vii) any derivative of a unit in a business trust; or (viii) such other product or class of products as the Authority may prescribe,</p> <p>but does not include — (a) futures contracts which are traded on a futures market; (b) bills of exchange; (c) promissory notes; (d) certificates of deposit issued by a bank or finance company whether situated in Singapore or elsewhere; or (e) such other product or class of products as the Authority may prescribe as not being securities;</p> <p>Section 196A: Interpretation of this Division 196A. In this Division — “debenture” has the same meaning as in section 2 and, in relation to a business trust, means any debenture issued by the trustee of the business trust in its capacity as trustee of the business trust; “securities” — (a) in relation to a corporation, for the purposes of sections 196 (a) (i) and (b) (i), 198, 202 and 203, means — debentures, stocks or shares issued or proposed to be issued by a corporation; any right, option or derivative in respect of any such debentures, stocks or shares; any right under a contract for differences or under any other contract the purpose or pretended purpose of which is to secure a profit or avoid a loss by reference to fluctuations in — (i) the value or price of any such debentures, stocks or shares; (ii) the value or price of any group of any such debentures, stocks or shares; or (iii) an index of any such debentures, stocks or shares; or such other product or class of products as the Authority may prescribe, but does not include — (AA) futures contracts; (BB) bills of exchange;</p> <p>Section 214: Interpretation of this Division 214. In this Division — “debenture” has the same meaning as in section 2 and, in relation to a business trust, means a debenture issued by the trustee of the business trust in its capacity as trustee of the business trust;</p> <p>Section 239: Preliminary provisions 239. (1) In this Division — “debenture” includes debenture stock, bonds, notes and any other debt securities issued by a corporation or any other entity, whether or not constituting a charge on the assets of the issuer but does not include — (d) a cheque, letter of credit, order for the payment of money or bill of exchange; (e) subject to the regulations made under this Act, a promissory note having a face value of not less than USD100,000 and having a maturity period of not more than 12 months; or (f) for the purposes of the application of this definition to a provision of this Act in respect of which any regulations made thereunder provide that the word “debenture” does not include a prescribed document or a document included in a prescribed class of documents, that document or a document included in that class of documents, as the case may be; “debenture issuance program” means any scheme or arrangement by an entity for the issue of debentures or units of debentures where only part of the maximum amount or aggregate number of debentures or units of debentures under the program is offered initially and a further tranche or tranches may be offered subsequently;</p>
Thailand	<p>a. Definition in the Securities and Exchange Act: The <i>Securities and Exchange Act, B.E. 2535</i>, section 4 stipulates the definition of securities’ as;</p> <ol style="list-style-type: none"> (1) Treasury bills; (2) Bonds; (3) Bills; (4) Shares; (5) Debentures; (6) Investment units which are instruments of evidence representing the rights to the property of a mutual fund; (7) Certificates representing the rights to purchase shares; (8) Certificates representing the rights to purchase debentures; (9) Certificates representing the rights to purchase investment units; (10) Any other instruments as specified by the Securities and Exchange Commission (SEC).

continued on next page

Table 5. continuation

Jurisdiction	Definition of Securities (Bonds)
	<p>“Bill” means any bill issued for raising funds from the public as specified in the notification of the SEC. “Debenture” means any debt instrument or whatever name excluding bills, divided into units, each with equal value and a predetermined rate of return, issued by any company to a lender of purchaser, representing the right of the holder of such instrument to receive money or other benefit.</p> <p>b. Debentures in the Public Limited Companies Act, B.E. 2535 (1992)</p> <p>Chapter XI, Debentures: Section 145. The borrowing by the company by means of the issuance of debentures for offer for sale to the public shall be in accordance with the law on securities and stock exchange, and section 25 shall apply mutatis mutandis. The resolution approving the issuance of debentures under paragraph one shall require the resolution of the meeting of shareholders passed by a vote of not less than three-fourths of the total number of votes of the shareholders attending the meeting and having the right to vote.</p> <p>Chapter III, Offer of Shares for Sale to the Public: Section 24. The offer of shares for sale to the public or to any person shall be in accordance with the law on securities and stock exchange. Section 25. The promoters or the company shall submit to the Registrar a copy of the documents relating to the offer of shares for sale to the public which shall be prepared and submitted to authorities under the law on securities and stock exchange, within fifteen days as from the date of submission to such authorities in accordance with the rules, procedures and conditions prescribed by the Registrar.</p>
Viet Nam	<p><i>Law on Securities:</i> Pursuant to article 3 of the amended and supplemented <i>Securities Law No. 62/2010/QH12</i> and article 6 of <i>Securities Law No. 70/2006/QH11</i>, securities mean evidence from an issuing organization certifying the lawful rights and interest of an owner with respect to an assets or capital portion. Securities may take the form of certificates, book entries or electronic data, and shall comprise the following types:</p> <ul style="list-style-type: none"> ✓ Shares, bonds and investment fund certificates; ✓ Share purchase rights (rights issue), warrants, call options, put options, future contracts, groups of securities and securities indices; ✓ Investment capital contribution contracts; ✓ Other types of securities stipulated by Ministry of Finance.

Source: ADB Consultants, based on research materials and market visit information.

VI. Event of Default and Payment Default

Table 6. Event of Default and Payment Default

Jurisdiction	Definition and related issues in the event of default and payment default
People's Republic of China (PRC)	<p>In PRC, there is no legal definition of default. Generally speaking, the market works on the basis that bonds approved by all competent authorities have a slim chance of default. This remains untested so far. However, the concept of event of default in market practice is increasingly seen as a case of missed payment. The declaration of default remains at the determination of investors, through bondholder meetings.</p> <ol style="list-style-type: none"> 1. Constituting an event of default. As far as recognition of an event of default is concerned, bond issue documentation may not have a definition or sufficient detail. The People's Bank of China has general rules on default in Inter-bank Bond Market instruments, but cover limited security types. A typical definition is as follows: If an issuer cannot pay 90 days after the maturity of the bond, it may constitute an event of default. 2. Timing of default. However, a necessary distinction may be made on the timing of default, i.e. no payment is made on the payment date (during the 24 hours of payment day, it is constituted as “default”), or no payment during business hours of the payment day (i.e., by market close, it is “accidental default”). Usually, default happens at the end of the day. 3. Payment default in the Exchange market/Inter-bank Bond Market, <ol style="list-style-type: none"> (a) Participant default. An event of participant default is either the default in payment of any sum payable to the China Securities Depository and Clearing Corporation (CSDCC) or China Central Depository and Clearing (CCDC), or the default in delivery of securities to the CSDCC or CCDC. (b) Participant-versus-investor default: An event of participant-versus-investor default is either a client default in any of the payment obligations due to the clearing participant (in the case of the Exchange market) or a client default in delivery obligations owed to the clearing participant (in the case of the Exchange market). <p>The clearing participant (in the case of the Exchange market) should recognize and declare an event of default. No case of default of bonds has taken place in the Inter-bank Bond Market yet, and there are no known cases of default for corporate bonds.</p> 4. Covenants or provisions related to default in issue documentation. A cross-default clause is increasingly being introduced in issue documentation, and an acceleration clause is more likely to be included in issue documentation these days. Banks can offset debts against assets of the same account holder; offset (of liabilities versus assets) is permitted by law. A “pari passu clause” is not used. An issuer is the debtor on a specific issue. This is true in particular for subordinate debt.

continued on next page

Table 6. continuation

Jurisdiction	Definition and related issues in the event of default and payment default
Hong Kong, China	<p>1. Terms of Events of Default</p> <p>a. Events of default are a matter of negotiation but, generally, cover non-payment of principal or interest by the issuer, non-compliance with obligations under the bond instruments, non-payment of other indebtedness of the issuer or guarantor when due; the occurrence of certain specified events, for example, change of control, commencement of proceedings against the issuer, passing of an effective resolution for the winding up, administration or dissolution of the issuer or guarantor.</p> <p>b. Events of default are usually found in the trust deed, fiscal agency agreement or deed of covenant (executed by the issuer and guarantor).</p> <p>2. Declaration of Default</p> <p>a. Fiscal agent structure. The noteholders may give written notice to the Issuer to declare that the notes would become forthwith due and payable. This direct right is contained in a deed of covenant.</p> <p>b. Trustee structure. The trustee may at its discretion give notice of default by: Declaring the notes immediately due and repayable (with a certified opinion that the event is materially prejudicial to the interests of the holders of the Notes); or If so directed in writing by the holders of at least 25% in principal amount of the notes, or by an extraordinary resolution of the holders of the notes, declaring all the notes immediately due and repayable.</p> <p>The trustee may institute proceedings against the issuer to enforce repayment of the principal of the notes with accrued interest, and to enforce the provisions of the trust deed. However, noteholders are not entitled to proceed directly against the issuer unless the trustee fails to do so within a reasonable period and such failure is continuing. The noteholders' interests are represented by the trustee.</p> <p>c. When the default happens. The default may happen at any time during the day.</p>
Indonesia	<p>The event of default is a condition where the Issuers can be declared default.</p> <p>Bapepam-LK regulation requires that the procedure to declare default be clearly stated on the Trustee Contract.</p> <p>Pursuant to prevailing Bapepam-LK Regulation, the Trustee Contract shall contain a list of events of default, among others:</p> <ol style="list-style-type: none"> 1. The issuer does not pay the principal and interest of the debt securities and <i>Sukuk</i> on its maturity ; 2. The actual condition about the collateral or the issuer status and its management is different from the information and explanation provided by the Issuer. 3. The issuer has been declared default in relation to credit agreement by one or more of its creditor (cross default). For instance, cross-default is possible, and clauses are used in contracts; grace periods may apply. 4. Suspension of payment (moratorium) of the issuer is declared, and; 5. The issuer does not perform other obligations stated in the trustee contract. <p>Bapepam-LK Rule No. VI.C.4 also requires a Contract of Debt Securities Trustee to contain a clear procedure to solve the event of default or state a default. Usually, when an event of default occurs, the trustee would require the issuer to take corrective action to solve the problem in a specific time period. If the issuer does not take the necessary corrective actions, the trustee may invite all bondholders and conduct a general meeting of bondholders to seek clarification from the issuer regarding the failure.</p> <p>If the meeting does not accept the issuer's explanation and clarification, the meeting may:</p> <ul style="list-style-type: none"> restructure the debt; or declare default status to the Issuer. set another bondholders meeting to decide whether the default will be noticed or not.
Japan	<p>The <i>Commercial Code of Japan</i> stipulates the event of default. In relation to this, under the <i>New Companies Act</i> adopted in June 2005 (enforced in May 2006), a commissioned company for bondholders and its liability and power have been expanded.</p>
Republic of Korea	<p>When an event of default occurs to the issuer, which is one of the major details of an entrustment contract based on relevant provisions in the contract, the trustee announces this information to the trust and Bond Information Service (BIS through www.kofibond.or.kr) operated by the Korea Financial Investment Association, which enables notification to all the investors.</p>
Malaysia	<p>The events of default are usually negotiated terms but the Trust Deed Guidelines issued by the Securities Commission provide for the minimum content requirements for such trust deed. The trust deed and the terms and conditions of debentures must provide for, but should not be limited to, the following:</p> <ol style="list-style-type: none"> 1. a list of all events, the occurrence of any of which would entitle or oblige the trustee to declare the debentures immediately due and repayable (to the extent appropriate and subject to any materiality thresholds and provision for remedy or period of grace which may be negotiated) including the following: <ol style="list-style-type: none"> a. where there is any default in payment of any principal, premium or interest or profit under the debentures or <i>Sukuk</i>; b. where a winding up order has been made against the issuer; c. where a resolution to wind up the issuer has been passed; d. where a scheme of arrangement under section 176 of the <i>Companies Act 1965</i> has been instituted against the issuer; e. where a receiver has been appointed over the whole or a substantial part of the assets of the issuer; f. where there is a breach by the issuer of any term or condition in the debentures or <i>Sukuk</i> or provision of the trust deed or of any other document relating to the issue, offer or invitation in respect of the debentures or <i>Sukuk</i>;

continued on next page

Table 6. continuation

Jurisdiction	Definition and related issues in the event of default and payment default
	<ul style="list-style-type: none"> g. where any other indebtedness of the issuer becomes due and payable prior to its stated maturity or where the security created for any other indebtedness becomes enforceable; h. Where there is a revocation, withholding, invalidation or modification of a license, authorization or approval that impairs or prejudices the issuer's ability to comply with the terms and conditions of the debentures or <i>Sukuk</i>, or the provisions of the trust deed or any other document relating to the issue, offer or invitation in respect of the debentures or <i>Sukuk</i>. <p>2. The powers of the trustee in any of the events described in paragraph (i) include:</p> <ul style="list-style-type: none"> a. the powers of the trustee to declare the debentures or <i>Sukuk</i> immediately due and payable at its discretion; b. the powers of the trustee to declare the debentures or <i>Sukuk</i> immediately due and payable as directed by a special resolution; c. the powers of the trustee to enforce the provisions of the trust deed; d. the circumstances under which the trustee shall be bound to enforce the provisions of the trust deed; and e. the circumstances under which the holders of the debentures or <i>Sukuk</i> are entitled to pursue their rights and remedies.
Philippines	<p>The following descriptions are taken from a sample prospectus of corporate bonds in the Philippines and have been generalized for reference.</p> <ul style="list-style-type: none"> a. Event of Default: The Issuer shall be considered in default under the Bonds and the Trust Indenture or Trust agreement in case any of the defined events (exhibit the examples of the items, each an "Event of Default") shall occur and is continuing: <ul style="list-style-type: none"> Non-payment default, Insolvency Default, Cross default, Winding up proceedings, Representation/Warranty Default, Covenant Default, Breach of Obligations Default, Expropriation Default, Judgment Default, Writ and Similar Process Default, Closure Default, Validity Default, Change of Control Default. b. Consequences of Default: If any one or more of the Events of Default shall occur and be continuing after the lapse of the period given to the Issuer within which to cure such Event of Default under the Trust Indenture or Trust Agreement, if any, or upon the occurrence of such Event of Default for which no cure period is provided, <ul style="list-style-type: none"> (i) the Trustee, upon the written direction of the Majority Bondholders, by notice in writing delivered to the Issuer, or (ii) the Majority Bondholders, by notice in writing delivered to the Issuer and the Trustee, or (iii) the Trustee, in its discretion, in case of a Non-Payment or Insolvency Default, may declare the Issuer in default and declare the principal of the Bonds then outstanding, together with all interest accrued and unpaid thereon and all amounts due thereunder, to be due and payable not later than (for instance) 5 Business Days (the periods provided in the Trust Agreement and in these Terms and Conditions) from the receipt of the declaration of default ("Default Payment Date") with copy to the Paying Agent, who shall then prepare a payment report in accordance with the Registry and Paying Agency Agreement. Thereupon, the Issuer shall pay in accordance with the Registry and Paying Agency Agreement.
Singapore	The events of default are usually negotiated terms in Indenture or Trust deed.
Thailand	<p>Generally, an event of default will be stipulated in the terms and conditions of the debenture. Under Thai law, the terms and conditions are deemed to be an agreement between the debenture issuer and the debenture holder. The following are examples of "events of default" that are normally stipulated in the terms and conditions of a debenture:</p> <ol style="list-style-type: none"> 1. Non-payment: If the Issuer makes a default in the payment of any principal, premium or interest due in respect of the Bonds. 2. Breach of Other Obligation: If the Issuer does not perform or comply with one or more of its other obligations under the Bonds, the Trust Deed or Terms and Conditions. 3. Insolvency: If the Issuer or any of its group entities becomes insolvent or bankrupt, or is unable to pay its debts, stops, suspends or threatens to stop or suspend payment of all or a material part of its debts, by Court order. 4. Enforcement Proceeding: If a distress, attachment, execution, seizure before judgment or other legal process is levied, enforced or sued out on or against any material part of the property, assets or turnover of the Issuer or any of its group entities and is not discharged or stayed within 60 days. 5. Winding-up: If an order is made or an effective resolution passed for the winding-up or dissolution or administration of the Issuer or any of its group entities. 6. Security Enforced: If an encumbrancer takes possession or an administrative or other receiver or an administrator or other similar officer is appointed of the whole or any substantial part of the property, assets or turnover of the Issuer or any of its group entities and is not discharged within 60 days.

continued on next page

Table 6. continuation

Jurisdiction	Definition and related issues in the event of default and payment default
	The debenture holder and/or debenture holder representative (Trustee) will normally recognize and declare the default. The declaration of event of default will be made in accordance with the terms and conditions of the debentures. Thai law is silent as to whether the default will happen during the day or at the end of the day. However, in practice, the default will immediately occur when the debenture holder and/or debenture holder representative (Trustee) declares an event of default. The precedent of a default of debentures normally occurs on the grounds that the debenture issuer fails to pay interest and to repay the principal to the debenture holder when due.
Viet Nam	Bond settlement default: Settlement default in domestic bond transactions traded on an exchange has not occurred yet. If a default occurs in securities or cash settlement, the principles and resolution sequence set out in the settlement regulations of the Vietnam Securities Depository apply. In Viet Nam, there has been no precedent of a default of a corporate issuer on interest and principal payments. However, a bondholder is a creditor of the issuer so, if it happens, the <i>Bankruptcy Law (No. 2112004/QH11)</i> will be applied, and issuer is required to announce the bankruptcy status.

Source: ADB Consultants, based on research materials and market visit information

VII. Existence of the Meeting of Bondholders System

Table 7. Existence of Bondholders Meeting System

Jurisdiction	Existence of bondholder meeting system	Remarks
People's Republic of China	Yes	The declaration of default remains at the discretion of investors, through bondholder meetings. The National Association of Financial Market Institutional Investors (NAFMII) has formulated a self-regulatory management system for the secondary market and promulgated self-regulatory normative documents such as the "Working Guidelines for Market Makers of the Inter-bank Bond Market," "Self-regulatory Rules for Bond Trading in the Inter-bank Bond Market," and "Rules for the Meetings of the Holders of Debt Financing Instruments of Non-financial Enterprises in the Inter-bank bond Market" to strengthen self-regulatory management of members when carrying out trading activities, to regulate the behavior of related trader, maintain the legitimate competitive order of the market, and promote the sound and standard development of the market. In 2010, NAFMII formulated the " Rules for the Meetings of the Holders of Debt Financing Instruments of Non-financial Enterprises in the inter-bank Bond Market ," stipulating that when the issuer (1) fails to pay in full amount of principal or interest, (2) transfers all or part of the repayment obligation, (3) changes the credit enhancing arrangement or credit enhancement agencies, (4) implements capital reduction, merger, division, dissolution, bankruptcy or receivership and other significant cases, a bondholders' meeting may be convened to protect the legitimate rights and interests of bondholders.
Hong Kong, China	Yes	-
Indonesia	Yes	The issuer is responsible for the resolution, based on the general meeting of bondholders' resolution.
Japan	Yes	-
Republic of Korea	Yes	-
Malaysia	Yes	The trustee is responsible for a resolution of a meeting of bondholders. Meetings may be convened at the request of the issuer, trustee or an agreed percentage of debenture holders. There should be a quorum requirement for the transaction of business at the meetings. The quorum for the passing of special resolutions should be explicitly stated in the trust deed.
Philippines	Yes	-
Singapore	Yes	-
Thailand	Yes	-
Viet Nam	No	In Viet Nam, there is no official concept of the meetings of bondholders yet.

Source: ADB Consultants, based on research materials and market visit information.

VIII. The System of Commissioned Company, Bond Representative and Trustee

Table 8. The System of Commissioned Company, Bond Representative and Trustee

Jurisdiction	Name of System	Status
		The System of Commissioned Company, Bond Representative and Trustee
People's Republic of China	Commissioned company	<ul style="list-style-type: none"> Enterprise bonds have this concept; whether it works is untested.
Hong Kong, China	Trustee	<ul style="list-style-type: none"> The appointment of a trustee is done under provisions of the Trust Indenture. The appointment of a trustee is not mandatory. No recent issues or programs featured trustee.
Indonesia	wali amanat (Trustee)	<ul style="list-style-type: none"> Bapepam-LK has guidelines for registration and the duties as Trustee. Trustees must make a contract, <i>perwaliamanatan</i>, with the corporate issuer in accordance with the conditions set out by Bapepam-LK.
Japan	Commissioned person or Commissioned company	<ul style="list-style-type: none"> Stipulated in <i>Companies Act</i>. It shall not be applied in case bond minimum unit is JPY100 million or more.
Republic of Korea	Commissioned company (Revised commercial law will take effect in 2012)/ (Old Commercial Act)	<ul style="list-style-type: none"> Stipulated in the revised <i>Commercial Act</i>. The appointment of a commissioned company is not mandatory. The appointment of a commissioned company is done under provisions of the Trust Indenture.
Malaysia	Trustee	<ul style="list-style-type: none"> Trust deed and trustee is required; based on <i>Trustee Corporation Act</i>. Trustees should be approved by Securities Commission (SC) and listed on SC website. AAA issuers may not need trustee, but such issues need to be approved by SC, and default definitions need to be included in bond issue documentation.
Philippines	Trustee - for Public offering. Facility Agent (FA) - for Private Placement	<ul style="list-style-type: none"> Public offering bond issues typically have a trustee. Corporate bond issuers must appoint a trustee. Private placements require a Facility Agent (FA) that functions as trustee and fiscal agent; in absence of specific regulations, issue documentation would indicate that FA works on behalf of investors.
Singapore	Trustee	<ul style="list-style-type: none"> An issuer must appoint a suitable trustee to represent the holders of its debt securities listed on the Exchange. However, a trustee is not required for a debt issue that is offered only to sophisticated or institutional investors and is traded in a minimum board lot size of SGD200,000 or its equivalent in foreign currencies following listing. (Refer to article 308 "Part IV Trustee and Trust Deed" of Chapter 3 (Debt Securities) of the SGX Main Board Listing Rule for detailed information on the suitability of the trustee and the provisions to be included in the trust deed.)
Thailand	Bondholder Representative or Trustee	<ul style="list-style-type: none"> No trustee concept for bonds; but bond representative (BR). BR has fiduciary duty, plus any duty and liability set out in the terms and conditions; both appointment of BR and actual terms and conditions need to be registered with the Securities and Exchange Commission. Indenture agreements in bond issues can specify a trustee or bondholder representative. This trustee oversees bondholder rights, including the filing of claims and demand payments from the issuer or guarantors. Bondholders can sue and claim for damages from the trustee in case the trustee acts in bad faith or causes damages to bondholders.
Viet Nam	-	<ul style="list-style-type: none"> In Viet Nam, there is no official concept of a bondholder representative, commissioned company, or trustee, yet.

Source: ADB Consultants, based on research materials and market visit information.

IX. Bankruptcy Procedures

Table 9. Bankruptcy Procedures

Jurisdiction	Bankruptcy Procedures
People's Republic of China (PRC)	<p>According to article 7(2) of the <i>Law of the People's Republic of China on Enterprise Bankruptcy</i> (Enterprise Bankruptcy Law), the creditor shall be entitled to ask the debtor to go into bankruptcy.</p> <p>The <i>Enterprise Bankruptcy Law</i> in the PRC is basic, and other relevant additional provisions exist for financial institutions, mainly focused on the debtor-creditor relationship.</p> <p>1. Bankruptcy provisions:</p> <p>In the PRC, the bankruptcy provisions mainly consist of the Enterprise Bankruptcy Law, <i>Company Law</i>, <i>Securities Law</i>, <i>Commercial Bank Law</i> and other relevant laws and regulations. Among them, the Enterprise Bankruptcy Law is the special law regulating bankruptcy. If an enterprise legal person cannot repay due debts and its assets are insufficient to pay off all the debt or it apparently lacks solvency, it should clean up debt according to the Enterprise Bankruptcy Law.</p> <p>After an enterprise is declared bankrupt in accordance with the Enterprise Bankruptcy Law, its collateral property does not belong to the estate, but constitutes repayment of its secured debt, and the remaining assets are included in the estate.</p> <p>2. Settlement of the insolvent assets:</p> <p>Settlement of the insolvent assets are effected in the following order:</p> <ol style="list-style-type: none"> Expenses for bankruptcy proceedings, including: litigation cost involved in a bankruptcy case; expenses for management, realization and distribution of the debtor's assets; and expense involved in the administrator's performance of these duties and paid for his remuneration and expenses for the employees recruited. Community debts, including: debts generated when the bankruptcy custodian or debtor requests the opposite party concerned to perform a contract that is not fulfilled completely by both parties concerned; debts generated from the custodial management of the debtor's assets; debts generated from improper gains; the labor cost for the continuance of business operation, social insurance premiums, as well as other debts as incurred therefrom; debts generated from the damage that occurs during the performance of functions and duties by a bankruptcy custodian or other relevant personnel; and debts generated from any damage due to the debtor's assets. The wages, subsidies for medical treatment and disability and comfort and compensatory funds as owed by a debtor, the fundamental old-age insurance premiums, fundamental medical insurance premiums that shall have been transferred into the employees' personal accounts, as well as the compensation for the employees as prescribed by relevant laws and administrative regulations. The social insurance premiums other than those as prescribed in the aforesaid provisions and tax fees as defaulted by the bankruptcy. The common credits of bankruptcy. Where the insolvent assets are not enough to meet the requirements for liquidation in a same sequence, it shall be distributed in light of the proportion. <p>After the recent financial crisis, and based on lessons learned from the risk of the bankruptcy of large financial institutions, the PRC is developing its "Financial Institution Bankruptcy Management Regulations," aiming to find the resolution to the problem of large financial institutions too big to fail.</p> <p>"The Asia-Pacific Restructuring and Insolvency Guide 2006" explains the restructuring and insolvency frameworks of Asia-Pacific countries.</p>
Hong Kong, China	<p>Any bond issuers going into bankruptcy are subject to the relevant rules set out in the <i>Bankruptcy Ordinance</i> (Chapter 6 of the <i>Laws of Hong Kong</i>). The ranking of a bond vis-à-vis other indebtedness of the bond issuer is determined taking into account the terms and conditions set out in the prospectus, offer documents, term sheets or similar form of documents, as well as section 38 (Priority of debts) of the <i>Bankruptcy Ordinance</i>.</p> <p>The insolvency law in Hong Kong, China is contained in the <i>Companies Ordinance</i>, the <i>Bankruptcy Ordinance</i> and the <i>Companies (Winding-up) Rules</i>. It is based on the law of the United Kingdom (UK), prior to the introduction of the Cork Report. Like the regimes in Australia and New Zealand—also UK-based jurisdictions—it is generally creditor friendly. Out-of-court restructuring, schemes of arrangement, compulsory liquidations, creditors' voluntary liquidations and receiverships are available under the insolvency law. No corporate rescue procedure is currently available.</p>
Indonesia	<p>The Indonesian <i>Bankruptcy Law</i> provides the legal infrastructure for bankruptcy, which can be settled either through court proceedings or informal mechanisms.</p> <p>Creditors may file a bankruptcy petition or submit a lawsuit to the relevant district court based on a breach of contract. During the 1997 Asian financial crisis, the government established the following informal mechanisms to facilitate negotiations between debtors and creditors:</p> <ol style="list-style-type: none"> The Jakarta Initiative Task Force to provide corporate debt restructuring and workout plans to both creditors and debtors. The Indonesian Debt Restructuring Agency to help market-oriented corporations resolve their debt by providing them with fixed exchange rates to strengthen the value of the rupiah. This agency's mandate expired in 2006. The Indonesian Bank Restructuring Agency to facilitate bank and loan restructuring by taking over a bank's non-performing loans and injecting new funds to recapitalize them. <p>Provisions for insolvency are also included in the Capital Market and Financial Institution Supervisory Board (Bapepam-LK) Rulebook.</p>

continued on next page

Table 9. continuation

Jurisdiction	Bankruptcy Procedures
Japan	<p>There are four statutory insolvency proceedings that apply to Japanese corporations. Each can be categorized into one of two general types, depending on whether the aim of the proceedings is to liquidate the company ("Liquidation-type Proceedings") or rehabilitate the company ("Rehabilitation-type Proceedings"):</p> <ol style="list-style-type: none"> 1. Liquidation-type Proceeding <ol style="list-style-type: none"> a. Bankruptcy proceedings (<i>hasan</i>) under the <i>Bankruptcy Act</i>; and b. Special liquidation proceedings (<i>tokubetsu seisan</i>) under the <i>Companies Act</i>. 2. Rehabilitation-type Proceedings <ol style="list-style-type: none"> a. Corporate reorganization proceedings (<i>kaisha kosei</i>) under the <i>Corporate Reorganization Act</i>; and b. Civil rehabilitation proceedings (<i>minji saisei</i>) under the <i>Civil Rehabilitation Act</i>. <p>At the time of the filing of the application for or the commencement of any of those insolvency proceedings or both, depending on the language of the default clause of the relevant bonds, the bonds will be accelerated. If a commissioned company for bondholders has been appointed for the bonds, the commissioned company will act for the benefit of the bondholders as creditors of the issuer in the proceedings. If no commissioned company has been appointed, individual bondholders will be expected to act for themselves in the proceedings.</p> <p>As an alternative to commencing one of the four types of statutory insolvency proceedings above, a Japanese corporation in financial distress may seek to negotiate an out-of-court restructuring of the corporation with its creditors.</p> <p>In the course of such negotiation, bondholders' meeting may determine the amendment to the terms and conditions of the bonds, such as installment repayment of principal amount or reduction of the interest rate, though a court approval will be required to have the decision of the meeting take effect.</p> <p>The resolution requirement for an agenda depends on the content of the agenda.</p> <p>This statutory bondholders' meeting system set out in the <i>Companies Act</i> is applicable only to the bonds issued by Japanese corporate issuers under Japanese law.</p>
Republic of Korea	<p><i>Corporate Restructuring Promotion Act</i> (authority concerned: Financial Services Commission): The purpose of this Act is to facilitate constant corporate restructuring through market functions by providing for matters required in promoting an expedited and smooth corporate restructuring.</p> <p><i>Debtor Rehabilitation and Bankruptcy Act</i> (authority concerned; Ministry of Justice): The purpose of this Act is to efficiently rehabilitate debtors, who are faced with livelihood collapse due to financial difficulties, and their businesses through the coordination of legal relations among interested persons, including creditors, shareholders and equity holders, etc. and to liquidate the assets of debtors who are deemed to find it difficult to rehabilitate or fairly distribute their assets.</p>
Malaysia	<p>Malaysia's laws on bankruptcy have been established in the <i>Companies Act 1965</i>, <i>Bankruptcy Act 1967</i>, and in their respective rules and various amendments.</p> <p>The <i>Companies Act 1965</i> contains provisions for insolvency, rehabilitation, appointment of receivers, and winding-up procedures for companies.</p> <p>Specific laws governing industries may also have provisions governing insolvency of a company (e.g., the <i>Banking and Financial Institutions Act 1989</i> for banks).</p> <p>The <i>Bankruptcy Act 1967</i> covers bankruptcy laws for individuals.</p> <p>"The Asia-Pacific Restructuring and Insolvency Guide 2006" explains the restructuring and insolvency frameworks of Asia-Pacific countries in greater detail.</p>
Philippines	<p>Bankruptcy procedures are governed primarily by the <i>Financial Rehabilitation and Insolvency Act of 2010 (FRIA)</i> and the <i>Civil Code of the Philippines</i>. The Supreme Court will soon issue the implementing rules of FRIA. FRIA was passed into law on 18 July 2010. The FRIA repealed the country's 101-year old <i>Insolvency Law (Act 1956)</i>, which was enacted in 1909. FRIA provides for three different modes of rehabilitating an insolvent corporate debtor, namely: (a) court-supervised rehabilitation, (b) pre-negotiated rehabilitation, and (c) out-of-court or informal restructuring or rehabilitation. In a court-supervised rehabilitation proceeding, the court appoints a receiver and determines which claims against the debtor are valid. A rehabilitation plan is to be agreed upon by the debtor and creditors representing more than 50% of the claims of each class of creditors. If the plan is not finalized or approved by the court, the debtor will be liquidated. During the pendency of the proceedings, all claims against the debtor are suspended, and taxes as well as fees due from the debtor to the government are deemed waived. The amount of debt reduced or forgiven will not be subject to tax. In a pre-negotiated rehabilitation, a debtor seeks court approval of a rehabilitation plan previously contracted by it with creditors representing at least 2/3 of its total liabilities (and at least 67% and 75% of its secured and unsecured obligations, respectively). Claims against the debtor are suspended while the proceedings are pending in court. In the out-of-court mode, the debtor and creditors representing at least 85% of the debtor's total liabilities (and at least 67% and 75% of its secured and unsecured obligations, respectively) are to agree on a restructuring or rehabilitation plan. This plan becomes binding on the contracting parties, as well as on the other creditors of the debtors. During negotiations, a standstill of up to 120 days may be approved by creditors holding more than 50% of the total claims. The FRIA does not cover banks, insurance companies and pre-need companies, as these entities are governed by other laws and regulations. FRIA also provides for the liquidation of insolvent juridical debtors. Voluntary Liquidation is initiated by the debtor via a verified petition, or a verified motion in court-supervised or pre-negotiated rehabilitation proceedings. Rehabilitation proceedings may also be converted into liquidation proceedings when the rehabilitation court finds that the debtor is insolvent and there is no substantial likelihood for the debtor to be successfully rehabilitated, or when the</p>

continued on next page

Table 9. continuation

Jurisdiction	Bankruptcy Procedures
	<p>rehabilitation plan is not confirmed by the rehabilitation court within 1 year from filing of the petition, or when the rehabilitation proceedings is terminated due to failure of rehabilitation or dismissal of the rehabilitation petition for reasons other than technical grounds, or at any time upon the recommendation of the rehabilitation receiver that the rehabilitation of the debtor is not feasible. Involuntary Liquidation is initiated by three or more creditors whose aggregate claims amount to at least PHP1 million or at least 25% of the subscribed capital stock or partners' contribution, whichever is higher, also via a verified petition or a verified motion in a court-supervised or pre-negotiated rehabilitation proceedings. FRIA has a special provision for the liquidation of a securities market participant. It recognizes the power of a regulatory agency or self-regulatory organization to liquidate trade-related claims of clients or customers of a securities market participant which, for purposes of investor protection, are deemed to have absolute priority over all other claims of whatever nature or kind insofar as trade-related assets are concerned. Trade-related assets include cash, securities, trading right, and other assets owned and used by the securities market participant in the ordinary course of its business. For insolvent individual debtors, the FRIA provides for</p> <ol style="list-style-type: none"> (a) the suspension of payments, when the debtor possesses sufficient properties to cover all his debts but foresees the impossibility of meeting them when they respectively fall due, (b) voluntary liquidation, initiated by the debtor who does not have sufficient properties to cover his liabilities and owes debts exceeding PHP500 thousand, and (c) Involuntary liquidation, initiated by creditors with claims aggregating at least PHP500 thousand. <p>FRIA requires that the Liquidation Plan and its implementation shall ensure that the concurrence and preference of credits as enumerated in the <i>Civil Code of the Philippines</i> and other relevant laws shall be observed, unless a preferred creditor voluntarily waives his preferred right. Credits for services rendered by employees or laborers to the debtor shall enjoy first preference under article 2244 of the Civil Code, unless the claims constitute legal liens under articles 2241 and 2242 thereof.</p> <p>"The Asia-Pacific Restructuring and Insolvency Guide 2006" provides details on the restructuring and insolvency frameworks of Asia-Pacific countries.</p>
Singapore	<p>Singapore has a well-established, comprehensive corporate bankruptcy and insolvency statutory framework, which is largely set forth in the <i>Companies Act</i>.</p> <p>The corporate bankruptcy and insolvency laws primarily stem from English and Australian sources, and remain similar in many respects to the legislation of those jurisdictions.</p> <p>Singapore laws have progressively developed over the years to keep pace with developments in other jurisdictions.</p> <p>"The Asia-Pacific Restructuring and Insolvency Guide 2006" explains the restructuring and insolvency frameworks of Asia-Pacific countries, including information on Singapore.</p>
Thailand	<p>According to the <i>Bankruptcy Act B.E. 2483 (1940)</i>, corporate bondholders shall be treated as ordinate creditors. In addition, under the <i>Securities and Exchange Act B.E. 2535 (1992)</i> and "Trust for Transactions" in the <i>Capital Market Act B.E. 2550 (2007)</i>, if the issuer of corporate bonds sets up a reserved account or sinking fund in a form of trust, bondholders shall have bankruptcy remoteness and ultimately shall have the rights in that trust property. When the company goes bankrupt, corporate bondholders shall have the right to the property of the company to receive performance of an obligation due to them according to the following ranks:</p> <ol style="list-style-type: none"> 1. Bondholders for which the issuer has set up reserve account or sinking fund in a form of trust 2. Secured creditors 3. Unsecured creditors <p>There is no explicit legal protection of the netting procedures as well as the settlement finality when insolvency is involved. Consequently, it cannot be ruled out that transactions settled in the Thailand Securities Depository will not be protected against a court decision in the event a participant becomes insolvent.</p>
Viet Nam	<p>In Viet Nam, a bankruptcy of a corporate bond issuer has not occurred yet.</p> <p>If it happens, the <i>Bankruptcy Law 2004</i> will be applied.</p> <p>"The Asia-Pacific Restructuring and Insolvency Guide 2006" provides details on the restructuring and insolvency frameworks of Asia-Pacific countries. According to this Guide, prior to October 2004, the legal framework for bankruptcy in Viet Nam consisted of the <i>Law on Business Bankruptcy</i> dated 30 December 1993, the <i>Decree on Business Bankruptcy</i> dated 23 December 1994, and various subordinate legal instruments (collectively referred to as the 'old Bankruptcy Law').</p> <p>The old <i>Bankruptcy Law</i> was generally considered to be deficient and, by the end of the East Asian economic crisis in 2002, the courts had received only 151 petitions, with a mere 46 of these resulting in a declaration of bankruptcy. The old <i>Bankruptcy Law</i> was replaced by the <i>Bankruptcy Law</i> dated 15 June 2004, which came into effect on 15 October 2004, and the <i>Resolution of the Judges' Council of the Supreme People's Court guiding the implementation of the Bankruptcy Law</i> dated 28 April 2005 (collectively referred to as the 'Bankruptcy Law').</p> <p>The Bankruptcy Law applies to enterprises and cooperatives established in accordance with Vietnamese law. The list of enterprises covered is extensive and includes state-owned enterprises (SOEs), enterprises belonging to social and political organizations, limited liability companies, joint stock companies, partnerships, private enterprises and foreign-invested enterprises (FIEs). The Bankruptcy Law does not apply to individuals or certain small business entities such as registered family and household businesses. The law stipulates that additional regulations will be issued to address the insolvency of enterprises in certain specific sectors, including:</p>

continued on next page

Table 9. continuation

Jurisdiction	Bankruptcy Procedures
	<ul style="list-style-type: none"> (i) national defense and security; (i) finance, banking and insurance; and (ii) other sectors directly providing public utility products and services. <p>To date, however, such detailed laws have not been issued. Voluntary liquidation and restructuring are addressed by separate legal frameworks depending on the type of enterprise. An enterprise experiencing financial difficulties may consider restructuring or terminating its operations in accordance with the relevant legislation.</p> <p>Chapter VII of the <i>Law on Enterprises</i>, which governs limited liability companies, joint stock companies, partnerships and private enterprises, deals with the dissolution and reorganization of enterprises and allows for the division, separation, consolidation, merger and conversion of enterprises.</p> <p>The <i>Law on Foreign Investment</i> governs the dissolution, division, demerger, consolidation and conversion of FIEs.</p> <p>Both the <i>Law on Enterprises</i> and the <i>Law on Foreign Investment</i> were replaced by a unified <i>Law on Enterprises</i> which was passed on 29 November 2005 and became effective on 1 July 2006, and which contains similar provisions.</p> <p>Chapter VII of the <i>Law on State-Owned Enterprises</i> deals with the reorganization and dissolution of SOEs.</p>
Source: ADB Consultants, based on research materials and market visit information.	

X. Form of Bonds (Settlement Method) and Status (Bearer/Registered)

Table 10. Form of Bonds (Settlement Method) and Status (Bearer/Registered)

Jurisdiction	Form of Bonds (Settlement Method)	Status (Bearer/Registered)
People's Republic of China	<ul style="list-style-type: none"> • Book-entry form 	Registered. (Bonds are generally getting scripless in a central register and registered in the account holder's or bondholder's name; some older bearer bonds may still exist.) (For China Central Depository and Clearing [CCDC]-settled bonds in the China Inter-bank Bond Market, management of the bearer-bond library was centralized by CDCC in 1998, and 2001 saw the end of bearer bonds.)
Hong Kong, China	<ul style="list-style-type: none"> • Book-entry form (dematerialized) for Exchange Fund paper, and • Global note form for corporate bonds 	Bearer/Registered
Indonesia	<ul style="list-style-type: none"> • Book-entry (from 2000) • Physical certificates still exist (issued prior to 2000) 	Bearer/Registered
Japan	Book-entry form (Completely dematerialized, except for a few non-central securities depository (CSD)-settled private placed notes)	Registered
Republic of Korea	<ul style="list-style-type: none"> • Book-entry form 1. Dematerialized securities Securities which are not issued in paper form and whose ownership is held and transferable by book entry in a ledger maintained by a CSD or account management institution. 2. Immobilized securities Physical securities and non-certificated securities held and transferred by book entry in a ledger maintained by a CSD or account management institution. 	Bearer/Registered
Malaysia	<ul style="list-style-type: none"> • Listed bonds: Book entry at Bursa Malaysia Depository • Unlisted debt securities: Book entry at Bank Negara Malaysia 	Basically, registered. Cagamas papers are unsecured bearer bonds issued by Cagamas, the national mortgage corporation established in 1986 to promote the secondary mortgage market in Malaysia.

continued on next page

Table 10. continuation

Jurisdiction	Form of Bonds (Settlement Method)	Status (Bearer/Registered)
Philippines	<ul style="list-style-type: none"> Government Securities: Book entry in Registry of Scripless Securities or in Philippine Depository and Trust Corporation (PDTC) Scripless Corporate Bonds: Book entry in PDTC Physical Corporate Bonds: Endorsement and actual delivery of physical certificates with duly notarized Deed of Assignment 	Bearer/Registered. Dematerialization/Immobilization versus Physical Securities: Both equities and debt securities are legally recognized in physical and dematerialized form. In the organized market for debt securities, however, debt securities must be in dematerialized form and cannot be listed if the same are still in physical form, even if immobilized.
Singapore	<ul style="list-style-type: none"> Book entry for government bonds The Central Depository Pte. holds universal certificates for physical bonds 	Bearer/Registered. A foreign issuer is normally required to appoint a paying agent in Singapore while the debt securities are quoted on the Exchange and upon the issue of debt securities in definitive form. The Exchange may accept other arrangements to enable definitive certificate holders of the bearer debt securities in Singapore to be paid promptly.
Thailand	<ul style="list-style-type: none"> Book entry Promissory notes (PNs) and commercial papers are physical, bearer instruments. <p>In accordance with sections 225 to 228 of the <i>Securities and Exchange Act (SEA)</i>, immobilization in the Thailand Securities Depository (TSD) system has been arranged through the transfer of securities by book entry.</p> <p>The transfer of securities by book entry shall be deemed to be the delivery of securities, which constitutes the legal basis for the validity of securities transfer under section 199 and section 51 of the SEA. Moreover, securities transferred into the name of the TSD shall be presumed to be securities held by the TSD on behalf of its members or for any customers of its members.</p> <p>However, there is no explicit legislation for the dematerialization of securities.</p>	Bearer/Registered. PNs are physical, bearer instruments issued by banks and other financial institutions.
Viet Nam	<ul style="list-style-type: none"> Book entry Municipal bonds are physical, bearer instruments. Corporate bonds and state-owned enterprises bonds can be held in bearer or registered form. Listed corporate bonds have to be deposited at the Vietnam Securities Depository to be eligible for trading on the Exchanges 	Bearer/Registered

Source ADB Consultants, based on research materials and market visit information.

XI. Exchangeability of Scripless Bonds to Physical Bonds

Table 11. Exchangeability of Scripless Bonds to Physical Bonds

Jurisdiction	Exchangeability of Scripless Bonds to Physical Bonds
People's Republic of China	No
Hong Kong, China	Yes
Indonesia	Yes
Japan	No
Republic of Korea	Yes
Malaysia	Yes
Philippines	Yes
Singapore	Yes
Thailand	Yes
Viet Nam	Yes

Source ADB Consultants, based on research materials and market visit information.

XII. Transfer of Securities (or Property Rights) and Finality of Settlement of Scripless Bonds

Table 12. Transfer of Securities (or Property Rights) and Finality of Settlement of Scripless Bonds

Jurisdiction	Transfer of Securities (or Property Rights)	Finality of Settlement
People's Republic of China (PRC)	<p>Transfer of Entitlement and Ownership of Securities</p> <p>1. First, according to the “Securities Law of PRC revised in 2005: Article 157,” a securities registration and clearing institution (such as China Securities Depository and Clearing Corporation [CSDCC], China Central Depository and Clearing [CCDC] or Shanghai Clearing House) shall perform the following functions:</p> <ol style="list-style-type: none"> The establishment of securities accounts and settlement accounts; The custody and transfer of securities; The registration of roster of securities holders; The settlement and delivery for listed securities trading of a stock exchange; The distribution of securities rights and interests on the basis of the entrustment of issuers; The handling of any inquiry relating to the aforesaid business operation; and Any other business operation as approved by the securities regulatory authority under the State Council. <p>2. Second, a securities registration and clearing institution (such as CSDCC or CCDC) takes the following measures to guarantee a sound operation of its business: A securities registration and clearing institution’s (such as CSDCC/CCDC) rules are formulated to regulate securities depository and clearing activities, protect the rights and interests of investors, maintain the order of the depository and clearing activities, mitigate securities depository and clearing risks, and promote an efficient securities market in accordance with the <i>Securities Law of the People’s Republic of China, Company Law of the People’s Republic of China</i> and other applicable laws and regulations.</p> <p>3. Security Account Management System Securities shall be credited to the beneficiary’s account, unless otherwise provided by applicable laws, regulations and requirements of the China Securities Regulatory Commission that securities will be credited to the nominal holder’s account. The investor shall apply with the CSDCC or CCDC for establishing the securities account for recording the balance and changes of securities held by the investor with reliable, accurate and complete account opening information. The CSDCC or CCDC may establish the securities account directly or designate a qualified securities company as the account-opening agent.</p> <p>4. Securities Registration System New securities are typically issued in electronic form. The securities issuer shall make the initial public offer holder register and other relevant materials available for the CSDCC or CCDC to establish the original holder register of such securities. The issuer is responsible to guarantee the legality, authenticity, accuracy and integrity of materials it provides to the CSDCC or CCDC. The CSDCC shall maintain the holder register of a listed security according to the settlement records of securities transactions. In case of securities transfer in the nature of negotiated or forced transfer, heritage, donation and government transfer, etc., the CSDCC or CCDC shall process changes in the balance in securities accounts and the shareholder register in line with the operating rules.</p> <p>5. Central Depository System To participate in securities investment, the investor shall enter into a securities brokerage, custody and clearing agreement with the securities company. The CSDCC or CCDC shall prescribe and disseminate the mandatory provisions in relation to the securities depository and clearing service in the securities brokerage, custody and clearing agreement, which shall include, but not limited to:</p> <ol style="list-style-type: none"> The Securities Company shall place the trading instructions upon client’s entrustment, execute settlement of each valid transaction and take corresponding settlement responsibility in line with the securities trading rules; the securities transfer between the securities company’s securities settlement account and its client’s account shall be executed by the CSDCC or CCDC commissioned by the securities company after the market close. The investor and a securities company involved in a collateralized repurchase agreement shall provide the required pledged securities to the CSDCC or CCDC in accordance with the operating rules; the liabilities between the investor and the securities company will not prejudice the CSDCC’s or CCDC’s pledge rights on the pledged securities. 	<p>Bonds are transferred on T, cash on T+1.</p> <p>Finality of trade is not so much the issue in the PRC bond market as the actual transfer of the entitlement takes place in the form of the owner registration, according to the Chinese legal concept underlying all legislation; hence, finality of trade is not an important concept, like in mature markets.</p> <p>Final and irrevocable on T+1.</p>

continued on next page

Table 12. continuation

Jurisdiction	Transfer of Securities (or Property Rights)	Finality of Settlement
	<p>c. The securities company shall process the transfer of securities custody to another securities company upon the client's request, in line with relevant operating rules of the stock exchange and the CSDCC or National Association of Financial Market Institutional Investors and CCDC. (Compared to other ASEAN+3 markets, a professional custody/intermediary system is only now evolving in PRC.)</p>	
Hong Kong, China	<p>Transfers of interests in bonds: Both Bank for International Settlement (BIS) Model 1 (gross-gross) and BIS Model 3 (net-net). Transfer of title can be evidenced through registration.</p> <ol style="list-style-type: none"> 1. Transferees and transferors should send transfer instructions to the CMU for matching and settlement. The transfer of ownership becomes effective upon matching a debit instruction with the corresponding credit instruction and registration in the book entries in the securities accounts of CMU Members within the CMU Service. 2. Entitlement perfection against the third party and Finality of transactions <ol style="list-style-type: none"> a. Real-time securities transfer transactions on the CMU Members' Terminal or SWIFT16 are immediately completed upon successful debiting of funds from the buyer and debiting of securities from the seller, and are deemed final (not subject to waiting time). b. End-of-day securities transfer transactions are balanced during CMU end-of-day settlement processing. c. Notwithstanding the mode/means of transfer, all local securities transfer instructions affected through the CMU Service shall be settled by the Hong Kong Monetary Authority debiting or crediting the relevant securities accounts of the CMU Members concerned, and once debited or credited to such securities accounts; such securities transfer instructions shall be deemed made, completed, irrevocable and final. d. The situation can be more complex where the securities transfer instructions are effected through linkages with other regional central securities depositories (CSDs) including the Korea Securities Depository, AustraClear, and China Central Depository and Clearing (CCDC), or with international CSDs (ICSDs), including Clearstream or Euroclear. e. It is also worth noting that the finality of the transactions settled through the CMU system is protected from insolvency laws (including liquidators and receivers) under section 19 of the CSSO (Cap 584). For example, the securities transactions, once settled, may not be set aside on grounds of unfair preference. f. Prohibited transfers <ol style="list-style-type: none"> i. On-Exchange naked short selling of listed securities is prohibited in Hong Kong, and all CMU Members must undertake not to incur a short position in any of the CMU Instruments. Securities may only be sold at or through a recognized stock market if the seller (as principal) or his principal (himself as agent) has, or has reasonable grounds for believing that he or the principal has, a presently exercisable and unconditional right to vest the securities in the purchaser (section 170 of the Securities and Futures Ordinance [SFO]). ii. The concept of "presently exercisable and unconditional right to vest the securities in the purchaser" is interpreted with some flexibility iii. On-Exchange covered short sales (i.e., short selling orders) in "designated securities" (as designated by the HKSE pursuant to the Short Selling Regulations in the Eleventh Schedule to the Listing Rules) are permitted provided that: <ol style="list-style-type: none"> 1 the seller (whether acting as principal or agent) must, at the time of placing a short selling order, identify it as a short selling order and provide documentary assurance that the sale is "covered" and 2 an intermediary who receives a short selling order must ensure that he has obtained a documentary assurance that the sale is "covered". iv. The maximum penalties for contravention of section 170 of the SFO are a fine of HKD100,000 and imprisonment for 2 years. v. The Hong Kong Securities Clearing Company Limited charges a default fee of 0.50% of the market value of failed transactions. 	<p>For bonds settled on CMU, final and irrevocable upon settlement (Clearing and Settlement Systems Ordinance [CSSO]).</p> <p>For bonds settled in the Central Clearing and Settlement System, final and irrevocable upon settlement.</p>
Indonesia	<p>In general, the transfer of entitlement and ownership of scripless securities are considered completed if the related transaction status is reflected as "Settled" in the Central Securities Depository's (CSD) system. In case of receipt transaction, the holding status of the scripless securities in the securities account maintained in the CSD is reflected as "Available". The third-</p>	<p>The exchange of cash and securities is final when a settlement can no longer be unwound.</p>

continued on next page

Table 12. continuation

Jurisdiction	Transfer of Securities (or Property Rights)	Finality of Settlement
	<p>party entitlement will be ensured by showing the holding position in the accounts maintained with the CSD or in the holding confirmation issued by CSD.</p> <p>a. Indonesian Central Securities Depository (KSEI) for Scrippless, Debt Securities and <i>Sukuk</i> For scrippless shares, debt securities and <i>Sukuk</i>, KSEI maintains the records of investors' assets in an electronic book-entry system, as a domestic CSD.</p> <p>Securities transferred to the depository system are automatically registered without any additional documentation. In the books of the issuers, the securities remain registered in the names of the account holders maintained in the depository. The issuers receive regular update on the bondholders' list from KSEI for their scrippless securities while maintaining the administration of physical securities, which are registered under the name of the securities holders.</p> <p>b. Bank Indonesia (BI) for Scrippless Government Bonds and Certificate of Bank Indonesia (SBI)</p> <p>BI, as the central registry for government bonds and SBI, maintains an electronic registration of the sub-registry's positions; each sub-registry in turn maintains the account details of each beneficial owner. SBI is normally settled on T+1. For government bonds, the settlement cycle in the secondary market is T+2 or as agreed between parties involved. Settlement of government bonds and SBI is through Bank Indonesia- Scrippless Securities Settlement System, a system to facilitate online settlement transactions between the sub-registries.</p>	<p>The finality of settlement is stipulated in Exchange Rule No. II.F.3.5. Final and irrevocable on T+3.</p> <p>Finality eliminates the main legal risks of payment and settlement systems, reduces systemic risk, and ensures the smooth operation of a system.</p>
Japan	<p>Japanese Government Bonds at the Bank of Japan and corporate bonds at the Japan Securities Depository Center (JASDEC) adopt BIS Model 1 Delivery versus Payment (DVP) (gross-gross): BIS Model 1—Systems that settle transfer instructions for both securities and funds on a trade-by-trade (gross) basis, with final (unconditional) transfer of securities from the seller to the buyer (delivery) occurring at the same time as final transfer of funds from the buyer to the seller (payment).</p> <p>Legal Definition of Debt Instruments:</p> <p>1. Uniform Legal Framework for All Types of Securities</p> <p>a. The Law Concerning Book-Entry Transfer of Corporate Bonds, Stocks, and Other Securities provides the legal basis for the book-entry transfer system and dematerialization of all securities.</p> <p>b. JASDEC performs the role of the CSD in the book-entry transfer system in securities other than government bonds. In this law, the term CSD means "Designated Book-Entry Transfer Institution." Participants in the book-entry transfer systems must observe the rules established by the book-entry transfer institution.</p> <p>2. Dematerialization versus Physical Certificates</p> <p>a. As described above, according to this law and the above system for securities to be distributed, it has realized the complete dematerialization.</p> <p>b. The <i>Companies Act</i> allows the form of physical bond certificates to be issued regardless of the book-entry transfer method. However, in this case distribution in the market cannot be expected, and it is also not allowed to be owned in tax-exempt status under the Japanese taxation system.</p> <p>3. Legal Ownership Structure of Dematerialized or Immobilized Securities</p> <p>a. In the book-entry transfer institutions, securities companies and financial institutions, etc. as "Account Management Institution" may open an account for securities transfer.</p> <p>b. In the transfer account, the balance of their own account and the overall customer account are recorded respectively.</p> <p>c. Bondholders open the transfer account with the book-entry transfer institution or account management institution. By performing an electronic transfer to an account transfer record, the securities are entitled to be owned by the bondholder.</p> <p>d. Bondholders have the property rights (or legal position) against third parties and the issuers by records in their account.</p> <p>e. Should there be an insufficient transfer-account book records in the customer's account due to the over-recording, the "duty of retirement of over-recording" is generated by account management institutions. (In the event of insufficient balance in a customer account due to over-delivery, the account management institution is required to rectify the records.)</p>	<p>Final and irrevocable upon the recording in accounts on the books of relevant parties.</p>

continued on next page

Table 12. continuation

Jurisdiction	Transfer of Securities (or Property Rights)	Finality of Settlement
Republic of Korea	<p>Over the Counter: BIS Model 1 (gross-gross). Exchange: - Government Bonds: modified BIS Model 1a - Others: BIS Model 3 (net-net)</p> <p>Ownership Transfer Mechanism 1. Dematerialized securities: Delivered by book entry across the accounts of the transferor and transferee opened at the CSD or account management institution. 2. Immobilized securities: Same as dematerialized securities</p> <p>Securities deposit is a process through which rights over securities are transferred, altered, and nullified by book entry without the actual movement of physical certificates. To benefit from the securities deposit system, participants such as brokers or institutional investors have to open participant accounts at the CSDs and deposit their securities at the CSDs. In Republic of Korea, the Korea Securities Depository (KSD) is the single CSD and provides securities deposit service. The securities deposit system consists of KSD as an operator, participants and their customers as users, and deposit-eligible securities as objects. Securities holdings of participants are held in custody on a fungible basis at KSD and are settled on a book-entry basis by recording debit-credit on the account book, a legal ledger kept by KSD and its participants.</p>	<p>Final and irrevocable upon transfer, except counterparty's agreement. No exceptions for the Exchange-traded market settlement. Settlement data are transferred from Korea Exchange to KSD directly through network clearing facilities for exchange market.</p>
Malaysia	<p>In Malaysia, nearly all securities are scripless, with securities transferred electronically via Bank Negara Malaysia's Real-Time Electronic Transfer of Funds and Securities system, which is operated by its wholly-owned subsidiary, Malaysian Electronic Clearing Corporation (MyClear). Transfer instructions are conducted on a trade-by-trade basis. Listed bonds: BIS Model 2: Systems that settle securities transfer instructions on a gross basis, with final transfer of securities from the seller to the buyer (delivery) occurring throughout the processing cycle, but settle funds transfer on a net basis, with final transfer of funds from the buyer to the seller (payment) occurring at the end of the processing cycle. Unlisted debt securities: BIS Model 1: Systems that settle transfer instructions for both securities and funds on a trade-by-trade (gross) basis, with final (unconditional) transfer of securities from the seller to the buyer (delivery) occurring at the same time as final transfer of funds from the buyer to the seller (payment).</p>	<p>Finality of settlement is achieved once the book-entry transaction is shown in a settled status.</p>
Philippines	<p>BIS Model 1 (gross-gross) for government securities and for scripless corporate bonds. Unlisted corporate bonds – subject to mutual agreement. Securities in the organized market are transferred in book entry form. All trade settlements occurring through the Philippine Dealing and Exchange organized market are done on a gross, trade-for-trade basis.</p>	<p>Final and irrevocable upon settlement at the Registry of Scripless Securities and/or Philippine Depository and Trust Corporation. Final and irrevocable upon issuance of physical certificates in favor of new owner.</p>
Singapore	<p>BIS Model 2 (gross - gross) - Systems that settle securities transfer instructions on a gross basis, with final transfer of securities from the seller to the buyer (delivery) occurring throughout the processing cycle, but settle funds transfer on a net basis, with final transfer of funds from the buyer to the seller (payment) occurring at the end of the processing cycle.</p>	<p>Only for settlement date trades settling via depository's enhanced DVP system.</p> <p>Government Securities: Final upon transfer of funds and securities on settlement date.</p>
Thailand	<p>Thailand Securities Depository (TSD) provides BIS Model 1 and Model 3. TSD assumes the role of central counterparty (CCP) for multilateral netting procedure that takes place before the settlement is executed. This netting arrangement is enforceable under sections 341 to 348 of the <i>Civil and Commercial Code</i> and section 102 of the <i>Bankruptcy Act B.E. 2483 (1940)</i>. However, since section 102 of the <i>Bankruptcy Act</i> allows netting of obligations only if the cause of indebtedness incurred before the date of the receivership order, the TSD may not net its obligations against the obligations of the insolvent participant which arise on that date.</p>	<p>Securities: upon settlement of a transfer made through TSD or Bank of Thailand Automated High Value Transfer Network.</p> <p>Finality of settlement: TSD rule clearly states the timing of finality and the way finality is achieved. The transfer of funds is enforced by Bank of Thailand regulations.</p>

continued on next page

Table 12. continuation

Jurisdiction	Transfer of Securities (or Property Rights)	Finality of Settlement
		<p>However, there is no explicit legal protection for settlement finality. It can be challenged by a court decision. In accordance with section 115 of the <i>Bankruptcy Act</i>, the court is empowered to reverse the debtor's transfer of assets during the three months prior to an application to adjudicate him as bankrupt and thereafter if the court finds that the debtor transfers such assets with the intention to give undue preference to a creditor, and if the official receiver is able to prove that the transfer has been made by the debtor with the intention to cause other creditors a disadvantage.</p> <p>Thus, if the court orders the receivership of a clearing house member or a settlement bank, the court may cancel the transfer of funds and securities made during that period.</p>
Viet Nam	<p>BIS Model 3 (net-net); DVP conducted simultaneously by the Vietnam Securities Depository (VSD) for securities delivery, and BIDV for cash settlement. Listed bonds: entry in the VSD. Unlisted bonds: depends upon charter and terms and conditions of the bonds, but normally the bond certificates are entered into the bond register of the issuer. Transfer of securities ownership: article 54 of Securities Law No. 70/2006/QH11:</p> <ol style="list-style-type: none"> 1. The transfer of securities ownership with respect to categories of securities registered at the Securities Depository Centre shall be undertaken via VSD; 2. The validity of the transfer of securities ownership at VSD shall be as follows: <ol style="list-style-type: none"> a. Where securities have been centrally deposited at VSD, the transfer of securities ownership shall take effect on the date of book entry in the securities depository account at VSD. b. Where the securities have not been centrally deposited at VSD, the transfer of securities ownership shall take effect on the date of recording on the securities registration book managed by VSD. <p>According to article 4 of <i>Circular 43 /2010/TT-BTC</i> dated 25 March 2010 amending <i>Decision 87/2007/QĐ-BTC</i>, the transfer of ownership of listed or registered for trading securities shall be subject to the following principles: Any securities holder intends to transfer his ownership of securities shall deposit such securities at VSD via depository members to buy or sell such securities via Stock Exchanges or transfer his ownership as prescribed in Clause b of this Article (except for any transfer of ownership due to inheritance factors or the fact that the issuer redeems it shares from employees upon employment termination). -VSD shall only execute transfers of ownership of securities outside its securities trading system if such transfers are non-commercial or fail to be executed via trading systems at Stock Exchanges. Such transfers shall include the following cases:</p> <ul style="list-style-type: none"> + Making as a present, inheriting according to the Civil Law + Odd-lot transactions according to the law of securities and securities market. + Issuers/labor unions of issuer buyback preferred shares of their employee which terminate their labor contracts to become treasury shares and bonus shares for their current employee. + Issuers use treasury shares to bonus/labor union of issuer distribute bonus shares for their employee. + Foundation shareholder transactions in restricted time. + Issuers change their strategic shareholders in restricted time. + In case if securities have registered in VSD and have accepted in principal by Exchanges but have not listed on Exchanges yet. 	3:00 p.m. on Settlement Date is assumed as effective settlement time for both cash and securities.

continued on next page

Table 12. continuation

Jurisdiction	Transfer of Securities (or Property Rights)	Finality of Settlement
	<p>+ Investors leave securities in trust for fund manager in case fund manager accepts to manage trusted investment portfolio by assets.</p> <p>Different from equity, there is no general meeting for bond holders. Bond is debt instrument so that the rights of bond holder are stipulated according to Decree 01/2011/ND-CP:</p> <p>+ Bondholder are guaranteed for in-time and sufficient settlement of interest and principal.</p> <p>+ Bondholder has entitlement to transfer, give, make as a present, inherit, discount, and pledge in credit relationship and civil relationship according to current law.</p> <p>As for guarantee for bond settlement,</p> <p>+ As for corporate bond which guaranteed by government (according to Decree 01/2011/ND-CP): the government commits to protect bondholders' interests.</p> <p>+ As for guaranteed corporate bonds (according to Clause 44 of Decree 52/2006/ND-CP): if the issuer fails in interest and principal settlement, the guaranteed asset will be liquidated to refund the due debt. In case other credit organizations act as settlement guarantor, they have responsibilities to refund the debt to bondholder.</p> <p>Currently, there is no specified company system to guarantee for corporate bond settlement in Viet Nam.</p>	

^a Modified BIS Model 1: Netting bonds per issue and netting payments per issue.

^b 1) The account structure of dematerialized and immobilized securities is explained based on the two-tier account structure. 2) The form of ownership for dematerialized securities cites the common view in the academia of Japan, and the form of ownership for immobilized securities is explained in terms of the Korean deposit and settlement system.

Source: ADB Consultants, based on research materials and market visit information

XIII. Legal Basis and Definition of “Settlement and Clearing”

Table 13. Legal Basis and Definition of “Settlement and Clearing”

Jurisdiction	Form of the Bonds (Settlement Method)	Definition of “Settlement and Clearing”
People's Republic of China	<ul style="list-style-type: none"> Book entry 	<p>After a trade has been matched by a trading system, it needs to be cleared and settled so that the seller gets paid and the buyer gets ownership of the security traded.</p> <p>1. Clearing Clearing involves all steps in post-trade processes apart from the final settlement, i.e., apart from the final payment and change in ownership.</p> <p>2. Settlement Settlement is the last step in the post-trade process. Settlement may be:</p> <ol style="list-style-type: none"> Net: obligations between participants are set-off against each other, or, Gross: each transaction is settled individually, and may be: real-time: transactions are settled as and when trades are agreed with no delay, or occur at regular intervals, usually on a rolling schedule at a specific time, or at the end of a day', since the China Securities Depository and Clearing Corporation sets a specific time within the business day (when cash payments are to be effected by).
Hong Kong, China	<ul style="list-style-type: none"> Book-entry form (dematerialized) for Exchange Fund papers, and Global note form for corporate bonds 	<p>The clearing and settlement system in the Clearing and Settlement System Ordinance means a system established for:</p> <ol style="list-style-type: none"> the clearing or settlement of payment obligations; or the clearing or settlement of obligations for the transfer of book-entry securities, or the transfer of such securities
Indonesia	<ul style="list-style-type: none"> Book entry (from 2000) Physical certificate still exists (issued prior to 2000) 	<ul style="list-style-type: none"> The definition of clearing in Bapepam-LK regulation No.III.A.10 on securities transactions is as follows: “Clearing is a process of determining the rights and obligations that arise from Exchange transactions.” <p>While the definition of settlement as referred in the Indonesian Central Securities Depository regulation on central depository services (chapter 8), “Securities transaction settlement services are part of Central Depository services provided for the fulfillment of rights and obligations as the results of Stock Exchange Transactions or Over-the-Counter Transactions conducted by means of book-entry of Securities and/or funds between Securities accounts.”</p>

continued on next page

Table 13. continuation

Jurisdiction	Form of the Bonds (Settlement Method)	Definition of “Settlement and Clearing”
Japan	<ul style="list-style-type: none"> Book entry (Dematerialized) 	<p>A securities clearing and settlement system is defined as follows:</p> <ol style="list-style-type: none"> 1. A Book-Entry Transfer Institution as defined by article 2, paragraph 2 of the <i>Act on Transfer of Bonds, Shares, etc.</i>, 2. A Financial Instruments Clearing Institution as defined by article 2, paragraph 29 of the Financial Instruments and Exchange Act, or the so-called central counterparty (CCP) clearing agency. <p>The Japan Government Bond Clearing Corporation is operating in the Japanese government bond market.</p> <p>On the other hand, the clearing institution for corporate bonds does not exist in Japan.</p>
Republic of Korea	<ul style="list-style-type: none"> Book entry 	<p>“Clearing” is a series of processes that a CCP performs to guarantee the settlement by netting the credits and liabilities between the sellers and the buyers and to instruct the settlement agency to settle.</p> <p>“Settlement” is the completion of a transaction, wherein the seller transfers securities or financial instruments to the buyer, and the buyer transfers money to the seller. It is classified into delivery versus payment (DVP) and free of payment (FOP) depending on connection or separation of delivery and payment.</p> <p>The Korea Exchange provides clearing services as a CCP for the stock market and also provides clearing and settlement services for the derivatives market. Meanwhile, the Korea Securities Depository provides settlement services for stock market and provides clearing services as well as settlement services for the over-the-counter market.</p>
Malaysia	<ul style="list-style-type: none"> Listed bonds: Book entry at Bursa Malaysia Depository Unlisted debt securities: Book entry at Bank Negara Malaysia (BNM) 	<p>Definition of Clearing and Settlement:</p> <ol style="list-style-type: none"> 1. Clearing <ol style="list-style-type: none"> (a) “Clearing” means the process of exchanging and reconciling payment items that result in the establishment of final positions for Settlement. (b) “Clearing facilities” mean a facility for the clearing or settlement of transactions in securities traded on a stock exchange or futures contracts traded on a futures market; a facility for the guarantee of settlement of transactions; or such other clearing or settlement facility or class of clearing or settlement facilities as the Commission with the approval of the Minister may allow. (c) “Clearing house” means a person whose activities or objects include the provision of clearing facilities. (d) The clearing house is the Bursa Malaysia Securities Clearing. 2. Settlement <p>Based on provisions in the Capital Market and Services Act 2007, settlement, in relation to a market contract, means the discharge of the rights and liabilities of the parties to the market contract whether by performance, compromise or otherwise; and includes partial settlement effected in accordance with the rules of an approved clearing house.</p> <ol style="list-style-type: none"> (a) All securities trades are generally settled based on a DVP basis. For all government securities and scripless corporate debt securities, ownership and transfers are reflected as book entries in the custody accounts with BNM in Real Time Electronic Transfer of Funds and Securities (RENTAS). (b) The settlement of the primary and secondary market transactions in government securities and unlisted corporate debt securities take place through the Scripless Securities Trading System, which is part of the RENTAS system. (c) US dollar-denominated debt securities and Sukuk will be settled in RENTAS on a DVP basis while those denominated in other foreign currencies may be settled on a non-DVP basis. (d) Scripless securities, including Malaysian government securities and selected debt securities and Sukuk, can also be settled internationally via major global custodian banks and international central securities depositories, such as Euroclear and Clearstream.
Philippines	<ul style="list-style-type: none"> Government Securities: Book entry in the Registry of Scripless Securities or in the Philippine Depository and Trust Corporation (PDTC) Scripless Corporate Bonds: Book entry in PDTC 	<ul style="list-style-type: none"> • <i>Republic Act No. 8799 or the Securities Regulation Code</i> Chapter I, Title and Definitions, SEC. 3. Definition of Terms. “Clearing Agency” is any person who acts as intermediary in making deliveries upon payment to effect settlement in securities transactions. • Revised Implementing Rules and Regulations of the <i>Securities Regulation Code Rule 3</i> Definition of Terms C. Clearing agency is any entity that provides a facility to a broker dealer, salesman, or associated person of a broker dealer or another clearing agency for the performance of any of the following activities:

continued on next page

Table 13. continuation

Jurisdiction	Form of the Bonds (Settlement Method)	Definition of “Settlement and Clearing”
	<ul style="list-style-type: none"> Physical Corporate Bonds: Endorsement and actual delivery of physical certificates with duly notarized Deed of Assignment 	<ul style="list-style-type: none"> (i) make deliveries in connection with transactions in securities; (ii) reduce the number of settlements of securities transactions or allocate settlement responsibilities in accordance with the rules issued by the Commission or the Exchange; and (iii) provide the means for the central handling of securities so that transfers, loans, pledges and similar transactions can be made by bookkeeping entry; or otherwise facilitate the settlement of securities transactions without physical delivery of securities certificates.
Singapore	<ul style="list-style-type: none"> Book-entry for government bonds Central Depository (Pte.) holds universal or global certificates for immobilized bonds 	<p><i>Securities and Futures Act</i> (SFA) introduces a definition for “clearing or settlement,” which covers any of the activities comprising post-trade matching and confirmation, clearance and settlement.</p> <ul style="list-style-type: none"> SFA Part III: Clearing Facilities <p>Objectives of this Part 47. The objectives of this Part are —</p> <ul style="list-style-type: none"> (a) to promote the safety and efficiency of clearing facilities that support systemically important markets or form an integral part of the financial infrastructure; and (b) to reduce systemic risk. <p>Interpretation of this Part 48. (1) In this Part, unless the context otherwise requires — “settlement” in relation to a market contract, includes partial settlement.</p> <p>“market contract” means —</p> <ul style="list-style-type: none"> (a) a contract subject to the business rules of a designated clearing house that is entered into between the designated clearing house and a participant pursuant to a novation (however described), whether before or after default proceedings have commenced, which is in accordance with those business rules and for the purposes of the clearing or settlement of transactions using the clearing facility of the designated clearing house; or (b) a transaction which is being cleared or settled using the clearing facility of a designated clearing house and in accordance with the business rules of the designated clearing house, whether or not a novation referred to in paragraph (a) is to take place. <p>General obligations 59. (1) A designated clearing house shall</p> <ul style="list-style-type: none"> (a) as far as is reasonably practicable, operate a safe and efficient clearing facility; (b) manage any risks associated with its business and operations prudently; (c) in discharging its obligations under this Act, not act contrary to the interests of the public, having particular regard to the interests of the investing public; (d) ensure that access for participation in its clearing facility is subject to criteria that are fair and objective, and that are designed to ensure the safe and efficient functioning of its facility and to protect the interests of the investing public; (e) maintain business rules that make satisfactory provision for <ul style="list-style-type: none"> (i) the clearing facility to be operated in a safe and efficient manner; and (ii) the proper regulation and supervision of its members; (f) enforce compliance by its members with its business rules; (g) have sufficient financial, human and system resources — <ul style="list-style-type: none"> (i) to operate a safe and efficient clearing facility; (ii) to meet contingencies or disasters; and (iii) to provide adequate security arrangements; and (h) ensure that it appoints or employs fit and proper persons as its chairman, chief executive officer, directors and key management officers.
Thailand	<ul style="list-style-type: none"> Book entry 	<p>According to the Thailand Clearing House Rules and Regulations, “securities clearing and settlement” mean the payment, acceptance of payment, delivery, and taking delivery of, securities.</p> <p>According to Detailed Assessment of Observance of Thailand Securities Depositories of the Committee of Payment and Settlement Systems -International Organization of Securities Commission Recommendations for Securities Settlement Systems in April 2008:</p> <p>1. Legal basis of the clearing and settlement</p> <p>The securities clearing and settlement activities in Thailand are governed and regulated by specifically issued laws and regulations and by provisions in other legislations and regulations. The main laws and regulations are:</p> <ul style="list-style-type: none"> a. The <i>Civil and Commercial Code</i>: (e.g., provisions governing juristic acts, obligations, contracts); b. The <i>Securities and Exchange Act B.E. 2535 (1992) (SEA)</i> (sections 50–55,199, 224–228); c. The <i>Public Limited Company Act B.E. 2535 (1992)</i>; d. The notifications, rules, and regulations issued by the Stock Exchange of Thailand, and the Thailand Securities Depository (TSD);

continued on next page

Table 13. continuation

Jurisdiction	Form of the Bonds (Settlement Method)	Definition of “Settlement and Clearing”
		<p>e. The agreement between members and the TSD as a central securities depository and a clearinghouse;</p> <p>f. <i>Bank of Thailand Automated High Value Transfer Network Rules and Regulations B.E. 2549</i> (2006); and</p> <p>g. <i>The Bankruptcy Act B.E. 2483</i> (1940).</p>
Viet Nam	<ul style="list-style-type: none"> Book entry 	<p>1. Securities Clearing According to Item 7 and Item 8 of article 2 - Decision No. 87/2007/QDBTC on registration, depository, clearing and settlement of securities, securities' clearing includes bilateral clearing and multilateral clearing.</p> <p>- Bilateral clearing means the method of clearing securities transactions which have been matched during the same day between any two trading parties with respect to the one type of securities, in order to determine the net sum and securities which must be settled by both parties.</p> <p>- Multilateral clearing means the method of clearing securities transactions which have been matched during the same day between all trading parties with respect to the one type of securities, in order to determine the net sum and securities which must be settled by both parties.</p> <p>The Vietnam Securities Depository (VSD) clears settlement obligations (the receivables and the payables) towards transactions of listed stocks, fund certificates, corporate bonds having the same payment time and manner at two Stock Exchanges with a view to calculating settlement obligations to receive or to pay through each depository member</p> <p>2. Securities Settlement According to article 32 of <i>Decision No. 87/2007/QD-BTC</i>, VSD settles securities based on bilateral and multilateral clearing results, and then settles each transaction of listed and unlisted securities. Securities delivery is made by VSD, cash payment is made by the settlement bank, and the DVP principle is to be observed.</p> <p>Article 3 of VSD guideline on securities clearing and settlement: VSD shall clear securities, funds and settle securities transactions in accordance with the principles prescribed in articles 32 and 33 of the “Guidelines on Securities Registration, Depository, Clearing and Settlement” issued with <i>Decision No. 87/2007/QDBTC</i> dated 22 October 2007 by the Minister of Finance and article 11 of <i>Circular No. 43/2010/TT-BTC</i> dated 25 March 2010 by the Minister of Finance on amending and supplementing the Guidelines on Securities Registration, Depository, Clearing and Settlement issued with <i>Decision No. 87/2007/QD-BTC</i> dated October 22, 2007 by the Minister of Finance.</p>

Source: ADB Consultants, based on research materials and market visit information.

XIV. Registration and Issuing Approval Procedures of Bonds

Table 14. Registration and Issuing Approval Procedures of Bonds

Jurisdiction	Registration and Issuing Approval Procedure			
People's Republic of China (PRC)	Market	Inter-bank Bond Market (Over the Counter, OTC)	Commercial bank counter market (OTC)	Exchange bond market (Shanghai Stock Exchange and Shenzhen Stock Exchange)
	MAIN REGULATOR	People's Bank of China (PBOC)	PBOC	China Securities Regulatory Commission (CSRC)
	<p>There is no universal approval procedure for bond issues in PRC. For different types of bonds, there are different issue examination and approval authorities (some bonds go through registration and recording system).</p>			
	Bond classes	Issue examining and approval authority	Related regulations	
	Treasury Bonds	National People's Congress Standing Committee (balance control)	<p><i>Law of the People's Republic of China on Supervision by the Standing Committees of the People's Congresses at all Levels</i></p> <p><i>Regulations of the Treasury Bills of the People's Republic of China</i></p>	

continued on next page

Table 14. continuation

Jurisdiction	Registration and Issuing Approval Procedure		
	Bond classes	Issue examining and approval authority	Related regulations
	Central Bank Bills	PBOC	<i>Law of the People's Republic of China on the People's Bank of China</i>
	Policy Financial Bonds (Policy Bank Bonds)	PBOC, China Banking Regulatory Commission (CBRC)	<i>Administrative Rules for the Issuance of Financial Bonds in the National Inter-bank Bond Market</i>
	Commercial Bank Bonds		"Several Issues Regarding the Issuance of Hybrid Capital Notes by Commercial Banks"
	Special Financial Bonds		"Notice on the Issuance of Financial Bonds by Financial Leasing Companies and Auto Financing Companies"
	Non-bank Financial Institution Bonds		<i>The Rules on the Issuance of Subordinated Bonds By Commercial Banks</i>
	Securities Company Bonds	CSRC	<i>Interim Measures for the Administration of Bonds of Securities Companies</i>
	Securities Company Commercial Paper	PBOC, CSRC	<i>Securities Company Short-term Financing Notes Regulations</i>
	Enterprise Bonds State-Owned Enterprises Bonds	National Development and Reform Commission (NDRC)	<i>Enterprise Bond Management Ordinance</i> "On March 19, 2007 Notice of problems related to the first corporate bond issue size and examination approval in 2007"
	Commercial Paper, Medium-term Notes	PBOC authorized the National Association of Financial Market Institutional Investors to manage registration	"On January 2, 2008 promotion of the development of corporate bond market and simplification of procedures of issue examination" <i>Measures on the Administration of Non-Financial Corporate Debt-Financing Instruments at the inter-bank Bond Market</i> "Inter-bank Bond Market, non-financial corporate debt financing instruments disclosure rules"
	Asset-backed Securities	CBRC, PBOC	"Administration of Pilot Projects for Securitization of Credit Assets Procedures"
	Listed Corporate Bonds	CSRC	<i>Interim Regulations on Administration of Corporate Bonds</i>
	International Agency Bonds	PBOC, Ministry of Finance, NDRC, CSRC	<i>Provisional Administrative Rules on International Development Institutions' Issuance of RMB Bonds</i>
	Convertible Bonds	CSRC	<i>Interim Measures for the Administration of Convertible Bonds</i> "Issue of Convertible Bonds By Listed Companies Implementing Procedures"
	Issuer in the Inter-bank Bond Market	PBOC	"National Inter-bank Bond Market trading circulation audit rules"
Hong Kong, China	Regulations and rules on issuing debt instruments: <ol style="list-style-type: none"> For bonds to be listed on the Stock Exchange of Hong Kong (SEHK), bond issuers should observe, among others, the Listing Rules which set out the qualifications for listing, application procedures and requirements, listing documents and arrangements etc. Issuers of bonds to be listed on the SEHK should also observe the Trading Rules promulgated by the Hong Kong Exchange and Clearing should be observed. For bonds to be listed on the HKSE, issuers should also observe the requirements of the Listing Rules, as well as Parts II and XII of the CO including section 44B. 		

continued on next page

Table 14. continuation

Jurisdiction	Registration and Issuing Approval Procedure
	<p>4. Save for the above and the specific laws mentioned above bonds issued by different types of entities, there are in general no other regulations governing the issuance of listed or non-listed bonds in Hong Kong, i.e.,</p> <ol style="list-style-type: none"> a. Both domestic and foreign entities are eligible to issue debt instruments in Hong Kong. b. Foreign entities interested in raising funds in Hong Kong should however ascertain whether it is permitted under the law of their jurisdictions. c. If the debt instruments are to be listed on the SEHK, issuers have to comply with the requirements for reporting and disclosure of information, etc. as set out in the Listing Rules and other relevant documents of the SEHK.
Indonesia	<p>A Registration Statement becomes effective within 45 days from the date of receipt by Bapepam-LK completely, or from the date of final amendment delivered by the issuer or requested by Bapepam-LK.</p> <p>There is a rule related to Sustainable Public Offering (Shelf Registration) based on <i>Peraturan Bapepam dan LK Nomor IX.A.15: Penawaran Umum Berkelanjutan</i>, which allows the debit security or bond (<i>efek bersifat utang</i>, EBU) issued to the public in several stages. An issuer has to submit a Registration Statement to provide a Sustainable Public Offering with the following requirements: Under <i>Peraturan Bapepam dan LK Nomor IX.A.11: Penawaran Umum Efek Bersifat Utang Dalam Denominasi Mata Uang Selain Mata Uang Rupiah</i>, the initial public offering (IPO) of EBU denominated in currencies other than rupiah has to be in accordance with Bapepam-LK rules related to IPO. Additional information shall be disclosed in the prospectus.</p>
Japan	<p>Registration and Issuance Procedure of Public Offering Bonds and Notes:</p> <p>In order to make the information contained in the Securities Registration Statement (SRS) and its attachments accessible to general investors, the <i>Financial Instruments and Exchange Act (FIEA)</i> requires the SRS and its attachments to be filed by the issuer with the Director-General of the Kanto Local Finance Bureau or the relevant Local Finance Bureau (sometimes called “FB”), and for such filings to remain open for public inspection during a period of 5 years.</p> <p>In addition, the issuer must keep such documents at its head office and principal branch offices and make them available for public inspection.</p> <p>Once the SRS is filed with the relevant Finance Bureau, solicitation may be made; but before the securities are acquired by investors, the registration must have become effective. The registration becomes effective generally when 15 days have elapsed from and excluding the day of filing (“waiting period”).</p> <p>The relevant Finance Bureau may designate a shorter period or may notify the issuer that the registration will become effective immediately or will become effective on or after the day of filing if the relevant Finance Bureau concludes that the public can easily understand the contents of the filed registration documents or the information on the issuer has been widely disseminated to the public.</p> <p>In many cases, if the issuer is already filing continuous disclosure documents, the waiting period is shortened to seven days.</p> <p>If, prior to the effective date of the registration there occurs any change with respect to any material fact which should be stated in the SRS, or if there arises any situation prescribed by a relevant Cabinet Ordinance calling for the modification of the contents of the registration documents, the registrant should file an amendment to the SRS.</p> <p>The relevant Finance Bureau may, but is not obliged to, issue an order for filing an amendment to the SRS if it finds the registration documents defective or insufficient with respect to any material facts stated therein.</p> <p>Once an amendment to the SRS is filed, the aforementioned waiting period starts, on or several days after the day of filing of such amendment to the SRS, depending upon the nature of the amendment.</p> <p>The SRS is generally comprised of three sections: Information Concerning Securities, Information Concerning Issuer, Information Concerning Guarantor and Special Information.</p> <p>In addition, for the SRS for foreign Specified Securities referred to in section 2.03[3] below, the “Information Concerning the Legal System of the Home Country of the Issuer, etc.” must also be disclosed.</p> <p>In the securities markets, in addition to the disclosure requirements, there are regulations concerning securities transactions under the FIEA designed to ensure fair trade.</p> <p>Following are the methods of filing the SRS.</p> <ol style="list-style-type: none"> 1. Complete Disclosure Method <p>The SRS must be filed by the issuer with the Director-General of the relevant Finance Bureau before the commencement of a public offering.</p> <ol style="list-style-type: none"> 2. Attachment Method <p>Companies that filed annual securities reports for the previous year may attach annual securities reports, semi-annual securities reports or quarterly securities reports and their amendments to the SRS in order to avoid duplicate filing.</p> <ol style="list-style-type: none"> 3. Reference Method <p>Companies that satisfy the requirements for (2) above, list their shares on the Stock Exchanges or OTC markets and also satisfy additional requirements under a Cabinet Ordinance may make reference in the SRS to the documents identified in (2) and extraordinary reports rather than attaching the entire documents.</p> <ol style="list-style-type: none"> 4. Shelf Registration Method <p>Frequent issuers that qualify to use the Reference Method can also use the Shelf Registration Method in order to render their issue more cost-efficient and timely.</p>

continued on next page

Table 14. continuation

Jurisdiction	Registration and Issuing Approval Procedure
	<p>Any issuer who satisfies the requirements for registration by the Reference Method referred to above may register proposed offering(s) by filing with the relevant Finance Bureau a “shelf registration statement” setting out the period during which the securities are intended to be offered, the kind of securities, the proposed total amount of offering and the anticipated principal underwriters, in accordance with a Cabinet Ordinance.</p> <p>The shelf registration becomes effective after a shorter period (usually, 7 days) than the period in the case of filing the SRS. Once the shelf registration becomes effective, no individual SRS need be filed for the offering of any part of the securities covered by the shelf registration but the registrant should file with the relevant Finance Bureau a “supplement to the shelf registration statement” setting out the amount of offering and other terms of the offering.</p> <p>The shelf registration ceases to be effective upon the expiry of the intended period thereof.</p> <p>If, prior to such expiry, the offerings of the total amount registered have been completed, the registrant should file a “shelf registration withdrawal statement” with the relevant Finance Bureau.</p> <p>If, during the effective period of shelf registration, a certain situation arises as prescribed by the FIEA and Cabinet Ordinance, the registrant should file an “amendment shelf registration statement.”</p> <p>No such amendment can be made to increase the total amount of offerings, change the proposed period of offerings, or change the kind of securities subject to the registration.</p> <p>Special provisions are made with respect to the shelf registration method for commercial papers.</p> <p>TOKYO PRO-BOND Market Listing:</p> <p>A. Initial Listing Application for the listing of bonds on the TOKYO PRO-BOND Market:</p> <ol style="list-style-type: none"> a. The listing of bonds on the TOKYO PRO-BOND Market is carried out through an application by issuers. b. The Initial Listing Applicant is required to submit an Initial Listing Application and Initial Listing Application Documents to the Exchange for listing. <ol style="list-style-type: none"> i. The Initial Listing Applicant may consult or make inquiries to the Exchange prior to listing regarding the Initial Listing Application. ii. The Initial Listing Applicant shall state in the Initial Listing Application Documents that there are no false statements in the Documents. c. The Initial Listing Applicant is required to publish Specified Securities Information (specified securities information prescribed in article 27 to 31 of the FIEA) at the time of filing an application of a listing of bonds. <ol style="list-style-type: none"> i. Specified Securities Information is required to be prepared based on the format stipulated by the Exchange or other formats approved by the Exchange as appropriate. For example, the disclosure formats utilized in the euro market may be approved to be used. Besides, the language of disclosure of Specified Securities Information is required to either be in Japanese or in English, or in both languages. Foreign issuers do not have to translate their English documents into Japanese. ii. Parties seeking to apply for a bond listing can register the maximum aggregate amount of bonds issued in a program by publishing the “Program Information” pursuant to the rules established the Exchange. Specifically, information on the maximum limit of the outstanding balance and other information shall be described in the Program Information, validity period of which is 1 year (equivalent to Euro medium-term note program). In the case where an issuer publishes the Program Information, such issuer is allowed to prepare the Specified Securities Information only with the remaining information. In the case where the issuer publishes the adequate Specified Securities Information after the registration of Program Information, the listing will be accepted by the Exchange following the submission of an Initial Listing Application and Initial Listing Application Documents including the Specified Securities Information. iii. Under the FIEA, if the Initial Listing Applicant is a continuous disclosure company (a company which is obliged to submit the Annual Securities Report annually), publishing Issuer Filing Information (see 3 b (ii) below for details) is not required. Also, under the rules established by the Exchange, that the disclosure company can omit the corporate information from description in Specified Securities Information, provided that such Specified Securities Information contains a notice that the company submits the Annual Securities Report. <p>B. Qualification Requirements for Initial Listing Companies:</p> <p>The Initial Listing Applicant must satisfy all of the requirements listed below when listing bonds on the TOKYO PRO-BOND Market:</p> <ol style="list-style-type: none"> a. The said bonds obtain a credit rating from a credit rating agency (meaning registered credit rating agencies stipulated in article 2, paragraph 36 of the FIEA and rating agencies established under foreign laws that are subject to frameworks of regulations and supervision equivalent to those of registered credit rating agencies.). A credit rating for the above-mentioned Program Information may be used as the credit rating. b. The securities company that serves as Managing Underwriter for bonds to be listed on the Exchange is required to be registered on the Exchange’s Managing Underwriter List. <ol style="list-style-type: none"> i. Any securities company that wishes to register to appear on the Managing Underwriter List can apply to do so with the Exchange. The Exchange will then decide whether to approve the registration based on consideration of the company’s track record in corporate bonds underwriting, etc. The Exchange will also assess the ongoing eligibility of securities companies to be included on the Managing Underwriter List.

continued on next page

Table 14. continuation

Jurisdiction	Registration and Issuing Approval Procedure
	<p>ii. The requirements for companies registered on the Managing Underwriter List will be different to those for J-Nomads in that they will have no duties to the Exchange in respect of the Qualification Requirements for Initial Listing Companies and no post-listing duties.</p> <p>C. Approval of Listing: Once it has confirmed that the Initial Listing Applicant satisfies the Requirements for Initial Listing, the Exchange approves the listing of the bonds and publicly announces it in a timely fashion.</p>
Republic of Korea	<p>Regulations and Rules and Procedures on Issuing Debt Instruments</p> <p>1. Disclosure requirements Article 123 (Preparation and Disclosure of Investment Prospectus), Financial Investment Services and Capital Markets Act (FSCMA): When an issuer publicly offers or sells securities in accordance with article 119, the issuer shall file an investment prospectus (hereinafter referred to as “investment prospectus”), prepared in accordance with the manner prescribed by Presidential Decree, with the Financial Services Commission (FSC) on the day on which the relevant registration statement becomes effective (or the day on which the supplements to a universal shelf registration statement are filed, in cases where the supplements to the universal shelf registration statement shall be filed in accordance with article 119[2]) and keep it at a place specified by Ordinance of the Prime Minister to make it available to the public for inspection. <Amended by Act No. 8863, Feb. 29, 2008></p> <p>No investment prospectus shall contain any description different from the one described in the relevant registration statement (including any supplements to a universal shelf registration statement under Article 119(2); hereafter the same shall apply in this Chapter) or omit any description stated therein: Provided, that a description of the balance between confidentiality in corporate management, etc. and protection of investors, etc., as prescribed further by Presidential Decree. An issuer of the collective investment securities specified by Presidential Decree shall file an additional investment prospectus separately from the one under paragraph (1) in accordance with the following subparagraphs, with the Financial Services Commission (FSC), and shall keep it at a place specified by Ordinance of the Prime Minister to make it available to the public for inspection: Provided, that such filing, keeping, and disclosure may be omitted, if offering or selling such collective investment securities is discounted: <Amended by Act No. 8863, Feb. 29, 2008></p> <p>A revised investment prospectus shall be filed at least once after the investment prospectus under paragraph (1) is filed within an interval prescribed by Ordinance of the Prime Minister; and In cases where an amendment to registration is filed in accordance with Article 182 (8), an investment prospectus in which such amendment is reflected shall be filed within five days after a notice of amended registration is delivered. [FSCMA, Chapter I in Part III]</p> <p>2. Credit Rating requirements Regulation 11. Underwriting of Non-Guaranteed Bonds In the case of an underwriter underwriting non - guaranteed bonds, such bonds shall be those that have been rated by at least two (one agency, in the case of underwriting ABS issued in the form of bonds pursuant to the Act on ABS or in inevitable cases such as the business suspension of credit rating agencies) credit rating agencies from among those approved for the credit ratings business pursuant to the provisions of the Act on Use and Protection of Credit Information. However, non-guaranteed bonds issued by foreign corporations, etc., shall be deemed as those rated in accordance with this provision if they are rated by two or more credit rating agencies (referring to international credit rating agencies as prescribed by the Governor of the Financial Services Commission (FSC) in Item e of [§2 - 11 (2)1] of the FSC’s Regulations on Securities Issuance and Disclosure; the same hereinafter in this chapter). [Chapter III in Regulations on Securities Underwriting Business]</p> <p>3. Minimum lead time (number of business days) for registration approval Article 120 (Effective Date of Registration Statement, etc.) The registration of securities under Article 119(1) and (2) (hereinafter referred to as “securities registration”) shall be effective on the day after the expiration of the time period prescribed by Ordinance of the Prime Minister, considering the type of securities or the characteristics of the transaction, etc., which shall begin on the day on which the registration statement is submitted and accepted by the Financial Services Commission. <Amended by Act No. 8863, Feb. 29, 2008></p> <p>The Financial Services Commission (FSC) shall not refuse to approve a registration statement, unless it is not prepared in conformity with the prescribed form of the registration statement, there is any false description or representation in the registration statement concerning a material fact, or any description or representation of a material fact is omitted. <Amended by Act No. 8863, Feb. 29, 2008></p> <p>The effectiveness under paragraph (1) shall not include any effect of acknowledging that the descriptions of the relevant registration statement are true or correct, or the Government’s assurance or approval of the value of the securities.</p>

continued on next page

Table 14. continuation

Jurisdiction	Registration and Issuing Approval Procedure
	<p>An issuer of securities shall, when it intends to withdraw its securities registration, file a withdrawal statement with the Financial Service Commission (FSC) no later than the day before the date set for offering to acquire or purchase the securities stated in the relevant registration statement. <Amended by Act No. 8863, Feb. 29, 2008> [FSCMA, Chapter I in Part III]</p> <p>4. Availability of Shelf Registration and Associated Documentation Requirements If bond issuer uses the shelf registration, bond issuer must submit the “universal shelf registration statement” to the FSC. The legal provision for shelf registration is stipulated at Article 119(2) in FSCMA. Article 119 (Registration of Public Offering and Sale) When a registration statement for a total amount of securities to be publicly offered en bloc over a certain period of time (hereinafter referred to as “universal shelf registration statement”) in accordance with the guidelines and methods prescribed by Presidential Decree, considering the type of securities, scheduled issue period, frequency of issuance, requirements for the issuer, etc., is submitted to and accepted accordingly by the Financial Services Commission (FSC), such securities may be publicly offered or sold without necessarily submitting a registration statement each time such securities are publicly offered or sold during the period of time stated therein, notwithstanding paragraph (1). In such cases, the documents related to the universal shelf registration statement (hereinafter referred to as “supplements to universal shelf registration statement”), as prescribed by Presidential Decree, shall be submitted each time such securities (excluding collective investment securities, specified by Presidential Decree) are publicly offered or sold. <Amended by Act No. 8863, Feb. 29, 2008> [FSCMA, Chapter I in Part III]</p> <p>5. Regulated suspension period The maximum of regulated suspension period is up to six months. The suspension period is imposed by FSS, if some financial investment institutions violate the regulation or the law in FSCMA.</p>
Malaysia	<p>Regulation of the Corporate Debt Securities and Corporate Sukuk Market: The Securities Commission (SC) administers the <i>Capital Markets and Services Act 2007</i>, which governs a substantial part of the activities in the domestic corporate debt securities and corporate <i>Sukuk</i> market. On 1 July 2000, the SC became the single regulator for the Malaysian corporate debt securities and corporate <i>Sukuk</i> market, and moved towards a full disclosure-based regulatory regime with the issuance of the Guidelines on the Offering of Private Debt Securities. This was followed by the issuance of the Guidelines on the Offering of Islamic Securities.</p> <p>Related Regulations and Rules on Issuing Debt Instruments:</p> <ol style="list-style-type: none"> 1. Bank Negara Malaysia (BNM) manages the liabilities of the government both in Malaysia and abroad. BNM is responsible for trading, registering, settlement and redemption of government securities through the automated trading and settlement system. BNM published the rules on Real Time Electronic Transfer of Funds and Securities and the Fully Automated System for Issuing/Tendering. 2. The SC oversees the issuance of private debt securities, asset-backed securities, Islamic securities, and structured products. 3. For foreign issuers, the Quick Reference for Information on Cross-Border Bond Issuance and Investment contains information on bond issuance by non-residents in Malaysia. 4. Under BNM’s Foreign Exchange Administration Policies, proceeds of bond issuances are not to be used for refinancing of offshore borrowing and/or financing of investments abroad exceeding MYR10 million in aggregate in a calendar year.
Philippines	<p>Regulation of the Philippine Securities Markets: Approximate Legislative Framework The Securities and Exchange Commission (SEC) regulates both primary and secondary debt markets and oversees the Philippine Stock Exchange, the three subsidiaries of the Philippine Dealing Systems Holdings Corporation, brokers, registrars, transfer agents, and clearinghouses.</p> <p>Related Regulations and Rules Disclosure Requirements Debt securities may not be offered for sale to the public, unless they are registered in accordance with sections 8 and 12 of the <i>Securities Regulation Code</i> (SRC), as implemented by SRC Rules 8.1 and 12.1, except those exempt from registration under section 9 (Exempt Securities) and section 10 (Exempt Transactions) of the SRC and SRC Rules 9.2 and 10.1. Likewise, no information relating to the offering of securities shall be disseminated unless a registration statement has been filed with the SEC, along with a preliminary prospectus of the securities intended to be sold and distributed to the public. If the securities which are the subject of the registration statement are intended to be listed in an exchange, a copy of said registration statement and all other pertinent documents shall also be filed with that exchange. The application for the listing shall also be filed with the SEC. Upon filing the registration statement, but before it is rendered effective by the SEC, the registrant may circulate a preliminary prospectus to prospective buyers of the securities. The preliminary prospectus should prominently state that the registration statement pertaining to the securities has been filed but has not yet been approved by the SEC, and that the said prospectus does not constitute an offer to sell or a solicitation of an offer to buy. Both the preliminary and final prospectus shall be worded in plain language understandable to an ordinary person.</p>

continued on next page

Table 14. continuation

Jurisdiction	Registration and Issuing Approval Procedure
	<p>The registrant should also be able to show that the prospectuses were made readily available to all those who want a copy, in sufficient copies.</p> <p>The sale of securities, which are the subject of the registration statement, shall be commenced within two (2) business days from the effective date of the registration statement and shall be continued until the end of the offering period or until sale has been terminated by action of the issuer.</p> <p>A written notice of completion or termination of the offering shall be filed with the SEC within three (3) business days therefrom, indicating the number of securities sold. If the remaining registered but unsold securities shall be offered after the completion or termination of the sale, an updated registration statement shall be filed with the SEC prior to said offering or sale.</p> <p>Commercial Papers</p> <p>The conditions for registration of commercial papers issued by corporations to the public are provided by SRC Rule 12.1, the salient points of which are as follows:</p> <p>(i) Registration statement under SEC Form 12-1 in accordance with SRC Rules 8.1 and 12.1.</p> <p>(ii) Firm commitment underwriting agreement for the commercial paper with a universal bank, investment house, or any other financial institution duly licensed under the Investment Houses Law.</p> <p>(iii) Except for issuance amounting to not more than 25% of the issuer's net worth or where there is an irrevocable committed credit line with a bank covering 100% of the proposed issuance, a commercial paper issue shall be rated by a rating agency accredited by the SEC.</p> <p>The rating requirement shall not apply to issuances amounting to not more than 25% of the issuer's net worth, or where there is an irrevocable committed credit line with a bank covering 100% of the proposed issuance.</p> <p>(iv) Payment of a filing fee, which shall be based on the total amount of commercial papers proposed to be issued and shall be subject to a diminishing fee in accordance with SEC Form 12-1.</p>
Singapore	<p>Issuing Debt Instruments related regulations/rules:</p> <p>1. Disclosure requirements</p> <p>Disclosure requirements for the issuance of debentures</p> <p>Under section 243 of the <i>Securities and Futures Act (SFA)</i>, a prospectus for an offer of securities shall contain all the information that investors and their professional advisers would reasonably require to make an informed assessment of the matters relating to the offer and the issuer.</p> <p>The <i>Securities and Futures (Offers of Investments) (Shares and Debentures) Regulations 2005 (SFR)</i> sets the specific disclosure requirements for the different types of debentures (including asset-backed securities and structured notes). The SFR also prescribes the disclosure requirements for an offer of debentures under a debenture issuance program.</p> <p>The prospectus for an offer of debentures must normally include terms of the debentures, use of proceeds, identity of directors, capitalization and indebtedness, audited financial statements and interested person transactions.</p> <p>A listed company can make an offer of debentures using an Offer Information Statement, which is a more concise disclosure document, in place of a prospectus.</p> <p>2. Debenture Issuance Program</p> <p>Under the SFA, an issuer can make multiple offers of bonds using a debenture issuance program (DIP). The prospectus for an offer of debentures that is part of a debenture issuance program shall comprise a base prospectus applicable to every offer under the DIP, and a pricing statement applicable to a particular offer. The registered base prospectus is valid for 2 years.</p> <p>3. Stop Order</p> <p>The Monetary Authority of Singapore (MAS) may, under section 242 of the SFA, serve a stop order on a person making an offer of securities that no or no further securities be allotted, issued or sold. The MAS may do so if a prospectus has been registered and:</p> <p>(a) the MAS is of the opinion that the prospectus contains a false or misleading statement;</p> <p>(b) there is an omission from the prospectus of any information that is required to be included in it;</p> <p>(c) the MAS is of the opinion that the prospectus does not comply with the requirements of the SFA; or</p> <p>(d) The MAS is of the opinion that is in the public interest to do so.</p> <p>The MAS may also serve an interim stop order on the person making the offer.</p> <p>If the interim stop order is served during a hearing, or a hearing commenced while the stop order is in force, the interim stop order will remain in force until the MAS serves a stop order. Otherwise, if there is no hearing, the interim stop order will be in force for a period of 14 days, unless it is revoked by the MAS.</p>
Thailand	<p>Securities Issuance Rules in Brief:</p> <p>1. Approval for Securities Offering</p> <p>The <i>Securities and Exchange Commission Act (SEC Act) B.E. 2535 (1992)</i></p> <p>Chapter 2 Issuance of Securities</p> <p>Division 1 Approval for the Offering of Newly Issued Securities (Sections 32-38)</p> <p>Division 2 Debentures (Sections 39-40)</p> <p>Division 3 Issuance of Secured Debentures (Sections 41-49)</p>

continued on next page

Table 14. continuation

Jurisdiction	Registration and Issuing Approval Procedure
	<p>Division 4 Register and Transferability (Sections 50-55) Division 5 Disclosure of Information and Auditor (Sections 56-62) Chapter 3 Public Offering of Securities (Sections 63-89) Division 4 Listed Securities (Sections 189-200) Chapter 6 Over-the-Counter Centre and Futures and Options Centre Division 1 Over-the-Counter Centre (Sections 204-217) Chapter 7 Institutions Related to Securities Business Division 1 Clearing House, Securities Depository Centre and Securities Registrar (Sections 219-229) The SEC Act B.E. 2535 (1992) prohibits companies from offering newly issued shares and other securities for sale without prior approval from the SEC in compliance with the rules and regulations issued by the SEC Board except for the rights offering to existing shareholders.</p> <p>This provision allows the SEC to put in place rules and regulations and consider the merits of the securities to be offered. Securities offering can be classified by types of securities as follows:</p> <ul style="list-style-type: none"> (i) Shares (ii) Derivative warrants (iii) Debt Securities (iv) Overseas Debentures (v) Warrants (vi) Securitization (vii) Securities Issuance and Offering by Foreign Issuer (viii). Foreign exchange bond (ix) <i>Sukuk</i> <p>Private placement of debt securities exempt from SEC filing for registration: Private placement of debt securities which is exempt from SEC filing for registration is defined in the following Notification. <i>Notification of the Capital Market Supervisory Board No.TorChor.9/2552 (2009)</i> Re: Application for and Approval of Offer for Sale of Newly Issued Debt Securities</p> <p>2. Disclosure of Information In offering newly issued securities for sale, companies shall apply for an approval from the SEC and disclose information to the investing public for decision making. However, the offering of existing securities by its holders can be done without SEC approval on the condition that the offerors shall disclose information prior to offering securities for sale.</p> <p>Before offering securities to the public, the offerors, who may be companies or existing shareholders, shall file a registration statement and a draft prospectus to the SEC to give investors time to study such information. However, some types of securities offering are not required to file such documents if the offering does not affect the general public. The offering of securities for sale is allowed upon:</p> <ul style="list-style-type: none"> (i) The SEC approval in case of newly issued shares; and (ii) The effectiveness of the registration filing. During the filing process, information shall be disclosed with discretion and within the limit of permitted scope. <p>3. Post-Offering Duties After offering securities for sale to the public, companies shall undertake securities settlement with the holders in accordance with the SEC regulations and disclose information on a continual basis to give investors information for making investment decision. Information of securities subject to public disclosure includes:</p> <ul style="list-style-type: none"> (i) Report of securities selling (ii) Report of rights exercising on convertible securities, i.e., warrants and convertible debentures (iii) Report of financial condition and operational performance, consisting of financial statements and annual reports (Form 56-1 and 56-2) (iv) Report of securities holding of the issuing company management <p>4. Regulatory transaction reporting requirements The SEC stipulates that all licensed dealers must report transactions of each bond to the Thai Bond Market Association (ThaiBMA) within 30 minutes after trade.</p> <p>Practically, trades are submitted to ThaiBMA within 15 minutes on average. All reports are scrutinized by the Monitoring and Surveillance department to ensure accuracy and integrity prior to compilation and dissemination to the general public and for the mark-to-market purpose.</p>

continued on next page

Table 14. continuation

Jurisdiction	Registration and Issuing Approval Procedure																																				
	<p>Filing and Approval criteria: 1. Plain debt (✓: means 'Yes,' 'exists' or 'required')</p> <table border="1"> <thead> <tr> <th style="background-color: #e0f2f1;">Filing</th> <th></th> </tr> </thead> <tbody> <tr> <td>1. Public Offering (PO)</td> <td>✓: Requires filing to SEC</td> </tr> <tr> <td>2. Non Retail Investor (NRI)</td> <td>✓: Requires filing to SEC Min. disclosure</td> </tr> <tr> <td>3. Exempt</td> <td>< 10 persons Treasury bill (T-bill), Government bond, Ministry of Finance (MOF) bond, Bank of Thailand (BOT) bond</td> </tr> </tbody> </table> <p>2. Complex debt (✓: means 'Yes,' 'exists' or 'required')</p> <table border="1"> <thead> <tr> <th style="background-color: #e0f2f1;">Filing</th> <th></th> </tr> </thead> <tbody> <tr> <td>1. PO</td> <td>✓: Requires filing to SEC</td> </tr> <tr> <td>2. NRI</td> <td>✓: Requires filing to SEC Min. disclosure</td> </tr> <tr> <td>3. Exempt</td> <td>< 10 persons T-bill, Government bond, MOF bond, BOT bond</td> </tr> </tbody> </table> <table border="1"> <thead> <tr> <th style="background-color: #e0f2f1;">SEC Approval Criteria</th> <th style="background-color: #e0f2f1;">Thailand</th> </tr> </thead> <tbody> <tr> <td>1. Plain Debt</td> <td></td> </tr> <tr> <td>1.1 PO</td> <td>✓: Requires SEC approval</td> </tr> <tr> <td>1.1.1 Eligible entities</td> <td>Local company and foreign company^a</td> </tr> <tr> <td>1.1.2 Others</td> <td> <u>Local Issuer</u> Both bond and foreign exchange bond: <ol style="list-style-type: none"> Never breach to offering rule Qualified executive w/o prohibited qualification Disclose the latest annual and quarter financial statement Rated by accepted credit rating agency (CRA) Register with ThaiBMA Foreign exchange bond: issuer required approval from BOT in relation to foreign exchange control (additional) <u>Foreign Issuer</u> Baht bond: approval from MOF Foreign exchange bond: <ol style="list-style-type: none"> Never breach to offering rule Disclose financial status (IFRS/FAS/US GAAP/other acceptable standard) Contract person in Thailand Offering debt in Thailand is not beach the issuance's country law IOSCO-signatory A Issuer requires approval from BOT in relation to foreign exchange control </td> </tr> <tr> <td>1.2 NRI</td> <td>✓: Approval in general easier</td> </tr> <tr> <td>1.2.1 Eligible entities</td> <td>Local company & foreign company</td> </tr> <tr> <td>1.2.2 Others</td> <td> <ol style="list-style-type: none"> Limited transferability Rated by accepted CRA Register with Thai Bond Market Association (< 10 persons, issuer is not required to comply with 2. and 3.) </td> </tr> <tr> <td>2. Complex</td> <td></td> </tr> <tr> <td>2.1 Underlying</td> <td>Local securities, local/foreign securities index, currency, gold, cash in/out flow, credit link, credit default</td> </tr> </tbody> </table>	Filing		1. Public Offering (PO)	✓: Requires filing to SEC	2. Non Retail Investor (NRI)	✓: Requires filing to SEC Min. disclosure	3. Exempt	< 10 persons Treasury bill (T-bill), Government bond, Ministry of Finance (MOF) bond, Bank of Thailand (BOT) bond	Filing		1. PO	✓: Requires filing to SEC	2. NRI	✓: Requires filing to SEC Min. disclosure	3. Exempt	< 10 persons T-bill, Government bond, MOF bond, BOT bond	SEC Approval Criteria	Thailand	1. Plain Debt		1.1 PO	✓: Requires SEC approval	1.1.1 Eligible entities	Local company and foreign company ^a	1.1.2 Others	<u>Local Issuer</u> Both bond and foreign exchange bond: <ol style="list-style-type: none"> Never breach to offering rule Qualified executive w/o prohibited qualification Disclose the latest annual and quarter financial statement Rated by accepted credit rating agency (CRA) Register with ThaiBMA Foreign exchange bond: issuer required approval from BOT in relation to foreign exchange control (additional) <u>Foreign Issuer</u> Baht bond: approval from MOF Foreign exchange bond: <ol style="list-style-type: none"> Never breach to offering rule Disclose financial status (IFRS/FAS/US GAAP/other acceptable standard) Contract person in Thailand Offering debt in Thailand is not beach the issuance's country law IOSCO-signatory A Issuer requires approval from BOT in relation to foreign exchange control 	1.2 NRI	✓: Approval in general easier	1.2.1 Eligible entities	Local company & foreign company	1.2.2 Others	<ol style="list-style-type: none"> Limited transferability Rated by accepted CRA Register with Thai Bond Market Association (< 10 persons, issuer is not required to comply with 2. and 3.) 	2. Complex		2.1 Underlying	Local securities, local/foreign securities index, currency, gold, cash in/out flow, credit link, credit default
Filing																																					
1. Public Offering (PO)	✓: Requires filing to SEC																																				
2. Non Retail Investor (NRI)	✓: Requires filing to SEC Min. disclosure																																				
3. Exempt	< 10 persons Treasury bill (T-bill), Government bond, Ministry of Finance (MOF) bond, Bank of Thailand (BOT) bond																																				
Filing																																					
1. PO	✓: Requires filing to SEC																																				
2. NRI	✓: Requires filing to SEC Min. disclosure																																				
3. Exempt	< 10 persons T-bill, Government bond, MOF bond, BOT bond																																				
SEC Approval Criteria	Thailand																																				
1. Plain Debt																																					
1.1 PO	✓: Requires SEC approval																																				
1.1.1 Eligible entities	Local company and foreign company ^a																																				
1.1.2 Others	<u>Local Issuer</u> Both bond and foreign exchange bond: <ol style="list-style-type: none"> Never breach to offering rule Qualified executive w/o prohibited qualification Disclose the latest annual and quarter financial statement Rated by accepted credit rating agency (CRA) Register with ThaiBMA Foreign exchange bond: issuer required approval from BOT in relation to foreign exchange control (additional) <u>Foreign Issuer</u> Baht bond: approval from MOF Foreign exchange bond: <ol style="list-style-type: none"> Never breach to offering rule Disclose financial status (IFRS/FAS/US GAAP/other acceptable standard) Contract person in Thailand Offering debt in Thailand is not beach the issuance's country law IOSCO-signatory A Issuer requires approval from BOT in relation to foreign exchange control 																																				
1.2 NRI	✓: Approval in general easier																																				
1.2.1 Eligible entities	Local company & foreign company																																				
1.2.2 Others	<ol style="list-style-type: none"> Limited transferability Rated by accepted CRA Register with Thai Bond Market Association (< 10 persons, issuer is not required to comply with 2. and 3.) 																																				
2. Complex																																					
2.1 Underlying	Local securities, local/foreign securities index, currency, gold, cash in/out flow, credit link, credit default																																				

continued on next page

Table 14. continuation

Jurisdiction	Registration and Issuing Approval Procedure		
	SEC Approval Criteria	Thailand	
	2.2 PO	✓: Requires approval from SEC	
	2.2.1 Eligible entities	Local company (a) Derivatives dealer (b) Commercial bank (underlying = gold, foreign exchange) (c) Cash inflow/outflow or main business are related to the reference underlying	
	2.2.2 Others	1. Never breach to offering rule 2. Qualified executive w/o prohibited qualification 3. Disclose the latest annual and quarter financial statement 4. Rated by accepted CRA 5. Register with Thai Bond Market Association 6. Redeemed value > 80% of par value 7. Issuer is not a related party of the underlying company	
	2.3 NRI	✓: Requires approval from SEC	
	2.3.1 Eligible entities	Local company – Derivatives dealer	
	2.3.2 Others	1. Limited transferability 2. Rated by accepted CRA 3. Register with Thai Bond Market Association (< 10 persons, issuer is not required to comply with 2. and 3.)	
3. Are the following regimes in place in jurisdiction?			
		YES NO	
	Private Placement Regime	X	
	Institutional Offerings Regime	X	
	Integrated Disclosure Regime ^b (including continuous disclosure)	X	
	Shelf Registration Regime	X	
4. Minimum lead time (number of business days) for registration approval			
		TIME PERIOD (MONTHS)	
	How long is the time period set which the regulator has to approve or disapprove the prospectus?	Offering corporate bond to Institutional Investor (II) and high net worth investor (HNWI) effective within the next business day as from the date of filing prospectus in full. Offering Corporate Bond to the Public (Public Offering) effective after the end of the 14-day period from the day the office receives prospectus in full.	
	How long in average is the prospectus reviewing period in your jurisdiction? (From the time of application until the approval/disapproval by the regulator)	About 20–30 days.	
5. Summary of regulation for issuing and offering of corporate bonds			
Corporate bond offering regulations can be summarized as follows;			
	Private Placement (PP)		Public Offering (PO)
	PP (Narrow Distribution/Small Size/Short term)	PP (II and HNWI)	
Distribution	Narrow Distribution 1. < 10 person or 2. For debt restructuring or 3. Overseas institutional investors 4. Convertible bond sold to the existing shareholders or 5. Total number of the bill issued are less than ten	II and HNWI	General investors including individuals

continued on next page

Table 14. continuation

Jurisdiction	Registration and Issuing Approval Procedure		
		Private Placement (PP)	Public Offering (PO)
		PP (Narrow Distribution/Small Size/Short term)	PP (II and HNWI)
	Issue size (Stock Exchange of Thailand Rule for Listing Qualification)	In case of small (less than THB100 million), cannot be listed (Unlisted)	Not less than THB100 million - can be listed.
	Short term bills	SEC Filing Not required (Exempt)	Require filing to SEC
	SEC Filing of the registration statement and draft prospectus	SEC Filing Not required (Exempt)	SEC Filing Required but Light (Free form, 1-day processing) <i>Notification of the Capital Market Supervisory Board No. TorChor.10/2552 clause 18 (1) (please see the attachment file)</i>
	Continuous Disclosure requirement	Not required (Exempt)	Require same disclosure at the same time that send to lead regulator
	Rating	Not required (Exempt)	Required, but Issue, Issuer, Guarantor rating (any can be used)
	ThaiBMA registration	Not required (Exempt)	Required (newly issued bond)
	Bond representative	Not required (Exempt)	Required
	<p>a. The bond can be offered for sale by way of PO or PP. PP generally means to offer for sale to institutional investors, high net worth investors, and specific investors.</p> <p>b. Approval from the SEC is required for the offer for sale by way of a Public Offering. A full filing form (a specific form prescribed by the SEC) and draft prospectus have to be submitted to the SEC.</p> <p>c. PP (Narrow Distribution/Small Size) is exempt from filing requirement.</p> <p>d. PP (II and HNWI) is exempt from full filing requirement. (Light requirement remains).</p> <p>e. The concept of II or Qualified Foreign Institutional Investor (QFII) does not only apply to securities available for sale in the Exchange Market but also applies to debentures issued by way of private placement.</p> <p>f. A credit rating is also required for an offer for sale by way of a PO and PP.</p> <p>g. The newly issued bond must be registered with the ThaiBMA.</p> <p>h. A bond representative is needed for an offer for sale by way of a PO.</p> <p>i. An annual report is required to be filed with the SEC.</p>		
Viet Nam	<p>A key legislation regulating securities and the securities market is the <i>Securities Law 2006 (No. 70/2006/QH11)</i>, which took effect on 1 January 2007.</p> <p>The scope of the law covers the public offers of securities, listing and trading securities, conducting business and investing in securities, securities services and the securities market.</p> <p>Issue authorization and disclosure duties for public offering bonds are as follows: After registration, actual (corporate) bond issues should obtain the State Securities Commission's (SSC) authorization for issuance of bonds with a set of disclosure information.</p> <p>1. Conditions for Offering Bonds to the Public</p> <p>a. The enterprise must have its paid-up charter capital at the time of registration for public offering of at least VND10 billion in book value;</p> <p>b. Being profit making in the year preceding the year of such registration for offering, it must have no accumulated losses up to the year of registration for offering or overdue debts of over 1 year.</p> <p>c. It must have a plan for offering and use and refund of capital received from the offering approved by the Board of Management, Board of Members, or the enterprise's owner.</p> <p>d. It must commit to fulfill obligations of the issuer towards investors, meet conditions for issuance and payment, and ensure investors' legitimate rights and interests, and other conditions.</p>		

continued on next page

Table 14. continuation

Jurisdiction	Registration and Issuing Approval Procedure
	<p>2. Condition for Offering Securities to the Public, Overseas, and Other Specific Cases The government shall stipulate the conditions for offering securities to the public applicable to state-owned enterprises (SOEs); foreign-invested enterprises (FIEs), which are transformed into joint stock companies; and newly established enterprises in the fields of infrastructure or high technology. It shall also set out the conditions for offering securities overseas and other specific cases.</p> <p>3. Registration of Offering Securities to the Public</p> <ol style="list-style-type: none"> a. The issuer carrying out the offering of securities to the public shall have to register with the SSC. b. The following cases shall not be subject to registration for offering securities to the public: <ol style="list-style-type: none"> i. Offering of bonds of the Vietnamese Government; ii. Offering of international financial institutions' bonds accepted by the Vietnamese Government; iii. Offering of shares to the public by SOEs, which are transformed into joint stock companies; and iv. The sale of securities upon a court judgment or decision, or the sale of securities by the managers or the persons entitled to assets in case of bankruptcy or insolvency. <p>4. Information prior to Public Securities Offering At time the SSC reviews the public securities offering registration dossier, the issuer, the underwriter(s), and other relevant organizations and individuals may only use, in an honest and accurate manner, the information described in the prospectus submitted to the SSC to explore the market, provided that they shall clearly specify that the information on the date of issue and the securities selling price is the proposed information. Exploring the markets must not be conducted through the mass media.</p> <p>5. Effectiveness of the Public Securities Offering Registration</p> <ol style="list-style-type: none"> a. Within 30 days from the date of receipt of the valid dossier, the SSC shall examine and grant the Certificate for Public Securities Offering. In case of refusal, it must respond in writing and clarify the reasons thereof. b. The Certificate for Public Securities Offering granted by the SSC shall be a document certifying that the public securities offering registration dossier fully satisfies the conditions and procedures provided by law. c. Within 7 days from the date the Certificate for Public Securities Offering comes into effect, the issuer shall publish the Announcement of Offering in three consecutive issues of one electronic newspaper or written newspaper. d. The securities shall only be offered to the public after the announcement has been made, as stipulated in clause 3 of this Article.
<p>^a Baht bond: International financial institution or foreign government or multinational corporation in ASEAN+3 countries.</p> <p>^b An integrated disclosure regime which allows the issuer to incorporate by reference continuous disclosure documents into its public offering documents, thereby easing the disclosure burden of public offerings. It allows the qualified issuer to file disclosure documents for a new public offer by incorporating continuous disclosure documents by reference and minimizes the redundancies.</p> <p>FAS = Financial Accounting Standards; IFRS = International Financial Reporting Standards; IOSCO = International Organization of Securities Commission; US GAAP = US Generally Accepted Accounting Principles</p> <p>Source: ADB Consultants, based on research materials and market visit information.</p>	

XV. Necessity of Disclosure of Ultimate Beneficial Owner

Table 15. Necessity of Disclosure of Ultimate Beneficial Owner

Jurisdiction	Regulators' Policy related to the Necessity of Disclosure of Ultimate Beneficial Owner	Direct or Indirect Account Holding System
People's Republic of China	Yes. Beneficial Owner to be disclosed	
Hong Kong, China	No policy	Both
Indonesia	No requirement by law. Typically grouped by tax rate/domicile.	Both
Japan	No policy	Direct (Account holders have the rights directly against issuers)
Republic of Korea	No policy	Direct
Malaysia	No policy	Both
Philippines	No policy	Registered holders have legal rights against the Issuer.
Singapore	No policy	Both
Thailand	No policy	Both
Viet Nam	No policy	Indirect

Source: ADB Consultants, based on research materials and market visit information.

XVI. Foreign Exchange and Currency-Related Restrictions

Table 16. Foreign Exchange and Currency-Related Restrictions

Jurisdiction	Foreign Exchange Rate Floating	Restrictions on Foreign Remittance (1. Own currency) (2. Investment principal) (3. Coupons/dividends)	Currencies eligible for Continuous Linked Settlement Bank Settlement
People's Republic of China	Government controlled floating, rate referring to currency basket	1. Restricted	-
		2. Restricted for certain period of time after investment	
		3. Restricted for certain period of time after investment	
Hong Kong, China	Link to US dollar (Currency Board System)	1. No restriction	Yes
		2. No restriction	
		3. No restriction	
Indonesia	Floating	1. Restricted. (Rupiahs foreign-exchange trades must be done by Indonesian domestic banks, rupiah remittance between foreign banks is prohibited)	-
		2. No Reporting required for repatriation of benefits.	
		3. Reporting required	
		(*) Real-demand principle applies to inbound foreign exchange or buy Indonesian rupiah only.	
Japan	Floating	1. No restriction	Yes
		2. No restriction. (ex post facto report required)	
		3. No restriction. (ex post facto report required)	
Republic of Korea	Floating	1. Restricted	Yes
		2. No restriction	
		3. No restriction	
Malaysia	Managed float against a basket of currencies, following the de-pegging of the ringgit	1. Restricted (All remittance out of the country must be made in foreign currency). Real-demand principle applies to inbound foreign exchange only.	-
		2. No restriction for non-resident investors to repatriate in foreign currency.	
		3. No restriction for non-resident investors to repatriate in foreign currency.	
Philippines	Floating	1. Restricted. Registration with Bangko Sentral ng Pilipinas (BSP) for issuance of Bangko Sentral Registration Document (BSRD) on per transaction basis is required to qualify for automatic conversion of peso sale/interest into foreign exchange for outward repatriation.	-
		2. Registration with BSP for issuance of BSRD on per transaction basis is required to qualify for automatic conversion of peso sale/interest into foreign exchange for outward repatriation.	
		3. Interest automatically qualifies for outward repatriation if principal investment has BSRD.	
Singapore	Floating against basket of currencies	1. No restrictions (investor can hold Singapore dollar in, e.g., Tokyo)	Yes
		2. No restriction	
		3. No restriction	
Thailand	Managed Floating	1. Restricted	-
		2. Reporting is required.	
		3. Reporting is required.	
Viet Nam	Controlled Floating	1. Restricted	-
		2. Restricted for certain period of time after investment	
		3. No restriction	
		(Viet Nam issue is based on availability of foreign currency.)	

Source: ADB Consultants, based on research materials and market visit information.

XVII. Omnibus Securities Account and Nominee Concept

Table 17. Omnibus Securities Account and Nominee Concept

Jurisdiction	Existence of Omnibus Securities Account	Existence of Nominee Concept
People's Republic of China	No. Securities must be kept in the name of the beneficiary owner.	No.
Hong Kong, China	Yes.	Yes.
Indonesia	Yes.	Yes.
Japan	Yes.	Yes.
Republic of Korea	<p>Yes.</p> <p>But, the foreign exchange regulation in Korea does not allow omnibus accounts for payments for foreign investors. To avoid this, foreign investors who use international central securities depositories (ICSDs) have the status of a Qualified Financial Intermediary (QFI) and are allowed to use omnibus accounts. (See details below).</p> <p>Foreigners who invest in Korean domestic bonds normally depend on local or global custodians to settle their transactions and keep the bonds they have acquired. In making settlement for securities transactions, custodians usually use omnibus accounts through which they consolidate all of their clients' transactions into a single account and make payments and deliveries using that account. The foreign exchange regulation in Korea, however, requires that payments to settle securities transactions by foreigners must be processed through the individual account of each foreign investor. Since omnibus accounts for payments are not allowed for foreign investors, the custodian banks in charge of settling the bond transactions of foreign investors have to make payments through the individual account of each foreign investor.</p> <p>Prior to 2007, ICSDs did not provide settlement service for Korean bonds because the use of omnibus accounts by foreign investors was prohibited. As a consequence, it is plausible that Republic of Korea may have been losing potential foreign investments from those who would have invested in Korean bonds had they been able to settle their transactions through ICSDs.</p> <p>To address this shortcoming, the Korean government allowed ICSDs to use omnibus accounts to settle transactions of domestic bonds by foreign investors.</p> <p>The revised regulation stipulates that Clearstream and Euroclear can provide settlement services for the country's government bonds and Monetary Stabilization Bonds (MSBs) through their omnibus accounts set up at the Korea Securities Depository.</p> <p>Allowing omnibus accounts not only provides foreign investors with the benefit of lower cost and convenience in settlement, but also enables them to avoid significant institutional impediments. First, foreign investors do not have to register with the Financial Supervisory Service and get an investment registration certificate in advance if they settle their transactions of Korean domestic bonds through an ICSD. They can simply hold Korean domestic bonds at the representative omnibus account under the title of an ICSD. In addition, the new regulation enables over-the-counter (OTC) transactions of Korean domestic bonds when these are deposited in and settled through the omnibus accounts of an ICSD. As a result, a foreign investor may now sell Korean government bonds to another foreign investor through a direct OTC transaction when both parties engage in the transaction via financial institutions that have settlement accounts at an ICSD.</p> <p>Allowing ICSDs to make settlements using a representative omnibus account, however, may cause some problems in relation to the income tax exemption for foreigners. As was mentioned earlier, the Korean government decided to give foreign investors exemption from withholding tax on interest income from government bonds and MSBs in January 2009.</p> <p>Since foreign investors no longer need an investment registration certificate if they settle their transactions through the omnibus account of an ICSD, a domestic investor can easily disguise himself as a foreign investor by making settlement through an ICSD to gain a tax exemption on interest income.</p> <p>Under this system, the settling members of ICSDs that acquire QFI status are allowed to make settlement of Korean domestic bond transactions for their customers through the omnibus accounts of ICSDs.</p> <p>In order to qualify as a QFI, a financial institution is required to assess customer adequacy of foreign investors for tax exemption and keep track of the bond transactions and holding records of foreign investors so that they can report to Korea's National Tax Service as necessary.</p> <p>In spite of the clear benefits, the use of omnibus accounts is an exception rather than a rule. It is only the ICSDs that are allowed to use omnibus accounts.</p> <p>Therefore, foreign investors who do not settle their domestic bond transactions through ICSDs are still subject to restrictions such as registration requirements, prohibition of direct OTC transactions between foreign investors, and prohibition on the use of omnibus accounts.</p>	<p>Yes.</p> <p>But it cannot be applied to foreign investment in bonds.</p>
Malaysia	Yes.	Yes.
Philippines	Yes.	Yes.
Singapore	Yes.	Yes.
Thailand	Yes.	Yes.
Viet Nam	Yes.	No.

Source: ADB Consultants, based on research materials and market visit information.

XVIII. Main Trading Places (Over the Counter or Exchange) and Existence of Exchange trading

Table 18. Main Trading Places (Over the Counter or Exchange) and Existence of Exchange Trading

Jurisdiction	Is the Over-the-Counter Market a Main Trading Place?	Exchange Market Trading
People's Republic of China	Yes, Inter-bank Bond Market, not directly available to foreign investors. Domestic institutions are permitted to trade in the over-the-counter (OTC) market.	Yes (Shanghai Stock Exchange and Shenzhen Stock Exchange).
Hong Kong, China	Yes	Yes (Hong Kong Stock Exchanges and Clearing), but only accounts for a relatively small portion of all the trading in bonds.
Indonesia	Yes	Possible, but hardly observed.
Japan	Yes	No.
Republic of Korea	Yes	Yes (Korea Exchange). Government Bonds.
Malaysia	Yes (Only for unlisted debt securities)	No.
Philippines	Yes	No.
Singapore	Yes	Yes. (Government Bonds, mainly for retail investors, 2011-)
Thailand	Yes. Bond Electronic Exchange provides electronic platform for OTC fixed-income trading named Fixed-Income and Related Securities Trading System.	No.
Viet Nam	Yes, but not yet regulated.	No.

Source: ADB Consultants, based on research materials and market visit information.

XIX. Listing of Bonds and Obligation for Market Listing (Domestic Market)

Table 19. Listing of Bonds and Obligation for Market Listing (Domestic Market)

Jurisdiction	Name of Exchange	Obligation for Market Listing	Purpose of the Listing
People's Republic of China	Shanghai Stock Exchange and Shenzhen Stock Exchange	Yes for Exchange Market. No for Inter-bank Bond Market.	Profiling and real listing for trading
Hong Kong, China	The Stock Exchange of Hong Kong	No.	Profiling, regulatory and price discovery purposes
Indonesia	Indonesia Stock Exchange	No.	Profiling
Japan	Tokyo Stock Exchange TOKYO AIM (TOKYO PRO-BOND Market)	No.	Profiling
Republic of Korea	Korea Exchange	No.	Profiling
Malaysia	Bursa Malaysia	No.	Profiling
Philippines	Philippine Dealing and Exchange for onshore trading of fixed-income securities.	No.	Profiling
Singapore	Singapore Exchange Securities Trading: listed fixed income Inter-bank money market: Unlisted fixed income	No.	Profiling/Trading
Thailand	Bond Electronic Exchange	No.	Profiling
Viet Nam	Ho Chi Minh Stock Exchange Hanoi Stock Exchange	Yes.	Profiling

Source: ADB Consultants, based on research materials and market visit information.

XX. Necessity of Credit Rating for the Issuing of Bonds

Table 20. Necessity of Credit Rating for the Issuing of Bonds

Jurisdiction	Obligation to acquire rating at the issuance of the bond	Remarks
People's Republic of China	Yes.	All the issues are rated AAA. There is no accumulation of default data, hence difficult to diversify the issuance.
Hong Kong, China	No.	There are no credit rating agencies (CRAs) based exclusively in Hong Kong. However, the three largest international CRAs have offices in this jurisdiction, alongside several smaller multinational CRAs. In view of the revised Code of Conduct Fundamentals for Credit Rating Agencies issued by the International Organization of Securities Commissions in May 2008 and the Declaration on Strengthening the Financial System made by the Group of Twenty on 2 April 2009, the Securities and Futures Commission (SFC) is proposing to introduce a regulatory framework to strengthen its oversight of CRAs. Refer to the Consultation Paper and Consultation Conclusions Concerning the Regulatory Oversight of Credit Rating Agencies, which are published in the SFC's website.
Indonesia	Yes.	Issuer who will issue debit security or bond (efek bersifat utang, EBU) should obtain rating of referred EBU from a CRA, based on Peraturan Bapepam dan LK nomor IX.C.11: Pemingkatan EBU, who is holding a business license from Bapepam-LK based on Peraturan Nomor V.C.2: Perizinan Perusahaan Pemingkat Efek. Rating is an opinion from CRA concerning the ability of parties who are rated to meet payment obligations in a timely manner (company rating) and/or related to the securities issued by referred parties (instrument rating). Ratings could be done to: a. EBU, Sukuk, Asset-Backed Securities or other rated securities; b. Party as an entity, including Mutual Funds and Real Estate Investment Trust in form of a Collective Investment Contract. PT ICRA Indonesia, PT Pemingkat Efek Indonesia and PT Fitch Ratings Indonesia are the existing CRAs in Indonesia. Indonesia is the only jurisdiction that imposes rating requirements for bonds seeking listing status.
Japan	No. But, TOKYO PRO-BOND Market Listing requires Credit Rating	Credit rating was introduced in Japan in the 1980s, and it has become general practice in issuing of and investing in corporate bonds. In Japan, bonds with a credit rating of BB, B, CCC, CC, or C, which are called "junk bonds" or "high yield bonds," did originally not exist in the primary market because of a policy that excluded bonds that did not meet the eligibility standards established by the market participants. However, today there are no such regulations because the eligibility standards were abolished in 1996. Nevertheless, few BBB-rated bonds, let alone junk bonds, have been offered in the market. Qualification Requirements for Initial Listing Companies on the TOKYO PRO-BOND Market: The Initial Listing Applicant must satisfy all of the requirements listed below when listing bonds on the TOKYO PRO-BOND Market: The said bonds obtain a credit rating from a credit rating agency (meaning registered credit rating agencies stipulated in Article 2, Paragraph 36, of the Financial Instruments and Exchange Act and rating agencies established under foreign laws that are subject to frameworks of regulations and supervision equivalent to those of registered credit rating agencies.). A credit rating for the above-mentioned Program Information may be used as the credit rating.
Republic of Korea	Yes.	When a company issues corporate bonds in order to raise long term capital for over one year from the direct financing market, they are required to obtain a credit rating from a specialized credit rating agency for all non-guaranteed bonds in order to protect small-cap investors who lack professional knowledge on the issuer, and in order to induce a reasonable price in the bond market. All non-guaranteed corporate bonds, excluding government bonds and bonds, for which the government has guaranteed the payment of principal and interest, as well as municipal bonds and monetary stabilization bonds issued by the Bank of Korea, must receive a credit rating in order to be included in the trust assets of banks and investment trust companies. In other words, bonds being issued without guarantee including those by ordinary companies, specialized lenders, financial investment firms, commercial banks, the Korea Development Bank, government-funded agencies and pension funds, must first receive a credit assessment from a specialized credit rating agency. Corporate bonds' credit ratings are used as criteria for deciding upon investment when issuing and trading non-guaranteed bonds.

continued on next page

Table 20. continuation

Jurisdiction	Obligation to acquire rating at the issuance of the bond	Remarks
Malaysia	Yes.	In Malaysia, all debt securities and <i>Sukuk</i> issues are required to be accompanied by a credit rating at all times. Private Debt Securities Guidelines (Extract) Revised: 12 July 2011/Effective: 12 August 2011 Securities Commission (SC) Deemed approval process for ringgit-denominated private debt securities 5.03 Notwithstanding paragraph 5.01, a proposed issue, offer or invitation of ringgit-denominated private debt securities (including a debt program) will be deemed approved by the SC upon fulfilling the following conditions: (a) The issue, offer or invitation has either (i) been assigned a local rating of AAA by a domestic credit rating agency registered with the SC or, (ii) subject to the requirements stated in paragraph 5.04, been assigned an international rating of at least BBB- (or its equivalent) or a regional rating of AAA by an international credit rating agency;
Philippines	Yes.	As a general rule under Securities Regulation Code Rule 12.1-6, all commercial papers or evidences of indebtedness are required to be rated by a rating agency accredited by the Securities and Exchange Commission, except: (1) Government and government-guaranteed debt securities; or (2) Issuance amounting to not more than 25% of the issuer's net worth; or (3) Where there is an irrevocable committed credit line with a bank covering 100% of the proposed issuance.
Singapore	No. But, As a foreign debt securities listing requirement of Singapore Exchange (SGX), the issue of debt securities must have a credit rating of investment grade and above.	Singapore does not have any home-grown credit rating agencies, but instead relies on international rating services. As a foreign debt securities listing requirement of SGX, the issue of debt securities must have a credit rating of investment grade and above. The same requirements apply for the listing of local debt securities, with the additional requirement that for the Issuer qualifying under the listing requirements, the issue of debt securities must have a principal amount of at least SGD750,000. Credit Rating requirements: Under the Securities and Futures (Offers of Investments) (Shares and Debentures) Regulations 2005, where the issuer or the bonds being offered have been given a credit rating by a credit rating agency, the following should be disclosed in the prospectus: (a) The name of the CRA; (b) The credit rating (including whether it is a short-term or long-term credit rating); (c) Whether or not the relevant entity, its guarantor entity or any of their related parties had paid any fee or benefit of any kind to the CRA in consideration for the credit rating; and (d) The date on which the credit rating was given.
Thailand	Yes.	According to the Securities and Exchange regulations, newly issued debentures to public offering (PO) issues must have a credit rating from an authorized credit rating agency. Most private placement (PP) issues are also required to have a credit rating but on the basis of more relaxed regulation. To elaborate on this, PO issues need to have issue ratings; PP issues can choose to have either issue or issuer ratings; PP with limited distribution (i.e., fewer than 10 investors) is exempted from ratings.
Viet Nam	No.	Currently, there is no domestic credit rating agency in this country. Global rating agencies such as Standard & Poor's (S&P), Moody's Investor Service, Fitch Ratings, and Rating and Investment Information (R&I) have assigned credit ratings for Viet Nam. Viet Nam's first credit rating agency, Viet Namnet Credit Ratings Centre, opened in June 2005, but discontinued its operations after less than 1 year.

Source: ADB Consultants, based on research materials and market visit information

XXI. Documentation Language

Table 21 Documentation Language

Jurisdiction	Main language	Alternative language
People's Republic of China	Chinese	
Hong Kong, China	English	Chinese
Indonesia	Bahasa Indonesia	English

continued on next page

Table 21. continuation

Jurisdiction	Main language	Alternative language
Japan	Japan*	English for TOKYO-PRO BOND Market Listing
Republic of Korea	Korean (Hangul)	
Malaysia	English	
Philippines	English	
Singapore	English	
Thailand	Thai	English
Viet Nam	Vietnamese	

* Japan is in the process of introducing a partial English-based documentation for disclosure from April 2012; Although the information for securities should be submitted in Japanese, most disclosure information for the issuer (including already disclosed reference information) can be submitted in English, except for some specific information. Non-resident issuers' burden will, thus, be reduced.

Source: ADB Consultants, based on research materials and market visit information.

XXII. Concept/Definition of Professional or Institutional investors

Table 22. Concept and Definition of Professional or Institutional investors

Jurisdiction	Concept and Definition of Professional or Institutional investors	Remarks
China	<ul style="list-style-type: none"> No concept or definition of 'professional' (investor) evident in Chinese law. Professional is often taken synonymous to 'experienced.' 	<ul style="list-style-type: none"> The People's Bank of China is considering the concept of Qualified Institutional Buyer (QIB), i.e., a professional investor category, with related disclosure and even potentially specific instruments for this investor category.
	The Inter-bank Bond Market is the over-the-counter (OTC) market for institutional investors. Investment bodies include all types of institutional investors such as commercial banks, insurance companies, securities companies, funds management companies, enterprises and public institutions. At present, the Inter-bank Bond Market has over 10,000 members, covering all types of financial institutions such as commercial banks, securities companies, insurance companies, and various kinds of investment products like mutual funds and pension funds, among which commercial banks are the most active participants.	
Hong Kong, China	<ul style="list-style-type: none"> A "professional investor" includes any authorized financial institution, any recognized exchange company, recognized clearing house, any authorized insurer, any investment services intermediary, collective investment scheme, any government institution that performs the functions of a central bank, and any person of a class which is prescribed by rules under section 397 of the SFO (section 1 of Part 1 of Schedule 1 to the SFO). An offer to sell bonds to professional investors is not required to comply with the prospectus requirements in the Companies Ordinance (CO) as stipulated in the Exemption in Paragraph 1 of Schedule 17 to the CO. This is contrasted with a general offer of bonds to the public, which has to comply with a prospectus requirements in the CO. 	
Indonesia	Indonesia does not have specific definitions on this type of professional investors.	Bapepam-LK is working on definitions of professional/ individual investors.
Japan	<ol style="list-style-type: none"> The following categories are specified (professional) investors. <ol style="list-style-type: none"> Qualified Institutional Investors (meaning persons specified by a Cabinet Office Ordinance as those having expert knowledge of and experience with investment in Securities); The State (Japan); The Bank of Japan; and Investor Protection Funds, and other juridical persons specified by a Cabinet Office Ordinance (excluding those that are deemed to be non-specified investors according to agreements (opt-out)). Corporations and individuals that are deemed to be specified investors according to agreements (opt-in).^a Qualified Institutional Investors (QIIs) QIIs include securities companies, investment management companies, investment corporations, foreign investment corporations, banks, insurance companies, certain pension funds, general partners of certain partnerships. Juridical persons referred to companies whose shares are listed on stock exchange(s) in Japan, companies whose stated capital is likely to be JPY500 million or more and foreign corporations. 	

continued on next page

Table 22. continuation

Jurisdiction	Concept and Definition of Professional or Institutional investors	Remarks																																																							
Republic of Korea	<p>The <i>Financial Investment Service and Capital Market Act (FSCMA)</i> classifies an ordinary investor and a professional investor based on the expertise of their professional knowledge and experience as well as the amount of assets.</p> <p>A professional investor refers to an investor who does not need any strong investor protection measures considering its own expertise and experience, such as a nation, a local municipality, a central bank, and a financial institution. Most individual investors fall under the classification of an ordinary investor with the exception of an investor whose financial investments exceeds KRW5 billion. Such classification aims to protect ordinary investors from taking huge risks in making investment due to the lack of such understanding of the financial investment instruments.</p> <p>Professional investors are;</p> <ol style="list-style-type: none"> The State; The Bank of Korea; Financial institutions specified by Presidential Decree; ref. Enforcement Decree of FSCMA article 10 (Scope of Professional Investors) Stock-listed corporations: Provided, That trading OTC derivatives with a financial investment business entity shall be limited to cases where an investor notifies the financial investment business entity in writing of its willingness to be treated as a professional investor; and Other persons specified by Presidential Decree. <p>In May 2012, Republic of Korea will launch a QIB market which is based on an exempt regime for Professional Investors.</p>																																																								
Malaysia	<p>The term - Sophisticated Investor is not explicitly defined in the <i>Capital Markets and Services Act 2007 (CMSA)</i>. However, Schedules 6 and 7 of the CMSA exempt these types of issues and offers to so-called sophisticated or professional investors and their transactions from prospectus requirements. In an effort to promote the Malaysian debt securities and <i>Sukuk</i> market whilst enhancing the breadth and depth of investment options on the Malaysian capital market, debt securities and <i>Sukuk</i> can now be listed on Bursa Malaysia under a new exempt regime by both listed and non-listed issuers. This framework is applicable to debt securities and <i>Sukuk</i> that are issued, offered or subscribed in accordance with section 229(1) and section 230(1) of the CMSA (i.e., an issue, offer or invitation of debenture to investors who do fall within Schedule 6 and Schedule 7 of the CMSA). This regime especially caters to issuers who intend to list their debt securities and <i>Sukuk</i> for listing status and profiling purpose. The targeted groups of investors for these securities are sophisticated or professional investors and not retail investors. By an exempt regime, it means that the debt securities or <i>Sukuk</i> which are listed on the Exchange will not be quoted nor traded on the Exchange. As stated above, under the exempt regime, prospectus exemption is adapted to the offers of bonds to sophisticated investors. See below for Quick Reference of Breakdown for Sophisticated Investors based on the <i>Public Consultation Paper No. 1/2010</i> dated 19 March 2010.</p> <table border="1"> <thead> <tr> <th rowspan="2"></th> <th colspan="3">Sophisticated Investor</th> </tr> <tr> <th>Sophisticated Investor</th> <th>Professional Investor</th> <th>Qualified Investor</th> </tr> </thead> <tbody> <tr> <td>• A unit trust scheme or prescribed investment scheme;</td> <td>✓</td> <td></td> <td></td> </tr> <tr> <td>• A holder of a Capital Markets and Services License who carries on the business of dealing in securities;</td> <td>✓</td> <td>✓</td> <td></td> </tr> <tr> <td>• A holder of a Capital Markets and Services License who carries on the business of fund management;</td> <td>✓</td> <td>✓</td> <td></td> </tr> <tr> <td>• The aggregate consideration for the acquisition is not less than RM250,000 or its equivalent in foreign currencies for each transaction whether such amount is paid for in cash or otherwise;</td> <td>✓</td> <td></td> <td></td> </tr> <tr> <td>• An individual whose total net personal assets exceed RM3 million or its equivalent in foreign currencies;</td> <td>✓</td> <td></td> <td>✓</td> </tr> <tr> <td>• A corporation with total net assets exceeding RM10 million or its equivalent in foreign currencies based on the last audited accounts;</td> <td>✓</td> <td>✓</td> <td></td> </tr> <tr> <td>• A licensed offshore bank under the Offshore Banking Act 1990;</td> <td>✓</td> <td>✓</td> <td></td> </tr> <tr> <td>• A licensed offshore insurer under the Offshore Insurance Act 1990;</td> <td>✓</td> <td>✓</td> <td></td> </tr> <tr> <td>• A licensed institution under the Banking and Financial Institution Act 1989 or an Islamic Bank under the Islamic Banking Act 1983;</td> <td></td> <td>✓</td> <td></td> </tr> <tr> <td>• An insurance company registered under the Insurance Act 1996;</td> <td>✓</td> <td></td> <td></td> </tr> <tr> <td>a. A statutory body established by an Act of Parliament or an enactment of any State;</td> <td>✓</td> <td></td> <td></td> </tr> <tr> <td>b. A pension fund approved by the Director General of Inland Revenue;</td> <td>✓</td> <td></td> <td></td> </tr> </tbody> </table>		Sophisticated Investor			Sophisticated Investor	Professional Investor	Qualified Investor	• A unit trust scheme or prescribed investment scheme;	✓			• A holder of a Capital Markets and Services License who carries on the business of dealing in securities;	✓	✓		• A holder of a Capital Markets and Services License who carries on the business of fund management;	✓	✓		• The aggregate consideration for the acquisition is not less than RM250,000 or its equivalent in foreign currencies for each transaction whether such amount is paid for in cash or otherwise;	✓			• An individual whose total net personal assets exceed RM3 million or its equivalent in foreign currencies;	✓		✓	• A corporation with total net assets exceeding RM10 million or its equivalent in foreign currencies based on the last audited accounts;	✓	✓		• A licensed offshore bank under the Offshore Banking Act 1990;	✓	✓		• A licensed offshore insurer under the Offshore Insurance Act 1990;	✓	✓		• A licensed institution under the Banking and Financial Institution Act 1989 or an Islamic Bank under the Islamic Banking Act 1983;		✓		• An insurance company registered under the Insurance Act 1996;	✓			a. A statutory body established by an Act of Parliament or an enactment of any State;	✓			b. A pension fund approved by the Director General of Inland Revenue;	✓			
	Sophisticated Investor																																																								
	Sophisticated Investor	Professional Investor	Qualified Investor																																																						
• A unit trust scheme or prescribed investment scheme;	✓																																																								
• A holder of a Capital Markets and Services License who carries on the business of dealing in securities;	✓	✓																																																							
• A holder of a Capital Markets and Services License who carries on the business of fund management;	✓	✓																																																							
• The aggregate consideration for the acquisition is not less than RM250,000 or its equivalent in foreign currencies for each transaction whether such amount is paid for in cash or otherwise;	✓																																																								
• An individual whose total net personal assets exceed RM3 million or its equivalent in foreign currencies;	✓		✓																																																						
• A corporation with total net assets exceeding RM10 million or its equivalent in foreign currencies based on the last audited accounts;	✓	✓																																																							
• A licensed offshore bank under the Offshore Banking Act 1990;	✓	✓																																																							
• A licensed offshore insurer under the Offshore Insurance Act 1990;	✓	✓																																																							
• A licensed institution under the Banking and Financial Institution Act 1989 or an Islamic Bank under the Islamic Banking Act 1983;		✓																																																							
• An insurance company registered under the Insurance Act 1996;	✓																																																								
a. A statutory body established by an Act of Parliament or an enactment of any State;	✓																																																								
b. A pension fund approved by the Director General of Inland Revenue;	✓																																																								

continued on next page

Table 22. continuation

Jurisdiction	Concept and Definition of Professional or Institutional investors	Remarks
Philippines	<p>1. Under the <i>Securities and Exchange Commission (SEC) Memorandum Circular No.14, Series of 2006, the Rules Governing the Over-the-Counter (OTC) Market (OTC Rules)</i>, “qualified investor” refers to any of the qualified buyers defined under section 10 (10.1 (L)) of the Securities Regulatory Code (SRC), any of the institutional accounts defined under SRC Rule 52.1, 6, D, or such other person declared by the SEC by rule or order as a qualified investor. In doing so, the SEC takes into account the person’s net worth or financial background would allow him or her to bear the risk that may arise from participating in an OTC market. Pursuant to its authority prescribed under the SRC, the SEC issued SEC Memorandum Circular No.6, Series of 2007, “Definition of Qualified Buyers (Qualified Buyer Rules)” under section 10 of the SRC” to prescribe regulations on determining individual or juridical persons that may be registered as qualified buyers.</p> <p>A qualified individual buyer shall be a natural person who:</p> <ul style="list-style-type: none"> a. Has a minimum annual gross income of PHP25 million at least 2 years prior to registration, or a total portfolio in securities of at least PHP10 million registered with the SEC, or a personal net worth of at least PHP30 million; and b. Has been engaged in securities trading in his personal capacity, or through a fund manager, for a period of 1 year, or held for at least 2 years a position of responsibility in any professional or business entity that requires knowledge or expertise in securities trading. <p>A qualified institutional buyer shall have: a minimum annual gross income of PHP100 million at least 2 years prior to registration, or a total portfolio in securities of at least PHP60 million registered with the SEC, or a personal net worth of at least PHP100 million. Investors who do not qualify under the definition of a qualified investor are considered public or retail investors.</p> <p>2. Debt securities may not be offered for sale to the public, unless these securities are registered in accordance with sections 8 (SRC Rule 8.1) and 12 (SRC Rule 12.1) of the SRC. However, securities that are exempt from registration under section 9 (Exempt Securities) (SRC Rule 9.2) and section 10 (Exempt Transactions) (SRC Rule 10.1) of the SRC, respectively, may be offered for sale to the public.</p> <p>Here, SRC Rule means “Implementing Rules and Regulations of the Securities Regulation Code.”</p> <p>SRC Section 10.1 (k) mentions that the sale of securities by an issuer to fewer than twenty (20) persons in the Philippines during any 12-month period is an exempt transaction. SRC Section 10.1 (k) is known as Private Placement in Philippines.</p> <p>SRC Section 10.1 (L) mentions that the sale of securities to any number of the qualified buyers is an exempt transaction. In relation to this, the ‘Qualified Institutional Buyer’ concept and the criteria for institutional vs. individual professional investors were laid out (added) by the SEC in 2007 through Qualified Buyer Rules, as stated above.</p> <p>3. Qualified Buyer are as follows:</p> <ul style="list-style-type: none"> a. Banks; b. Registered investment houses; c. Insurance companies; d. Pension funds or retirement plans maintained by the Government of the Philippines or any of its political subdivisions, or managed by a bank or other persons authorized by the Bangko Sentral ng Pilipinas to engage in trust functions; e. Investment companies; or f. Other persons as the SEC may determine, by rule, as qualified buyers on the basis of financial sophistication, net worth, knowledge and experience in financial and business matters, or amount of assets under management. <p>Exempt Transactions Requiring Notice: Notice of exemption on SEC Form 10-1 shall be required in an offering or distribution of securities under section 10.1(k) and (L) of the SRC.</p>	
Singapore	<p>In Singapore, a public offer of bonds must be accompanied by a prospectus that is lodged with and registered by the Monetary Authority of Singapore (MAS), unless an exemption applies.</p> <p>The exemptions to the prospectus requirements include exemptions for offers that are made only to institutional investors and accredited investors, and personal offers where the total amount raised within any 12-month period does not exceed USD5 million.</p> <p>Definition of Accredited Investor and Institutional Investor:</p> <p>1. Accredited investor: Under section 4A: Specific classes of investors of the <i>Securities and Futures Act (SFA)</i> (Chapter 289), an “accredited investor” is defined as:</p> <ul style="list-style-type: none"> a. an individual whose net personal assets exceed SGD2 million, or whose income in the preceding 12 months is not less than SGD300,000; b. a corporation with net assets exceeding SGD10 million in value as determined by the most recent audited balance sheet of the corporation, or where the corporation is not required to prepare audited account regularly, a balance sheet of the corporation certified by the corporation as giving a true and fair view of the state of affairs of the corporation; c. the trustee of a trust; or d. Such other person as the Authority may prescribe. <p>2. Institutional investor: Under section 4A: Specific classes of investors of the SFA, “Institutional investor” is defined as:</p> <ul style="list-style-type: none"> a. a bank that is licensed under the Banking Act; b. a merchant bank that is approved as a financial institution under section 28 of the <i>Monetary Authority of Singapore Act</i>; c. a finance company that is licensed under the <i>Finance Companies Act</i>; d. a company or society registered under the <i>Insurance Act as an insurer</i>; e. a company licensed under the Trust Companies Act; f. the Government; 	

continued on next page

Table 22. continuation

Jurisdiction	Concept and Definition of Professional or Institutional investors	Remarks
	<ul style="list-style-type: none"> g. a statutory body; h. a pension fund or collective investment scheme; i. the holder of a capital markets services license for dealing in securities, fund management, providing custodial services for securities, real estate investment trust management, securities financing, or trading in futures contracts; j. a person (other than an individual) who carries on the business of dealing in bonds with accredited investors or expert investors k. the trustee of a trust; or l. Such other person as the MAS may prescribe. 	
Thailand	<p>There is no defined concept of professionals; it can be assumed that wholesale institutional investors represent the professionals. There is a concept of institutional investors and high net worth investors in Thailand. Definition of Institutional Investors and high net worth investors are clearly defined in the Notification of the Securities and Exchange Commission No. KorChor.5/2552. These concepts are related to the rule of exemption of the full disclosure based regulations.</p> <p>1. “Institutional investors” means:</p> <ul style="list-style-type: none"> i. Commercial banks; ii. Finance companies; iii. Securities companies for management of proprietary portfolios or private funds or investment projects established under laws governing finance business, securities business and credit foncier business; iv. Credit foncier companies; v. Insurance companies; vi. Government units and state enterprises under laws governing budgetary procedures or any other juristic persons established under specific laws; vii. Bank of Thailand; viii. International financial institutions; ix. Financial Institutions Development Fund; x. Government Pension Fund; xi. Provident funds; xii. Mutual funds; xiii. Foreign investors with the same characteristics as investors under (1) to (12), mutatis mutandis; <p>2. “High net worth investors” means: Individual persons having THB40 million baht (about USD1.3 million) or more of assets, excluding liabilities of such persons; Juristic persons having THB200 million baht or more in assets as recorded in the latest audited financial statements.</p>	
Viet Nam	<p>Professional securities investors mean commercial banks, financial companies, financial leasing companies, insurance organizations and securities trading organizations. (Article 6. Definition of terms in the Securities Law 2006)</p>	
<p>^a The specified investors listed in (d.) above may opt out of the status as specified investors by an agreement with the financial instruments business operator, etc. Corporations and individuals that are not included in any one of (a.) to (d.) above may opt in by an agreement with the financial instruments business operator, etc. To become a specified investor, an individual is required to have net asset of JPY300 million yen or more, financial assets of JPY300 million or more, and an investment experience of at least 1 year. Source: ADB Consultants, based on research materials and market visit information.</p>		

XXIII. Definition of Public Offering (and Private Placement or Exempt Regime)

Table 23. Definition of Public Offering (and Private Placement or Exempt Regime)

Jurisdiction	Details of Public Offering (and Private Placement)
People's Republic of China (PRC)	<p>The “Self-regulatory Rules for Inter-bank Bond Market Non-financial Enterprise Debt Instrument on Private Placement” provides for the entire process involved in private placement instruments including issuance, registration, trading, and information disclosure, among others. Exempt Regime is not applied in PRC.</p> <p>In the Inter-bank Bond Market, there are mainly two ways to issue bonds: public offering and negotiating issuance for targeted investors.</p> <p>Public offering: In the public offering bond market of the PRC, the bonds can be issued in two ways: Issue by tender (public tender) through the issue system of the People's Bank of China and book building. Non-financial enterprises that satisfy the relevant provisions of <i>Circular of the People's Bank of China (Financial Market Department) on Matters Concerning the Issue of Bonds by Tender through the Issue System of the People's Bank of China (BSC [2011] No. 11)</i> can also issue the bond by public tender.</p> <p>Negotiating Issuance - Private placement with targeted investors: (Generally speaking Private placement related disclosure rules are sometimes different from the public placement based disclosure rules).</p>

continued on next page

Table 23. continuation

Jurisdiction	Details of Public Offering (and Private Placement)
	<p>Issuers negotiate with underwriters on issuance conditions of bonds, subscription costs and bondholders responsibilities such as coupon rate, price, tenor, interest payment, amount and payment date, and sign an underwriter agreement. This type of issuance considers market factors and can therefore better reflect the market conditions. This type of issuance is an effective supplement of market-oriented bond issuance based on the market's demand. Under this method, based on the needs of the market, the issuing body will make decision in consultation with the bond subscription coupon bonds, price, term, interest-bearing manner, amount, payment date, subscription conditions, subscription costs and obligations of the Purchaser. Therefore the issuance with this method will better reflect needs of particular investors rather than prevailing market conditions. The market-oriented ways of issuing bonds is an effective supplement method.</p>
Hong Kong, China	<p>Methods of issuing Corporate Bonds: Private entities generally adopt one of the following methods to issue corporate bonds:</p> <ol style="list-style-type: none"> Public offering for bonds intended to sell to the public; or Private placement for bonds intended to sell to a small group of investors. <p>There are some differences in the requirements for the two methods. For instance, a more comprehensive and detailed prospectus is generally required for public offer whereas a relatively simple form of offer document or term sheet suffices for private placement. For details, refer to Part 2 of the Companies Ordinance. For bonds to be listed on the Hong Kong Stock Exchange (HKSE), corporates should also observe the requirements of the Listing Rules, as well as Parts II and XII of the CO including section 44B.</p>
Indonesia	<p>a. Exemptions for Private Issuance (Private Placement): A securities offering that does not meet the criteria for public offering (so-called private placement) is exempted from the obligation to submit Registration Statements to Bapepam-LK, and thus exempted from all offering requirements under Bapepam-LK rules. The criteria for public offering, which is offered within the jurisdiction of Indonesia, or offered to Indonesian citizens through mass media, or offered to more than 100 parties or sold to more than 50 parties in a certain limited amount at a certain time, is covered under article 1, No. 1a.15 of the Elucidation of the <i>Capital Market Law</i>.</p> <p>A Sustainable Public Offering (so-called Shelf Registration) is an initial public offering (IPO) for debit securities instrument (EBU) and/or <i>Sukuk</i> which are effected sustainably as regulated in <i>Peraturan Bapepam dan LK Nomor IX.A.15 tentang Penawaran Umum Berkelanjutan</i>. Sustainable Public Offering (Shelf Registration) is chosen in order to provide convenience for the issuer or public company with good performance to facilitate the IPO of EBU and/or <i>Sukuk</i> on a regular basis. Sustainable Public Offering should be implemented no longer than 2 years since the effectiveness of Registration Statement with certain criteria for both the issuer and securities.</p> <p>There is a Private Placement Market for medium-term notes (MTNs) and corporate bonds which could be registered by the central securities depository, Indonesian Central Securities Depository. The Indonesian regulatory framework does not specifically address the registration of MTN, but it regulates the registration procedures for bonds and <i>Sukuk</i>. In order to facilitate the issuance of MTN, which allows a firm to issue a series of bonds within a particular period with only one registration statement submission, Bapepam-LK released a new regulation on shelf-registration. Under the current regulatory arrangement, if bond issuance by non-residents is publicly offered, it must follow the procedures similar to the issuance by domestic firms, without any exception. This may hinder foreign issuers due to especially the requirements on domestic supporting professionals.</p>
Japan	<p>A public offering is generally subject to requirements to disclose the solicitation documents stipulated in the Financial Instruments and Exchange Act (FIEA), whereas a private placement (PP) is not. Disclosure requirements by way of filing a Securities Registration Statement and delivering a Prospectus under the FIEA and a related Order for Enforcement and Cabinet Office Ordinances are applicable to the solicitation of the public, i.e., public offering, for either an initial issue or sale of existing securities. The following categories are not deemed to be a public offering: (a) to a small number of investors (small number-private placement is a private placement to less than 50 people.) or (b) to qualified institutional investors (the QII-PP) or (c) to specified investors (the Offer to Specified Investor).</p>
Republic of Korea	<p>Public offerings generally refer to actions with the aim of selling to multiple ordinary investors. The Financial Investment Service and Capital Market Act (FSCMA) define a public offering as public offering and public sale. The term "public sale" in the FSCMA refers to gathering 50 or more investors, as calculated by a formula prescribed by Presidential Decree and FSC Regulation (Regulation on Issuance, Public Disclosure, etc. of Securities), to make an offer to sell or invite offers to purchase securities already issued (FSCMA Article 9[9]).</p> <p>In other words this means soliciting 50 or more investors (the sum of those who have received recommendations) that have not made, applied to, or bought the same type of securities as the relevant securities being offered within 6 months of the day offers to buy are made.</p>
Malaysia	<p>The Securities Commission (SC) and Bank Negara Malaysia introduced an 'exempt regime', reducing onerous listing requirements, including possibly fee waivers; this is most used for <i>Sukuk</i> listings.</p> <ul style="list-style-type: none"> • In addition to AAA (local rating) exemption, an international rating BBB+ or better may also qualify issuer for disclosure exemption. • CMSA Schedules 6 and 7 regulate exemptions of disclosure, such as professional (here: 'sophisticated investors'), including insurance companies and high net worth individuals; details are available on the SC website.

continued on next page

Table 23. continuation

Jurisdiction	Details of Public Offering (and Private Placement)
Philippines	<ul style="list-style-type: none"> • Differentiation of public or private placement: >19 investors, historic driver, possibly because of taxation issue • All issues require 'Registration Statement' to the Securities and Exchange Commission (SEC), constitutes basic disclosure exemptions are granted for securities issued only to primary institutional lenders or qualified buyers as defined in the Securities Regulation Code (SRC) sections 9 and 10, and the SRC Implementing Rules and Regulations. • Exempt issues are defined in SRC section 9; exempt securities are defined in SRC section 10; section 10k mentions distinction of <19 investors; 10l mentions 'Qualified Institutional Buyer' (QIB) concept; the criteria for institutional versus individual professional investors was laid out (added) by SEC in 2007 • No onward sale of section 10 securities to non-QIB.
Singapore	<p>Public offering is the selling of registered securities to the broad market, rather than to a select group of investors. In Singapore, a public offer of bonds must be accompanied by a prospectus that is lodged with and registered by the Monetary Authority of Singapore (MAS), unless an exemption applies.</p> <p>Strictly speaking, the Bill removed the concept of "offer to the public" from the <i>Securities and Futures Act</i> (SFA). Instead, a prospectus will be required for all offers of investments unless they are specifically exempted. As a basic principle, such exemptions should only be given in limited circumstances where the cost of issuing a prospectus is not justified by the benefits of greater disclosure and investor protection.</p> <p>The exemptions to the prospectus requirements include exemptions for offers that are made only to institutional investors and accredited investors, and personal offers where the total amount raised within any 12-month period does not exceed USD5 million. Issuers of bonds that are offered to retail investors would normally seek a listing of these bonds on the Singapore Exchange and the bonds are normally in small denomination. Notices of bond offerings by statutory boards, domestic and foreign issuers are generally published in the newspapers or on the issuer's website. They outline issuance details such as auction dates, size and type of issue. General public offerings can be accessed through a prospectus database available at the MAS website under the Offers and Prospectuses Electronic Repository and Access tab.</p> <p>Brief Summary of the Exemptions from Prospectus Requirements</p> <ol style="list-style-type: none"> a. Offers those are made to institutional investors or accredited investors and are not accompanied by public advertisements. (SFA 274+275) b. Private placement offers made to no more than 50 persons (See above private placement) (SFA 272B, etc.) c. An entity whose shares are already listed on the SGX may use an Offer Information Statement (OIS), instead of a prospectus, when issuing new types of securities such as bonds. An OIS has fewer disclosure requirements. d. Institutions offering continuously issued structured notes do not need to lodge and register a pricing statement with the MAS; the base prospectus and a transaction note, setting out the offer details prior to the purchase or subscription and a confirmation receipt thereafter, to the investors at the time of offer are sufficient. e. Small Offer: the total amount raised by the person from such offers within any period of 12 months does not exceed USD5 million (or its equivalent in a foreign currency), etc. (SFA 272 etc.) <p>Private placement is the selling of unregistered securities directly, where offer is made to not more than 50 investors within a 12-month period.</p> <p>Private bond placements sometimes are not listed on a stock exchange. An issuer who offered the bonds through private placement can still seek a listing on SGX.</p> <p>Many of primary issuance is made in the form of private placement offers.</p> <p>Many Singapore dollar corporate bonds are placed privately at the issuer's or investor's (reverse enquiry) initiative.</p>
Thailand	<ol style="list-style-type: none"> 1. The bond can be offered for sale by way of Public Offering (PO) or Private Placement (PP). PP generally means to offer for sale to institutional investors (II), high net worth investors (HNWI) and specific investors. 2. Approval from the Securities and Exchange Commission (SEC) is required for the offer for sale by way of a Public Offering. A full filing form (a specific form prescribed by the SEC) and draft prospectus have to be submitted to the SEC. 3. PP (Narrow Distribution less than 10 people or Small Size) is exempt from filing requirement. 4. PP (II&HNWI) is exempt from full filing requirement. (Light requirement remains) 5. The concept of II or Qualified Foreign Institutional Investor (QFII) does not only apply to securities available for sale in the Exchange Market but also applies to debentures issued by way of private placement. 6. A credit rating is also required for an offer for sale by way of a PO and PP. 7. The newly issued bond must be registered with the Thai Bond Market Association. 8. A bond representative is needed for an offer for sale by way of a PO. 9. An annual report is required to be filed with the SEC.
Viet Nam	<p>Public offering means an offering of securities according through one of the following methods:</p> <ol style="list-style-type: none"> (a) Via mass media, including Internet; (b) Offering of securities to 100 investors or more, excluding professional investors; (c) Offering to an unspecified number of investors. <p>Non-public offering (PP) of securities means an organization offers securities to less than 100 investors, not including professional security investors and not using mass media or the Internet.</p>

Source: ADB Consultants, based on research materials and market visit information.

XXIV. Existence of Professional Investors-Only Market

Table 24. Existence of Professional Investors-Only Market

Jurisdiction	Status Quo of the Professional Investors-Only Market
People's Republic of China	Does not exist. Inter-bank Bond Market is a non-retail market, but that does not mean that it is a professional market.
Hong Kong, China	The Hong Kong Exchanges and Clearing Limited has performed market consultation on some proposed changes to the requirements for the listing of debt issues to professional investors only in December 2010 and the Rule amendments were effected in November 2011.
Indonesia	Does not exist.
Japan	TOKYO PRO-BOND market with listing on the TOKYO AIM. Offerees are limited to Specified Investors (the Offer to SI). This is a new market which is exempted from full disclosure requirements for public offerings.
Republic of Korea	The Qualified Institutional Buyer (QIB) market and trading system will be launched in 2012.
Malaysia	The Securities Commission and Bank Negara Malaysia introduced the ' exempt regime ', reducing onerous listing requirements, including possibly fee waivers; this is most used for <i>Sukuk</i> listings. <ul style="list-style-type: none"> • In addition to AAA (local rating) exemption, an international rating BBB+ or better may also qualify issuer for disclosure exemption. • Capital Market and Services Act 2007 Schedules 6 and 7 regulate exemptions of disclosure, such as professional (here: 'sophisticated investors'), including insurance companies and high net worth individuals.
Philippines	Exemptions are granted for securities issued only to primary institutional lenders or qualified buyers as defined in the Securities Regulation Code (SRC) sections 9 and 10, and the SRC Implementing Rules and Regulations.
Singapore	There is a market which is exempted from Prospectus Requirements : <ol style="list-style-type: none"> Offers are made to institutional investors or accredited investors and are not accompanied by public advertisements. (Securities and Futures Act [SFA] 274+275) Private placement offers made to no more than 50 persons (See above private placement) (SFA 272B etc.) An entity whose shares are already listed on the Singapore Exchange may use an Offer Information Statement (OIS), instead of a prospectus, when issuing new types of securities, such as bonds. An OIS has fewer disclosure requirements. Institutions offering continuously issued structured notes do not need to lodge and register a pricing statement with the Monetary Authority of Singapore; the base prospectus and a transaction note, setting out the offer details prior to the purchase or subscription and a confirmation receipt thereafter to the investors at the time of offer are sufficient. Small Offer: the total amount raised by the person from such offers within any period of 12 months does not exceed SGD5 million (or its equivalent in a foreign currency), etc. (SFA272 etc.)
Thailand	Does not exist explicitly. But, Private Placement (PP) is exempt from full filing requirement. <ol style="list-style-type: none"> Private Placement (PP) generally means to offer for sale to institutional investors (II), high net worth investors (HNWI), and specific investors. Approval from the Securities and Exchange Commission (SEC) is required for the offer for sale by way of a Public Offering (PO). A full filing form (a specific form prescribed by the SEC) and draft prospectus have to be submitted to the SEC. PP (Narrow Distribution less than 10 persons or Small Size) is exempt from filing requirement. PP (II&HNWI) is exempt from full filing requirement. (Light requirement remains) The concept of II or Qualified Foreign Institutional Investor (QFII) does not only apply to securities available for sale in the Exchange Market but also applies to debentures issued by way of private placement. A credit rating is also required for an offer for sale by way of a PO and PP. The newly issued bond must be registered with the Thai Bond Market Association. A bond representative is needed for an offer for sale by way of a PO. Not necessary for PP. An annual report is required to be filed with the SEC.
Viet Nam	Does not exist. But, there is so far a concept of the institutional investors. <ol style="list-style-type: none"> Item 11, article 6 of <i>Securities Law No. 70/2006/QH11</i> defines "institutional investors [as] commercial banks, financial companies, financial leasing companies, insurance organizations and securities trading organizations." Not clear about the concepts of wholesale and retail in this market. Private placement (non-public offering) concept is not clearly defined in the laws and regulations in Viet Nam. Private placement (non-public offering) is not regulated in Viet Nam.

Source: ADB Consultants, based on research materials and market visit information.

XXV. Market Capitalization – Size of the Local Currency Bond Market (as of March 2011)

Table 25. Market Capitalization – Size of Local Currency Bond Market (as of March 2011) (\$ billion)

Jurisdiction	Government	Corporate	Total
People's Republic of China	2,369.8	696.4	3,066.2
Hong Kong, China	87.6	78.7	166.3
Indonesia	103.9	13.9	117.8
Japan	10,425.5	1,087.3	11,512.8
Republic of Korea	524.3	687.2	1,211.5
Malaysia	160.6	108.4	269.0
Philippines	63.6	9.4	73.0
Singapore	105.7	84.9	190.6
Thailand	180.9	44.1	225.0
Viet Nam	14.2	1.4	15.6

Source: AsianBondsOnline.

XXVI. Size of Foreign Currency Bond Market (as of March 2011)

Table 26. Size of Foreign Currency Bond Market (as of March 2011) (\$ billion)

Jurisdiction	Government	Corporate	Total
People's Republic of China	13.0	58.7	71.7
Hong Kong, China	1.6	70.8	72.4
Indonesia	18.0	17.3	35.3
Japan	33.6	78.2	111.8
Republic of Korea	21.7	110.7	132.4
Malaysia	3.0	22.2	25.2
Philippines	34.1	7.3	41.4
Singapore	0.0	36.4	36.4
Thailand	1.4	6.7	8.1
Viet Nam	2.3	0.1	2.4
Total	128.7	408.4	537.1

Source: AsianBondsOnline.

XXVII. Islamic Finance related Issues

Table 27. Islamic Finance-Related Issues

Jurisdiction	Existence of the Islamic Finance Market	Explanation
People's Republic of China	No	
Hong Kong, China	Yes	<ol style="list-style-type: none"> 1. Regulatory framework for Islamic Finance: Save for the relevant laws relating to tax issues, the regulatory and legal framework for Islamic finance largely follows the one applicable to conventional debt instruments. 2. Type of instruments available, segments, tenure, etc.: Though the market infrastructure, regulatory and legal framework is in place, the market remains inactive for the time being probably due to the tax issues.

continued on next page

Table 27. continuation

Jurisdiction	Existence of the Islamic Finance Market	Explanation
		<p>3. Basic market infrastructure required to facilitate Islamic Finance: Enhancements have been made to US dollar and euro real-time gross settlement systems as well as Central Moneymarkets Unit (CMU) in Hong Kong to facilitate participating members to identify transactions related to Islamic finance and to segregate Islamic-related funds from others.</p> <p>4. Tax-related issues: The key tax issue relating to Islamic bonds is that the arrangement operates in the form of equity finance but is in substance similar to debt finance. In Hong Kong, tax law treats debt and equity differently. For instance, interest income and interest expenses arising from a debt finance arrangement may be taxable and deductible subject to certain conditions. In contrast, dividend income and distributions arising from an equity finance arrangement are generally not taxable or deductible. As a result of the heavier tax burden, issuing and/or investing in Islamic bond may be less favorable than issuing and/or investing in conventional debt instruments. The Government is studying how to take forward amendments to the relevant laws to facilitate development of a local Islamic bond market by leveling the playing field for Islamic bonds vis-à-vis their conventional counterparts as far as tax arrangements are concerned.</p>
Indonesia	Yes	<p>According to Bapepam-LK Rule No IX.A.13 concerning Issuance of Shari'a Securities, <i>Sukuk</i> are Shari'a Securities in a form of certificate or proof of ownership which have the same value and represent a participation unit which is not separated from or consists of underlying assets.</p> <p>A. Islamic bonds (<i>Sukuk</i>) in Indonesia have had the following fatwa and legal basis:</p> <ol style="list-style-type: none"> 1. <i>Fatwa No. 32/DSN-MUI/IX/2002</i> concerning Shari'a Bonds 2. <i>Fatwa No. 33/DSN-MUI/IX/2002</i> concerning Shari'a Mudharabah Bonds 3. <i>Fatwa No. 40/DSN-MUI/IX/2003</i> concerning the Capital Market and the General Guidelines for Implementation of Shari'a in the Capital Market 4. <i>Fatwa No. 41/DSN-MUI/III/2004</i> concerning Shari'a Ijarah Bonds 5. <i>Fatwa No. 59/DSN-MUI/V/2007</i> concerning conversion of Shari'a Mudharabah Bonds 6. <i>Fatwa No. 69/DSN-MUI/VI/2008</i> concerning of the Government Shari'a Securities (Surat Berhaga Syariah Negara, SBSN) 7. <i>Fatwa No. 70/DSN-MUI/VI/2008</i> concerning the method of SBSN Issuance 8. <i>Fatwa No. 71/DSN-MUI/VI/2008</i> concerning of Sale and Lease Back of <i>Ijarah</i> SBSN 9. <i>Fatwa No. 69/DSN-MUI/VI/2008</i> concerning SBSN <i>Ijarah</i> Sale and Lease Back <p>B. Government <i>Sukuk</i>:</p> <p>Domestic Issuance:</p> <ol style="list-style-type: none"> 1. Book Building (<i>Finance Minister Regulation No. 118/PMK.08/2008</i> regarding Domestic <i>Sukuk</i> Issuance In Primary Market Through Bookbuilding); 2. Auction (<i>Finance Minister Regulation No. 11/PMK.08/2009</i> regarding Government <i>Sukuk</i> Auction In Primary Market); 3. Book Building (<i>Finance Minister Regulation No. 218/PMK.08/2008</i> regarding Retail <i>Sukuk</i> In Primary Market); Changes: No. 10/Pmk.08/2007; 172/Pmk.08/2010; 4. Private Placement (<i>Finance Minister Regulation No. 75/PMK.08/2009</i> regarding Government <i>Sukuk</i> Private Placement Issuance) <p>International Issuance:</p> <ol style="list-style-type: none"> 1. Book Building/Public Offering <i>Finance Minister Regulation No. 152 /PMK.08/2008</i> regarding Foreign-Denominated <i>Sukuk</i> Issuance In International Market; the changes: No. 129/PMK.08/2009; 2. Private Placement (<i>Finance Minister Regulation No. 75/PMK.08/2009</i> regarding Government <i>Sukuk</i> Private Placement Issuance).
Japan	Yes	<p>Japan has strong economic ties with Islamic countries, which are demonstrated by huge cash outflow from Japan to those countries every year. Facilitating the reverse flow of investment from Islamic countries towards Japan and other Asian regions is very meaningful for a balanced growth of the global economy, particularly in the age of a high oil price. In 2007, a number of Japanese public and private institutions started to explore Islamic finance as one of the means to attract Islamic investors to invest in Japan by participating in the Islamic Financial Services Board (IFSB), an international standard-setting organization for the Islamic finance services industry headquartered in Malaysia, as observer.</p>

continued on next page

Table 27 continuation

Jurisdiction	Existence of the Islamic Finance Market	Explanation
		For the time being, Japan is not equipped with a full-ranged regulatory framework for operating Islamic Finance. However, in December 2008, the Japanese banking and insurance business regulation was relaxed to allow subsidiaries of Japanese banks and insurance companies to provide certain Islamic Finance services in such forms as <i>Murabahah</i> (cost-plus sale) or <i>Ijarah</i> (leasing) by amending the Ordinance for Enforcement of the <i>Banking Law and the Insurance Business Law</i> . At present, there are a few cases where subsidiaries of Japanese banks are applying for the regulatory authorization required for conducting Islamic financial operations overseas. Issues of Shari'a compliance, or that of supervision of the market, have not yet been taken up for discussion in Japan. In 2010, further steps were contemplated to facilitate <i>Sukuk</i> issuance by Japanese domestic corporations (or other public or quasi-public entities) under the Japanese legal system. Since the latter half of 2010, the momentum within the Japan Financial Services Agency accelerated. The National Diet passed a bill on 17 May 2011 to facilitate <i>Sukuk</i> issuance in Japan by amending the <i>Asset Securitization Act</i> . The bill is accompanied by amendments on relevant tax legislation with a view to creating a level tax playing field compared to conventional bonds.
Republic of Korea	No	
Malaysia	Yes	The Malaysian <i>Sukuk</i> market has shown remarkable progress since its introduction in 1990. Malaysia has successfully created a niche market in this area. It is estimated that from January to September 2011, based on Islamic Finance Information Service, 70% of the total global Islamic bonds that have been issued were issued in Malaysia, making Malaysia one of the world's largest <i>Sukuk</i> markets. In 2010, <i>Sukuk</i> issuance amounted to MYR 30 billion, accounting for 56% of total <i>Sukuk</i> issuance. In 2009 and 2010, <i>Sukuk</i> were extremely popular with issuers and investors alike, eclipsing conventional bonds and accounting in both years for more than 50% of issuance. Demand for Islamic paper by Islamic and conventional investors was strong, and major issuers, in particular the toll road concessionaires and power supply companies, took advantage of lower issuance costs as the demand led to more competitive bidding. Issuers are no longer constrained by the legal concept of debentures (debt-based), as required for conventional products, following the implementation of the latest <i>Sukuk</i> Guidelines made effective by the Securities Commission in August 2011.
Philippines	No	
Singapore	Yes	In 2005, Singapore was accepted as a full member of the IFSB, an international body based in Malaysia that defines regulatory and supervisory standards governing Islamic financial services. In January 2009, Singapore launched its first Islamic bond program worth SGD200 million.
Thailand	Yes	Thailand is at the early stage of developing an Islamic bond market. The specific regulations for issuance and offering of <i>Sukuk</i> were only announced in early January 2011. The regulatory framework falls under the Securities and Exchange Commission Act and Trust for Transactions in Capital Market Act, respectively.
Viet Nam	No	

Source: ADB Consultants, based on research materials and market visit information.

Appendix

Items to be included in the SF1 Market Guides for the region

Points for comparative analysis based on the questionnaire.

1. Governing Law for Corporate Bonds Issuance
2. Definition of Securities (Bonds)
3. Competent Authority (Regulator)
4. Issuing Approval Method
5. Role of the SROs
6. Purpose of the Listing of Bonds (e.g., profiling or real listing)
7. Obligation for the Listing of Bond
8. Main Trading Places (Over the Counter or Exchange)
9. Necessity of the Credit Rating
10. Method of Registration of Bonds
11. Status of the Bonds (Bearer or Registered)
12. Form of the Bonds (Scripless or Physical)
13. Status of the Scripless Bonds (Complete Dematerialized or Immobilized)
14. Existence of the exchangeability of the Scripless Bond to the Physical Bonds
15. Method of Transfer of Interest in Bonds
16. Finality of Settlement
17. Legal Basis and Definition of “Settlement and Clearing”
18. Existence of the Omnibus Accounts
19. Existence of the Nominee Concept
20. Regulators’ Policy related to the necessity of Disclosure of Ultimate Beneficially Owner
21. Documentation Language
22. Definition of the Payment Default
23. Bankruptcy Procedures
24. Existence of the Meeting of Bondholders
25. The Way of Trustee (Bond Representative or Commissioned Persons) System
26. The definition of Professional or Institutional Investors
27. Public Offering Market (Full Disclosure) Rules and Regulation
28. Private Placement Rules and Definition of Professional (Institutional) Investor and High Net Worth Investors (HNWI)
29. Islamic Finance-Related Issues

Reference

Contact (ADB Consultant, Principal Author):

Prof. Shigehito Inukai
Faculty of Law, Waseda University
1-6-1, Nishiwaseda, Shinjuku-ku, Tokyo, 169-8050
Tel & Fax (Direct): + 81-(0)3-3202-2472
Mobile: +81-(0)80-3360-7551
E-Mail: shige.inukai@me.com

Part 2

Bond Market Guides in 11 Economies

Section 1: People's Republic of China

Section 2: Hong Kong, China

Section 3: Indonesia

Section 4: Japan

Section 5: Republic of Korea

Section 6: Lao PDR

Section 7: Malaysia

Section 8: Philippines

Section 9: Singapore

Section 10: Thailand

Section 11: Viet Nam

People's Republic of China Bond Market Guide

Contents

Acknowledgement	v
I. Structure, Type, and Characteristics of the Bond Market.....	1
A. Breakdown and Segmentation of the Market	1
B. Methods of Issuing Bonds.....	2
C. Credit Rating System	2
D. Related Systems for Investor Protections (Trustee System)	3
E. Listing of Bonds and Medium-Term Notes	4
F. Legal and Regulatory Framework of the Bond Market.....	4
G. Laws on Bonds Issuance	6
H. Self-Governing Rules of the Market.....	6
I. Bankruptcy Procedures	7
II. Primary and Secondary Market-Related Regulatory Frameworks	8
A. Provisions Regarding Bonds Issuance	8
B. Provisions Regarding Investors	9
C. Taxation Framework and Requirements.....	10
D. Regulatory Reporting Requirements	11
E. Possible Challenges and Expected Changes of Regulatory Rules	12
III. Trading of Bonds and Trading Market Infrastructure	14
A. Trading of Bonds	14
IV. Impediments/Restrictions for the Realization of a Cross-Border Inter-Regional Market	17
A. Issues Concerning Accounting Standards	17
B. Issues Concerning Information Disclosure and Investors' Protection	18
V. Description of the Securities Settlement System	19
A. The Custody System.....	19
B. The Securities Settlement Infrastructures	19
C. The Bond Transaction Flows	21

VI. Costs and Charging Methods	26
A. Charging Methods for Trading in China's Bond Market.....	26
B. Charging Methods for Clearing and Settlement.....	27
C. Charging Methods for Registration and Custody	27
VII. Market Size and Related Statistics	28
A. Issuance, Custody and Settlement in China's Inter-bank Bond Market	28
B. China's Financing Structure from 2005–2009.....	28
C. Depository Products on the Shanghai Clearing House	29
D. Exchange-Traded Bonds Transactions	29
VIII. Islamic Bond (Sukuk) Market	30
IX. Direction of Future Development	31

Figures and Tables

Figures

Figure 5.1	Bond Market Infrastructure Diagram.....	19
Figure 5.2	Bond Transaction Flow for Domestic Trades in the Over-the Counter Market/Delivery versus Payment.....	21
Figure 5.3	Bond Transaction Flow for Domestic Trades Exchange Market/Delivery versus Payment.....	22
Figure 5.4	Bond Transaction Flow for Foreign Investors Exchange Market/Qualified Foreign Institutional Investors	24

Tables

Table 1.1	Credit Rating Ranks for Medium- and Long-Term Bonds in China's Inter-bank Bond Market	3
Table 1.2	Credit Rating Ranks for Short-Term Bonds in the Inter-bank Bond Market.....	3
Table 1.3	Major Provisions of Various Laws on Bond Issuance	5
Table 2.1	Provisions Regarding Bonds Issuance	8
Table 2.2	Tax Provisions for Qualified Domestic Institutional Investors and Qualified Foreign Institutional Investors	11
Table 3.1	Trading Volume in the Inter-bank Bond Market (¥ billion)	14
Table 5.1	Settlement Processing Overview Chart.....	20
Table 7.1	Issuance, Custody and Settlement in China's Inter-bank Bond Market, 5-Year Period Covered (¥ trillion)	28
Table 7.2	China's Financing Structure, 5-year Period Covered (¥ trillion and percentage)	28
Table 7.3	Statistics on Shanghai Clearing House Custody Products (As of 25 February 2011, Accumulative).....	29
Table 7.4a	General Information on Listed Bonds until February 2011.....	29
Table 7.4b	Bond Turnover of the Shanghai Stock Exchange (¥ billion)	29
Table 7.4c	Bond Turnover of the Shenzhen Stock Exchange (¥ billion)	29

Acknowledgement

The Asian Development Bank (ADB) Team, comprising Satoru Yamadera (Economist, ADB Office of Regional Economic Integration, - September 2011), Seung Jae Lee (Principal Financial Sector Specialist), Shinji Kawai (Senior Financial Sector Specialist, Banking), Shigehito Inukai (ADB consultant), Taiji Inui (ADB consultant), and Matthias Schmidt (ADB consultant), would like to express their sincere gratitude to National Members and Expert Institutions: The People's Bank of China, China Central Depository & Clearing (CDCC, or Chinabond) and the National Association for Financial Market Institutional Investors (NAFMII) for the Inter-Bank Bond Market, and the China Securities Depository and Clearing Corporation (CSDCC, or Chinaclear) for the exchange-traded bond market. They kindly provided answers to the questionnaires prepared by the ADB team, thoroughly reviewed the draft versions of the Market Guide, and gave their valuable comments for their respective market segments.

I. Structure, Type, and Characteristics of the Bond Market

A. Breakdown and Segmentation of the Market

People's Republic of China bond market is composed of both exchange and Inter-bank Bond Markets. These two markets complement, interconnect with, and complete each other. Both are integral parts of the Chinese financial markets as a whole.

The Inter-bank Bond Market is an over-the-counter (OTC) wholesale market, where market positioning of institutional investors and one-to-one quote-driven trading take place. In contrast, the exchange bond market is a retail market, in which individual and small- and medium-size institutional investors carry out trading through concentrated matchmaking method. Qualified Foreign Institutional Investors (QFII) are presently only permitted to access the exchange market.

The types of bonds available in China's bond market have become increasingly diversified. The initial bond categories of Treasury bonds and corporate bonds have evolved into a wide range of bond varieties. These include policy bank bonds, central bank bills, general financial bonds, subordinated bonds of commercial banks, hybrid capital bonds, super and short-term commercial papers, commercial papers, medium-term notes (MTNs), credit asset securitization products, listed companies bonds, local government bonds, international development institution bonds, and small- and medium-size enterprise (SMEs) collective notes, and private placement notes. In addition, bond provisions have become more flexible; some innovative varieties, such as embedded options and a clause of advance redemption have emerged.

Moreover, bond trading instruments have witnessed an evolution from spot trading and repurchase trading to bond forwards, forward rate agreement, Renminbi interest rate swap, bond lending, credit risk mitigation agreement, and credit risk mitigation warrant, among many others. Financial bonds may also now be publically issued in the national Inter-bank Bond Market or to targeted investors.

At present, there is no well-defined concept of professional investors in China. Nevertheless, majority of investors in the Inter-bank Bond Market are professional investment institutions.

B. Methods of Issuing Bonds

In China's bond market, bonds can be issued in two ways: by tender through the issue system of the People's Bank of China (PBOC) and by book building. Currently, Treasury bonds and policy bank bonds are issued by tender through PBOC's issue system. Credit products, on the other hand, are issued mostly through book building in the central book-entry system. With the rapid development of credit bonds since 2009, the market can substantially accept bonds with a relatively high credit rating.

Non-financial enterprises can also issue bonds by public tender, provided that they satisfy the relevant provisions of the *Notice of the People's Bank of China (Financial Market Department) on the Relevant Matters Concerning the Issue of Bonds by Tender through the Issue System of the People's Bank of China (BSC[2010] No. 11)*.¹

C. Credit Rating System

At present, there are eight major credit rating agencies in China's bond market. Two of these are Sino-foreign joint ventures; one is engaged in a technical cooperation with a foreign enterprise and the remaining five are domestic-funded agencies.

The PBOC serves as the main supervisory authority of the credit rating industry. As such, it is mainly responsible for drafting relevant rules and regulations governing the credit rating system (CRS), and drawing up development strategies and policies, among many others. The China Securities and Regulatory Commission (CSRC) supervises credit rating in the exchange bond market while the National Development and Reform Commission (NDRC) oversees the credit rating for enterprise bonds.

In November 2006, the PBOC released the *Specification for Credit Rating in the Credit Market and Inter-bank Bond Market*, which contained a unified definition for the classification, symbol, and meaning of the medium- and long-term, and short-term credit ratings in the Inter-bank Bond Market. Tables 1.1 and 1.2 show the credit rating ranks for medium- and long-term bonds, and short-term bonds in the Inter-bank Bond Market, respectively. The ranks of credit rating for medium- and long-term bonds are divided into nine levels in three classes, symbolically representing in AAA, AA, A, BBB, BB, B, CCC, CC and C. The credit rating ranks for short-term bonds in the Inter-bank Bond Market can be divided into six levels in four classes: A-1, A-2, A-3, B, C, and D. No slight adjustment can be made to each rank.

¹ PBOC Financial Market Department. Notice of the People's Bank of China (Financial Market Department) on the Relevant Matters Concerning the Issue of Bonds by Tender through the Issue System of the People's Bank of China, BSC [2010] No.11.

Table 1.1 Credit Rating Ranks for Medium- and Long-Term Bonds in China's Inter-bank Bond Market

Credit Rank	Meaning
AAA	Extremely strong capacity to pay the debt, free from influence of unfavorable economic environment, and extremely low default risk
AA	Very strong capacity to pay the debt, insignificantly affected by unfavorable economic environment, and very low default risk
A	Relatively strong capacity to pay the debt, relatively easy to be affected by unfavorable economic environment, and relatively low default risk
BBB	Moderate capacity to pay the debt, somewhat significantly affected by unfavorable economic environment, and moderate default risk
BB	Relatively weak capacity to pay the debt, significantly affected by unfavorable economic environment, and relatively high default risk
B	The capacity to pay the debt somewhat mainly depends on sound economic environment, and very high default risk
CCC	The capacity to pay the debt extremely depends on sound economic environment, and extremely high default risk
CC	Relatively weak protection in case of bankruptcy or reorganization, the capacity to pay the debt can hardly be guaranteed
C	Unable to pay the debt

Note: Except for AAA, CCC, and the ones below CCC, "+" or "-" can be used for each rank to address a slight adjustment, representing slightly higher or lower grade than that of the corresponding rank.
Source: The People's Bank of China (PBOC). 2006, *Specification for Credit Rating in the Credit Market and Inter-bank Bond Market*. Beijing, China.

Table 1.2 Credit Rating Ranks for Short-Term Bonds in the Inter-bank Bond Market

Credit Rank	Meaning
A-1	Strongest capacity to repay the loan and accrued interest, and with the highest security
A-2	Relatively strong capacity to repay the loan and accrued interest, and relatively high security
A-3	Moderate capacity to repay the loan and accrued interest, and security is vulnerable to unfavorable economic environment
B	Relatively weak capacity to repay the loan and accrued interest, and somewhat vulnerable to default risk
C	Very weak capacity to repay the loan and accrued interest, and relatively high default risk
D	Unable to repay the loan and accrued interest

Note: Slight adjustment to each rank is not allowed.
Source: The People's Bank of China (PBOC). 2006, *Specification for Credit Rating in the Credit Market and Inter-bank Bond Market*. Beijing, China.

D. Related Systems for Investor Protections (Trustee System)

The bond market in China has witnessed considerable improvement in the mechanism to protect investors' interests, as well as the enhancement of investor education. To foster the development of Inter-bank Bond Market, the PBOC established a set of market-restrictive and risk-sharing mechanisms, which specifies the obligation and responsibility of the various intermediate actors in China's bond market.² This is to ensure the proper sharing of risks among issuers, intermediaries, and investors.

The NDRC, on the other hand, emphasizes protecting the investors' interests, encourages and guides issuers and underwriters to explore the effective methods to increase credit. On the basis of a selective bond issuance program, the NDRC also rationalizes the scale to reduce risk, and introduced the concepts for bondholders meeting, debt proxy system, and mortgage assets supervisor system. It likewise requests issuers to formulate a practical and feasible debt repayment plan and safeguard measures, and guarantee the source of debt repayment.

² The intermediate actors in the China bond market include underwriters, accounting firms, law firms, credit rating agencies, as well as other intermediaries.

The CSRC, for its part, established the bonds classification management system, bond trustee system, and the bondholders meeting system. At the same time, it develops the listed corporate bond markets.

The National Association of Financial Market Institutional Investors (NAFMII) is vigorously promoting the investors' protection mechanism in the non-financial enterprise debt capital market. It formulated self-regulatory normative documents such as the self-regulatory rule on bondholder conference guidelines.³ The NAFMII document sets the clear conditions of the need to organize a bondholder conference and how should an issuer organize such a conference.

E. Listing of Bonds and Medium-Term Notes

Listing of bonds means that the stock exchange acknowledges and accepts certain types of bonds to be traded on the stock exchange market.

1. Listing of Corporate Bonds and Enterprise Bonds

There are currently no unified rules for the listing of bonds in China. The rules the Shanghai Stock Exchange and Shenzhen Stock Exchange set down separately contain similar contents.⁴ Both give clear provisions on listing conditions, application for listing, listing approval, information disclosure and sustaining obligations, as well as suspension of listing, resumption of listing, and terminating listing, among others.

2. Trading and Circulation of Medium-Term Notes

At present, medium-term notes (MTNs) are traded and circulated only in the OTC market, specifically the Inter-bank Bond Market, and are unavailable in the stock exchange market. According to Article 13 of the *Guidelines for Non-Financial Corporate Medium-Term Notes in the Inter-bank Bond Market*, MTNs can be circulated and transferred among institutional investors in the Inter-bank Bond Market on the working day following the registration date of claim and debt.

F. Legal and Regulatory Framework of the Bond Market

Laws and regulations governing the bond market can be classified into four layers: laws, statutes or market management rules, regulations and administrative measures, and normative issuances and self-regulatory rules.

1. Laws on the Bond Market

The fundamental layer of the bond market legal system regulates and ensures the effective operation of the market. Laws are formulated and approved mainly by the National People's Congress or its Standing Committee. The law of the People's Republic of China on the PBOC stipulates the responsibilities and functions of PBOC in supervising the interbank bond market. Laws formulated to standardize bond market entities include *Securities Laws of the People's Republic of China and Commercial*

³ NAFMII. 2010. *Rules for the Meetings of the Holders of Debt Financing Instruments of Non-financial Enterprises in the Inter-bank Bond Market*. Beijing. <http://www.nafmii.org.cn/Info/354967>

⁴ Shanghai Stock Exchange *Rules for Listing of Corporate Bonds (SZZZ [2009 No. 186])*; *Rules of Shenzhen Stock Exchange for Corporate Bond Listing (SZS [2009] No. 143)*.

Bank Law of the People's Republic of China.⁵ Laws on contract, negotiable Instruments and guarantee govern economic relations between market entities.

2. Statutes or Market Management Rules

Market management rules, which make up the second layer of the bond market legal framework, include the *Regulations on Corporation Debt Management (August 2, 1993)* and the *Interim Regulations on Administration of Futures Trading (May 17, 2002)*.

3. Regulations and Administrative Measures

The third layer of the bond market legal framework includes various regulations and administrative measures, formulated and issued mainly by regulatory departments of the financial markets. Such measures include *Interim Measures for the Administration of Derivative Product Transactions of Banking Financial Institutions (January 5, 2011)*; *Measures for the Administration on Issuing Renminbi Bonds by International Development Institutions*; and *Measures for the Administration of Bond Transactions in the National Inter-Bank Bond Market (April 30, 2000)*; *Measures for the Administration of the Issuance of Financial Bonds in the National Inter-bank Bond Market (April 22, 2005)*; *Measures for the Administration of the Issuance of Subordinated Bonds by Commercial Banks (June 17, 2004)*; and *Measures for the Administration of Short-term Financing Bonds (May 23, 2005)*.

4. Normative Issuances and Self-Regulatory Rules

The fourth layer is composed of normative documents and self-regulatory rules regarding specific market operation. These include *Rules for the Registration of Issuing Debt Financing Instrument in the Inter-Bank Bond Market by Non-Financial Enterprise and Self-regulatory Rules on Bond Trading in the Inter-Bank Bond Market*.

Table 1.3 Major Provisions of Various Laws on Bond Issuance

Category	Title of Governing Law
Treasury bonds	<i>Regulations on Treasury Bonds of the PBOC (Decree of the State Council [1992] No. 95)</i>
	<i>Measures for the Examination and Approval of the Membership of the Government Bond Underwriting Syndicates (Order 39 of Ministry of Finance [MOF] of the People's Republic of China, the PBOC, and CSRC)</i>
	<i>Circular on Printing and Distributing the Rules for the Issuance of Book-Entry Treasury Bonds by Tender in 2011 (CK [2011] No. 4)</i>
Financial bonds	<i>Administrative Rules for the Issuance of Financial Bonds in the National Inter-bank Bond Market (Order [2005] No. 1 of the PBOC), (全国银行间债券市场金融债券发行管理办法, 2005年1号令)</i>
	<i>Administrative Procedures for the Issuance of Financial Bonds in the National Inter-bank Bond Market (Announcement [2009] No. 6 of the PBOC), (全国银行间金融债券发行管理操作规程, 2009年6号公告)</i>
	<i>Measures for the Administration of the Issuance of Subordinated Bonds by Commercial Banks (Announcement [2004] No.4 of the PBOC and China Banking Regulatory Commission [CBRC]), (商业银行次级债券发行管理办法, 2004年4号公告)</i>
	<i>Announcement on Relevant Matters Concerning the Issuance of Hybrid Capital Bonds by Commercial Bank (Announcement [2006] No. 11 of the PBOC), (关于混合资本债券发行有关问题的通知, 2006年11号公告)</i>
	<i>Interim Measures for Administration of Issuing Renminbi Bonds by International Development Institutions (Announcement [2010] No.10 of the PBOC, MOF, NDRC, and CSRC)</i>
	<i>Interim Measures for the Administration of the Issuance of Renminbi Bonds in Hong Kong Special Administrative Region by Financial Institutions Within the Territory of China (Announcement [2007] No.12 of the PBOC and NDRC)</i>

continued on next page

⁵ *The Securities Law of the People's Republic of China* was promulgated on December 12, 1998 and revised on October 27, 2005. The *Commercial Bank Law of the People's Republic of China* was passed into law on May 5, 1995 and was revised also on October 27, 2005.

Table 1.3 continuation

Category	Title of Governing Law
Short-and super short-term commercial papers, MTNs ¹	<i>Measures for the Administration of Non-Financial Enterprise Debt Financing Instruments in the Inter-bank Bond Market (Order [2008] No. 1 of the PBOC)</i> ¹
	Auxiliary self-regulatory rules formulated by the NAFMII
Listed corporate bonds	Pilot Rules on the Issuance of Corporate Bonds (Order 49 of China Securities Regulatory Commission)
	Relevant rules issued by the stock exchanges: <i>Shanghai Stock Exchange Rules for Listing of Corporate Bonds (SZZZ [2009] No. 186)</i> ; <i>Rules of Shenzhen Stock Exchange for Corporate Bond Listing (SZS [2009] No. 143)</i>
Enterprise bonds	Regulations on Administration of Enterprise Bonds
	Circular of NDRC on Promoting the Development of Enterprise Bonds Market and Simplifying the Matters Relating to the Approval for Insurance (FGCJ Document [2008] No.7)
	Interim Measures for the Administration of Central Enterprise Bonds
Non-financial enterprise issuing debt instruments by private placement	Self-regulatory Rules for Inter-bank Bond Market Non-financial Enterprise Debt Instrument on Private Placement ¹

¹ The document provides for the whole process involved in private placement instruments including issuance, registration, trading, and information disclosure, among others.
Source: Websites of relevant regulatory authorities in China.

G. Laws on Bonds Issuance

Administration of bond issuance in China's bond market is governed by several statutes, categorized into Treasury bonds, financial bonds, non-financial enterprise debt-financing instruments (including super short-and short-term commercial paper, MTNs, and private placement notes), listed corporate bonds, enterprise bonds, and non-financial enterprises issuing debt instrument by private placement. These are summarized in Table 1.2.

H. Self-Governing Rules of the Market

In September 2007, NAFMII was officially established as the entity mainly responsible for the self-regulatory management of the OTC market. With the tenets of "self regulation, innovation and service", NAFMII is conducting self-regulation over China's Inter-bank Bond Market under the supervision and guidance of the PBOC. Experience in most recent years proves that NAFMII plays an important role in facilitating market expansion, and in guiding and regulating both the primary and secondary markets.

Following the formation of NAFMII, a series of rules and guidelines regarding issuance and underwriting, information disclosure, credit rating and market transaction of debt-financing instruments were established in succession. Also, the full-process monitoring, subsequent monitoring, and emergency management and response mechanism for registration and issuance were correspondingly established and improved. Risk inspection and pressure tests on issued debt-financing instruments are regularly conducted. Dynamic monitoring on subsequent information disclosure, implementation of commitments after bond issuance, and site inspections to the issuer are also carried out in different levels to prevent market risk substantially.

With the self-regulatory system for the primary market in place, debt-financing instruments of non-financial enterprises underwent rapid expansion, and market management has become increasingly standardized. In 2010, NAFMII facilitated the issuance of debt-financing instruments of non-financial enterprises in local currency that reached ¥1.3 trillion, accounting for 76% of the total amount raised by non-financial enterprises through the bond market during the whole year.

Secondly, the self-regulatory management system for the secondary market was formulated and trading activities in OTC market became standardized. In order to promote innovations and standardized development of bond derivatives, the *Guidelines on Internal Risk Management of Financial Derivatives Transactions in the Inter-bank Bond Market* and the *Guidelines on Credit Risk Mitigation Tools Pilot Business Projects* were promulgated. The *Master Agreement on Trading Financial Derivative Instruments in the Inter-bank Bond Market of China* (also known as NAFMII Master Agreement), which provided a unified and standard text for the OTC financial derivatives market in China was published and popularized. A set of self-regulatory normative documents like *Working Guidelines for Market Makers of the Inter-bank Bond Market* and the *Self-Regulatory Rules and Code of Conduct for Personnel Relating to the Trading* were formulated to strengthen self-regulatory management of bond trading behavior of member institutions; to regulate the practicing behavior of related trader; to maintain the legitimate competitive order of the market; and to promote a sound and standardized development of the market.

I. Bankruptcy Procedures

According to Article 7 (2) of the *Law of the People's Republic of China on Enterprise Bankruptcy*, the creditor shall be entitled to ask the debtor to declare bankruptcy.

II. Primary and Secondary Market-Related Regulatory Frameworks

A. Provisions Regarding Bonds Issuance

When issuing bonds, different provisions apply to different types of bonds with respect to information disclosure and credit rating. The specific provisions are summarized in Table 2.1 below.

Table 2.1 Provisions Regarding Bonds Issuance

Item	Treasury Bonds	Financial Bonds	SCP, CP, MTN	Listed Corporate Bonds	Enterprise Bonds
Competent Authority	The State Council, MOF, PBOC	PBOC	PBOC	CSRC	NDRC
Approval Method		Verification and approval system (核准制)	Registration system (注册制)	Verification and approval system (核准制)	Verification and approval system (核准制)
Issuance Method		Issued once in full amount or in installments under specified quotas	Registered once and can be issued in installments	Approved once and issued in installments	Issued once subject to the approved size
Information Disclosure	N/A	Prospectus, issuance notes, financial report, and audit report, etc.	Prospectus, issuance notes, financial report, and audit report, etc.	Prospectus, issuance notes, financial report, and audit report, etc.	Prospectus, issuance notes, financial report, and audit report, etc.
Credit Rating	N/A	Corporate credit rating, debt credit rating, and follow-up credit rating	Corporate credit rating, debt credit rating, and follow-up credit rating	Corporate credit rating, debt credit rating, and follow-up credit rating	Corporate credit rating, debt credit rating, and follow-up credit rating
Size of Fund Raised	The issuance size for each year is determined by the State Council and announced by the MOF	The amount of long-term subordinated bonds issued by national commercial banks cannot exceed 20% of its core capital, and no more than 30% by other commercial banks	The accumulated balance cannot exceed 40% of the net assets of the company	The accumulated balance cannot exceed 40% of the net assets of the company	Satisfying the approved size by the State Council, and the accumulated balance cannot exceed 40% of the net assets of the company
Purpose of Funds Raised	Arrangements made by the State Council	No specific provisions	The funds raised shall be invested in conformity with national industry policy, and can be used for the production and operation activities of enterprises. The purpose of funds raised needs to be clearly disclosed in the issuance document.	The funds raised shall be invested in conformity with national industry policy, and filing with the China Securities Regulatory Commission	The funds raised shall be invested in conformity with national industry policy

continued on next page

Table 2.1 continuation

Item	Treasury Bonds	Financial Bonds	SCP, CP, MTN	Listed Corporate Bonds	Enterprise Bonds
Determination of Issuing Rate	Tender issuance	Tender issuance or book building ^a	Tender Issuance or book building ^b	Determined through market inquiry by issuers and sponsors	Determined by the enterprise according to the actual market condition, but subject to the approval of the regulatory body
Bond Maturity	No restrictions	No restrictions	The maturity for SCP is no longer than 270 days, for CP no longer than 1 year, for MTN is usually no longer than 10 years.	No restrictions	No restrictions, normally long-term bonds with maturities longer than five years
Main Trading Places	Inter-bank Bond Market, exchange market, and counters in pilot commercial bank	Inter-bank Bond Market	Inter-bank Bond Market	Exchange market	Cross-market trading, but are mainly traded in the Inter-Bank Market
Registration and Settlement Institutions	CCDC and CSDCC	CCDC	CCDC/SHCH	CSDCC	CCDC and CSDCC

^a Financial bonds can be issued by normal commercial banks by tender through the *Issue System of the People's Bank of China*.
^b The issuing rates of SCP, CP, and MTN can also be determined through the *Issue System of the People's Bank of China*.
 CCDC = China Central Depository and Clearing Corporation Limited; CP = commercial paper; CSDCC = China Securities Depository and Clearing Corporation Limited; CSRC = China Securities Regulatory Commission; MOF = Ministry of Finance; MTN = medium-term notes; NDRC = National Development and Reform Commission; PBOC = The People's Bank of China
 Source: Zhong Lun Law Firm, Beijing Office.

B. Provisions Regarding Investors

1. General Rules and Regulations

According to the *Measures for the Administration of Bond Transactions in the National Inter-bank Bond Market* and related laws and regulations, financial institutions that intend to become a member of the inter-bank bond market shall put such intention on record with the PBOC. Financial institutions intending to become market makers shall make an application to the PBOC, as well. In addition, savings financial institutions may also apply for a role as settlement agent with the PBOC.

Non-financial institutional investors may entrust financial institutions that are qualified agencies for settlement in the inter-bank bond market to carry out bond trading on their behalf. Meanwhile, securities companies with asset management plans that want to engage in the securities asset management business in the Inter-bank Bond market shall have separate bond-trading accounts for each asset management plan. PBOC is responsible for regulating and supervising the OTC bond market. Under the guidance of PBOC, NAFMII has formulated a self-regulatory management system for the secondary market and self-regulatory normative to strengthen self-regulatory management of members when carrying out trading activities.⁶

In August 2010, the PBOC promulgated the *Circular on Matters Concerning Pilot Investment in the Inter-bank Bond Market with Renminbi by Three Types of Institutions Including Overseas Renminbi Participating Banks*. This allows foreign institutions to enter the inter-bank bond market on a pilot investment project and brings overseas institutional investors into the inter-bank bond market. The CSRC, for its part, formulated laws and regulations pertaining to the exchange bond market.

⁶ These normative documents include the *Working Guidelines for Market Makers of the Inter-bank Bond Market*, *Self-regulatory Rules for Bond Trading in the Inter-bank Bond Market*, and the *Rules for the Meetings of the Holders of Debt Financing Instruments of Non-financial Enterprises in the Inter-bank Bond Market*.

Another general governing law on investors is the *Securities Law of the People's Republic of China*. It states that any insider who has access to insider information, or has unlawfully obtained any insider information on securities trading, may not purchase or sell the securities of the relevant company. Such insiders also may not divulge such information, or advise any other person to purchase or sell such securities. Anyone is prohibited from manipulating the securities market in collusion or collaboration with others to manipulate the securities market. Furthermore, securities companies, as well as practitioners, are prohibited from committing any fraudulent act in the process of securities trading, which may harm the interests of their clients.

In accordance with the *Interim Measures for the Administration of Utilization of Insurance Funds* promulgated by China Insurance Regulatory Commission in July 2010, insurance group holding and insurance companies shall follow the required proportion when using insurance funds. The said requirement stipulates that the total book balance of a company investing in banks' demand deposits, government bonds, central bank bills, policy bank bonds, and money market funds shall be no less than 5% of the total assets of the company at the end of last quarter. Also, the total book balance investing in unsecured enterprise (corporate) bonds and debt financing instruments of non-financial enterprises shall be no more than 20% of the total assets at the end of last quarter.

2. Rules and Regulations on Dealers with Special Qualifications

According to rules and regulations such as the *Rules on Market Makers in the National Inter-bank Bond Market*, financial institutions can make applications to the PBOC should they want to commence business in bilateral quotation for bonds and thus become a market maker. Deals through market making can enjoy benefits such as lower trading and settlement costs. NAFMII, under the authorization of the PBOC, will evaluate the performance of a market maker.

The *Circular of the People's Bank of China on Issues Concern[ing] Application to Bond Settlement Agent Business* provides that savings financial institutions can make applications to the PBOC should they want to commence business as a bond settlement agent. Once the application has been approved, other market participants may entrust these companies to handle the opening and closing of bond custody accounts and settlements on their behalf.

C. Taxation Framework and Requirements

According to circulars issued by the State Administration of Taxation and the Ministry of Finance, the arrangements of business tax and income tax for both qualified domestic institutional investors (QDII) and qualified foreign institutional investors (QFII) are as follows:

Table 2.2 Tax Provisions for Qualified Domestic Institutional Investors and Qualified Foreign Institutional Investors

Income Type	Qualified Domestic Institutional Investors (QDII)				Qualified Foreign Institutional Investors (QFII)			
	Treasury Bond		Financial Bond and Corporate Bond		Treasury Bond		Financial Bond and Corporate Bond	
	Interest Income	Bid-Ask Spread	Interest Income	Bid-Ask Spread	Interest Income	Bid-ask Spread	Interest Income	Bid-Ask Spread
Business Tax	N/A	5%	N/A	5%	N/A	Tax-free	N/A	Tax-free
Income Tax	Tax-free	25%	25%	25%	10%	Tax-free	10%	Tax-free

Source: China Central Depository and Clearing, Co. Ltd.

D. Regulatory Reporting Requirements

1. Reporting of Bond Issuance Information

Pursuant to *Administrative Rules for the Issuance of Financial Bonds in the National Inter-Bank Bond Market*, issuers of financial bonds are obliged to disclose relevant information before bond issuance and within its duration. Information shall be disclosed through the websites Chinamoney.com.cn and Chinabond.com.cn.

When a major event that may affect an issuer's ability to fulfill its debt obligations occurs, the issuer shall, in the first instance, report to and make relevant disclosure in a way prescribed by the PBOC.

Before the retirement of financial bonds, issuers shall disclose through an annual report to investors before April 30 of each year. The report includes an account of the issuers' performance situation of the previous year, financial reports audited by certified public accountants, major lawsuits involved and other matters. Where a guarantor backs financial bonds, the issuers shall also disclose the guarantor's financial situation during the previous year in the annual report, along with the audited financial report, major lawsuits involved and other matters. Where the financial bonds are issued to targeted investors, the content and format of information disclosure shall be stipulated in the prospectus and the issuance instructions. The information shall be disclosed to investors of the financial bond.

According to *Measures for the Administration of Debt Financing Instruments of Non-Financial Enterprises in the Inter-Bank Bond Market and the Rules for Information Disclosure of Debt Financing Instruments of Non-Financial Enterprises in the Inter-Bank Bond Market*, an enterprise that issues debt financing instruments, shall disclose related information in the inter-Bank bond market. Information disclosure shall abide by the principles of honesty and credibility, and there shall be no falsified descriptions, misleading statements, or major omissions. Issuers of debt financing instruments of non-financial enterprises shall disclose information through the websites Chinamoney.com.cn and Chinabond.com.cn. Before the retirement of debt-financing instruments and for any major event that may affect the issuer's ability to fulfill its debt obligations, the issuer shall promptly make a disclosure to the market.

In accordance with the *Regulations on Administration of Enterprise Bonds* and the *Circular of National Development and Reform Commission on Pushing the Development of Enterprise Bonds Market and Simplifying the Matters Relating to the Approval for Insurance*, the application for a public issuance of enterprise bonds shall be truthful, accurate and complete. Any information that may have a major impact on investment decisions of investors shall be fully disclosed, and the issuers and all parties concerned shall bear corresponding liabilities.

According to the *Pilot Rules on the Issuance of Corporate Bonds*, issuers who apply for the issuance of listed corporate bonds shall ensure a truthful, accurate, complete and timely disclosure, or render relevant information. There shall be no falsified descriptions, misleading statements or major omissions.

2. Reporting of Bond Trading Information

According to the rules and regulations such as the *Measures for the Administration of Bond Transactions in the National Inter-Bank Bond Market* and the *Circular of the People's Bank of China on Issues Concerned in Application to Bond Settlement Agent Business*, market makers and settlement agencies shall regularly report business performance to the PBOC. Currently, there is no regulation that requires market makers and settlement agencies to furnish a copy of the report submitted to PBOC to intermediary platforms or self-regulatory bodies.

In addition, according to a requirement by PBOC, in the event that bonds are not traded through the trading system of CFETS, both parties should report the trade information for the record on that exact trading day. If one party or both parties of the transaction instruct a settlement agent for the trade settlement, then the settlement agent should report the trade information to CFETS.

E. Possible Challenges and Expected Changes of Regulatory Rules

In recent years, the development of China's bond market has made remarkable progress. However, some structural problems remain.

1. It is necessary for regulatory authorities to form a more active and sustainable strategy in building a benchmark interest rate.

This shall also improve the liquidity of the secondary market, facilitate the innovation process of hedging instruments for interest rate risk (such as futures and options), and make possible the implementation of a monetary policy through direct financing instruments.

2. Presently, the corporate credit fixed-income market is facing the challenge of establishing a sub-market that can bring in issuers with lower credit ratings such as small- and medium-size enterprises (SMEs), private enterprises that are excluded from the market, and enterprises that are relying on higher-cost bank loans, to access the fixed-income market to raise money.

Several innovations in relation to SMEs were launched recently, including SMEs' collective notes and the initiation and establishment of the China Bond Insurance Co. Ltd. These measures have achieved declared targets partially.

Companies with lower credit ratings planning to enter the market may face legal restrictions on risks stipulated by regulators. A more flexible approach would enable the creation of a segment of eligible investment-grade companies (such as BBB-, three levels below the ratings currently accepted by the market) to issue bonds.

Reform measures by both buy side and sell side are needed, along with innovations to attract appropriate investors.

3. Another challenge is providing better service for financing SMEs' needs.

The Shanghai Stock Exchange implements a multi-layer market system, which includes the main Board, SME Board, and the Growth Enterprise Market (GEM) Board. This can be deemed as a step forward in the correct direction.

The GEM Board, launched in 2009, has demonstrated an original and successful innovation with a bright future. It is envisioned to facilitate the financing needs of listed startups with great potential for future growth that originally raised money through private equity fund. The GEM board is expected to play a key role in the financial service chain by offering an exit channel for private placement.

The establishment of a smooth transmission channel between private equity funds and public offerings is very important from two aspects: 1) offer a sustainable financing channel for SMEs, and 2) increase the proportion of private enterprises in the stock exchange.

III. Trading of Bonds and Trading Market Infrastructure

A. Trading of Bonds

1. OTC Trading of Bonds

China's bond market is constituted of the Inter-bank Bond Market and the exchange market. The Inter-bank Bond Market is an OTC market, and accounts for about 94% of outstanding bond value, as well as 99% of bond trading volume. It was established in 1997 and has recorded an average annual growth rate of over 50% since 2005.

The main traded instruments in the Inter-bank Bond Market include cash bond, collateral repo, outright repo, bond lending, and bond forward.

Table 3.1 Trading Volume in the Inter-bank Bond Market (¥ billion)

Year	Cash Bond	Collateral Repo	Outright Repo	Bond Forward	Total
1997	0.97	-	-	-	0.97
1998	3.32	-	-	-	3.32
1999	7.74	-	-	-	7.74
2000	68.24	1,578.17	-	-	1,646.41
2001	83.93	4,013.33	-	-	4,097.26
2002	441.17	10,188.52	-	-	10,629.69
2003	3,084.84	11,720.34	-	-	14,805.18
2004	2,504.11	9,310.49	126.27	-	11,940.87
2005	6,013.31	15,678.43	222.28	18.10	21,932.12
2006	10,256.39	26,302.06	289.21	66.39	36,914.05
2007	15,604.34	44,067.23	725.26	251.48	60,648.31
2008	37,115.76	56,382.95	1,737.57	500.27	95,736.55
2009	47,269.94	67,700.73	2,589.13	655.64	118,215.44
2010	64,043.25	84,653.35	2,940.21	318.34	151,955.15

Source: China Foreign Exchange Trade System (CFETS).

The main products in the inter-bank Bond market include government bonds, central bank papers, policy bank bonds, short-term papers, MTNs, corporate bonds, financial bonds, local government bonds, collective notes, international development institutions bonds, subordinated bonds, hybrid capital bonds, asset-backed securities,

and super short-term commercial paper. Currently, policy bank bonds, central bank paper, MTNs and treasury bonds are the four most actively traded bonds in the inter-bank bond market.

At present, the Inter-bank Bond Market has over 10,000 members, covering all types of financial institutions such as commercial banks, securities companies, insurance companies, and various kinds of investment vehicles like mutual funds and pension funds. Among these, commercial banks are the most active participants.

The inter-bank Bond Market facilitates two trading modes: bilateral negotiation and click-and-deal. The OTC bond market officially introduced the market-maker mechanism in 2001 to improve market liquidity and enhance efficiency. Currently, 25 market makers provide bid-offer quotation for underlying bonds that cover nearly all types and terms, and three of the 25 market makers are subsidiary companies of foreign banks. Another major market policy, named the settlement agency mechanism, allows non-financial companies to invest in the inter-bank Bond market through settlement agent banks. As of December 2011, there are 46 settlement agents in the inter-bank bond market. The two mechanisms constitute the major Inter-bank Bond market structure and play an effective role in market growth and risk management.

2. Bond Repurchase Market

Bond repo has two sub-types: collateral repo and outright repo. The major difference between the two is that the latter involves transfer of bond ownership during the repo period while there is no transfer of ownership in collateral repo. In China's OTC market, collateral repo accounts for over 97% of total repo market in terms of trading volume. The terms of collateral repo transactions range from 1 day to 1 year, and are divided into 11-period categories, including 1-day (overnight) repo, 7-day repo (2-7days), 14-day repo (8-14days), etc. The terms of outright repo range from 1 day to 91 days. The most actively traded repos are in the 1-day and 7-day categories, which account for over 90% of repo transactions. Market participants vary from commercial banks, other financial institutions, to non-financial firms and non-institutional investment products.

The China Foreign Exchange Trade System (CFETS) composes the Fixing Repo Rate based on 1-day, 7-day and 14-day collateral repos. The Fixing Repo Rate is now one of the key benchmarks for the financial market in China, and also widely used in the derivatives market.

3. Proprietary Trading Systems

CFETS, also known as the National Inter-bank Funding Center, is the unified trading platform for the inter-bank Bond market in China. CFETS has been operating the inter-bank bond market trading platform since 1997, and is now developed into a unique OTC electronic bond-trading platform in China with comprehensive functions of trade, post-trading service, risk management, and information service. It is a concentrated platform which contains all instruments in the bond market including cash-bond trading, bond repo, bond forward, and other OTC instruments like inter-bank offering, and derivatives like interest rate swap, forward rate agreement, and credit risk mitigation warranties.

Under CFETS' system, negotiation is applied to all inter-bank products while one-click trading (点击成交) is only applied to cash-bond and interest rate derivatives. CFETS has set up an interface for members to transfer data from CFETS to their internal system. The straight-through processing between CFETS and depositories (CCDC and Shanghai Clearing House) has also been set up, through which transaction data is transferred to the settlement system automatically.

CFETS also provides market information like quotes and prices on a real-time basis. As for post-trading management, the trading system contains specific modules for post-trade supervision and risk management.

4. Secondary Market Yields and Terms of Bond Issues

Both CCDC and CFETS compose yield curves for the Inter-bank Bond Market. CFETS composes real-time and end-of-day yield curves on six types of bonds. The real-time yield curves are the only real-time benchmarks in China's Inter-bank Bond Market. Every trading day the first curve is published at 9:30 a.m., and the curve is updated hourly until the system closes. The curves are based on benchmark bonds.

Compiled by CCDC since 1999, the Chinabond Yield Curves have been applied widely, serving the aims of market supervision, as well as pricing benchmark, internal control of financial institutions, and performance evaluation of banks, funds, insurance companies, other market participants.

5. Transparency in Bond Pricing

- a. To enhance transparency in the bond market, especially in the OTC market, both CFETS and CCDC provide various information services.
- b. CFETS discloses market information, particularly pricing-related statistics via the trading system on a real-time basis, to provide market members with a thorough and prompt market description. Summarized information is also disclosed on the website www.chinamoney.com.cn.
- c. The CCDC also publishes extensive bond market information, including issuances, registration, listing, income payment as well as settlement quotation and OTC bilateral prices, through the website www.chinabond.com.cn, established by CCDC in 1998.
- d. CFETS and CCDC also undertake the responsibility of market supervision to monitor abnormal transactions, which further improve market transparency in the OTC bond market.

IV. Impediments/Restrictions for the Realization of a Cross-Border Inter-Regional Market

A. Issues Concerning Accounting Standards

First, amendments to relevant items of the Accounting Standards for Enterprises are still in process. In 2005, the Ministry of Finance (MOF) of China made concentrated efforts to formulate and complete the system of accounting standards for enterprises by drawing on comprehensive accounting reform experiences over the past years. During that period, the International Accounting Standards Board (IASB) sent experts to China and worked with the Accounting Department of the MOF.

On 8 November 2005, China Accounting Standards Committee concluded a joint statement with IASB, stating that the system of Accounting Standards for Enterprises formulated by China converged with the international financial reporting standards. Subsequently, the MOF will continue its efforts in working towards the convergence between Chinese Accounting Standards for Enterprises and international financial reporting standards. The MOF is also in the process of completing all amendments to the Chinese Accounting Standards for Enterprises before the end of 2011.

Secondly, the accounting treatment regarding specific bond trading operations is still ambiguous. For example, present provisions do not provide clarity on whether outright repos shall be treated as accommodation or spot bond trades; these two methods differ greatly from an accounting perspective. If an outright repo is treated as accommodation, the bond is still available in the debt accounts in spite of being excluded from the self-operated securities of the reverse repurchaser; the self-operated securities can become negative once the reverse repurchaser sells the repurchased bonds, which shall be a challenge for the accounting system in the country. In case outright repo is considered as spot bond trades, a potential loss during the tenure of the repo shall need to be booked as a realised loss at the time of the far leg.

B. Issues Concerning Information Disclosure and Investors' Protection

At present, there are differences between domestic and overseas rules on information disclosure, different specific requirements on disclosure documents within the duration of a bond, and different provisions on the language of the rules. As such, under the current framework of rules on information disclosure for existing debt-financing instruments, the introduction of overseas issuers may pose the risk of being unable to provide required information for disclosure within the duration of the bond.

By taking into account possible situations that may emerge after the creation of a cross-border bond market, the establishment and improvement of relevant mechanisms for investors' protection is extremely important. At present, the domestic bond market has introduced international mechanisms for investors' protection such as the bond agents and bondholders meeting system as stipulated in Article 7 of the *Guidelines for Non-Financial Enterprise Medium-Term Notes in the Inter-bank Bond Market*, the *Rules for Meetings of Non-financial Enterprise Debt Holders in the Inter-bank Bond Market*, Articles 23 to 31 of the *Pilot Rules on the Issuance of Corporate Bonds*. These are regulations relating to investors' protection, and related provisions shall be continuously improved along with the demand for the development of a cross-border bond market.

V. Description of the Securities Settlement System

A. The Custody System

There are three central securities depositories (CSDs) serving China’s bond market, namely China Central Depository and Clearing Corporation, Limited (CCDC), Shanghai Clearing House (SHCH), and China Securities Depository and Clearing Co. Ltd. (CSDCC). Specifically, CCDC and SHCH are the CSDs for the China Inter-bank Bond Markets (OTC markets), while CSDCC serves the exchange markets.

For Treasury bonds, CCDC plays the role of central custodian, while commercial banks and CSDCC work as sub-custodians for the commercial bank OTC bond market and the exchange bond market, respectively. Bonds of other types, however, are in the central custody of their respective CSDs.

B. The Securities Settlement Infrastructures

Figure 5.1 Bond Market Infrastructure Diagram

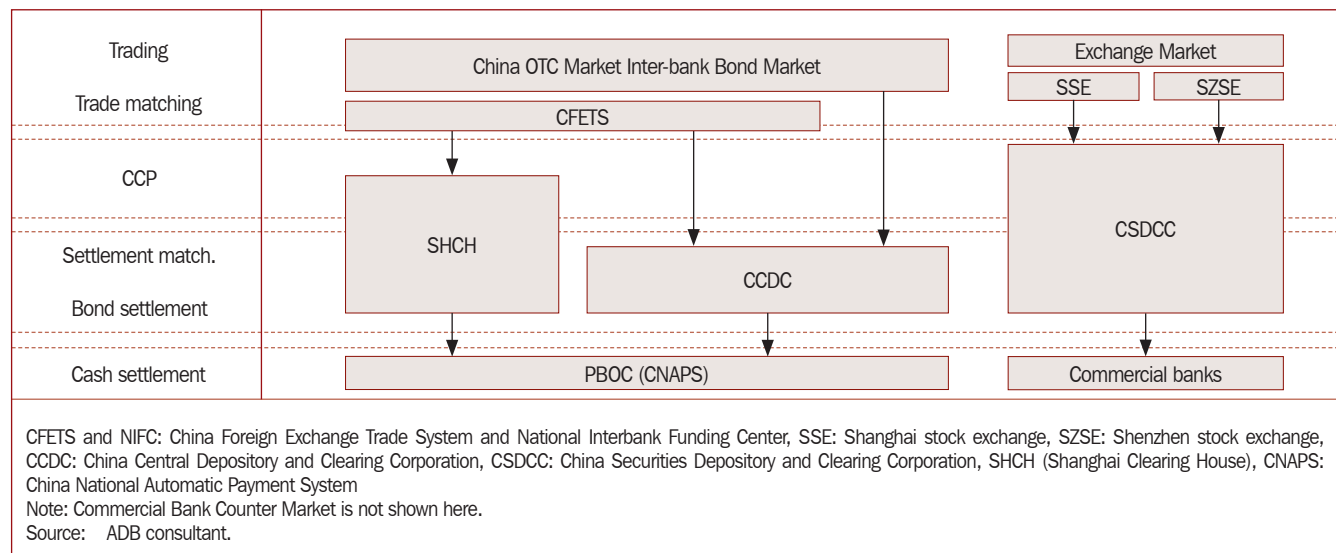

1. Central Securities Depositories and Products Custodians

CCDC mainly takes the custodian role for instrument types such as government bonds, central bank bills, financial bonds, corporate credit bonds, MBSs and asset-backed securities (ABS), and foreign bonds.

SHCH basically deals with innovative instruments and money-market tools like super and short-term commercial papers, and credit risk mitigation instrument. CSDCC is responsible for the custody of exchange-traded securities, including Treasury bonds, corporate bonds, equities, warrants, exchange-traded funds, and ABSs.

2. Transaction Confirmation and Straight-Through Processing

CCDC and SHCH have implemented straight-through processing by connecting the custody systems with the trade system of the National Inter-bank Funding Center (NIFC).⁷ In the daytime, the trade system would send the transaction data to the CSDs in near real-time. The CSDs generate settlement instruction, indicating the transaction is to be settled.

3. Settlement Cycles

At present, bond settlement between inter-bank bond-market participants is done by CCDC or SHCH in a near-real-time trade-by-trade mode with a settlement cycle of T+0 or T+1. For exchange markets, the settlement cycle is T+1.

4. Settlement Methods

Settlement methods in the Inter-bank Bond Market include free of payment, payment against delivery, delivery against payment, and delivery versus payment (DVP). CCDC and SHCH have implemented the DVP mechanism by connecting their business systems with China's central bank's RTGS system. For exchange markets, the settlement method is DVP.

5. Bond Settlement Processing Flow Chart

Table 5.1 Settlement Processing Overview Chart

Items		Inter-bank Bond Market		Commercial Bank OTC Bond Market	Exchange Bond Market
Trading		Trade system of NIFC	Telephone/Broker	Commercial banks counter	Exchange trade systems
Matching	Trade matching	Trade system of NIFC	Trade system of NIFC	–	SSE SZSE
	Post-trade matching	CCDC/SHCH	CCDC/SHCH		
	Clearing	SHCH/bilateral clearing between counterparties		–	CSDCC
	Settlement	CCDC/SHCH	CCDC/SHCH	–	CSDCC
	DVP	Gross DVP	Gross DVP	–	Net DVP
	Fund Settlement	High-Value Payment System (HVPS)		Commercial Banks	Internal Cash Settlement System
	Bond transfer	CCDC/SHCH	CCDC/SHCH	Commercial Banks	CSDCC

CCDC = China Central Depository and Clearing Co. Ltd.; CCP = central counterparty; CSDCC = China Securities Depository and Clearing Co. Ltd.; DVP = delivery versus payment; NIFC = National Inter-bank Funding Center; OTC = over-the-counter; SHCH = Shanghai Clearing House
Source: People's Bank of China.

⁷ CFETS and NIFC

C. The Bond Transaction Flows

Figure 5.2 Bond Transaction Flow for Domestic Trades in the Over-the Counter Market/Delivery versus Payment

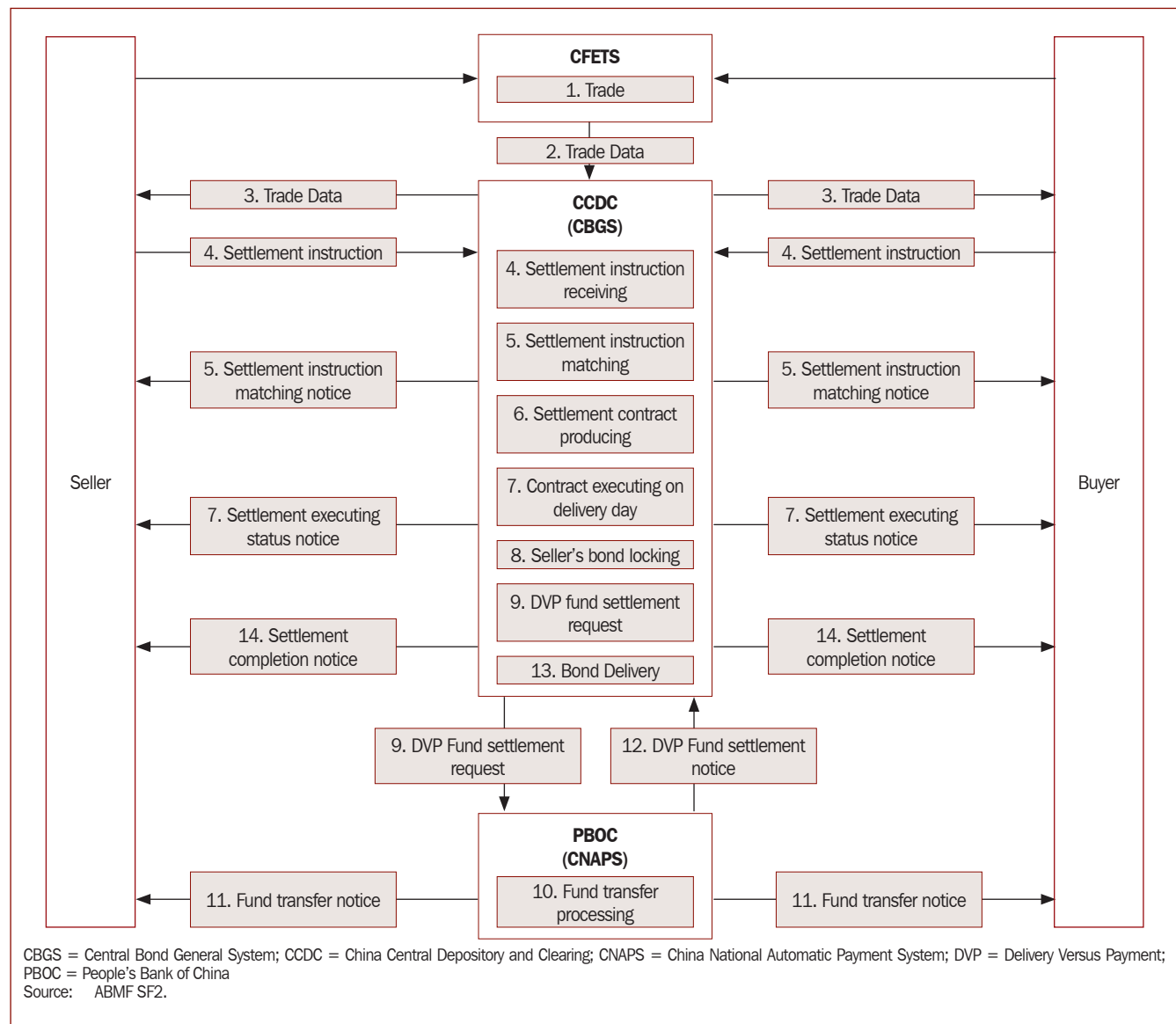

OTC Market

1. Seller and buyer trade bond via China Foreign Exchange Trade System (CFETS). CFETS provides automatic trade matching function. But, most of the bonds are traded bilaterally in China OTC Market by telephone or some other ways. The trade data are entered to CFETS for price transparency.
2. CFETS sends trade data to China Central Depository and Clearing Co. Ltd. (CCDC). About 5% of trade data are entered to CCDC directly from seller and buyer (refer to 4. Settlement instruction).
3. CCDC sends trade data to seller and buyer for verification.

4. When seller and buyer received trade data from CCDC, seller and buyer verify the data. If the data are correct, seller and buyer send affirmative message to CCDC. The messages are regarded as “settlement instructions” to CCDC. About 5% of trades are directly entered to CCDC after traded in China OTC Market. In this case, one party (either seller or buyer) needs to send settlement instruction into CCDC system. The settlement instruction needs to contain full message items necessary for the settlement. CCDC system will automatically ask the other party to confirm. If not, CCDC won’t process settlement. After matching the order (local matching), CCDC will settle the trade in FOP or DVP as requested by customers.
5. CCDC matches settlement instructions from the seller and buyer and notifies matched result.
6. CCDC produces settlement contract.
7. On the settlement day, CCDC executes the settlement contract and notifies the status to the seller and buyer.
8. CCDC blocks seller’s bond to secure DVP transaction.
9. CCDC sends DVP fund settlement request to People’s Bank of China (PBOC).
10. PBOC executes fund settlement. Fund is transferred from buyer’s current account to seller’s current accut by High Value Payment System (HVPS) of CNAPS.
11. PBOC sends fund transfer notice to the seller and buyer.
12. PBOC sends DVP fund settlement notice to CCDC.
13. CCDC executes bond delivery (release blocked bond).
14. CCDC sends settlement completion notice to the seller and buyer.

Figure 5.3 Bond Transaction Flow for Domestic Trades Exchange Market/Delivery versus Payment

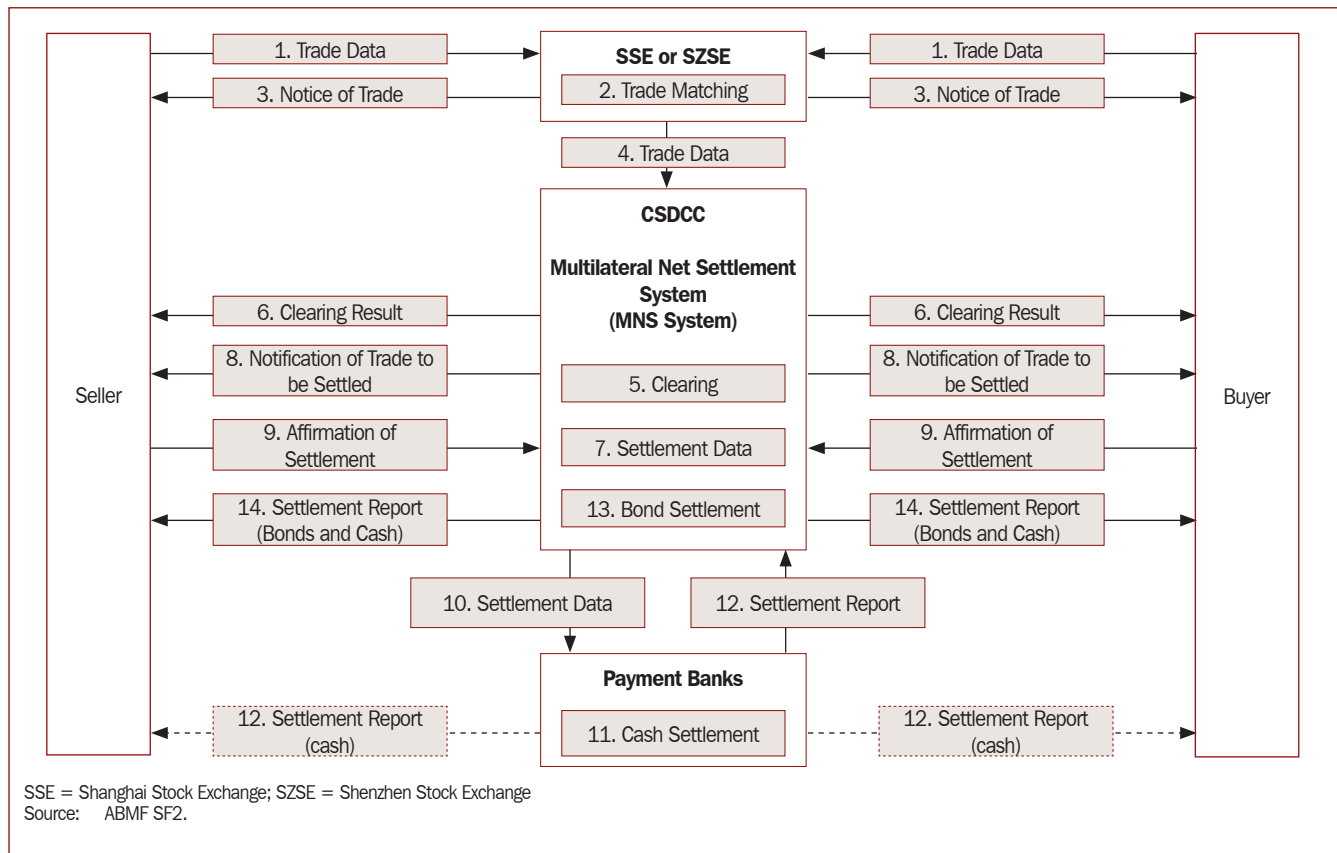

Exchange Market

1. The seller and buyer trade via Shanghai Stock Exchange (SSE) or Shenzhen Stock Exchange (SZSE).
2. SSE/SZSE collates orders from the seller and buyer.
3. SSE/SZSE sends notice of trade to the seller and buyer. (to be confirmed)
4. SSE/SZSE sends trade data to China Central Depository and Clearing Co. Ltd. (CSDCC).
5. Clearing function in CSDCC executes clearing process.
6. Clearing function in CSDCC sends clearing result to the seller and buyer.
7. Clearing function in CSDCC sends settlement data to CSD function in CSDCC.
8. CSD function in CSDCC sends notice of trade to be settled to the seller and buyer.
9. The seller and buyer send affirmation of Settlement.
10. CSDCC sends settlement data to payment banks.
11. Payment banks perform cash settlement.
12. Payment banks sends settlement reports to CSDCC, seller and buyer.
13. CSD function in CSDCC executes bond settlement.
14. CSDCC sends settlement report (bonds and cash) to the seller and buyer

Figure 5.4 Bond Transaction Flow for Foreign Investors Exchange Market/Qualified Foreign Institutional Investors

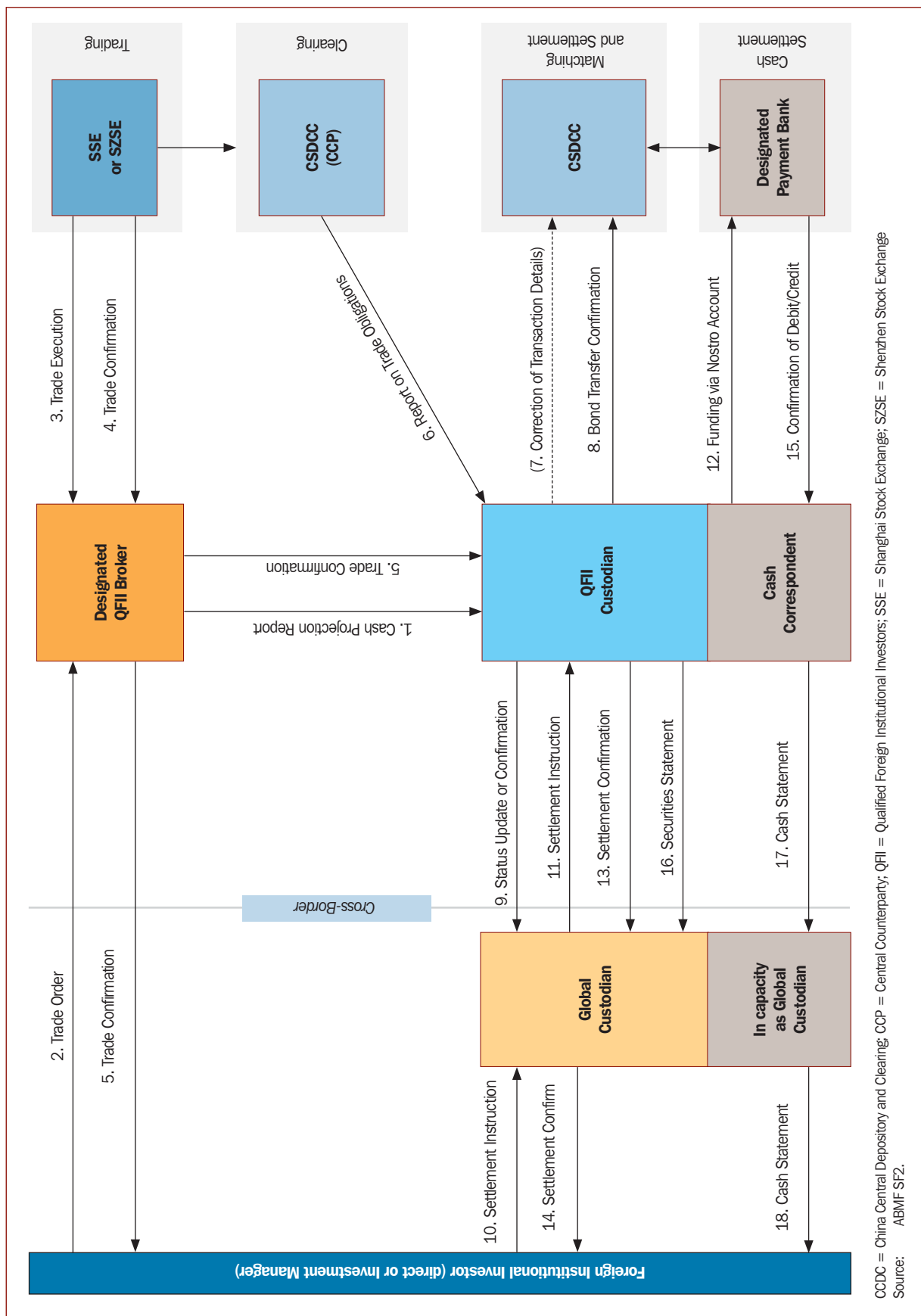

Trade Data

1. QFII Custodian send cash projection report to Designated QFII Broker
2. QFII places order with Designated QFII Broker
3. Designated QFII Broker checks balance, executes trade on Shanghai Stock Exchange (SSE), or Shenzhen Stock Exchange (SZSE)
4. Designated QFII Broker receives trade confirmation
5. Designated QFII Broker sends trade confirmation to QFII, and to QFII Custodian
6. QFII Custodian downloads Report on Trade Obligations from CSDCC (Clearing function)
7. Only in the event of a discrepancy, QFII Custodian needs to contact CSDCC
8. CSDCC (Settlement function) sends confirmation of transfer of bonds to QFII Custodian (on T evening)

Settlement Date (T+1)

9. QFII Custodian sends status update or partial settlement confirmation to Global Custodian
10. QFII instructs Global Custodian on settlement details
11. Global Custodian instructs QFII Custodian on settlement details
12. QFII Custodian funds settlement clearing reserve account (CSDCC account at Payment Bank)
13. After cash settlement deadline (in effect completion of trade settlement), QFII Custodian sends settlement confirmation to Global Custodian
14. Global Custodian sends settlement confirmation to QFII
15. Payment Bank sends debit/credit information in form of cash statement to QFII Custodian
16. QFII Custodian sends securities statement to Global Custodian (end of day)
17. QFII Custodian sends cash movement confirmation/cash statement to Global Custodian (end of day)
18. Global Custodian sends cash movement confirmation/cash statement to QFII (end of day)

VI. Costs and Charging Methods

Currently, the costs and charging methods in the China bond market involve trading, clearing and settlement, and registration and custody, respectively.

A. Charging Methods for Trading in China's Bond Market

Transaction in China's Inter-bank Bond Market involves the trade system of NIFC and money-brokering corporations, while exchange market in-house trading is done through the Shanghai Stock Exchange (SSE) and Shenzhen Stock Exchange (SZSE). Treasury bonds are also traded through commercial banks' counters, as well. Charging methods for trading in China's Inter-bank Bond Market are as follows:

1. NIFC charges transaction fees based on the transaction amount from both parties. Transaction fee rates differ for various products or financing maturities, ranging from 0.005 to 0.25 basis points (bp), with a ceiling of ¥1,000 per transaction.⁸
2. Money brokers' commission fee rate is subject to negotiation with each client.
3. SSE charges transaction fees and security transaction regulation fees based on the transaction amount from both parties. Transaction fee rate is 1 per million with a ceiling of ¥100 per transaction; security transaction regulation fee rate is 0.1 bp.⁹
4. SZSE charges transaction fees and security transaction regulation fees based on the transaction amount from both parties. Transaction fee rate for convertible bonds is 0.40 bp; transaction fee rates for other bonds range from ¥0.1 to ¥10 per transaction. Security transaction regulation fee rate is 0.1 bp.¹⁰
5. Commercial banks' OTC bond services charge is included in their quoted price, and, therefore, with no extra fees.

⁸ China Foreign Exchange Trade Center and the National Interbank Funding Center. <http://www.chinamoney.com.cn>

⁹ Shanghai Stock Exchange. <http://www.sse.com.cn>

¹⁰ Shenzhen Stock Exchange. <http://www.szse.cn>

B. Charging Methods for Clearing and Settlement

Clearing and settlement in the China bond market is through CCDC, SHCH, CSDCC, and commercial banks counters.

1. CCDC charges settlement fees from both parties for every transaction. For different bond types and settlement methods, fees range from ¥100 to ¥200.¹¹
2. SHCH charges settlement fees from both parties for every transaction. Settlement fees range from ¥100 to ¥200 per transaction according to bond types and settlement methods.¹²
3. CSDCC charges 0.10 bp as security settlement risk fund from both parties based on the transaction amount.¹³
4. Commercial banks' OTC bond service charges ¥50 for non-trade transfer rollout per transaction.¹⁴

C. Charging Methods for Registration and Custody

Fees for registration and custody in China's bond market are charged by CSDs.

1. CCDC charges issuance and registration fees by a certain proportion of the issuance amount from 0.6 to 1.15 bp according to the issuance amount and maturity.¹⁵
2. SHCH charges issuance and registration fees ranging from 0.3 to 0.5 bp of face value according to the bond maturity.¹⁶
3. CSDCC charges corporate bond issuance and registration fees in proportion to the issuance amount and maturity, and ranging from 0.1 to 0.6 bp. CSDCC's custody fees include pledge registration fees and crossmarket custody fees that range from ¥10 to ¥10,000.¹⁷
4. Commercial banks' OTC bond service charges ¥10 for opening a custody account and ¥20 for cross-market custody per time.¹⁸

¹¹ China Central Depository Clearing Co., Ltd. <http://www.chinabond.com.cn>

¹² Shanghai Clearing House. <http://www.shclearing.com>

¹³ China Securities Depository and Clearing Co. Ltd. <http://www.chinaclear.cn>

¹⁴ Source: Commercial banks' websites

¹⁵ China Central Depository and Clearing Co. Ltd. <http://www.chinabond.com.cn>

¹⁶ Shanghai Clearing House. <http://www.shclearing.com>

¹⁷ Based on data CSDCC reported to ASEAN+3 Bond Market Forum.

¹⁸ Source: Commercial banks' websites

VII. Market Size and Related Statistics

A. Issuance, Custody and Settlement in China's Inter-bank Bond Market

Table 7.1 Issuance, Custody and Settlement in China's Inter-bank Bond Market, 5-Year Period Covered (¥ trillion)

Year	Issuance	Custody	Settlement
2005	4.22	7.26	22.87
2006	5.71	9.26	38.35
2007	7.98	12.22	63.13
2008	7.07	15.11	101.32
2009	8.65	17.53	122.09
2010	9.51	20.17	162.79

Source: Central Depository and Clearing Co., Ltd. www.chinabond.com.cn

B. China's Financing Structure from 2005–2009

Table 7.2 China's Financing Structure, 5-year Period Covered (¥ trillion and percentage)

Year	Total Financing	Bank Loans	% of Total Financing	Treasury Bonds	% of Total Financing	Corporate/Enterprise Bonds	% of Total Financing	Equity	% of Total Financing
2005	31,507	24,617	78.1	2,996	9.5	2,010	6.4	1,884	6.0
2006	39,874	32,687	82.0	2,676	6.7	2,266	5.7	2,246	5.6
2007	49,817	39,205	78.7	1,790	3.6	2,290	4.6	6,532	13.1
2008	60,486	49,854	82.4	1,027	1.7	6,078	10.1	3,527	5.8
2009	130,747	105,225	80.4	8,182	6.3	12,320	9.4	5,020	3.8

Source: China Financial Market Development Report (2009).

C. Depository Products on the Shanghai Clearing House

Table 7.3 Statistics on Shanghai Clearing House Custody Products
(As of 25 February 2011, Accumulative)

	No. of Securities Issued	Total Amount of Securities Issued (in ¥100 million)	No. of Settlement	Principal Settled (in ¥100 million)	Fund Settled (in ¥100 million)
Super and short-term commercial Papers	11	850.00	70	217.15	217.23
Credit risk mitigation warranty	8	6.90	6	2.40	0.01

Source: Shanghai Clearing House. <http://www.shclearing.com>

D. Exchange-Traded Bonds Transactions

The succeeding tables provide the statistics on exchange-traded bonds transactions.

Table 7.4a General Information on Listed Bonds until February 2011

Bond Type	Shanghai Stock Exchange	Shenzhen Stock Exchange
Government bonds	137	137
Local government bonds	60	60
Corporate/Enterprise bonds	264	68
Convertible bonds	8	5

Source: China Securities Depository and Clearing Co. Ltd. (CSDCC) data supplied to ASEAN+3 Bond Market Forum (ABMF).

Table 7.4b Bond Turnover of the Shanghai Stock Exchange (¥ billion)

Bond Type	2004	2005	2006	2007	2008
Government bonds	339.59	321.94	153.74	126.22	207.59
Corporate/enterprise bonds			12.46	31.64	140.64
Convertible bonds			16.90	21.18	30.16
Repo	4,660.18	2,491.91	1,629.92	1,860.89	2,430.68

Source: CSDCC data supplied to ABMF.

Table 7.4c Bond Turnover of the Shenzhen Stock Exchange (¥ billion)

Bond Type	2004	2005	2006	2007	2008
Government bonds	0.54	0.78	0.33	0.51	4.66
Corporate/enterprise bonds	2.17	2.98	4.03	6.54	32.37
Convertible bonds	29.87	19.18	10.55	19.74	12.05

Source: CSDCC data supplied to ABMF.

VIII. Islamic Bond (*Sukuk*) Market

At present, there is no Islamic bond (*sukuk*) market in mainland China.

IX. Direction of Future Development

Regulatory authorities are determined to promote the overall sustainable development of the bond market in China to optimize the allocation of market resources and better serve the real economy.

The first step is to further promote the development of the OTC bond market for qualified institutional investors, and strengthen market discipline and risk-sharing mechanism.

Second is to encourage innovations and improve supervision and regulations.

Third is to lay a solid foundation for the bond market by enhancing market infrastructure and risk prevention.

Moreover, strengthening the coordination of regulation, along with the formation of market-wide efforts for the market development will be pursued.

Furthermore, the connectivity between exchange market and the Inter-bank Bond Market based on a clear direction of market development should be undertaken. Last but not least, the opening up of the bond market in an active and robust way will likewise be promoted.

NOTE:

This guide was produced based on the official comments made by the PBOC on the ABMF Questionnaire.

The English version of relevant rules and regulations is used for reference only. Should the English version not match the original text in Chinese, the Chinese version shall prevail.

Hong Kong, China Bond Market Guide

Contents

Acknowledgement	vii
I. Structure, Type, and Characteristics of the Market	1
A. Overview	1
B. Types of Bonds	2
C. Methods of Issuing Bonds	7
D. Credit Rating Agencies and Credit Rating of Bonds	8
E. Bond-Related Systems for Investor Protection	8
F. Governing Laws of Bond Issuance	8
G. Transfer of Interests in Bonds	9
H. Definition of Securities	11
I. Self-Governing Rules behind the Market	14
J. Bankruptcy Procedures	14
K. Meetings of Bondholders	14
L. Event of Default	15
M. Options Available on the Bond Market	16
N. Parties in a Bond Issue and Their Respective Roles	17
O. Major Participants in the Market	18
II. Primary and Secondary Markets Regulatory Framework	20
A. Hong Kong Market Regulatory Structure	20
B. Regulation of the Hong Kong Securities Markets	22
C. Regulations and Rules Related to Issuing Debt Instruments	24
D. Related Rules and Regulations on Investment in Debt Securities	24
E. Investor Protection	25
F. Taxation Framework and Tax Requirements	25
G. Offers of Bonds to Professionals	28
H. Definition of “Professional Investors” in the Hong Kong, China	29
I. Challenges and Expected Changes	32
III. Trading of Bonds and Trading Market Infrastructure	35
A. Over-the-Counter Market Trading	36
B. Over-the-Counter Market Business Process	36
C. Hong Kong Bond Transaction Flow (For Foreign Investors)	39

IV. Future Developments	41
A. Repo Market	41
B. Liquidity in the Secondary Market	41
C. Renminbi-Denominated Bond Market	41
D. Conclusion.....	42
V. Description of the Securities Settlement System.....	43
A. Securities Settlement Infrastructure.....	43
B. Definition of Clearing and Settlement.....	44
C. Challenges/ Expected Changes.....	45
VI. Cost and Charging Methods.....	46
A. Initial Fees.....	46
B. Maintenance (Ongoing) Costs.....	46
VII. Market Size and Statistics	47
A. Market Size.....	47
B. The Renminbi Bond Market	47
C. Debt Issuance and Syndicated Loans vs. Equity Market.....	47
D. Market Data from <i>AsianBondsOnline.com</i>	48
VIII. Presence of an Islamic Finance (Islamic bond [<i>Sukuk</i>]) Market	56
A. Regulatory Framework for Islamic Finance	56
B. Types of Available Instruments, Segments, and Tenure.....	56
C. Basic Market Infrastructure for Islamic Finance	56
D. Tax-Related Issues.....	56
IX. History of Debt Market Development	58
A. Overview	58
B. The Development of Hong Kong Debt Markets	58
X. Next Step ⇒ Future Direction	63
A. Offshore Renminbi Bond Market (Dim-Sum Bond).....	63
B. Enhancements to Post-Trade Processing in Asian Bond Markets	63
C. Group of Thirty Compliance	64
D. Group of Experts Barrier Report Market Assessment - Hong Kong (April/2010).....	65
Appendixes	66
References	72

Box, Figures, and Tables

Box

Box A2.1.	Appendix 8 Listing Fees, Transaction Levies and Trading Fees on New Issues and Brokerage	69
-----------	------------------------------------------------------------------------------------------------	----

Figures

Figure 3.1	Bond Settlement Infrastructure in Hong Kong, China.....	37
Figure 3.2	Business Process Flowchart Hong Kong Bond Market (Over-the-Counter Market/Delivery versus Payment)	37
Figure 3.3	Hong Kong Bond Transaction Flow for Foreign Investors.....	39

Tables

Table 2.1	Current Levy on Exchange-Trade Product Transactions	25
Table 2.2	Duties and Taxes in the Hong Kong Market	26
Table 6.1	Market Charges in the Hong Kong, China Market.....	46
Table 7.1	Size of Local Currency Bond Market in Percentage of Gross Domestic Product (Local Sources).....	48
Table 7.2	Foreign Currency Bonds to Gross Domestic Product Ratio.....	50
Table 7.3	Foreign Currency Bonds Outstanding (Local Sources) (USD billion)	51
Table 7.4	Issuance Volume of Local Currency Bond Market (USD billion)	51
Table 7.5	Domestic Financing Profile	53
Table 7.6	Trading Volume (\$ billion).....	54
Table 10.1	Group of Thirty Compliance Recommendations.....	64
Table 10.2	Group of Experts Barrier Report Market Assessment on Hong Kong, China	65
Table A1.1	Central Moneymarkets Unit Tariff (CMU Instruments).....	66
Table A1.2	General Debt Securities	69
Table A1.3	Debt Issuance Programme Securities	71

Acknowledgement

The Asian Development Bank (ADB) Team, comprising Satoru Yamadera (Economist, ADB Office of Regional Economic Integration, - September 2011), Seung Jae Lee (Principal Financial Sector Specialist), Shinji Kawai (Senior Financial Sector Specialist, Banking), Shigehito Inukai (ADB consultant), Taiji Inui (ADB consultant), and Matthias Schmidt (ADB consultant), would like to express their sincere gratitude to National Member and Expert Institution, Hong Kong Monetary Authority (HKMA) for its comments on the Central Moneymarkets Unit (CMU) and RTGS systems in Hong Kong.

The ADB Team also would like to express special thanks to Citibank, Deutsche Bank AG, HongKong Shanghai Banking Corporation (HSBC), J.P. Morgan, and State Street for their contribution as International Experts, and the Asia Capital Markets Association as supporter, in providing information from their respective market guides, as well as their valuable expertise. Because of their cooperation and contribution, the ADB Team started the research on solid ground.

Last but not least, the Team would like to thank all the interviewees who provided their comments and responses to questions during the market consultations.

It should be noted that any part of this report does not represent the official views and opinions of any institution which participated in this activity as the ASEAN+3 Bond Market Forum members and experts. The ADB Team bears responsibility for the contents of this report.

February 2012

Asian Development Bank (ADB) Team

List of Interviewees:

Hong Kong, 18 May 2011

Hong Kong Monetary Authority (HKMA)

Slaughter and May, Hong Kong

HSBC, Hong Kong

State Street Bank

J.P. Morgan

I. Structure, Type, and Characteristics of the Market

A. Overview

The bond market in Hong Kong, China, has for some time been a significant market place for issuers and investors, in both domestic and foreign currencies. The range of product offerings, the open access for issuers and investors, both domestic and international, and the increasing significance of offshore RMB bond issuances make Hong Kong, China one of the most frequented international bond markets in Asia.

Public sector bonds come in the form of (a) government bonds; (b) Exchange Fund Bills and Notes (EFBNs) issued by the Hong Kong Monetary Authority (HKMA); (c) bonds issued by statutory bodies (e.g., Hong Kong Airport Authority and Hong Kong Housing Authority); and (d) bonds issued by government-related corporations (e.g., Bauhinia Mortgage-Backed Securities Limited, Hong Kong Mortgage Corporation, Hong Kong Link 2004 Limited, etc.).

The Central Moneymarkets Unit (CMU) was set up primarily to provide computerized clearing and settlement facilities for EFBNs, which provide benchmark yields that guide private debt pricing. In December 1993, the HKMA extended the service to other Hong Kong dollar debt securities. Beginning in December 1994, the CMU has been linked to international clearing systems such as Euroclear. This has helped promote Hong Kong dollar debt securities to overseas issuers and investors who can make use of these links to participate in the Hong Kong dollar debt market. In December 1996, an interface between the CMU and the real-time gross settlement (RTGS) interbank payment system was established. This enables the CMU system to provide its members with real-time and end-of-day delivery versus payment (DVP) services.

The CMU Service provides a central depository for CMU Instruments held within the CMU and an electronic book-entry system which eliminates the physical delivery of CMU Instruments. CMU Instruments lodged with the CMU Service are held with a sub-custodian appointed by the HKMA. Where instruments are lodged with the CMU Service by a CMU Member as the authorized agent of an issuer/acceptor, the lodging CMU Member must have obtained an appropriate authority from the issuer/acceptor authorizing the CMU Member to lodge on its behalf.

Bond trading takes place mostly through over-the-counter (OTC) markets. However, some bonds are traded on the securities market of the Hong Kong Stock Exchanges and Clearing (HKEx), which is the holding company that operates the stock exchange.

In addition, three-year Exchange Fund Note (EFN) futures are traded on the HKEx derivatives market.

Hong Kong, China is a preferred location in Asia for bond issues by foreign and domestic corporations—as well as supranational borrowers—because of the easy access to the market for investors and via international clearing systems.

A wide range of asset classes is available for securitization. The two main asset classes securitized are i) residential and commercial mortgages, and ii) HKMA claims on central governments and central banks. For instance, the Hong Kong Mortgage Corporation (HKMC), which was established by the HKMA, and Hong Kong Link 2004 Limited were set up to facilitate securitization of residential mortgages and toll facilities, respectively.

To promote the development of the local debt market, authorities introduced a number of new products, expanded and improved market infrastructure, and provided a tax and regulatory environment conducive to market development.

B. Types of Bonds

1. By Issuer Category

a. Public Entity Issuers

- i. Hong Kong Government (for Government bonds)
- ii. Hong Kong Monetary Authority
- iii. Statutory Bodies¹
- iv. Government-Related Corporations²

b. Private Entity Issuers

- i. Authorized Institutions³
- ii. Local Corporates
- iii. Multilateral Development Banks⁴
- iv. Non-Multilateral Development Banks, Overseas Borrowers

¹ Statutory bodies that issue bonds include the Hong Kong Airport Authority (HKAA), Hong Kong Housing Authority (HKHA), Kowloon-Canton Railway Corporation (KCRC), Mass Transit Railway Corporation (MTRC), and Hong Kong Mortgage Corporation (HKMC), among others.

² Government-related corporations that issue bonds include Bauhinia Mortgage-Backed Securities Hong Kong Mortgage Corporation (HKMC), Hong Kong Link 2004, Kowloon-Canton Railway Corporation (KCRC), and the Mass Transit Railway Corporation (MTRC).

³ Authorized institution means a bank, a restricted-licence bank, or a deposit-taking company as defined in Section 2 of the *Banking Ordinance*.

⁴ Multilateral development banks (MDB) refer to the Asian Development Bank, the Council of Europe Social Development Fund, the European Company for the Financing of Railroad Rolling Stock, the European Investment Bank, the European Bank for Reconstruction and Development, the Inter-American Development Bank, the International Bank for Reconstruction and Development, the International Finance Corporation, the African Development Bank, and the Nordic Investment Bank.

2. By Type of Bonds

- a. Straight Bonds (Government Bonds and Corporate Bonds)
- b. Floating Rate Notes
- c. Corridor Notes
- d. Index-Linked Bonds
- e. Loan Stocks
- f. Exchange Fund Notes (EFN)

The EFN Programme commenced in 1993. EFNs are Hong Kong dollar fixed-income debt securities issued by the government of Hong Kong, China under the Exchange Fund Ordinance (Chapter 66 of the Laws of Hong Kong) and for the account of the exchange fund.

Currently, EFNs of 2 years, 3 years, 5 years, 7 years, 10 years and 15 years are being issued at such times as the HKMA may determine. Notes of other maturities may be offered from time to time at the discretion of the Financial Secretary.

The EFNs are issued in multiples of HKD50,000 in computerized book-entry form only.

To enhance the liquidity of the secondary market of EFNs and facilitate access by retail investors to the EFN market, the HKMA has listed the EFNs on the Stock Exchange of Hong Kong.

EFBNs and government bonds are in scripless form, while other papers are either bearer or registered and held in physical form.

All government bonds and most corporate bonds are eligible for clearing at the CMU and maintained in book-entry form.

3. Money Markets Instruments

Some of the common money market instruments are listed below:

- a. Certificate of Deposit
- b. Commercial Paper
- c. Exchange Fund Bills

The Exchange Fund Bills Programme was introduced in March 1990. Bills of 91 days (or 90 or 92 days, as the calendar may fall), 182 days, and 364 days are issued under this program.

4. By Listing Status

Between listed and unlisted bonds, unlisted bonds are typically retail bonds that are publicly available. When considering listing, a cost-benefit trade off (fees versus visibility) may exist for an issuer. Fund managers may appreciate access to official pricing but can also determine a realistic price through modelling.

a. Bonds Listed and Traded on the Hong Kong Stock Exchange

Exchange listing of some bonds may probably be due to separate requirements for mutual funds or unit trusts only to buy listed bonds.

b. Bonds (Tap Issue) and Listed Debt Issuance Programmes⁵ that can be Traded Over the Counter

c. Selectively Marketed Securities Status Listing

Selectively marketed securities refer to debt securities marketed to or placed with any number of registered dealers or financial institutions who will either resell such securities as principals off-market or place such securities with a limited number of such investors, thus, “selective marketing” shall be construed accordingly. Nearly all of these securities, because of their nature, will normally be purchased and traded by a limited number of investors who are particularly knowledgeable in investment matters.

d. Non-Listed Bonds that can be Traded Over the Counter

An issuer may choose to issue listed bonds by filing a listing application with the Hong Kong Stock Exchange (HKSE) for the listing of and permission to deal in the bonds on the HKSE, and satisfy certain qualifications for listing as stated in Chapters 23 to 26 of the Listing Rules.

Issuers having debt securities listed or seeking to list debt securities on the HKSE must comply with the requirements set out in the Listing Rules as promulgated by the HKSE. For details, refer to Chapters 22-37 of the Listing Rules.⁶ Chapter 37 of the Listing Rules sets out the requirements for the listing on the exchange of selectively marketed securities.

Most bonds in the Hong Kong domestic bond market are traded OTC. In most cases, the purposes of bonds listing or the Debt Issuance Programme listing on the HKSE are profiling, regulations, and price discovery.

HKEx listed bonds include EFN issues.

5. By Note Forms

- (a) Bonds may either be in bearer or registered form, represented by definitive or global notes.
- (b) The most common form of bonds is global notes which are deposited with the CMU Service in either bearer or registered form.
- (c) There is a proposal for dematerialization by 2013, but this would require amendments to the *Companies Ordinance* (CO).

Bonds in Hong Kong, China may be held within the CMU Service operated by the Hong Kong Monetary Authority (HKMA) in either definitive or global-instrument form. The CMU Service provides a central depository service for CMU Instruments held within the CMU and an electronic book-entry system, which eliminates the physical delivery of CMU Instruments between CMU Members.

⁵ Issues of debt securities where only part of the maximum program’s principal amount or aggregate number of securities under the issue is issued initially, and a further tranche (or tranches) may be issued subsequently.

⁶ Hong Kong Stock Exchanges and Clearing (HKEx). “Chapter 29 (Debt Securities, Tap Issues, Debt Issuance Programmes and Asset-Backed Securities),” *Rules Governing the Listing of Securities on the Stock Exchange of Hong Kong*, http://www.hkex.com.hk/eng/rulesreg/listrules/mbrules/vol1_4.htm.

The bond instruments must be lodged with a sub-custodian appointed by the HKMA. The bond issuer must either be a CMU Member or a CMU Member authorized as a Lodging Agent to use the depository services of the CMU Service.

While the bonds are represented by global notes, the CMU Lodging Agent holds the legal title of these bonds, which are then “immobilized” via the CMU accounts. The holders of the CMU accounts hold the bonds in the Main Account for their own benefit, and the bonds in the General/Specific Custody Accounts for and on behalf of their own customers. For bonds held in the General/Specific Custody Accounts, CMU Members have to refer to their own internal records to ascertain the beneficial ownership of the bonds held in such accounts. The Issuer and the Paying Agent directly make payments of principal, interest or any amounts to the persons for whose account interests in the global bond are credited (as set out in a CMU Instrument Position Report, or as notified to the CMU Lodging Agent by the CMU Service). The individual beneficial holders have to rely on the CMU Member or the CMU Lodging Agent for the delivery of payments and notices to them.

On certain bond issues, a temporary global note is produced where a 40-day lock-up period is required under United States (US) tax and securities laws (Regulation S of the *Securities Act 1933*), during which interest in the securities cannot be traded or paid. After the 40-day period, the temporary global note may be exchanged for a permanent global note (which may be conditional upon the CMU Service having received certification as to the non-US beneficial ownership of the CMU Instruments for compliance with Regulation S). The permanent global note may be exchanged into definitive notes in limited circumstances (e.g., closure of the clearing systems or events of default of the issuer or guarantor).

The CMU Service has linkages with other clearing systems. An investor holding an interest through an account with either Euroclear or Clearstream in any CMU Instruments held in the CMU Service will hold that interest through the respective accounts which Euroclear and Clearstream each have with the CMU Service.

6. By Structure of Bond Issue

There are generally two structures for bond issues—the fiscal agent structure and the trustee structure. The rights and obligations of bondholders and an issuer are different depending on the structure.

It is possible to appoint a trustee but this is not a legal requirement in the Hong Kong bond market under the professional nature of the investors in the Hong Kong market. Only about 10% of bond issues feature a trustee, and no recent such appointment has been observed. Between a trustee and a fiscal agent, the choice typically revolves around the question of cost and may be influenced by the limited number of trustees in the market. The issuer may, however, appreciate having a central party to handle matters.

Many issuers are using the fiscal agent system. However, a fiscal agent may not have fiduciary responsibilities as opposed to a trustee. From a foreign institutional investor’s point of view, a trustee can be considered as safer compared with a fiscal agent.

No recent issues or programmes featured trustees. Trustee provisions under Hong Kong law are considered out-dated in comparison with the *English Trustee Act* (2000).

a. Fiscal Agent Structure

A fiscal agency agreement is executed between the issuer and the fiscal agent as the principal paying agent of the issuer. The issuer pays the interest or the principal to the fiscal agent and the fiscal agent instructs other paying agents to pay the amounts of interest or principal to the bondholders. The fiscal agent then reimburses the paying agents the amounts paid out.

The fiscal agent also has other functions, such as keeping records of payments on the bonds, calling and holding bondholders' meetings when necessary, sending notices to bondholders, and issuing replacements for lost or destroyed bonds.

As fiscal agents are the agents of the issuer, they do not represent the interests of the bondholders. The issuer would generally execute a deed of covenant,⁷ under which bondholders are given direct rights of enforcement against the issuer for default in payment or delivery of definitive bonds.

An example of a fiscal agent structure is the Swire Pacific MTN Financing and Swire Properties Offshore Financing's USD3.5 billion medium-term note (MTN) program dated 18 October 2010.

b. Trustee Structure

Bonds may be constituted in a trust deed, under which the issuer covenants with the trustee to perform its duties under the terms and conditions of the bonds, including to pay any amount due under the bonds and to notify the trustee of any event of default.

The trustee is the representative of the bondholders and exercises the bondholders' rights on behalf of the bondholders and monitors the issuer's performance of its obligations under the bonds.

A paying agency agreement is executed between the issuer, the trustee and the paying agent, under which the paying agent (as agent for the issuer) receives payments due the bondholders from the issuer and pays the relevant interest or principal to the bondholders.

Although, in practice, payments to bondholders are effected through paying agents, the trust deed usually provides power to the trustee, if it declares that an event of default has occurred, to require the issuer to make payments directly to it rather than to the paying agent, or to require the paying agent to act as the trustee's agent, rather than the issuer's agent, when making payments. This protects the bondholders where the issuer is insolvent; the money held by the paying agent would belong to the trustee, rather than being vulnerable to claims by the issuer or the issuer's liquidators.

⁷ A deed of covenant is an arrangement under which a party promises to pay a certain sum regularly to another party within a specified timeframe.

An example of a trustee structure is the MTR Corporation Limited USD3 billion debt issuance program dated 16 November 2010.

C. Methods of Issuing Bonds

1. Government Bonds

Government bonds are issued through competitive tender on a bid-price basis. Tenders must be submitted through recognized dealers, which are also appointed as primary dealers as announced by the government from time to time.

Underwriting arrangements are in place by which recognized dealers, which are also appointed as primary dealers, may be required to subscribe for bonds that have not otherwise been subscribed pursuant to valid tenders.

For details, refer to the Information Memorandum of the Government Bond Programme.⁸

2. Exchange Fund Bills and Notes issued by the Hong Kong Monetary Authority

Exchange Fund Bills are issued through competitive tender on a bid-yield basis, whereas EFNs are issued either through competitive tender on a bid-price basis or through non-competitive tender. The tender and underwriting arrangements are similar to those applicable to the Government Bond Programme.

For details, refer to the Information Memorandum of Exchange Fund Bills Programme and the Information Memorandum of Exchange Fund Notes Programme published in the HKMA website.⁹

3. Bonds Issued by Other Statutory Bodies and Government-Owned Corporations

Methods are similar to those of issuing corporate bonds stated below.

4. Methods of Issuing Corporate Bonds

Private entities generally adopt one of the following methods to issue corporate bonds:

- (a) A public offer for bonds intended to be sold to the public; or
- (b) A private placement for bonds intended to be sold to a small group of investors.

There are some differences in the requirements for the two methods. For instance, a more comprehensive and detailed prospectus is generally required for public offer whereas a relatively simple form of offer document or term sheet suffices for private placement.

For details, refer to Part 2 of the Companies Ordinance (CO). For public offers, specific

⁸ Government of Hong Kong Special Administrative Region. Hong Kong Monetary Authority. 2011. *Government Bond Programme: Institutional Bond Issuance Programme, Information Memorandum*. http://www.hkmb.gov.hk/en/others/documents/Information_Memorandum.pdf

⁹ Hong Kong Monetary Authority. <http://www.hkma.gov.hk/eng/key-functions/international-financial-centre/debt-market-development/exchange-fund-bills-notes.shtml>

reference is made to sections 38 to 41A, and the 17th Schedule of Part 2, in addition to the full prospectus.¹⁰

For bonds to be listed on the HKSE, issuers should also observe the requirements of the Listing Rules, as well as Parts II and XII of the CO including section 44B.¹¹

D. Credit Rating Agencies and Credit Rating of Bonds

There are no credit rating agencies (CRAs) based exclusively in Hong Kong, China. However, the three largest CRAs have offices in this jurisdiction, alongside several smaller multinational CRAs.

In view of the revised Code of Conduct Fundamentals for Credit Rating Agencies issued by the International Organization of Securities Commissions (IOSCO) in May 2008 and the Declaration on Strengthening the Financial System made by the Group of Twenty on 2 April 2009, the Securities and Futures Commission (SFC) is proposing to introduce a regulatory framework to strengthen its oversight of CRAs.

Refer to the Consultation Paper and Consultation Conclusions Concerning the Regulatory Oversight of Credit Rating Agencies published in SFC's website for details.¹²

E. Bond-Related Systems for Investor Protection

Investor protection for investment into debt instruments traded or listed on the Stock Exchange of Hong Kong in the Hong Kong market is evident through, among other measures, the existence of a trustee system and the Investor Compensation Fund (ICF) introduced under the SFO.

While the use of a trustee is not mandatory, the ICF is very much an integral part of the market risk mitigation mechanism and is supported by the Investor Compensation Company Limited (ICC) for the administration of any claims received.

Please refer to details on both trustee regulations and the ICF in the further course of this document.

F. Governing Laws of Bond Issuance

Unless otherwise specified in the prospectus, offer document, or term sheet, the issuance of bonds in Hong Kong, China is governed by and construed in accordance with the laws of Hong Kong, China. Specific references to provisions in other jurisdictions and issue conditions for an offer cannot breach the laws of Hong Kong, China.

¹⁰ Hong Kong Legal Information Institute. <http://www.hklII.org/eng/hk/legis/ord/32/s38.html>

¹¹ Footnote 11. <http://www.hklII.org/eng/hk/legis/ord/32/s44B.html>

¹² Securities and Futures Commission. <http://www.sfc.hk/sfc/html/EN/speeches/consult/consult.html>

Specific laws governing different types of bonds are summarized as follows:

1. Government Bonds

The issuance of government bonds is governed by the *Loans Ordinance* (Chapter 61 of the Laws of Hong Kong). On 8 July 2009, the Legislative Council passed a resolution under section 3 of the *Loans Ordinance* authorizing the Government to borrow up to a maximum principal amount outstanding at any time of HKD100 billion or its equivalent under the Government Bond Programme. For details, refer to the resolution and the *Loans Ordinance* at the Hong Kong Government Bond Programme website.¹³

2. Exchange Fund Bills and Notes issued by the Hong Kong Monetary Authority

EFBNs are issued for the account of the Exchange Fund under the *Exchange Fund Ordinance* (Chapter 66 of the Laws of Hong Kong). For details, refer to the HKMA website.¹⁴

3. Bonds Issued by Other Statutory Bodies and Government-Related Corporations

Issuance of bonds is governed by the respective ordinances governing the statutory bodies and/or the CO where applicable. For instance, bonds issued by the Hong Kong Airport Authority, which is a statutory body established under the *Airport Authority Ordinance* (Chapter 483 of the Laws of Hong Kong), are governed by the same ordinance.

4. Bonds Issued by Private Entities

The issuance of bonds by private entities is governed by sections 41, 44A, 44B and 48A of the CO (Chapter 32 of the Laws of Hong Kong), in addition to the SFO. The terms and conditions of the offers are set out in the offer documents, such as the prospectus. In addition to these, an offer cannot be in breach of other Hong Kong law. For details, refer to the Hong Kong Legal Information Institute (HKLII) website.¹⁵

If the bonds are to be listed on the HKSE, in addition to the CO, issuers have to observe the Listing Rules as mentioned above and other relevant rules promulgated by the HKSE.

If participants use the clearing, settlement and custody services provided by the CMU, the debt securities settlement system operated by the HKMA, they should observe the relevant rules promulgated by the HKMA.

G. Transfer of Interests in Bonds

The transfer of title can be evidenced through registration.

¹³ Hong Kong Government Bond Programme. <http://www.hkgb.gov.hk/en/overview/legal.html>

¹⁴ Footnote 10.

¹⁵ Footnote 11. <http://www.hklII.org/eng/hk/legis/ord/32/>

1. Transfer of Entitlement and Ownership of Securities

Transferees and transferors should send transfer instructions to the CMU for matching and settlement. The transfer of ownership becomes effective upon matching a debit instruction with the corresponding credit instruction and registration in the book entries in the securities accounts of CMU Members within the CMU Service.

2. Entitlement Perfection against a Third Party (Finality of Transactions)

- a. Real-time securities transfer transactions on the CMU Members' Terminal or SWIFT¹⁶ are immediately completed upon successful debiting of funds from the buyer and debiting of securities from the seller, and are deemed final (not subject to waiting time).
- b. End-of-day securities transfer transactions are balanced during the CMU end-of-day settlement processing.
- c. Notwithstanding the mode or means of transfer, all local securities transfer instructions effected through the CMU Service shall be settled by the HKMA, debiting or crediting the relevant securities accounts of the CMU Members concerned; once debited or credited to such securities accounts, such securities transfer instructions shall be deemed made, completed, irrevocable and final.
- d. The situation can be more complex where the securities transfer instructions are effected through linkages with other regional central securities depositories (CSDs) including the Korea Securities Depository, Austraclear, and China Central Depository and Clearing (CCDC), or with international CSDs (ICSDs), including Clearstream or Euroclear.
- e. It is also worth noting that the finality of the transactions settled through the CMU system is protected from insolvency laws (including liquidators and receivers) under section 19 of the *Clearing and Settlement Systems Ordinance* (Cap 584). For example, securities transactions, once settled, may not be set aside on grounds of unfair preference.

3. Prohibited transfers

- a. On-exchange naked short selling of listed securities is prohibited in Hong Kong, and all CMU Members must undertake not to incur a short position in any of the CMU Instruments. Securities may only be sold at or through a recognized stock market if the seller (as principal) or his principal (himself as agent) has, or has reasonable grounds for believing that he or the principal has, a presently exercisable and unconditional right to vest the securities in the purchaser (section 170 of the *Securities and Futures Ordinance* [SFO]).
- b. The concept of “presently exercisable and unconditional right to vest the securities in the purchaser” is interpreted with some flexibility. For further illustration, see the SFC’s Guidance on Short Selling Reporting and Stock Lending Record Keeping Requirements available at the SFC website.¹⁷

¹⁶ SWIFT stands for Society for Worldwide Interbank Financial Telecommunication.

¹⁷ Securities and Futures Commission. <http://www.sfc.hk/sfcRegulatoryHandbook/EN/displayFileArchServlet?docno=H141>

- c. On-exchange covered short sales (i.e., short-selling orders) in “designated securities” (as designated by the HKSE pursuant to the *Short Selling Regulations* in the Eleventh Schedule to the Listing Rules) are permitted provided that
 - (i) the seller (whether acting as principal or agent) must, at the time of placing a short-selling order, identify it as a short-selling order and provide documentary assurance that the sale is “covered” and
 - (ii) An intermediary who receives a short-selling order must ensure that he has obtained a documentary assurance that the sale is “covered”.
- d. The maximum penalties for contravention of section 170 of the SFO are a fine of HKD100,000 and imprisonment for 2 years.
- e. The Hong Kong Securities Clearing Company (HKSCC) charges a default fee of 0.50% of the market value of failed transactions.

H. Definition of Securities

As far as the legal definition of debt instruments is concerned, for bonds to be listed on the HKSE or cleared through the CMU, they must satisfy the criteria set out in, among others, the Listing Rules¹⁸ and the CMU Service Reference Manual (which is accessible to CMU members only), respectively. A definition of securities is also laid down in the SFO.

1. Definition of “CMU Instruments” in the Central Moneymarkets Unit Service Reference Manual

CMU Instruments are money market and capital market instruments, which are specified in the CMU Service Reference Manual as capable of being held within the CMU Service. CMU Instruments include:

- (i) Asset-backed securities,
- (ii) Equity linked instruments,
- (iii) Fixed-rate certificates of deposit,
- (iv) Government bonds,
- (v) Floating-rate certificates of deposit,
- (vi) Bonds,
- (vii) Fixed-rate notes,
- (viii) Floating-rate notes,
- (ix) Commercial papers,
- (x) Mortgage-backed securities,
- (xi) Fixed-rate linked securities,
- (xii) Floating-rate linked securities,
- (xiii) Zero coupon certificates of deposit,
- (xiv) Zero coupon notes,
- (xv) Bills of Exchange other than trade bills, and
- (xvi) Any other Hong Kong dollar money market and capital market instruments as the HKMA may specify from time to time

¹⁸ Footnote 3. http://www.hkex.com.hk/eng/rulesreg/listrules/mbrules/vol1_4.htm

2. Definition of “Securities” in the *Securities and Futures Ordinance* and the Listing Rules

a. Section 1 of Part 1 of Schedule 1 to the *Securities and Futures Ordinance*

“Securities” means

- (i) shares, stocks, debentures, loan stocks, funds, bonds or notes of, or issued by, a body, whether incorporated or unincorporated, or a government or municipal government authority;
- (ii) rights, options or interests (whether described as units or otherwise) in, or in respect of, such shares, stocks, debentures, loan stocks, funds, bonds or notes;
- (iii) certificates of interest or participation in, temporary or interim certificates for, receipts for, or warrants to subscribe for or purchase, such shares, stocks, debentures, loan stocks, funds, bonds or notes;
- (iv) interests in any collective investment scheme;
- (v) interests, rights or property, whether in the form of an instrument or otherwise, commonly known as securities;
- (vi) interests, rights or property which are interests, rights or property, or are of a class or description of interests, rights or property, prescribed by notice under section 392 of the SFO as being regarded as securities in accordance with the terms of the notice;
- (vii) a structured product that does not come within any of paragraphs (i) to (vi), but in respect of which the issue of any advertisement, invitation or document that is or contains an invitation to the public to do any act referred to in section 103(1)(a) of the SFO is authorized or required to be authorized, under section 105(1) of the SFO,

but does not include–

- (1) shares or debentures of a company that is a private company within the meaning of section 29 of the CO (Cap 32);
- (2) any interest in any collective investment scheme that is -
 - (A) a registered scheme as defined in section 2(1) of the *Mandatory Provident Fund Schemes Ordinance* (Cap 485), or its constituent fund as defined in section 2 of the *Mandatory Provident Fund Schemes (General) Regulation* (Cap 485 sub. leg. A);
 - (B) an occupational retirement scheme as defined in section 2(1) of the *Occupational Retirement Schemes Ordinance* (Cap 426); or
 - (C) a contract of insurance in relation to any class of insurance business specified in the First Schedule to the *Insurance Companies Ordinance* (Cap 41);

- (3) any interest arising under a general partnership agreement or proposed general partnership agreement unless the agreement or proposed agreement relates to an undertaking, scheme, enterprise or investment contract promoted by or on behalf of a person whose ordinary business is or includes the promotion of similar undertakings, schemes, enterprises or investment contracts (whether or not that person is, or is to become, a party to the agreement or proposed agreement);
- (4) any negotiable receipt or other negotiable certificate or document evidencing the deposit of a sum of money, or any rights or interest arising under the receipt, certificate or document;
- (5) any bill of exchange within the meaning of section 3 of the *Bills of Exchange Ordinance* (Cap 19) and any promissory note within the meaning of section 89 of that ordinance;
- (6) any debenture that specifically provides that it is not negotiable or transferable (excluding a debenture that is a structured product in respect of which the issue of any advertisement, invitation or document that is or contains an invitation to the public to do any act referred to in section 103(1)(a) of the SFO is authorized, or required to be authorized, under section 105(1) of the SFO);
- (7) interests, rights or property which are interests, rights or property, or are of a class or description of interests, rights or property, prescribed by notice under section 392 of the SFO as not being regarded as securities in accordance with the terms of the notice;

b. Section 7 of Part 1 of Schedule 1 to the Securities and Futures Ordinance

In the SFO, a reference to securities (however described) as those of a corporation shall, unless the context otherwise requires, be construed as a reference to securities (having the applicable meaning, whether under section 1 of Part 1 of Schedule 1 to the SFO or otherwise) which are –

- (i) issued, made available or granted by the corporation;
- (ii) proposed to be issued, made available or granted by the corporation; or
- (iii) proposed to be issued, made available or granted by the corporation when it is incorporated.

c. Rule 1.01 of Chapter 1 of the Rules Governing the Listing of Securities on The Stock Exchange of Hong Kong

- (i) “Debt securities” means debenture or loan stock, debentures, bonds, notes and other securities or instruments acknowledging, evidencing or creating indebtedness, whether secured or unsecured and options, warrants or similar rights to subscribe or purchase any of the foregoing and convertible debt securities.

- (ii) “Equity securities” means shares (including preference shares and depository receipts), convertible equity securities and options, warrants or similar rights to subscribe or purchase shares or convertible equity securities, but excluding interests in a collective investment scheme.

I. Self-Governing Rules behind the Market

Self-governing rules are not applicable in the Hong Kong context.

J. Bankruptcy Procedures

Any bond issuers declaring bankruptcy are subject to the relevant rules set out in the *Bankruptcy Ordinance* (Chapter 6 of the Laws of Hong Kong).

The ranking of a bond vis-à-vis other indebtedness of the bond issuer is determined taking into account the terms and conditions set out in the prospectus, offer documents, term sheets, or similar form of documents as well as section 38 (Priority of Debts) of the *Bankruptcy Ordinance*.

“The Asia-Pacific Restructuring and Insolvency Guide 2006” provides more information on the restructuring and insolvency frameworks of Asia-Pacific countries. The report on Hong Kong, China can be found in the Asian Development Bank (ADB) website.¹⁹

The insolvency law in Hong Kong, China is contained in the CO, the *Bankruptcy Ordinance* and the *Companies (Winding-up) Rules*. It is based on the law of the United Kingdom (UK), prior to the introduction of the Cork Report. Like the regimes in Australia and New Zealand—also UK law-based jurisdictions—it is generally creditor friendly.

Out-of-court restructuring, schemes of arrangement, compulsory liquidations, creditors’ voluntary liquidations, and receiverships are available under the insolvency law. No corporate rescue procedure is currently available.

K. Meetings of Bondholders

1. Resolution of a Meeting of Bondholders

The terms on the rights to convene meetings of bondholders and quorum requirements may be stated in the trust deed or the fiscal agency agreement, and depend on the agreement of the parties.

a. Fiscal Agent Structure

- (i) The issuer or noteholders holding not less than 10% in nominal amount of the bonds for the time being outstanding may convene a meeting of noteholders.

¹⁹ Asian Development Bank. 2006. *The Asia-Pacific Restructuring and Insolvency Guide 2006*. Malaysia: Shearn Delamore & Co. and PricewaterhouseCoopers.

- (ii) The quorum is one or more persons holding or representing not less than 50% in nominal amount of the notes for the time being outstanding.
- (iii) An example of a fiscal agent structure is Swire Pacific MTN Financing and Swire Properties Offshore Financing's USD3.5 billion MTN program dated 18 October 2010.

b. Trustee Structure

- (i) Noteholders holding not less than 10% in principal amount of the notes for the time being outstanding may convene a meeting of noteholders.
- (ii) The quorum is two or more persons holding a clear majority in principal amount of the notes for the time being outstanding (except where the business of the meeting covers certain "reserved matters", a higher threshold is required).
- (iii) An example of a trustee structure is the Standard Chartered/Standard Chartered Bank/Standard Chartered Bank (Hong Kong) /Standard Chartered First Bank Korea USD35 billion debt issuance program dated 10 November 2010.
- (iv) Resolutions passed in a meeting of bondholders, or simply written resolutions of holders holding a specified percent of aggregate principal amount of outstanding bonds, would be binding on all holders of the bonds.
- (v) Usually any changes to the terms would have to be agreed to by the issuer. Bondholders' meetings are generally only convened by the issuer.

2. Appointment of a Trustee

There is no mandatory requirement for the appointment of a trustee to represent the interests of bondholders in Hong Kong. The most common structure for bond issues is the fiscal agent structure with the issuing-cost consideration for the issuers.

Protection of bondholders and representation of their interests are discussed above.

L. Event of Default

1. Terms of Events of Default

Events of default are a matter of negotiation but, generally, cover non-payment of principal or interest by the issuer; non-compliance with obligations under the bond instruments; non-payment of other indebtedness of the issuer or guarantor when due; and the occurrence of certain specified events, for example, change of control, commencement of proceedings against the issuer, passing of an effective resolution for the winding up, administration or dissolution of the issuer or guarantor.

Events of default are usually found in the trust deed, fiscal agency agreement, or deed of covenant (executed by the issuer and guarantor).

2. Declaration of Default

a. Fiscal Agent Structure

Noteholders may give written notice to the issuer to declare that the notes would become forthwith due and payable. This direct right is contained in a deed of covenant.²⁰

b. Trustee Structure

The trustee may, at its discretion, give notice of default by:

- (i) Declaring the notes immediately due and repayable (with a certified opinion that the event is materially prejudicial to the interests of the holders of the notes); or
- (ii) If so directed in writing by the holders of at least 25% in principal amount of the notes, or by an extraordinary resolution of the holders of the notes, declaring all the notes immediately due and repayable.

The trustee may institute proceedings against the issuer to enforce repayment of the principal of the notes with accrued interest and to enforce the provisions of the trust deed. However, the noteholders are not entitled to proceed directly against the issuer unless the trustee fails to do so within a reasonable period and such failure is continuing. The noteholders' interests are represented by the trustee.²¹

c. Event of Default

The default may happen at any time during the day.

M. Options Available on the Bond Market

1. Currency

The most common currencies in which bonds are denominated are Hong Kong dollar, renminbi, US dollar, and euro. The CMU Service is linked to the Hong Kong dollar, US dollar, euro and renminbi RTGS settlement systems in Hong Kong to provide real-time DVP capability for settlement of debt securities denominated in these currencies.

2. Convertible Bonds

As far as convertible bonds are concerned, the issuer will engage a Conversion Agent, who is responsible for handling on behalf of the issuer the conversion notices sent by the bondholders, receiving payments from bondholders and the issuer in respect of the conversion, and cancelling the original bonds upon conversion.

The Conversion Agent will also be responsible for calculating the number and aggregate principal amount of new shares to which the bondholders exercising the conversion rights will be entitled.

The Conversion Agent is normally a bank.

²⁰ See Swire Pacific MTN Financing and Swire Properties Offshore Financing's USD3.5 billion MTN program dated 18 October 2010.

²¹ See MTR Corporation's USD3 billion debt issuance program dated 16 November 2010.

3. Retail Bonds

Retail bonds are usually represented by a single global bond certificate issued in a principal amount equal to the total principal amount of the bond units issued. The placing banks will hold these bonds in their securities accounts with the CMU Service for and on behalf of individual investors.

CMU Account holders are treated as the bondholders. Interest and principal payments will be made to the CMU Account holders (i.e., the placing banks).

Individual investors hold their interests only indirectly in book-entry form through the securities accounts they hold with the placing banks. Individual investors have to rely on the placing banks to ensure that payments are credited to their securities or investment accounts with the placing banks. Individual investors also have to rely on CMU Participants to enforce any rights against the issuer on their behalf.

Where the bonds are listed, the bonds may be traded on the Exchange. Where the bonds are not listed, secondary markets may be established between the placing banks.

An issue of bonds to the public is required to comply with the prospectus requirements under the CO (Cap. 32), including the contents as specified in Third Schedule to the CO, and the offer of investments regime under the SFO (Cap. 571).

An example of such case is the Bank of China Limited retail 2.65% and 2.90% renminbi bonds due on 2012 or 2013 dated 7 September 2010, which adopted the fiscal agent structure.

N. Parties in a Bond Issue and Their Respective Roles

1. Issuer
2. Guarantor
3. The CMU and its appointed sub-custodian for safekeeping of physical global notes
4. Trustee, Paying Agent and/or Fiscal Agent
 - a. The trustee, paying agent and/or fiscal agent are responsible for paying the interest and principal under, and sending notices pursuant to, the notice provisions of the CMU Instruments.
 - (i) The Paying Agent receives an Issue Position Report from the CMU Service on the interest payment dates of the relevant CMU Instruments, the aggregate nominal value of the relevant CMU Instrument held by each CMU Member based on the Interest Payment Record Date, the maturity date of the relevant CMU Instruments, the aggregate nominal value of the relevant CMU Instrument held by each CMU Member based on the Maturity Record Date.
 - (ii) The CMU Member is responsible for further distributing interest payments received from the paying agent to beneficial holders of the bonds.

- b. They are also responsible for organizing and holding meetings of bondholders.

5. CMU Member and/or CMU Lodging Agent

The CMU Member or CMU Lodging Agent holds the legal title of the bonds held within the CMU Service.

With regard to payment of interest, if the CMU Member holds the CMU Instrument for and on behalf of its customers, it should arrange for the relevant amount of interest to be paid to the customers according to the standing arrangements between the CMU Member and the customers.

The CMU Member or CMU Lodging Agent receives the Account Position Report, confirming the balances in their securities accounts with the CMU Service.

CMU Membership is open to members of the Asia Capital Markets Association,²² “authorised institutions” under the *Banking Ordinance* of Hong Kong, China and local and overseas financial entities at the discretion of the HKMA. All CMU Members are required to sign a CMU Membership Agreement with the CMU Service.

- 6. Arrangers
- 7. Dealers
- 8. Legal advisers
- 9. Auditors
- 10. CMU Service
- 11. Participating banks of the respective RTGS settlement systems

O. Major Participants in the Market

1. Issuers

The HKMA is the main issuer of Hong Kong-dollar debt instruments, followed by non-MDB overseas borrowers and authorized institutions.

In 2009, the amount of Exchange Fund Bills issued by the HKMA amounted to HKD1,048 billion, which accounted for 84% of the aggregate amount of Hong Kong-dollar debt instruments issued by any party. Such portion was exceptionally high in 2009 due to the reasons set out in part IX of this report on “History of Debt Market Development”.

²² Established in 1986, the Hong Kong Capital Markets Association (HKCMA) is an industry association founded by a group of financial institutions active in the Hong Kong market to help promote the development of the local and regional debt capital markets. Since its inception, the HKCMA has performed four main functions: i) Providing various professional recommendations and feedback to regulators with respect to developmental issues of the debt markets; ii) Providing a forum for market professionals to discuss and implement best practices guidelines; iii) Organizing regular functions for market participants to network; iv) Providing bond market education and training to the public. <http://www.hkcma.org/>

In other typical years, the HKMA was still the main issuer and accounted for around 50% of total Hong Kong-dollar debt instruments issued. As of the end of 2009, the outstanding amount of bonds issued by public entities including the Government, the HKMA, statutory bodies, and government-owned corporations accounted for 55%; private entities including authorized institutions, local corporates, MDBs, and non-MDB overseas borrowers accounted for the remaining 45%.

In terms of the domicile of issuers (excluding the HKMA), in 2009, 51% were from Hong Kong, followed by Australia (8%), France (7%), and the UK (4%). In terms of the industry of issuers (excluding the HKMA), financial institutions remained the major issuers in the private sector in 2009, and the utilities industry recorded the highest growth (1,514%) as the base was relatively small in 2008.

2. Investors

Pension funds including the Mandatory Provident Fund schemes, Hong Kong banking institutions, and government-related institutions are the major institutional investors of bonds issued in Hong Kong. However, the breakdown of their investment amounts is not available.

For details, refer to the feature article “Hong Kong-dollar debt-market development in 2009” of the *Quarterly Bulletin* March 2010 issue.²³

²³ Government of Hong Kong SAR. 2010. “Hong Kong-dollar debt-market development in 2009,” *Quarterly Bulletin*. March. http://www.info.gov.hk/hkma/eng/public/qb201003/qb_all_index_new.htm

II. Primary and Secondary Markets Regulatory Framework

A. Hong Kong Market Regulatory Structure

1. Market Entry Requirements

There are no market entry requirements or prior registration for foreign market participants to enable them to commence trading in the Hong Kong bond market.

2. Market Regulatory Bodies

a. Hong Kong Monetary Authority

The Hong Kong Monetary Authority (HKMA) is Hong Kong's de facto central bank. The HKMA was established on 1 April 1993 by merging the Office of the Exchange Fund with the Office of the Commissioner of Banking. Its main functions and responsibilities are governed by the *Exchange Fund Ordinance* and the *Banking Ordinance*, and it reports to the Financial Secretary.

The HKMA is the government authority in Hong Kong responsible for maintaining monetary and banking stability. Its main functions are:

- (i) Maintaining currency stability within the framework of the Linked Exchange Rate System;
- (ii) Promoting the stability and integrity of the financial system, including the banking system;
- (iii) Helping maintain Hong Kong's status as an international financial center, including the maintenance and development of Hong Kong's financial infrastructure; and
- (iv) Managing the Exchange Fund.

The HKMA solely operates the Central Moneymarkets Unit (CMU), which provides clearing, settlement and depository services for both HK dollar-denominated and international debt securities available for trading in the Hong Kong market.

The HKMA has developed external infrastructure linkages with other regional and international central securities depositories (ICSDs) to settle securities lodged with the CMU.

b. Securities and Futures Commission

The principal regulator of Hong Kong's securities and futures market is the Securities and Futures Commission (SFC), which is an independent statutory body established in 1989 by the *Securities and Futures Commission Ordinance* (SFCO). The SFCO and nine other securities and futures-related ordinances were consolidated into the *Securities and Futures Ordinance* (SFO), which came into effect on 1 April 2003.

The SFC is responsible for administering the laws governing the securities and futures market in Hong Kong. Its regulatory objectives as set out in the SFO are:

- (i) to maintain and promote the fairness, efficiency, competitiveness, transparency and orderliness of the securities and futures industry;
- (ii) to promote understanding of the public of the operation and functioning of the securities and futures industry;
- (iii) to provide protection for members of the public investing in or holding financial products;
- (iv) to minimize crime and misconduct in the securities and futures industry;
- (v) to reduce systemic risks in the securities and futures industry; and
- (vi) to assist the Financial Secretary in maintaining the financial stability of Hong Kong by taking appropriate steps in relation to the securities and futures industry.

In addition to regulating the Hong Kong Stock Exchange (HKEx), listed companies and share registrars, the SFC oversees licensed corporations and individuals carrying out the regulated activities listed below²⁴, with a direct relevance for the bond market indicated by an asterisk:

- (i) Dealing in securities*
- (ii) Dealing in futures contracts
- (iii) Leveraged foreign exchange trading
- (iv) Advising on securities*
- (v) Advising on futures contracts
- (vi) Advising on corporate finance*
- (vii) Providing automated trading services*
- (viii) Securities margin financing*
- (ix) Asset management*
- (x) Providing credit rating services*

²⁴ Securities and Futures Commission. <http://www.sfc.hk/sfc/html/EN/aboutsfc/regulate/regulate.html>.

c. Hong Kong Stock Exchanges and Clearing

The Hong Kong Stock Exchanges and Clearing Limited (HKEx) is a recognized exchange controller under the SFO. It owns and operates the only stock exchange and futures exchange in Hong Kong and their related clearing houses, namely Hong Kong Securities Clearing Company (HKSCC), HKFE Clearing Corporation (HKCC), and the SEHK Options Clearing House (SEOCH).

For securities identification, the National Numbering Agency (NNA) appointed the HKEx to assign and update the International Securities Identification Number (ISIN) codes for securities listed on the Stock Exchange of Hong Kong (SEHK) and registered in Hong Kong, China.

For other Hong Kong listed securities registered outside Hong Kong, the ISIN codes assigned and updated by the NNAs or their substitute agencies in the corresponding countries will be used. The ISIN codes are available for ordinary shares, debt securities, warrants and trusts.

SEHK also uses local five-digit codes to identify listed securities.

d. The Stock Exchange of Hong Kong

The Stock Exchange of Hong Kong (SEHK), a wholly-owned subsidiary of HKEx, is a recognized exchange company under the SFO. It operates and maintains a stock market in Hong Kong and is the frontline regulator of Stock Exchange Participants with respect to trading matters and of companies listed on the Main Board and Growth Enterprise Market of the Stock Exchange.

e. Hong Kong Futures Exchange

Hong Kong Futures Exchange (HKFE), a wholly-owned subsidiary of HKEx, is a recognized exchange company under the SFO. It operates and maintains a futures market in Hong Kong and is the frontline regulator of Futures Exchange Participants with respect to trading matters.

f. Clearing Houses

HKSCC, SEOCH and HKCC, wholly-owned subsidiaries of HKEx, are recognized clearing houses for the purposes of the SFO. HKSCC and SEOCH provide services for the clearing and settlement of securities and stock option transactions, respectively, including trades and transactions effected on, or subject to the rules of, the Stock Exchange. HKCC provides services for the clearing and settlement of transactions on the Futures Exchange.

B. Regulation of the Hong Kong Securities Markets

1. Legislative Framework

The key legislations governing the Hong Kong capital market are the SFO and the *Companies Ordinance* (CO). The SFO consolidates and modernizes 10 previous ordinances regulating the securities and futures market. The primary legislation and the subsidiary legislation came into effect on 1 April 2003.

The provisions of the SFO provide the SFC with the ability to, amongst others and so far as reasonably practicable, supervise, monitor and regulate the activities carried on by:

- (a) persons carrying out activities regulated by the SFC under the SFO relating to:
 - (i) dealing in securities and futures contracts;
 - (ii) leveraged foreign exchange trading;
 - (iii) advising on securities, futures contracts and corporate finance;
 - (iv) providing automated trading services;
 - (v) securities margin financing;
 - (vi) asset management; or
 - (vii) providing credit rating services.
- (b) persons carrying out activities regulated by the SFC under certain parts of the CO relating to:
 - (i) prospectuses;
 - (ii) the purchase by a corporation of its own shares; and
 - (iii) a corporation giving financial assistance for the acquisition of its own shares.
- (c) recognized exchange companies (e.g., The Stock Exchange and Hong Kong Futures Exchange).
- (d) recognized exchange controllers (e.g., HKEx).
- (e) recognized clearing houses (e.g., HKSCC, HKCC and the SEOCH).
- (f) recognized investor compensation companies (e.g., Investor Compensation Company).
- (g) persons authorized by the SFC to provide automated trading services.

2. Trading Rights

By law, any person carrying on a business dealing in securities, or carrying on a business dealing in futures contracts in Hong Kong, China, has to be licensed by the SFC or fall within one of the licensing exemptions. In addition, the rules promulgated by the Stock Exchange and Futures Exchange require any person who wishes to trade on or through their respective facilities to hold a Trading Right. The Trading Right confers on its holder the eligibility to trade on or through the relevant exchange. However, holding a Trading Right does not, of itself, permit the holder to actually trade on or through the relevant exchange. To be able to actually trade on or through the relevant exchange, it is also necessary for the person to be registered as a participant of the relevant exchange in accordance with its rules, including those requiring compliance with all relevant legal and regulatory requirements. Stock Exchange Trading Rights and Futures Exchange Trading Rights are issued by the Stock Exchange and Futures Exchange at a fee and in accordance with the procedures set out in their respective rules.

C. Regulations and Rules Related to Issuing Debt Instruments

1. For bonds to be listed on the HKSE, bond issuers should observe, among others, the Listing Rules which set out the qualifications for listing, application procedures and requirements, and listing documents and arrangements. For details, refer to Chapters 22-37 of the Listing Rules.²⁵
2. Issuers of bonds to be listed on the HKSE should also observe the Trading Rules promulgated by the HKEx.²⁶
3. For bonds to be listed on the HKSE, issuers should also observe the requirements, of the Listing Rules, as well as Parts II and XII of the CO, including section 44B.²⁷
4. Save for the above and the specific laws mentioned above on bonds issued by different types of entities, other regulations governing the issuance of listed or non-listed bonds in Hong Kong include the following.
 - (a) Both domestic and foreign entities are eligible to issue debt instruments in Hong Kong.
 - (b) Foreign entities interested in raising funds in Hong Kong should, however, ascertain whether it is permitted under the law of their jurisdictions.
 - (c) If the debt instruments are to be listed on the HKSE, issuers have to comply with the requirements for reporting and disclosure of information as set out in the Listing Rules and other relevant documents of the HKSE.

D. Related Rules and Regulations on Investment in Debt Securities

Unless otherwise stated in the prospectus, offer document, term sheet or similar document, there is no restriction on the types of investors who are eligible for investing in particular debt instruments. Foreign investors, whether institutional or retail, should, however, ascertain whether it is permitted under the law of their jurisdictions.

From intermediaries' point of view, when selling unlisted securities to retail investors, they are required to observe, among others, the Code of Conduct for Persons Licensed by or Registered with the SFC; the Management, Supervision and Internal Control Guidelines for Persons Licensed by or Registered with the SFC; the Frequently Asked Questions on Suitability Obligations issued by the SFC; and, where applicable. Intermediaries which are registered institutions under the supervision of the HKMA are also required to observe the guidelines issued by the HKMA. For details, refer to the HKMA guidelines and the SFC Regulatory Handbook for the Code of Conduct for Persons Licensed by or Registered with the SFC.²⁸

²⁵ Footnote 3. http://www.hkex.com.hk/eng/rulesreg/listrules/mbrules/vol1_4.htm

²⁶ Footnote 3. <http://www.hkex.com.hk/eng/rulesreg/traderules/tradingrules.htm>

²⁷ Footnote 11. <http://www.hkliv.org/eng/hk/legis/ord/32/s44B.html>

²⁸ Footnote 10. http://www.info.gov.hk/hkma/eng/guide/circu_date/20100520e1.pdf; Footnote 18. <http://www.sfc.hk/sfcRegulatoryHandbook/EN/displayFileServlet?docno=H652>

E. Investor Protection

1. Existence of the Non-Mandatory Trustee System

Many issuers are choosing to appoint a fiscal agent. However, trustees have a fiduciary responsibility while a fiscal agent does not. From a foreign institutional investors' point of view, a trustee is a 'safer' option than a fiscal agent.

2. The Investor Compensation Fund

Prior to the enactment of the SFO, there were two separate investor compensation schemes called the Unified Exchange Compensation Fund (UECF) and the Commodity Exchange Compensation Fund (CECF) managed respectively by the SEHK and the Hong Kong Futures Exchange. The CECF wound up in May 2006 and the residual monies were transferred to the Investor Compensation Fund (ICF) subsequently. The UECF is applicable to the claims submitted before 1 April 2003 and no longer covers the claims submitted after that. The prevailing ICF was introduced on 1 April 2003 under the SFO.

The maximum compensation limit for each claimant was pegged at HKD150,000. The main aim of the ICF is to pay compensation to investors (any nationality) who suffer financial losses on account of a default on the part of a licensed intermediary or an authorized financial institution in relation to exchange-traded products in Hong Kong.

The Investor Compensation Company was established for the administration and determination of claims received against the ICF. The main source of income for the ICF is from the Investor Protection Levy imposed on each exchange-traded product transaction. The current levy is as follows:

Table 2.1 Current Levy on Exchange-Trade Product Transactions

Nature of Transaction	Amount Payable
Securities transactions	0.002% payable by both buyer and seller
Futures contract	HKD0.5 per side of a contract or HKD0.1 per side of a mini contract or stock futures contract
Source: Deutsche Bank AG Domestic Custody Services Market Guide Hong Kong, October 2009.	

A levy trigger mechanism came into effect on 28 October 2005. As the net asset value of the compensation fund exceeded the limit of HKD1.4 billion in 2005, the payment of Investor Compensation Levy has been suspended by the SFC according to the levy trigger mechanism beginning on 19 December 2005. Other funding sources of ICF include investment income, bank interest earned on deposits maintained, and transfers from the UECF and CECF.

F. Taxation Framework and Tax Requirements

Residents and non-residents investing in the Hong Kong, China market are not charged with withholding tax on dividends and fixed income. Interest income derived from bond holding is not taxable for individuals. For corporations, interest on bonds

issued by the government and government-related entities is not taxable. Other interest is taxable if it has a Hong Kong source. Thus, interest on a corporate bond listed on the HKSE is taxable.

Currently, full exemption from profits tax for interest income and trading profits in respect of certain debt instruments is granted under section 26A of the *Inland Revenue Ordinance*.²⁹ These debt instruments include, inter alia, long-term debt instruments with an original maturity of not less than 7 years.

In addition, pursuant to section 14A of the *Inland Revenue Ordinance* (IRO), a tax concession at 50% of the normal profits tax rate is applied to interest income and trading profits derived from a debt instrument which satisfies the relevant criteria including the following:

- (i) it is lodged with and cleared by the CMU operated by the HKMA;
- (ii) it has an original maturity of not less than 3 years but less than 7 years;
- (iii) it has a minimum denomination of HKD50,000 or its equivalent in a foreign currency;
- (iv) it is issued to the public in Hong Kong, China; and
- (v) it is issued by a person and has, at all relevant times, a credit rating acceptable to the HKMA from a credit rating agency recognized by the HKMA.

Residents and non-residents investing in the Hong Kong market are charged no withholding tax on dividends and fixed income interest.

Table 2.2 Duties and Taxes in the Hong Kong Market

Duties and Tax	
Withholding Tax (WHT)	
WHT – Equities	NIL, except for withholding tax on US Securities traded under the NASDAQ Pilot Program.
WHT - Fixed Income	Nil.
Capital Gains	Nil
Stamp Duty	Stamp duty on Stock Exchange Transactions: 0.1% of the value of the transaction on both the buyer and the seller. Stamp duty on Contract Notes: HKD1 for every HKD1,000 and part thereof on the transaction value.
Other Taxes	Stamp duty on Stock Exchange Transactions: 0.1% of the value of the transaction on both the buyer and the seller. Stamp duty on Contract Notes: HKD1 for every HKD1,000 and part thereof on the transaction value.
Source: Deutsche Bank AG Domestic Custody Services Market Guide Hong Kong, October 2009.	

1. Withholding Tax

There is no withholding tax on dividends and the interests in Hong Kong, China.

2. Tax Treaties (Double Taxation Avoidance)

Hong Kong, China has entered into a very limited number of Double Taxation Avoidance (DTA) treaties. However, since there is no withholding tax on bond interest

²⁹ Footnote 11. <http://www.hkllii.org/eng/hk/legis/ord/112/s26A.html>

and dividends, DTAs may not be relevant in this content. Investors are, however, advised to check their tax position with a qualified tax advisor.

3. Stamp Duty

The following stamp duties are applicable on securities traded in Hong Kong, China.

- (a) Stamp duties and transaction levies are payable on transactions by both buyer and seller. The stamp duty is charged at 0.1% of the consideration by the Inland Revenue Department of Hong Kong on both the buyer and the seller. Any fraction in ad valorem stamp duty will be rounded up to the nearest HKD1.
- (b) A transfer stamp duty must be paid by the seller on transactions for securities which are physically settled and not cleared by the Central Clearing and Settlement System (CCASS). This transfer stamp duty is charged at the rate of HKD5 per Transfer Deed by the Inland Revenue Department of Hong Kong, China.

For trades executed on HKEx, the stamp duty is included in the contract note issued by the broker. The broker pays ad valorem stamp duty on behalf of their clients on T+2. It is the responsibility of the investor to ensure that stamp duty is paid at the correct rate; otherwise, severe penalties can be imposed for non-payment of stamp duty under the *Stamp Duty Ordinance*. As per the *Stamp Duty Ordinance*, on change in the beneficial ownership of shares, ad valorem stamp duty is payable:

- (i) Within 2 days for trades (on exchange or off-market) executed in Hong Kong, China.
- (ii) Within 30 days for off-market trades executed outside Hong Kong, China.

4. Capital Gains Tax

There is no capital gains tax in Hong Kong, China.

5. The Qualifying Debt Instrument Scheme

An active and diverse debt market is important to the further development of Hong Kong as an international financial center. The Qualifying Debt Instrument (QDI) scheme was formulated with the policy intention of developing and enhancing the competitiveness of the local debt market. For the QDI scheme to achieve its policy intention, enhancements need to be introduced from time to time in response to the changing market landscape and measures adopted by other financial centers in the region for developing their respective debt markets.

Interest income and trading profits of debt instruments issued and traded in Hong Kong are chargeable to profits tax under the IRO as stated above.

Currently, a 100% exemption from profits tax for interest income and trading profits arising from certain categories of debt instruments is granted pursuant to section 26A of IRO as stated above. These debt instruments include government bonds, Exchange Fund debt instruments, Hong Kong dollar-denominated multilateral agency debt instruments, and long-term debt instruments with an original maturity of 7 years or longer. In addition, under section 14A of IRO, a tax concession at 50% of the normal profits tax rate is applied to interest income and trading profits derived from a debt instrument that satisfies the relevant criteria stated in page 28.

Notwithstanding the refinements introduced to the QDI scheme in 1999 and 2003, respectively, the percentage of QDI issuance in Hong Kong's total debt issuance remained small. Only 4% of Hong Kong's total debt issuance has been subject to QDI issuance since the last refinement in 2003. There is still room for improving the scheme to enable it to better serve its policy objectives.

The government conducted a review of the QDI scheme and identified several areas for improvement. First, the structure of the tax incentives in the scheme does not match the landscape of Hong Kong's corporate bond market. While Hong Kong's corporate bond market is dominated by privately-placed short-term debt instruments with an original maturity of less than 3 years (46% of total issuance), the scheme only offers tax incentives to debt instruments with an original maturity of 3 years or more and which are "issued to the public".

Second, since the "issued to the public" criterion is not clearly defined in the IRO, there were uncertainties in the market about how such criterion should be interpreted in practice. In addition, the eligibility criteria of the scheme appeared to be more stringent than those of similar schemes in other financial centers in the region.

To address these issues, the government proposed to make enhancements to the QDI scheme. These measures, which aim to strike a balance between meeting market development needs and minimizing the risk of tax avoidance, are expected to help further develop the local debt market and put Hong Kong, China on a more equal footing with other financial centers in the region in attracting debt market activities.

6. Extending Tax Concession to Short-Term Debt Instruments

With the passing of the Inland Revenue (Amendment) Ordinance No. 4 in March 2011, the government extended the 50% tax concession previously granted under section 14A of the IRO to interest income and trading profits derived from debt instruments with an original maturity of less than three years.

At the same time, the Amendment Ordinance clarified the "issued to the public" criteria as issuance to more than 10 persons, or that if issued to less than 10 persons, none of the investors can be a party related to the issuer.

The enhancements to the QDI scheme aim to strike a balance between meeting the market development needs and minimising the risk of tax avoidance, and to place short-term debt instruments on a level-playing field with longer-term debt instruments in respect of profits tax treatment. The changes are expected to help stimulate new demand for bond issues in Hong Kong, China.

G. Offers of Bonds to Professionals

Generally, an offer to sell bonds to professional investors (as defined below) is not required to comply with the prospectus requirements in the CO (Paragraph 1 of Schedule 17 to the CO). This is contrasted with a general offer of bonds to the public, which has to comply with a prospectus requirements in the CO.

A “professional investor” includes any authorized financial institution, any recognized exchange company, recognized clearing house, any authorized insurer, any investment services intermediary, collective investment scheme, any government institution that performs the functions of a central bank, and any person of a class which is prescribed by rules under section 397 of the SFO (section 1 of Part 1 of Schedule 1 to the SFO).

A “prospectus” means any prospectus, notice, circular, brochure, advertisement or other document offering any shares or debentures in a company to the public for subscription or purchase for cash or other consideration; or calculated to invite such offers, with certain exceptions, for example, prospectus that relates to an offer to sell bonds to professional investors (as discussed above).

For offers of bonds listed on the exchange markets, there are set of modified rules for listing application for issues of selectively marketed securities on the HKSE (chapter 37 of the Listing Rules). The requirements are relaxed compared to the rules for listing of debt securities in general in chapters 24-26 (e.g., shorter period of audited accounts and longer period between listing document and latest financial period in the latest audited accounts).

To qualify as “selectively marketed securities”, the offer and sale of the bonds is restricted so that they are marketed to or placed with any number of registered dealers or financial institutions either with a view of reselling such securities as principals off-market—the bonds are of such a nature that nearly all of them will normally be purchased and traded by a limited number of investors who are particularly knowledgeable in investment matters—or placing such bonds with a limited number of such investors.

H. Definition of “Professional Investors” in the Hong Kong, China

1. Section 1 of Part 1 of Schedule 1 to the Securities and Futures Ordinance

“Professional investor” means -

- (a) any recognized exchange company, recognized clearing house, recognized exchange controller or recognized investor compensation company, or any person authorized to provide automated trading services under section 95(2) of the SFO;
- (b) any intermediary, or any other person carrying on the business of providing investment services and regulated under the law of any place outside Hong Kong, China;
- (c) any authorized financial institution, or any bank which is not an authorized financial institution but is regulated under the law of any place outside Hong Kong; China;
- (d) any insurer authorized under the *Insurance Companies Ordinance* (Cap 41), or any other person carrying on insurance business and regulated under the law of any place outside Hong Kong, China;

- (e) any scheme which -
 - (i) is a collective investment scheme authorized under section 104 of the SFO; or
 - (ii) is similarly constituted under the law of any place outside Hong Kong, China and, if it is regulated under the law of such place, is permitted to be operated under the law of such place, or
 - (iii) any person by whom any such scheme is operated;
- (f) any registered scheme as defined in section 2(1) of the *Mandatory Provident Fund Schemes Ordinance* (Cap 485), or its constituent fund as defined in section 2 of the *Mandatory Provident Fund Schemes (General) Regulation* (Cap 485 sub. leg. A), or any person who, in relation to any such registered scheme, is an approved trustee or service provider as defined in section 2(1) of that ordinance, or who is an investment manager of any such registered scheme or constituent fund;
- (g) any scheme which -
 - (i) is a registered scheme as defined in section 2(1) of the *Occupational Retirement Schemes Ordinance* (Cap 426); or
 - (ii) is an offshore scheme as defined in section 2(1) of that Ordinance and, if it is regulated under the law of the place in which it is domiciled, is permitted to be operated under the law of such place, or
 - (iii) any person who, in relation to any such scheme, is an administrator as defined in section 2(1) of that Ordinance;
- (h) any government (other than a municipal government authority), any institution which performs the functions of a central bank, or any multilateral agency;
- (i) except for the purposes of Schedule 5 to the SFO, any corporation which is -
 - (i) a wholly-owned subsidiary of -
 - (A) an intermediary, or any other person carrying on the business of providing investment services and regulated under the law of any place outside Hong Kong, China; or
 - (B) an authorized financial institution, or any bank which is not an authorized financial institution but is regulated under the law of any place outside Hong Kong, China;
 - (ii) a holding company which holds all the issued share capital of -
 - (A) an intermediary, or any other person carrying on the business of the provision of investment services and regulated under the law of any place outside Hong Kong, China; or

- (B) an authorized financial institution, or any bank which is not an authorized financial institution but is regulated under the law of any place outside Hong Kong, China; or
- (iii) any other wholly owned subsidiary of a holding company referred to in subparagraph (ii); or
- (j) any person of a class which is prescribed by rules made under section 397 of the SFO for the purposes of this paragraph as within the meaning of this definition for the purposes of the provisions of the SFO, or to the extent that it is prescribed by rules so made as within the meaning of this definition for the purposes of any provision of the SFO;

2. Section 3 of the Securities and Futures (Professional Investor) Rules (Cap 571D)

For the purposes of paragraph (j) of the definition of “professional investor” in section 1 of Part 1 of Schedule 1 to the SFO (see above), the following persons are prescribed as within the meaning of that definition for the purposes of any provision of the SFO other than Schedule 5 -

- (a) any trust corporation having been entrusted under the trust or trusts of which it acts as a trustee with total assets of not less than USD40 million or its equivalent in any foreign currency -
 - (i) as stated in the most recent audited financial statement prepared -
 - (A) in respect of the trust corporation; and
 - (B) within 16 months before the relevant date;
 - (ii) as ascertained by referring to one or more audited financial statements, each being the most recent audited financial statement, prepared-
 - (A) in respect of the trust or any of the trusts; and
 - (B) within 16 months before the relevant date; or
 - (iii) as ascertained by referring to one or more custodian statements issued to the trust corporation -
 - (A) in respect of the trust or any of the trusts; and
 - (B) within 12 months before the relevant date;
- (b) any individual, either alone or with any of his associates on a joint account, having a portfolio of not less than USD8 million or its equivalent in any foreign currency -
 - (i) as stated in a certificate issued by an auditor or a certified public accountant of the individual within 12 months before the relevant date; or

- (ii) as ascertained by referring to one or more custodian statements issued to the individual (either alone or with the associate) within 12 months before the relevant date;
- (c) any corporation or partnership having -
 - (i) a portfolio of not less than USD8 million or its equivalent in any foreign currency; or
 - (ii) total assets of not less than USD40 million or its equivalent in any foreign currency,
 as ascertained by referring to -
 - (iii) the most recent audited financial statement prepared -
 - (A) in respect of the corporation or partnership (as the case may be); and
 - (B) within 16 months before the relevant date; or
 - (iv) one or more custodian statements issued to the corporation or partnership (as the case may be) within 12 months before the relevant date; and
- (d) any corporation the sole business of which is to hold investments and which is wholly owned by an individual who, either alone or with any of his associates on a joint account, falls within the description in paragraph (b).

I. Challenges and Expected Changes

1. Consultation on Market only for Professional Investors

The HKEx is undergoing market consultation on some proposed changes to the requirements for the listing of debt issues to professional investors only. The proposed changes include, but are not limited to the following:

- (a) to unify the definition of professional investors in the Listing Rules with the definition in the SFO stated above;
- (b) to replace the current detailed disclosure requirements with an obligation to include information that is customary for offers of debt securities to professionals, as there is perception that listing in Hong Kong, China is more document intensive than other jurisdictions such as Singapore; and
- (c) To streamline the application procedures.

For details, refer to the Consultation Paper on Proposed Changes to Requirements for the Listing of Debt Issues to Professional Investors Only published at the HKEx website.³⁰ For updates on market consultations, updated Responses to Consultation

³⁰ Footnote 3. <http://www.hkex.com.hk/eng/newsconsul/mktconsul/Documents/cp2010122.pdf>; <http://www.hkex.com.hk/eng/newsconsul/mktconsul/Documents/cp2010122q.doc>

and Consultation Conclusions Proposed Changes to Requirements for the Listing of Debt Issues to Professional Investors Only (October 2011), see the HKEx website as well.³¹

2. Enhancement Measures to the Qualifying Debt Instrument Scheme

Regarding the taxation regime, as announced in the Financial Secretary's Budget for 2010-2011, the government will introduce enhancement measures to the QDI scheme.

Specifically, the government will extend the 50% tax concession to interest income and trading profits derived from debt instruments with an original maturity of less than 3 years with a view to encourage a wider spectrum of participants and stimulate new demand for debt instrument issuance activity.

3. Clarification of the "Issued to the Public" Criterion

The government also clarified the "issued to the public" criterion in the IRO to better meet market requirements. The government prepared the legislative amendments and introduced the bill in the Legislative Council in the first quarter of 2011.³²

To remove uncertainties concerning what constitutes "issued to the public" as stipulated in paragraph (e) of the definition of "debt instrument" in section 14A(4) of the IRO, the government proposed to replace the "issued to the public" criterion with a new requirement that, at issuance, the instrument is issued in Hong Kong, China to –

- (a) ten or more persons; or
- (b) If less than 10 persons, none of whom is an associate of the issuer of the instrument.

The "issued to the public" criterion was introduced to address potential tax avoidance through arranging as QDIs intra-group or inter-group debt issues that are otherwise not necessary to enjoy tax benefits. However, since the IRO does not specify what constitutes "issued to the public", the legal uncertainties involved have put many debt-market participants off using the QDI scheme.

The proposed amendment was formulated taking into account the landscape of Hong Kong's debt market and the criterion's original intent of preventing tax avoidance. In drawing up the proposal, the government made reference to similar schemes overseas which are considered successful in facilitating the development of the relevant local debt market. For instance, under Singapore's scheme, debt securities are deemed "issued to the public" if they are issued to four persons or more; or have less than 50% of the issue of debt securities being beneficially held or funded by related parties of the issuer of those debt securities at the time of primary launch. If, at any time during the life of an eligible debt issue, 50% or more of the issue is beneficially held or

³¹ Footnote 3. <http://www.hkex.com.hk/eng/newsconsul/mktconsul/marketconsultation.htm>; Responses to Consultation Paper Updated (21 October 2011), <http://www.hkex.com.hk/eng/newsconsul/mktconsul/responses/cp2010122r.htm>; Consultation Conclusions Proposed Changes to Requirements for the Listing of Debt Issues to Professional Investors Only (October 2011), <http://www.hkex.com.hk/eng/newsconsul/mktconsul/Documents/cp2010122cc.pdf>

³² Government of Hong Kong Special Administrative Region. Legislative Council. http://www.legco.gov.hk/yr10-11/english/bills/brief/b21_brf.pdf

funded, directly or indirectly, by a related party of the issuer, the portion of the issue held by related parties will not be eligible for tax concessions under the scheme. On the other hand, under Australia's scheme, issuers are only required to offer the issue to a specified minimum number of potential investors. No requirement is set on the number of investors to whom the debt securities are ultimately issued.

III. Trading of Bonds and Trading Market Infrastructure

Most bond trading is done via the over-the-counter (OTC) market. However, there are various types of debt securities listed on the Hong Kong Stock Exchange (HKEx). These include corporate bonds, convertible bonds, and Exchange Fund Notes. Securities (mainly shares) listed and traded on the HKEx are also in scripless form, and holders of Central Clearing and Settlement System (CCASS) accounts are credited or debited for securities purchased and sold respectively. Besides the above standard securities, Equity Linked Instruments and Exchange Traded Funds are also available for trading on the HKEx.

In December 1993, the Hong Kong Monetary Authority (HKMA) extended their settlement and clearing facilities to debt securities traded on the HKEx. But, as far as the debt securities is concerned, many listed bonds are not traded on the HKEx. Listed bonds are mainly traded in the OTC market and, in some cases, traded on the HKEx; unlisted bonds, on the other hand, are traded in the OTC market.

If bonds are listed and traded on the HKEx, the prevailing bid-and-ask prices, yield-to-maturity, and certain static information such as the bond's coupon rate and maturity date are usually disseminated by the HKEx through information vendors to the market.

Trading of listed debt securities is subject to Trading Rules of the HKEx.³³ For the trading activities of bonds listed on the HKEx, refer to the HKEx Factbook 2009, the Securities and Futures Commission (SFC) Joint Consultation Paper on a Proposed Operational Model for Implementing Scripless Securities Market in Hong Kong, and the SFC Joint Consultation Paper on a Proposed Operational Model for Implementing Scripless Securities Market in Hong Kong.³⁴

³³ Footnote 3. <http://www.hkex.com.hk/eng/rulesreg/traderules/tradingrules.htm>

³⁴ Footnote 3. <http://www.hkex.com.hk/eng/stat/statrpt/factbook/factbook2009/fb2009.htm>; Securities and Futures Commission (SFC). 2010. Joint Consultation Paper on a Proposed Operational Model for Implementing Scripless Securities Market in Hong Kong. <https://www.sfc.hk/sfcConsultation/EN/sfcConsultMainServlet?name=scripless>; SFC. 2010. Joint Consultation Conclusions on a Proposed Operational Model for Implementing a Scripless Securities Market in Hong Kong. http://www.sfc.hk/sfc/doc/EN/speeches/consult/ConsultationConclusions_Paper_Final_Eng.pdf

A. Over-the-Counter Market Trading

If bonds are traded in the OTC market, any interested investors can obtain direct access to relevant information supplied by various financial information providers (e.g., Bloomberg and Reuters), or rely on intermediaries, such as, distributing banks to get such information.

In Hong Kong, China bonds may be held within the Central Moneymarkets Unit (CMU) Service operated by the HKMA in either definitive or global instrument form. The CMU Service provides a central depository service for CMU Instruments held within the CMU Service and an electronic book-entry system for electronic trading between CMU Members of CMU Instruments without physical delivery of CMU Instruments. The bond instruments must be lodged with a sub-custodian appointed by the HKMA. The bond issuer must either be a CMU Member or authorize a CMU Member as a Lodging Agent to use the depository services of the CMU Service.

While the bonds are represented by global notes, the CMU Lodging Agent holds the legal title of these bonds, which are then “immobilized” via the CMU accounts. Holders of CMU accounts hold the bonds in the “Main Account” for their own benefit, and the bonds in the General/Specific Custody Accounts for and on behalf of their own customers.

For bonds held in the General/Specific Custody Accounts, CMU Members would have to refer to their own internal records to ascertain the beneficial ownership of the bonds held in such accounts. The Issuer and the Paying Agent directly make payments of principal, interest or any amounts to the persons for whose accounts interests in the global bond are credited (as set out in a CMU Instrument Position Report, or as notified to the CMU Lodging Agent by the CMU Service). Individual beneficial holders will have to rely on the CMU Member or the CMU Lodging Agent for the delivery of payments and notices to them.

Clearing and settlement of debt securities lodged with the CMU is subject to the Exchange Fund Bills and Notes (EFBN) and CMU Service Reference Manuals (which are accessible by CMU members only) and other relevant documents. Furthermore, for trading activities of bonds lodged with the CMU, refer to the CMU Bond Price Bulletin website, scroll down to “CMU Bond Price Bulletin” section and click the hyperlink, which provides investors with convenient online access to indicative bond prices quoted by major banks and securities firms in Hong Kong, China.³⁵

Some intermediaries with bond trading services will also post bond price information on their websites.

B. Over-the-Counter Market Business Process

The following diagram shows the key infrastructure components as evident in the Hong Kong OTC bond market:

³⁵ Footnote 10. <http://www.info.gov.hk/hkma/eng/infra/index.htm>

Figure 3.1 Bond Settlement Infrastructure in Hong Kong, China

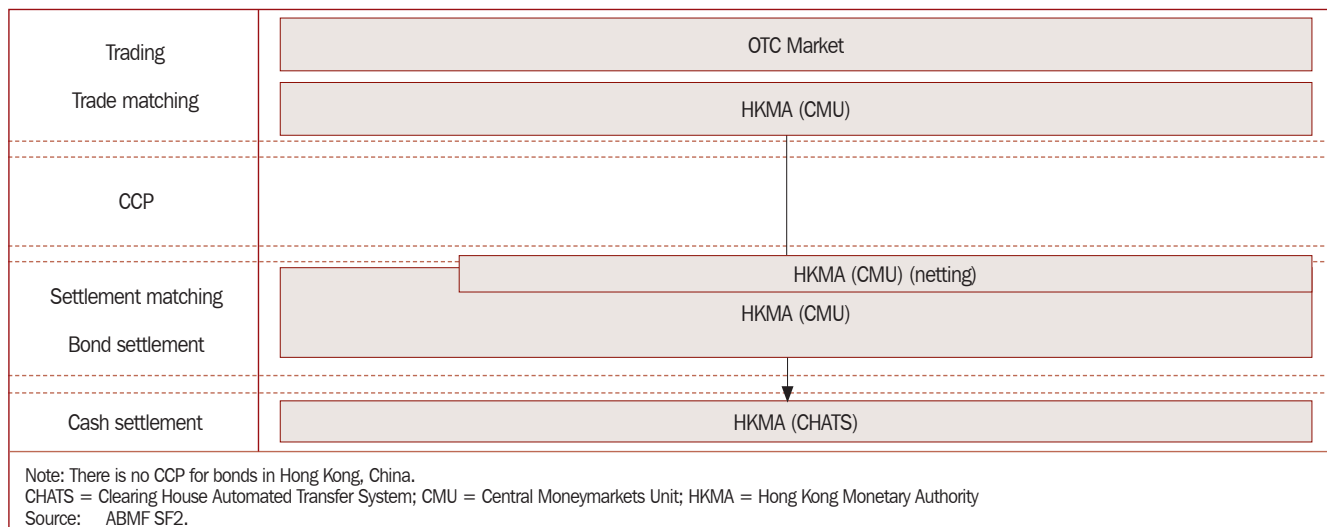

Business Process Flowchart of the Hong Kong Bond Market

The following diagram shows the flow of a typical OTC bond transaction, settled on a delivery-versus-payment (DVP) basis, in the Hong Kong market. The individual steps of the process are explained in detail thereafter.

Figure 3.2 Business Process Flowchart Hong Kong Bond Market (Over-the-Counter Market/Delivery versus Payment)

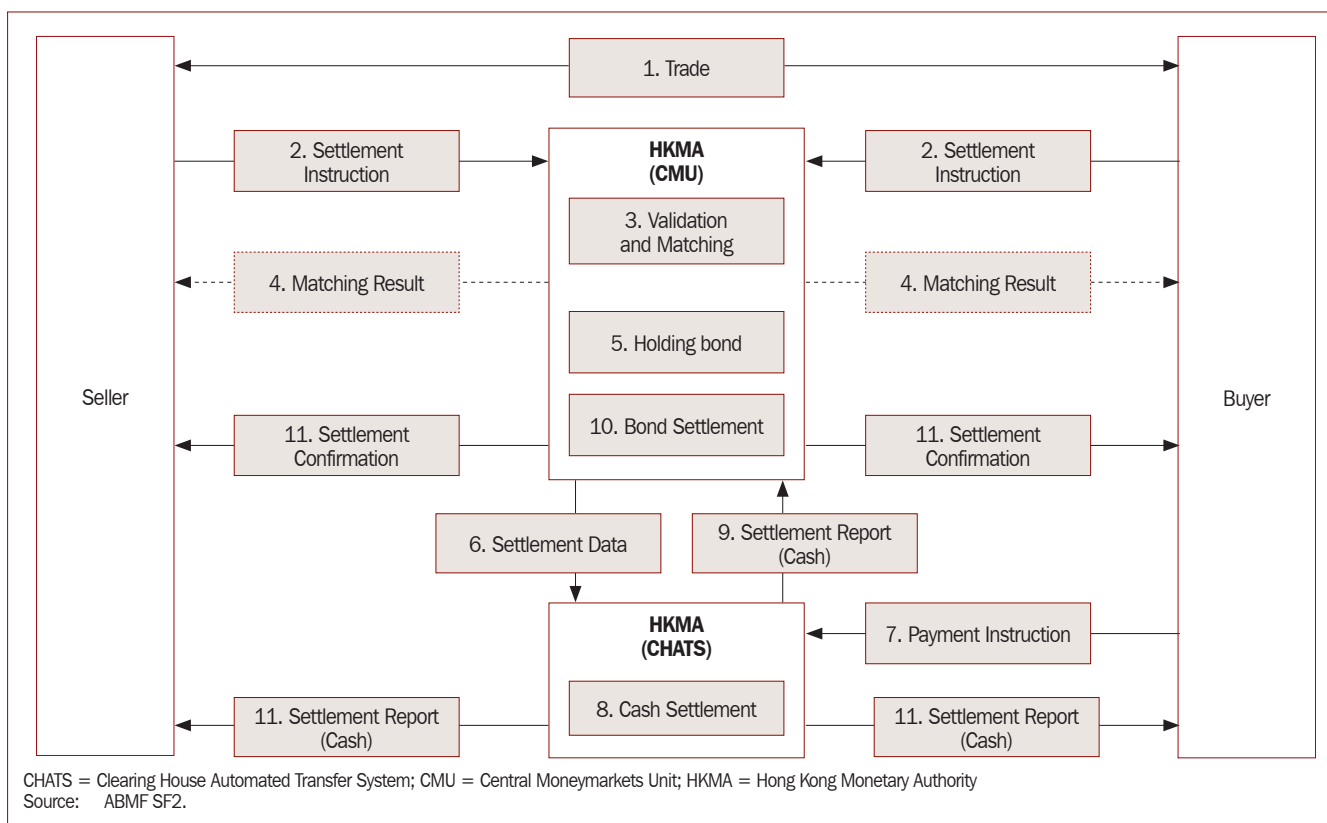

1. Seller and buyer trade over the counter.
2. The seller and buyer send instructions to Central MoneymarketsUnit(CMU) via CMT, SWIFT, Fax, AFT or by hand. When they use system, either seller or buyer enters trade data to be forwarded to the counterpart (buyer or seller). The counterpart can utilize the trade information as a message instruction to be sent to the CMU. Participants need to send the message instructions before the cutoff time (4:00 p.m.) on settlement day.
3. CMU performs validation and matching.
4. CMU sends matching result to the seller and buyer.
5. CMU holds the debt securities.
6. CMU sends settlement data to CHATS.
7. For real time DVP settlement involving non-bank debt securities buyer, the buyer instructs its bank to pay by sending payment instruction to CHATS.
8. CHATS executes cash settlement.
9. CHATS sends cash settlement report to CMU.
10. CMU executes debt securities settlement.
11. CHATS sends cash settlement report to the buyer and seller respectively, while CMU sends securities settlement confirmation to the seller and buyer.

At present, there is no central counterparty (CCP) for the OTC bond market. In this context, clearing effectively refers to a netting service for participants, i.e. in the form of the EOD settlement mode provided by CMU. In effect, 99% of trades are settled in the EOD settlement run.

Matching in the above business process is limited to settlement matching (since trading is not facilitated in CMU itself). Trade matching continues to be conducted between trading counterparties on a purely bilateral basis.

For settlement matching, central matching is supported, by way of two-sided input or the input and affirmation of an alleged trade; this allows trading platforms, such as Bloomberg to send trade details directly into CMU. However, instructions already matched in CMU can still be cancelled between counterparties before settlement.

One noteworthy feature in the CMU system is that blocking of securities positions will only take effect on Settlement Date. This allows settlement instructions with future settlement dates to be captured for up to 30 days prior to settlement date.

In general, the settlement cycle for Exchange Fund papers traded before 11 a.m. Hong Kong time is T+0 (same day settlement), and T+1 for Exchange Fund papers traded after 11 a.m. Hong Kong time. The settlement cycle for other Hong Kong government bonds is usually T+1 or T+2, while for corporate bonds and RMB bonds typically on T+2, in line with the equities market.

CMU supports multiple securities identifiers, including ISIN, CMU Instruments Number, and Common Code. CMU uses MT54x messaging.

C. Hong Kong Bond Transaction Flow (For Foreign Investors)

The following diagram shows the flow of a typical bond transaction in the Hong Kong OTC market from a foreign investor perspective, and settled on a delivery-versus-payment (DVP) basis. The individual steps of the process flow are explained in detail thereafter.

Figure 3.3 Hong Kong Bond Transaction Flow for Foreign Investors

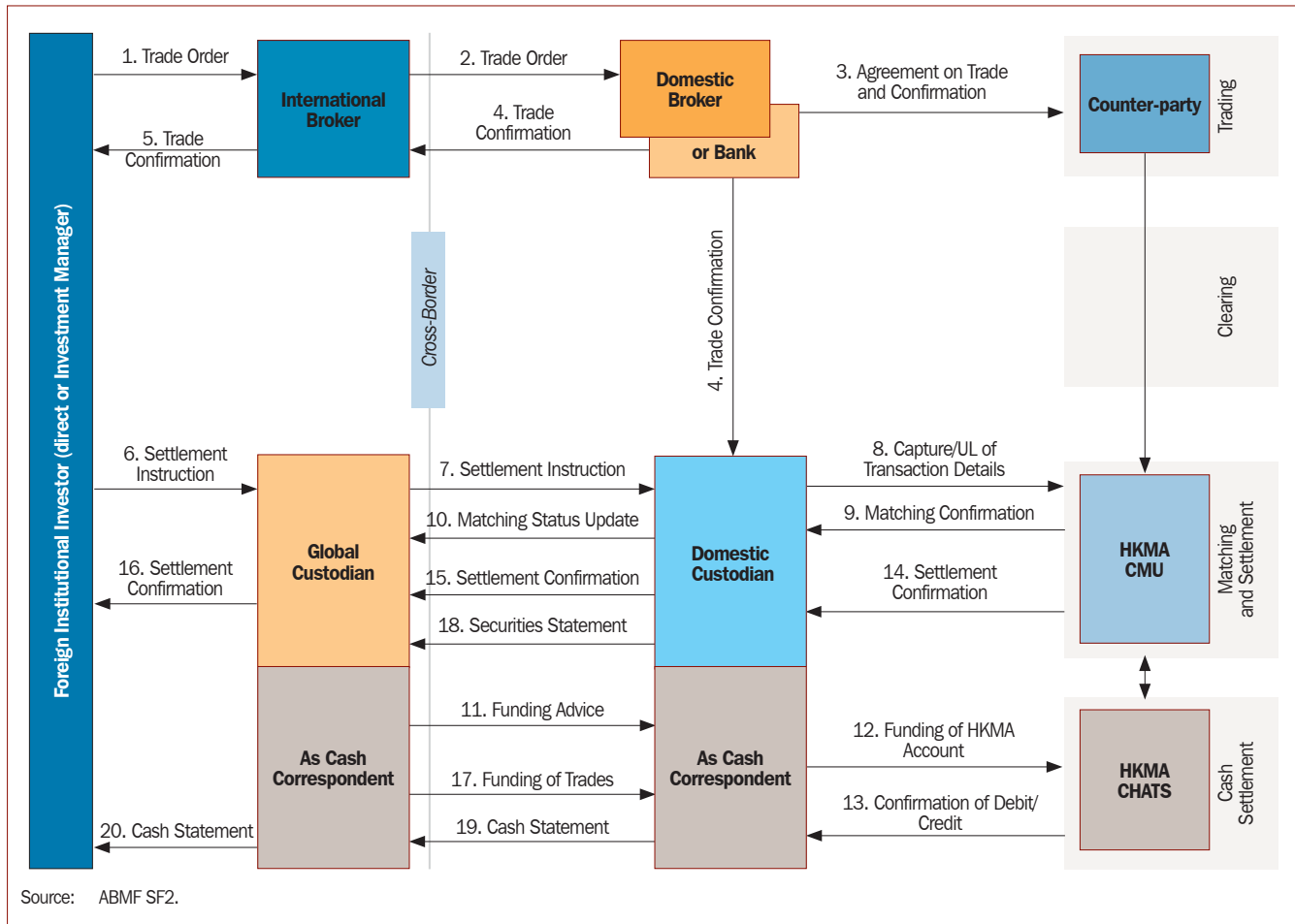

T = Trade Date

T+2 = Settlement Date

Note: Below is the description of the OTC bond transaction flow for foreign investors in Hong Kong, China.

1. Foreign Institutional Investor places order with International Broker.
2. International Broker places order with Domestic Broker/Bank.
3. Domestic Broker/Bank trades over the counter with Counterparty (via phone or, e.g., Bloomberg).
4. Domestic Broker/Bank sends trade confirmation to International Broker.

5. Foreign Institutional Investor receives trade confirmation.
6. Foreign Institutional Investor instructs Global Custodian on securities settlement and cash funding details.
7. Global Custodian instructs Domestic Custodian on securities settlement.
8. Domestic Custodian captures (e-CMU Member Terminal or upload) settlement instructions into Central Moneymarkets Unit (CMU).
9. Domestic Custodian receives transaction matching confirmation from CMU or status updates.
10. Domestic Custodian sends matching status update to Global Custodian, either as a report or, typically, per individual transaction.
11. Global Custodian advises funding details to Domestic Custodian.
12. Domestic Custodian effects funding of Hong Kong Monetary Authority (HKMA) account via the Clearing House Automated Transfer System (CHATS).
13. Upon transfer of cash, HKMA sends cash settlement confirmation to Domestic Custodian.
14. Upon transfer of bonds, CMU sends bond settlement confirmation to Domestic Custodian.
15. Domestic Custodian sends settlement confirmation to Global Custodian.
16. Foreign Institutional Investor receives settlement confirmation from Global Custodian
17. Global Custodian funds trades into Domestic Custodian Hong Kong dollar account, or into foreign currency nostro.
18. Domestic Custodian sends securities statement to Global Custodian.
19. Domestic Custodian sends debit/credit confirmation as cash statement to Global Custodian.
20. Global Custodian sends debit/credit confirmation in cash statement to Foreign Institutional Investor.

IV. Future Developments

This section explores some of the typical areas of improvements for bond markets in ASEAN+3 and reviews the applicability of such potential to the Hong Kong bond market.

A. Repo Market

Banks holding Exchange Fund Bills and Notes (EFBNs) can obtain financing from the Hong Kong Monetary Authority (HKMA) through intraday repo or a discount window. Bank repo with types of eligible debt securities bilaterally agreed by both parties is also supported but the market remains insignificant.

The Central Moneymarkets Unit (CMU) launched enhancements to its bank repo service in November 2011 to support collateral management services. These include daily mark-to-market of collateral values, top-up and return of collateral and collateral substitution.

B. Liquidity in the Secondary Market

In 2009, the CMU processed a daily average value of HKD172 billion (242 transactions) in secondary market transactions. Debt securities traded in the secondary market were dominated by EFBNs, with only a tiny portion of private debt issues being traded. On the other hand, the secondary market of bonds listed on the Hong Kong Stock Exchange (HKSE) was comparatively inactive. In the same year, the aggregate turnover of debt securities traded on the HKSE amounted to HKD3.97 million only.

C. Renminbi-Denominated Bond Market

Bonds issued in Hong Kong, China were mainly denominated in Hong Kong dollars or US dollars before 2007. Since the first renminbi-denominated bonds issued by the China Development Bank in July 2007, the market has seen an increasing number and value of bonds issued in renminbi.

As of the end of October 2011, the total outstanding renminbi bonds lodged with the CMU amounted to RMB196 billion. The aggregate value of renminbi bonds issued in Hong Kong amounted to RMB233 billion.

In addition to financial institutions and the Mainland Government, some multinational corporations such as McDonald's and Caterpillar have also tapped the renminbi bond market in Hong Kong, China. Funds raised by bond issuers can be remitted back to the Mainland in the form of a shareholders' loan or equity capital injection subject to approval of the relevant Mainland authorities. They can also be used for any other purposes outside the Mainland as there is no restriction on the usage of renminbi in the offshore market.

D. Conclusion

Overall, there are no significant impediments that hinder the development and growth of the bond market in Hong Kong, China. Nonetheless, the Government and HKEx have identified some areas for improvement and are undergoing various procedures to put the enhancements in place as soon as practicable.

V. Description of the Securities Settlement System

A. Securities Settlement Infrastructure

1. Central Moneymarkets Unit

The Central Moneymarkets Unit (CMU) is the debt securities clearing and settlement system in Hong Kong, China operated by the Hong Kong Monetary Authority (HKMA). Established in 1990, the CMU provides an efficient clearing, settlement and custodian service for debt securities denominated in Hong Kong dollars and other major currencies. It also provides an electronic book-entry system which eliminates the physical delivery of debt securities between CMU Members. These debt securities include Exchange Fund Bills and Notes (EFBNs), government bonds, and debt securities issued by both public and private sector entities.

In December 1996, a seamless interface between the CMU and Hong Kong dollar real-time gross settlement (RTGS) system was established. Such linkage provides real-time and end-of-day delivery-versus-payment (DVP) services to CMU Members. The CMU was further linked to the RTGS systems of the US dollar in December 2000, the euro in April 2003, and the renminbi in March 2006 to provide real-time DVP capability for debt securities denominated in these currencies, as well as intraday and overnight repo facilities for the respective payment systems in Hong Kong, China.

The CMU has also developed external links with regional central securities depositories and international central securities depositories such as Euroclear and Clearstream. The linkages enable international investors to hold and settle CMU securities through these international networks, and enable investors in Hong Kong, China and other parts of Asia to hold and settle Euroclear and Clearstream debt securities directly in a secure DVP environment via their CMU Members.

In terms of settlement arrangements, if the debt securities are settled using real-time DVP mode, both cash and securities legs are settled on a gross basis. If the debt securities are settled using end-of-day (EOD) DVP mode, both cash and securities are settled on a net basis. Nevertheless, transactions settled at EOD are still completed on a deal-by-deal basis in legal terms. If securities are settled using free-of-payment (FOP) mode, settlement will be done on a gross basis for real-time FOP or net basis for end-of-day FOP.

Besides provision of clearing, settlement and custody services, the CMU also provides a tendering platform to facilitate price discovery and enhance price transparency. In November 2010, the Mainland's Ministry of Finance (CMoF) used the CMU Bid Service for the first time for tendering renminbi sovereign bonds among institutional investors. The tendering attracted a huge number of applications with highly competitive pricing, with the coupon rate of 3-year, 5-year and 10-year issues fixing at 1%, 1.8% and 2.48%, respectively. In August 2011, CMoF made use of the CMU Bid service for the second time to tender renminbi bonds in Hong Kong with coupon rates of 3-year, 5-year, 7-year, and 10-year fixing at 0.6%, 1.4%, 1.94%, and 2.36%, respectively.

The HKMA and the CMU encourage the use of RTGS but can also settle net at EOD. This is available for trades that have passed cut-off time(s). Presently, 90% of trades settle in the EOD mode because counterparties are covering short positions throughout the trading day.

2. Central Clearing and Settlement System

Linkages have also been established between the Central Clearing and Settlement System (CCASS) operated by the HKSE and Hong Kong dollar, US dollar and renminbi RTGS systems. Similar to the settlement arrangements for debt securities lodged with the CMU, settlement of listed debt securities can be done in real-time or end-of-day, DVP or FOP. It should, however, be noted that not all bonds traded on the HKSE are cleared and settled through the CCASS. Some of the listed debt securities are cleared and settled through the CMU. Examples of which include EFBNs issued by the HKMA.

B. Definition of Clearing and Settlement

1. Clearing

Clearing operates after trading and before delivery (or settlement). It involves techniques designed to address the risk of counterparty default after trading and before settlement, primarily through the netting of mutual post-trade obligations of market participants and the use of a well-capitalized intermediary (known as the clearing house). The clearing house assumes the contractual obligations of each party to settle the trade. Even if one party defaults post-trade and pre-settlement, settlement will still go ahead.

Instructions to transfer CMU instruments must be sent to the CMU by the CMU Member Terminals (CMT), SWIFT, by hand, by post, by fax, or by telex. There is no standard clearing services in the capacity of a central counterparty. The transfers are directly made between CMU Members themselves. For that reason, all DVP transactions under the CMU are subject to the credit risk of the settlement banks.

The CMU Service has linkages with Euroclear and Clearstream to enable investors in Hong Kong and overseas to hold and settle Euroclear and Clearstream debt securities directly in a secure DVP environment via their CMU Members.

For listed bonds, the Hong Kong Securities Clearing Company (HKSCC) does not provide any physical depository services in respect of CMU Instruments. However, as a result of clearing and settlement of transactions in CMU Instruments effected on the HKSE, allocation following an application for CMU Instruments made through the CCASS, or the provision of other CCASS services to CCASS Participants, CMU Instruments may be credited to and debited from CCASS Participants' stock accounts.

CCASS is a clearing system for the HKSE. It operates a continuous netting system for netting of holdings of interests in the CCASS securities accounts. As the HKSCC, which is the operator of CCASS, is the central counterparty with which market participants deal directly, they only bear the credit risk of HKSCC, not of the other market participant.

Settlement happens 2 trading days after the date of the transaction on the HKSE.

2. Settlement

Settlement means delivery, usually against payment. Once a trade has taken place, the buyer is contractually bound to deliver the securities to the seller, and the seller is contractually bound to pay the purchase price to the seller. Settlement of securities through electronic systems usually takes the form of synchronized payment and delivery sides of each transaction.

The CMU Service provides the following settlement facilities:

- (i) The CMU Service provides a real-time and end-of-day DVP facility for transactions denominated in Hong Kong dollar, renminbi, euro and US dollar through the RTGS systems. The HKMA, as operator of the CMU Service, matches the debit instruction with the corresponding credit instruction, including information on the settlement date, buyer and seller accounts, issue number, nominal currency and amount, settlement mode, currency and amount. Real-time settlement of the transaction happens immediately once both the payment funds are available from the settlement bank and the seller's securities account holds sufficient securities. It also offers the FOP facility as an alternative.

DVP means delivery of securities simultaneously upon transfer of the funds for payment on a trade-by-trade basis, whereas FOP means delivery of securities with no corresponding payment of funds.

- (ii) Cross-border DVP settlement is effected via regional central securities depositories (CSDs) and international central securities depositories (ICSDs).

C. Challenges/ Expected Changes

The CMU has been functioning smoothly and efficiently, and there are no planned material changes to be applied to the CMU as far as the settlement arrangement is concerned.

VI. Cost and Charging Methods

A. Initial Fees

Refer to Appendix 1 for the CMU tariffs and Appendix 2 for the fee schedule for debt securities listed on the Stock Exchange of Hong Kong (SEHK).

B. Maintenance (Ongoing) Costs

Refer to Appendix 1 for the CMU tariffs and Appendix 2 for the fee schedule for debt securities listed on the HKSE.

The following market charges exist in the Hong Kong, China market.

Table 6.1 Market Charges in the Hong Kong, China Market

Market Charge	Details
Trading Fees	0.005% per side payable by both buyer and seller
Brokerage Fees	Brokerage Commission on SEHK trades is freely negotiable.
Registration Fees	Registration fee of HKD2.50 per certificate is charged by the registrar.
Stock Settlement Fees	Stock settlement fee of 0.002% will be charged on gross settlement amount, subject to a minimum fee of HKD2 and a maximum fee of HKD100 per trade.
Source: Deutsche Bank AG Domestic Custody Services Market Guide Hong Kong, October 2009.	

VII. Market Size and Statistics

A. Market Size

While the issuance of Hong Kong-dollar debt instruments remained relatively stable at around HKD400 billion annually between 1998 and 2008, the outstanding amount steadily increased from HKD393 billion to HKD717 billion over the same period. In 2009, due to the massive capital inflows and an increasing market demand for Exchange Fund Bills issued by the Hong Kong Monetary Authority (HKMA), HKD1,048 billion worth of exchange fund bills were issued, resulting in a substantial increase in the issuance of Hong Kong-dollar debt instruments from HKD424 billion in 2008 to HKD1,242 billion in 2009.

B. The Renminbi Bond Market

On the other hand, the renminbi bond market has recorded a rapid growth since the issuance of the first renminbi-denominated bonds in Hong Kong, China in July 2007. As of October 2011, the aggregate value of renminbi-denominated bonds lodged with the CMU amounted to RMB196 billion. Bond issuers comprised the Mainland Government, financial institutions, and multinational corporations.

C. Debt Issuance and Syndicated Loans vs. Equity Market

Among the different means of fund-raising activities in Hong Kong, China (excluding the issuance of Exchange Fund Bills), the equity market was the most favourite among fund raisers, amounted to HKD427 billion in 2008, accounting for 59% of the aggregate amount of funds raised. On the other hand, the size of Hong Kong-dollar debt issuance was comparable with that of the syndicated loan, with the Hong Kong-dollar debt issuance raising HKD138 billion and syndicated loan raising HKD154 billion in 2008.

For details, refer to the feature article “Hong Kong-dollar debt-market development in 2009” of the March 2010 *Quarterly Bulletin*.³⁶

D. Market Data from *AsianBondsOnline.com*

1. Size of Local Currency Bond Market in Percentage of Gross Domestic Product (Local Sources)

Table 7.1 Size of Local Currency Bond Market in Percentage of Gross Domestic Product (Local Sources)

Date	Govt (in % GDP)	Corp (in % GDP)	Total (in % GDP)	Govt (in USD billions)	Corp (in USD billions)	Total (in USD billions)
Mar-95	5.1	0	5.1	7.05	-	7.05
Jun-95	5.1	0	5.1	7.20	-	7.20
Sep-95	5.2	12.3	17.5	7.36	17.47	24.84
Dec-95	5.3	12.6	17.9	7.60	18.21	25.81
Mar-96	5.3	13.5	18.8	7.83	19.81	27.63
Jun-96	5.4	14.4	19.8	8.05	21.61	29.66
Sep-96	5.4	14.7	20.1	8.29	22.60	30.89
Dec-96	7.5	15.4	22.9	11.88	24.53	36.40
Mar-97	7.5	15.4	23.0	12.29	25.16	37.45
Jun-97	7.5	16.5	24.0	12.66	27.86	40.51
Sep-97	7.4	17.3	24.7	12.90	30.03	42.94
Dec-97	7.4	18.0	25.5	13.12	31.75	44.87
Mar-98	7.6	19.1	26.7	13.35	33.68	47.03
Jun-98	7.8	20.5	28.3	13.58	35.72	49.30
Sep-98	7.4	22.3	29.6	12.58	38.00	50.58
Dec-98	7.5	22.9	30.4	12.58	38.17	50.75
Mar-99	7.6	24.4	32.1	12.57	40.21	52.79
Jun-99	7.8	25.3	33.1	12.74	41.14	53.88
Sep-99	8.0	26.4	34.3	12.92	42.72	55.64
Dec-99	8.0	26.6	34.7	13.11	43.39	56.50
Mar-00	8.0	28.0	36.1	13.29	46.29	59.58
Jun-00	8.1	27.8	35.9	13.49	46.21	59.70
Sep-00	8.2	27.6	35.7	13.70	46.31	60.01
Dec-00	8.2	27.6	35.8	13.92	46.58	60.51
Mar-01	8.4	27.5	35.9	14.12	46.41	60.53
Jun-01	8.5	28.6	37.1	14.3	48.21	62.51
Sep-01	8.6	29.0	37.7	14.45	48.69	63.14
Dec-01	8.8	29.2	38.0	14.59	48.71	63.29
Mar-02	8.9	30.4	39.3	14.7	50.22	64.93
Jun-02	9.0	32.6	41.6	14.84	53.52	68.35
Sep-02	9.1	31.8	40.9	14.94	52.12	67.06
Dec-02	9.2	32.4	41.6	15.06	53.02	68.09
Mar-03	9.3	33.4	42.7	15.16	54.54	69.70

continued on next page

³⁶ HongKongMonetaryAuthority.http://www.hkma.gov.hk/media/eng/publication-and-research/quarterly-bulletin/qb201003/fa1_print.pdf

Table 7.1 continuation

Date	Govt (in % GDP)	Corp (in % GDP)	Total (in % GDP)	Govt (in USD billions)	Corp (in USD billions)	Total (in USD billions)
Jun-03	9.5	34.6	44.2	15.26	55.55	70.81
Sep-03	9.7	35.2	44.8	15.46	56.30	71.76
Dec-03	9.7	35.4	45.1	15.48	56.32	71.80
Mar-04	9.7	36.1	45.8	15.47	57.54	73.01
Jun-04	9.6	36.4	46.0	15.54	59.07	74.62
Sep-04	9.5	37.1	46.7	15.63	60.76	76.40
Dec-04	9.5	37.6	47.1	15.77	62.44	78.21
Mar-05	9.4	38.1	47.6	15.80	63.81	79.61
Jun-05	9.4	39.2	48.6	16.00	66.88	82.88
Sep-05	9.3	39.8	49.0	16.16	69.49	85.66
Dec-05	9.2	38.8	48.0	16.34	69.25	85.59
Mar-06	9.1	39.4	48.5	16.48	71.67	88.14
Jun-06	9.0	40.1	49.1	16.64	73.77	90.42
Sep-06	9.0	40.9	49.9	16.74	76.04	92.78
Dec-06	8.9	41.8	50.7	16.94	79.24	96.19
Mar-07	8.9	41.1	49.9	17.02	78.85	95.87
Jun-07	8.8	42.0	50.8	17.20	82.00	99.20
Sep-07	8.6	39.6	48.2	17.44	79.84	97.27
Dec-07	8.5	38.8	47.3	17.52	80.46	97.98
Mar-08	8.7	35.3	44.0	18.41	74.96	93.37
Jun-08	8.6	34.5	43.1	18.51	74.15	92.66
Sep-08	8.6	33.8	42.4	18.67	73.61	92.28
Dec-08	9.4	33.3	42.7	20.34	72.12	92.46
Mar-09	13.3	34.4	47.7	28.24	73.15	101.39
Jun-09	17.7	35.2	52.9	37.22	74.12	111.34
Sep-09	25.8	35.9	61.7	53.75	74.79	128.54
Dec-09	33.3	35.6	68.8	69.58	74.44	144.03
Mar-10	37.7	35.0	72.7	80.37	74.73	155.11
Jun-10	39.9	34.0	73.9	85.69	73.10	158.79
Sep-10	39.3	34.0	73.2	86.55	74.92	161.47
Dec-10	38.8	34.2	73.0	87.11	76.63	163.75
Mar-11	38.3	34.4	72.7	87.58	78.71	166.29
Jun-11	37.6	33.8	71.4	87.95	79.07	167.02

Source: AsianBondsOnline. http://asianbondsonline.adb.org/hongkong/data/bondmarket.php?code=LCY_in_GDP_Local

2. Size of Foreign Currency Bond Market in Percentage of Gross Domestic Product (Bank for International Settlements)

Table 7.2 Foreign Currency Bonds to Gross Domestic Product Ratio

Date	as % of GDP	FCY Denominated Bonds (in USD billions)	GDP (in USD billions)
Dec-95	11.8	17.1	144.3
Dec-96	11.3	18.0	159.0
Dec-97	12.8	22.6	176.2
Dec-98	13.8	23.0	166.9
Dec-99	17.6	28.7	162.9
Dec-00	16.8	28.5	168.9
Dec-01	18.3	30.4	166.6
Dec-02	23.9	39.1	163.8
Dec-03	27.0	42.9	159.0
Mar-04	27.5	43.8	159.6
Jun-04	27.3	44.4	162.4
Sep-04	28.5	46.7	163.7
Dec-04	28.6	47.5	166.2
Mar-05	29.0	48.6	167.3
Jun-05	28.5	48.6	170.6
Sep-05	30.2	52.8	174.6
Dec-05	27.6	49.2	178.3
Mar-06	27.1	49.3	181.7
Jun-06	26.9	49.5	184.1
Sep-06	26.3	48.8	185.9
Dec-06	25.8	48.9	189.7
Mar-07	25.1	48.2	192.0
Jun-07	25.7	50.2	195.4
Sep-07	24.8	50.0	201.6
Dec-07	23.9	49.6	207.1
Mar-08	23.5	49.9	212.4
Jun-08	23.0	49.5	215.1
Sep-08	22.0	47.9	217.8
Dec-08	22.4	48.6	216.4
Mar-09	21.2	45.1	212.5
Jun-09	22.0	46.4	210.5
Sep-09	22.3	46.4	208.3
Dec-09	22.1	46.3	209.2
Mar-10	23.0	49.0	213.3
Jun-10	23.4	50.3	215.0
Sep-10	25.5	56.2	220.4
Dec-10	28.3	63.4	224.3
Mar-11	28.2	64.6	228.9

Source: AsianBondsOnline. http://asianbondsonline.adb.org/hongkong/data/bondmarket.php?code=FCY_in_GDP

3. Size of Foreign Currency Bond Market (Local Sources)

Table 7.3 Foreign Currency Bonds Outstanding (Local Sources) (USD billion)

Date	Government (in USD Billions)	Banks and Financial Institutions (in USD Billions)	Other Corporates (in USD Billions)	Total FCY (in USD Billions)
Mar-05	1.25	15.88	22.16	39.28
Jun-05	1.25	15.92	22.53	39.7
Sep-05	1.25	16.91	22.46	40.62
Dec-05	1.25	18.35	21.07	40.68
Mar-06	1.25	18.55	21.17	40.98
Jun-06	1.25	17.41	20.94	39.60
Sep-06	1.25	18.15	21.71	41.10
Dec-06	1.25	18.15	22.48	41.88
Mar-07	1.60	19.46	21.04	42.11
Jun-07	1.25	21.49	22.27	45.01
Sep-07	1.60	21.68	20.82	44.09
Dec-07	1.60	21.53	21.42	44.55
Mar-08	1.60	21.98	21.69	45.27
Jun-08	1.60	22.01	22.80	46.41
Sep-08	1.60	22.32	23.75	47.66
Dec-08	1.60	20.86	22.75	45.21
Mar-09	1.60	20.53	21.95	44.08
Jun-09	1.60	20.36	24.69	46.66
Sep-09	1.60	21.86	27.91	51.37
Dec-09	1.60	21.61	32.17	55.38
Mar-10	1.60	24.38	31.07	57.05
Jun-10	1.60	24.33	31.85	57.79
Sep-10	1.60	27.65	34.26	63.51
Dec-10	1.60	30.62	36.40	68.62
Mar-11	1.60	33.88	36.95	72.43
Jun-11	1.60	38.78	41.95	82.33

Source: AsianBondsOnline. http://asianbondsonline.adb.org/hongkong/data/bondmarket.php?code=FCY_Bonds_Outstanding

4. Issuance Volume of Local Currency Bond Market

Table 7.4 Issuance Volume of Local Currency Bond Market (USD billion)

Date	Govt (in USD billions)	Corp (in USD billions)	Total (in USD billions)
Mar-95	12.6703	0	12.6703
Jun-95	14.4325	0	14.4325
Sep-95	15.8629	0	15.8629
Dec-95	15.5009	1.5124	17.0839
Mar-96	18.3050	1.9465	20.2515
Jun-96	15.2637	2.3913	17.7248
Sep-96	16.2871	1.7654	18.0524

continued on next page

Table 7.4 continuation

Date	Govt (in USD billions)	Corp (in USD billions)	Total (in USD billions)
Dec-96	27.7821	3.1144	30.8965
Mar-97	32.9876	1.6560	34.6436
Jun-97	27.5924	3.9699	31.6346
Sep-97	36.2697	3.9738	40.3232
Dec-97	38.1639	3.2726	41.4365
Mar-98	38.0537	2.9023	40.9560
Jun-98	29.1980	4.0261	33.2241
Sep-98	24.6422	3.9653	28.6076
Dec-98	20.8653	2.1267	22.9921
Mar-99	25.6497	4.6189	30.2685
Jun-99	28.1057	3.9664	32.0722
Sep-99	27.4251	6.6683	34.0934
Dec-99	28.4744	4.5266	33.2010
Mar-00	30.3044	7.7536	38.0580
Jun-00	29.0035	5.8991	34.8891
Sep-00	41.4970	6.3053	47.7792
Dec-00	41.0236	3.2554	44.2790
Mar-01	34.3370	4.0535	38.3906
Jun-01	37.1006	6.0602	43.1634
Sep-01	44.1604	5.1172	49.3085
Dec-01	38.5435	4.2307	42.7742
Mar-02	32.6278	6.7201	39.4911
Jun-02	38.6394	7.4807	45.7948
Sep-02	41.1734	4.8840	46.2087
Dec-02	40.5910	4.0351	44.6261
Mar-03	49.3757	5.3874	54.7631
Jun-03	48.1942	6.2419	54.4454
Sep-03	45.5170	4.8994	50.4204
Dec-03	42.0624	5.3501	47.4390
Mar-04	50.3782	5.4807	55.8590
Jun-04	41.2156	5.5493	46.7649
Sep-04	32.3957	5.2526	37.6483
Dec-04	36.6770	5.6479	42.3249
Mar-05	28.8067	6.6220	35.4288
Jun-05	31.7160	7.9984	39.7144
Sep-05	29.5160	5.5990	35.1149
Dec-05	26.9318	3.9976	30.9294
Mar-06	31.5263	8.2323	39.7586
Jun-06	33.8047	7.5592	41.3639
Sep-06	31.1612	7.3003	38.4615
Dec-06	27.7795	6.9697	34.7492
Mar-07	29.7346	7.9372	37.6718
Jun-07	30.1378	9.5277	39.6654
Sep-07	23.6669	4.1971	27.8640

continued on next page

Table 7.4 continuation

Date	Govt (in USD billions)	Corp (in USD billions)	Total (in USD billions)
Dec-07	35.4474	6.6836	42.1310
Mar-08	41.3260	2.7419	44.0678
Jun-08	40.7425	7.0390	47.7815
Sep-08	20.4425	4.8980	25.3404
Dec-08	45.8886	3.1263	49.0150
Mar-09	78.6807	6.7589	85.4396
Jun-09	148.278	7.4591	155.7371
Sep-09	162.7954	6.1607	168.956
Dec-09	217.7029	4.6951	222.3980
Mar-10	340.7332	6.1066	346.8398
Jun-10	168.8285	4.8981	173.7266
Sep-10	237.6786	5.7404	243.4190
Dec-10	163.690	6.3186	170.0086
Mar-11	336.7342	6.7028	343.4370
Jun-11	78.2567	7.8744	86.1311

Source: AsianBondsOnline. http://asianbondsonline.adb.org/hongkong/data/bondmarket.php?code=Issuance_Volume_LCY

5. Domestic Financing Profile

Table 7.5 Domestic Financing Profile

Date	Domestic Credit (% of Total)	Bonds (% of Total)	Equity (% of Total)	Domestic Credit (in USD billions)	Bonds (in USD billions)	Equity (in USD billions)	Total (in USD billions)
Dec-00	25.15	6.62	68.23	229.76	60.50	623.40	913.66
Dec-01	28.83	7.91	63.25	230.69	63.30	506.07	800.06
Dec-02	30.53	8.90	60.57	233.41	68.08	463.05	764.54
Dec-03	22.80	7.05	70.15	232.32	71.80	714.60	1018.71
Dec-04	20.6	6.61	72.79	243.77	78.21	861.46	1183.44
Dec-05	18.24	6.14	75.62	254.52	85.59	1055	1395.11
Dec-06	12.35	4.65	83.00	255.13	96.18	1714.95	2066.27
Mar-07	12.84	4.57	82.60	269.49	95.87	1734.12	2099.48
Jun-07	11.59	4.12	84.29	278.73	99.20	2028	2405.93
Sep-07	9.44	3.29	87.27	279.36	97.28	2581.50	2958.14
Dec-07	8.62	3.25	88.13	259.68	97.98	2654.42	3012.07
Mar-08	10.70	3.67	85.63	272.06	93.37	2176.89	2542.32
Jun-08	12.06	3.72	84.22	300.19	92.66	2096.44	2489.30
Sep-08	14.96	4.60	80.45	300.16	92.28	1614.59	2007.03
Dec-08	15.94	5.47	78.59	269.54	92.46	1328.77	1690.77
Mar-09	15.60	6.08	78.33	260.22	101.39	1306.75	1668.36
Jun-09	13.47	4.97	81.56	301.39	111.34	1825.47	2238.20
Sep-09	12.88	5.12	82.00	323.44	128.54	2059.30	2511.27
Dec-09	12.54	5.14	82.32	351.05	144.02	2305.14	2800.21
Mar-10	13.17	5.43	81.40	376.18	155.10	2325.35	2856.63
Jun-10	15.02	5.72	79.26	416.78	158.79	2199.90	2775.47

continued on next page

Table 7.5 continuation

Date	Domestic Credit (% of Total)	Bonds (% of Total)	Equity (% of Total)	Domestic Credit (in USD billions)	Bonds (in USD billions)	Equity (in USD billions)	Total (in USD billions)
Sep-10	14.23	5.13	80.64	447.54	161.47	2535.96	3144.97
Dec-10	13.43	4.93	81.64	445.94	163.74	2711.32	3320.99
Mar-11	13.95	4.91	81.15	472.82	166.29	2750.88	3389.99

Source: AsianBondsOnline, http://asianbondsonline.adb.org/hongkong/data/bondmarket.php?code=Domestic_Financing_profile

6. Trading Volume

Table 7.6 Trading Volume (\$ billion)

Year	Govt Bonds (in USD billions)	Corp Bonds (in USD billions)	Total (in USD billions)
Sep-95	109.45	-	-
Dec-95	120.48	-	-
Mar-96	167.86	-	-
Jun-96	145.88	-	-
Sep-96	96.41	-	-
Dec-96	121.47	-	-
Mar-97	196.87	-	-
Jun-97	179.02	-	-
Sep-97	93.57	-	-
Dec-97	67.51	-	-
Mar-98	74.36	-	-
Jun-98	87.91	-	-
Sep-98	66.96	-	-
Dec-98	65.94	-	-
Mar-99	93.05	-	-
Jun-99	105.35	-	-
Sep-99	130.71	-	-
Dec-99	194.15	-	-
Mar-00	189.44	-	-
Jun-00	192.72	-	-
Sep-00	193.82	-	-
Dec-00	192.86	-	-
Mar-01	173.56	-	-
Jun-01	167.59	-	-
Sep-01	159.15	-	-
Dec-01	184.89	-	-
Mar-02	179.89	-	-
Jun-02	183.14	-	-
Sep-02	188.88	-	-
Dec-02	169.96	2.88	172.84
Mar-03	224.62	2.66	227.28
Jun-03	192.16	3.26	195.42
Sep-03	136.21	2.39	138.6
Dec-03	120.30	3.22	123.52

continued on next page

Table 7.6 continuation

Year	Govt Bonds (in USD billions)	Corp Bonds (in USD billions)	Total (in USD billions)
Mar-04	116.14	2.59	118.73
Jun-04	141.41	3.79	145.2
Sep-04	147.68	3.24	150.92
Dec-04	135.77	3.47	139.24
Mar-05	200.19	3.53	203.72
Jun-05	195.94	2.97	198.91
Sep-05	209.09	4.08	213.17
Dec-05	250.71	2.29	253.00
Mar-06	262.08	3.26	265.34
Jun-06	321.65	2.76	324.41
Sep-06	298.60	3.51	302.11
Dec-06	271.27	2.69	273.96
Mar-07	282.51	2.88	285.39
Jun-07	398.32	5.27	403.59
Sep-07	491.19	2.31	493.5
Dec-07	386.38	3.47	389.85
Mar-08	416.28	2.85	419.13
Jun-08	405.37	3.61	408.98
Sep-08	366.69	3.03	369.72
Dec-08	425.66	1.82	427.48
Mar-09	691.93	2.05	693.98
Jun-09	1026.60	3.86	1030.46
Sep-09	1438.50	4.15	1442.65
Dec-09	2368.91	2.51	2371.42
Mar-10	2411.42	3.64	2415.06
Jun-10	2329.05	3.80	2332.85
Sep-10	2994.86	3.80	2998.66
Dec-10	4304.30	4.44	4308.74
Mar-11	6351.33	4.01	6355.34

Source: AsianBondsOnline. http://asianbondsonline.adb.org/hongkong/data/bondmarket.php?code=Trading_Volume

VIII. Presence of an Islamic Finance (Islamic bond [*Sukuk*]) Market

A. Regulatory Framework for Islamic Finance

In reference to the relevant laws relating to tax issues as stated in VIII.D, the regulatory and legal framework for Islamic finance largely follows those applicable to conventional debt instruments.

B. Types of Available Instruments, Segments, and Tenure

Though the market infrastructure, regulatory and legal framework are in place, the market remains inactive for the time being, probably due to the tax issues stated in VIII.D.

C. Basic Market Infrastructure for Islamic Finance

Enhancements have been made to the US dollar and euro real-time gross settlement systems, as well as the CMU in Hong Kong, China to facilitate the process for participating members to identify transactions related to Islamic finance and to segregate Islamic-related funds from others.

D. Tax-Related Issues

The key tax issue relating to Islamic bond is that the arrangement operates in the form of equity finance but is in substance similar to debt finance. In Hong Kong, tax law treats debt and equity differently. For instance, interest income and interest expenses arising from a debt finance arrangement may be taxable and deductible subject to certain conditions. In contrast, dividend income and distribution arising from an equity finance arrangement are generally not taxable or deductible.

As a result of a heavier tax burden, issuing and/or investing in Islamic bonds may be less favorable than issuing and/or investing in conventional debt instruments.

The Government is studying how to take forward amendments to the relevant laws to facilitate development of a local Islamic bond market, by levelling the playing field for Islamic bonds vis-à-vis their conventional counterparts as far as tax arrangements are concerned.

IX. History of Debt Market Development

A. Overview

The debt market in Hong Kong, China began in the late 1970s with the first debt instrument issued by a private entity. There was virtually no debt issued by the Government or related bodies during this period due to a cumulative fiscal surplus. The activities of the debt market thus remained limited.

With a view to facilitate the development of the local debt market, the Hong Kong Monetary Authority (HKMA) rolled out the Exchange Fund Bills and Notes Programme in 1990. The amounts of issuance and outstanding debt instruments have shown rapid growth since then.

B. The Development of Hong Kong Debt Markets³⁷

Over the past 10 years, the Hong Kong, China government has contributed significantly to the growth of capital markets by introducing a number of measures designed to further develop an efficient infrastructure for the Hong Kong dollar bond market. These measures include the establishment in 1990 of the Central Moneymarkets Unit (CMU), which provides an efficient settlement, central clearing and custodian system for Hong Kong-dollar debt securities, and the introduction of the Exchange Fund Bills and Notes Programme to create a benchmark yield curve extending to 10 years.

1. Central Moneymarkets Unit

The CMU was set up primarily to provide computerized clearing and settlement facilities for Exchange Fund Bills and Notes. In December 1993, the HKMA extended the service to other Hong Kong-dollar debt securities. Since December 1994, the CMU has been linked to international clearing systems such as Euroclear and Clearstream. This has helped to promote Hong Kong-dollar debt securities to overseas issuers and investors who can make use of these links to participate in the Hong Kong-dollar debt market. In December 1996, an interface between the CMU and the real-time

³⁷ Li, Tony. n.d. *Market Overview: Hong Kong Capital Markets Association*. http://www.hkma.org/about_us/market_overview.html

gross settlement (RTGS) interbank payment system was established. This enables the CMU system to provide its members with real-time and end-of-day delivery-versus-payment (DVP) services. Other market infrastructure enhancements by the CMU include launching a Securities Lending Programme for private sector securities in December 1997. The aim of this program was to enhance the liquidity of private-sector debt securities by providing a mechanism to make securities held by long-term investors available for short-term use by more active market participants.

The HKMA launched the Exchange Fund Bills Programme in March 1990. Exchange Fund Bills and Notes are Hong Kong-dollar debt securities issued by the HKMA. The Exchange Fund Bills and Notes constitute direct, unsecured, unconditional and general obligations of the government of Hong Kong, China for the account of the Exchange Fund.

The Exchange Fund Bills and Notes Programme ensures the supply of high quality Hong Kong-dollar debt paper that can be employed as trading, investment and hedging instruments. Banks that maintain Hong Kong-dollar clearing accounts with the HKMA can use their holdings of Exchange Fund paper to borrow Hong Kong dollars overnight from the discount window. Under the program, bills that have tenors of less than 1 year are regularly auctioned by way of public tender. To facilitate the management of liquidity by banks participating in the RTGS, three tap issues of 28-day Exchange Fund Bills have been issued since November 1996. As banks in Hong Kong have become more proficient in managing their intraday liquidity, demand for tap issues has fallen. Consequently, the HKMA has gradually reduced the size of each of the tap issues of 28-day Exchange Fund Bills and replaced them with a range of longer term Exchange Fund Notes.

Two-year and 3-year Exchange Fund Notes were introduced in May 1993 and October 1993, respectively. This was followed by the inaugural issue of 5-year Exchange Fund Notes in September 1994, 7-year Exchange Fund Notes in November 1995, and 10-year Exchange Fund Notes in October 1996.

As of the end of 2010, the value of outstanding Exchange Fund Bills and Notes totalled HKD653 billion.

2. Corporate Bond Market

The private sector bond market is currently just over twice the size of the Exchange Fund Bills and Notes market. As of 30 September 2002, the total value of outstanding private sector bonds was HKD408 billion. The largest issuer category was local banks and corporations, followed by international banks and then supranational bodies.

3. Market History

According to available records, the first debt market issue in Hong Kong, China was a certificate of deposit issue launched in September 1977 by Chase Manhattan Bank. The issue size was HKD100 million—a large issue at the time. It was a 5-year issue with a coupon rate of prime but subject to an interest rate floor of 5.25%.

The first fixed-rate issue was launched in July 1980. It was an 18-month issue and carried a coupon of 10%. The issuer was Banque Paribas and issue size was HKD70 million. The interbank money market was still rather undeveloped at that

time and certificate of deposit issuance was the only way for international banks to raise Hong Kong-dollar funds.

The first swap-driven issue occurred in 1984 when interest-rate swaps were introduced into the Hong Kong-dollar market. The coupon of the issue was 11.625% and the swap counterparty was a major property company in Hong Kong.

Supranational issuers have also played an important role in the development of the Hong Kong-dollar bond market. The first supranational issue was launched in 1989 by the World Bank, which was the first supranational issuer to tap the Hong Kong-dollar market after the Hong Kong government granted tax exemption on interest and capital gains on holding supranational paper. The availability of this type of high-quality paper helped attract investor attention and enlarge the investor base for Hong Kong-dollar bonds.

The Hong Kong dollar bond market has developed rapidly in the last several years. New issue volume was below HKD100 billion in 1997 but has grown to a level of between HKD150 billion and HKD180 billion per year in the last 2 years. While the floating-rate market has remained fairly stable, there has been substantial growth in the fixed-rate market. This was the result of a more conservative investment attitude after the Asian financial crisis and a deflationary environment that gave Hong Kong-dollar bond investors an attractive real rate of return.

Excluding the yen bond market, the Hong Kong-dollar market is the second largest Asian currency bond market, ranking just after the Korean won market. It is the most open market among the Asian currency bond markets although in terms of diversity of issuers, the Korean won and the Singapore dollar markets seem to show a greater range.

At a global level, the Hong Kong dollar is an important medium-term note (MTN) issuance currency. In 2001, the volume of MTNs denominated in Hong Kong dollars ranked just after the US dollar, euro, yen and British pound as the fifth most popular issuance currency. However, the average size of Hong Kong dollar issues is small relative to these other four currencies.

In terms of issuer type, international banks have replaced supranational entities as the most active issuers. Supranational issuers normally have more aggressive issuing targets than international banks. With investor interest increasingly concentrated in the short end of the credit curve, issuance by international banks has more than doubled in the last 2 years.

The Hong Kong-dollar market is primarily a private placement market. Issue size typically is around HKD100 million to HKD200 million. Usually, there is only one arranger taking down the issue from an issuance program and selling the paper to a small number of investors. The private placement nature of the market means the secondary market has not been very active because:

- (i) a small issue size means there are a small number of investors involved which generally leads to lower liquidity; and
- (ii) in a private placement, banks other than the lead managers will not feel obligated to make a market in an issue in which they have no involvement.

In terms of tenor, the market is dominated by three- to five-year issues, which represent about 65% of total issuance. Tenor longer than 7 years only represents 3% of the market. This explains why many Hong Kong issuers have to issue in the US dollar market if they want to obtain long tenor, although almost all of them will enter into a Hong Kong Interbank Offered Rate/London Interbank Offered Rate (HIBOR/LIBOR) basis swap to hedge US-dollar proceeds back to Hong Kong dollars.

Although many investors are prepared to go down the credit curve, the Hong Kong-dollar market is still a high investment-grade market with single A or better rated issues accounting for 80% of total issuance. It is expected that the Hong Kong-dollar market will remain a high-grade market for the foreseeable future.

4. Institutional Investors

Investors in Hong Kong, China can broadly be divided into three major categories: the retirement funds, which are commonly referred to in Hong Kong, China as Mandatory Provident Fund (MPF); the Hong Kong banking institutions; and Hong Kong government-related institutions.

The MPF scheme was introduced in December 2000 and covers over 90% of the Hong Kong work force. Under the MPF scheme, both employer and employee are obligated to contribute amounts equivalent to 5% of the employee's monthly income (mandatory payments are only due on the first HKD20,000 of monthly salaries, i.e., the maximum mandatory payment for employer and employee is HKD1,000 each per month) to the MPF. The size of the retirement fund market in Hong Kong, China in mid-2002 was more than HKD200 billion. It is expected that when the scheme is fully mature, the total size of this market will grow by HKD36 billion per year.

Banking institutions are the largest investor category in Hong Kong, China. The total amount of Hong Kong dollar deposits in the banking system is currently about HKD1.8 trillion. As of October 2001, banking institutions in Hong Kong were holding Hong Kong dollar non-government bonds worth about HKD230 billion in their portfolios. Under the banking regulations in Hong Kong, banks have to keep 25% of the deposits they accept in liquid assets. Among other things, debt securities are regarded as liquid assets.

Government-related institutional investors include the Housing Authority, the School Fund, and the Hospital Authority. Although not strictly a government-related institution, the Hong Kong Jockey Club is also an important Hong Kong dollar investor. The investment subsidiaries of a number of central banks in the region are also significant buyers of high-grade Hong Kong dollar bonds.

5. Retail Investors

Unlike the case in other markets, there is currently no overlap between the institutional and the retail markets in Hong Kong, China. Institutional investors do

not participate in the retail market due to its tight pricing. Retail investors cannot buy institution-targeted issues due to the large denomination. This contrasts with other public markets where both institutional and retail investors get the same price. In the equity initial public offering (IPO) market in Hong Kong, China retail investors usually get a better deal than institutional buyers.

The Hong Kong Mortgage Corporation continues to be a pioneer in the development of the retail bond market. The corporation has tried a variety of ways to access the retail market, some of which have been more successful than others. One of the first strategies was to use stockbrokers to distribute using the equity IPO mechanism. However, this proved to be a costly and ineffective distribution channel. A small group of banks with retail branch networks were then signed up to distribute bonds over the counter. This method proved to be more effective as bonds are good substitutes for bank deposits. The number of banks involved in recent retail targeted issues has expanded to more than 10 and the number of branches involved increased to nearly 500. The introduction of underwriting banks has helped issuers shift a significant amount of market risk to the underwriters.

There are a number of factors contributing to the quick development of the retail market. The current low interest rate environment and a conservative investment attitude are two key influences. Public awareness and educational campaigns undertaken by the Hong Kong Capital Markets Association is another key element. The increasing awareness of wealth management by banks and their customers and the introduction of investment accounts are helping to make bond purchases over the counter as convenient as buying stocks through brokers. With the removal of the interest rate cartel, banks must now increasingly compete more on non-deposit products and are therefore more eager to help selling bonds. In the past, banks were reluctant to sell bonds as they were regarded as directly competing with deposits.

The Securities and Futures Commission has recently adopted a more “issuer friendly” attitude towards new bond issues. This has made the issuing process smoother and issuers are now less exposed to market risks. Under the leadership of the Financial Service Bureau, outdated laws governing the issuance of bonds as established in the *Companies Ordinance* and the *Protection of Investors Ordinance* are being reviewed.

Industry professionals have welcomed these changes and hope to see additional steps taken by regulatory authorities to further improve the environment for new bond issues. In particular, industry participants look forward to seeing the prospectus requirements for bond issuance to be made less onerous than those for equity requirements as these two instruments entail very different risks.

X. Next Step ⇔ Future Direction

A. Offshore Renminbi Bond Market (Dim-Sum Bond)

Chinese offshore renminbi (RMB) denominated debt securities, commonly known as *Dim-Sum Bonds*, represent an opportunity to invest in Chinese debt securities for those investors who may not qualify for, or may choose not to avail themselves of, the Qualified Foreign Institutional Investor (QFII) scheme or similar investment avenues into China.

Due to Hong Kong's position as an official RMB offshore center, the Hong Kong market features:

- (i) An abundant supply of RMB liquidity in the offshore market;
- (ii) No restrictions on the usage of RMB in the offshore market; and
- (iii) A well-developed RMB-related financial infrastructure in Hong Kong, China.

Leveraging these competitive advantages, the HKMA will continue its efforts to promote and develop the RMB bond market in Hong Kong, China.

- (iv) Sales of *Dim-Sum Bonds* increased to RMB144.1 billion in 2011, four times the RMB 35.7 billion of issuance for all of 2010, according to data compiled by Bloomberg.³⁸ One of the most significant recent *Dim-Sum Bonds* placements was the Baosteel Group November-2011 issue of RMB3.6 billion, across two-, three- and five-year tenures.

B. Enhancements to Post-Trade Processing in Asian Bond Markets

The HKMA will continue to collaborate with central banks and central securities depositories in the region to improve the post-trade environment in Asia, taking into account the specific needs for Asia in terms of cross-border access, stimulation of

³⁸ Bloomberg News, Nov 28, 2011

local issuance, automation of the post-trade process, the possibility of cross-border collateralization, and the reduction in post-trade costs.

C. Group of Thirty Compliance

The so-called G-30 Recommendations were originally conceived as the Group of Thirty's Standards on Securities Settlement Systems in 1989, detailing in a first-of-its-kind report nine recommendations for efficient and effective securities markets and covering legal, structural and settlement process areas. The recommendations were subsequently reviewed and updated in 2001, under leadership of the Bank for International Settlements (BIS), and through the efforts of a Joint Task Force of the Committee On Payment and Settlement Systems (CPSS) and the Technical Committee of the International Organisation of Securities Commissions (IOSCO). Compliance with the G30 Recommendations in individual markets is often an integral part in securities industry participants' and intermediaries' due diligence process.

Table 10.1 Group of Thirty Compliance Recommendations

Recommendation		Implemented
1	Eliminate paper and automate communication, data capture, and enrichment.	No (Paper securities certificates still exist while most of the shares and bonds are safekept in central depository and can be transfer via book keeping records)
2	Harmonize messaging standards and communication protocols.	Yes
3	Develop and implement reference data standards.	Yes (Common data standard such as ISIN and SWIFT BICs are used in local markets)
4	Synchronize timing between different clearing and settlement systems and associated payment and foreign exchange systems.	No (Real Time Gross Settlement Mode is optional and good payment for normal securities settlement will only be confirmed at next day morning)
5	Automate and standardize institutional trade matching.	Yes
6	Expand the use of central counterparties.	Yes (only for settlement for on exchange trades)
7	Permit securities lending and borrowing to expedite settlement.	Yes
8	Automate and standardize asset servicing processes, including corporate actions, tax relief arrangements, and restrictions on foreign ownership.	Corporate actions: No Taxation: Not applicable in Hong Kong. Foreign ownership restrictions: Yes.
9	Ensure the financial integrity of providers of clearing and settlement services.	Yes
10	Reinforce the risk management practices of users of clearing and settlement service providers.	Yes
11	Ensure final, simultaneous transfer and availability of assets.	Yes
12	Ensure effective business continuity and disaster recovery planning.	Yes
13	Address the possibility of failure of a systematically important institution.	Yes
14	Strengthen assessment of the enforceability of contracts.	Yes
15	Advance legal certainty over rights to securities, cash, or collateral.	Yes
16	Recognize and support improved valuation methodologies and closeout netting arrangements.	Yes
17	Ensure appointment of appropriately experienced and senior board members (of the boards of securities clearing and settlement infrastructure providers).	Yes
18	Promote fair access to securities clearing and settlement networks.	Yes
19	Ensure equitable and effective attention to stakeholder interests.	Yes

continued on next page

Table 10.1 continuation

Recommendation		Implemented
20	Encourage consistent regulation and oversight of securities clearing and settlement service providers.	Yes
Source: Group of 30 (G30), 2003. Global Clearing and Settlement—A Plan of Action. http://www.partad.ru/world/world/g30app1.pdf		

D. Group of Experts Barrier Report Market Assessment - Hong Kong (April/2010)

The GoE Report refers to the published results in 2010 of the Group of Experts (GoE) formed under Task Force 4 of the Asian Bond Market Initiative (ABMI). In the report, published under the leadership of the Asian Development Bank (ADB), a group of securities market experts from the private and public sector in ASEAN+3, as well as International Experts, assessed the ASEAN+3 securities markets on potential market barriers, the costs for cross-border bond transactions, and the feasibility for the establishment of a Regional Settlement Intermediary (RSI). The findings in the GoE Report lead to the creation of ABMF.

Table 10.2 Group of Experts Barrier Report Market Assessment on Hong Kong, China

Potential barrier area	Current situation	Market Assessment Questionnaire scores	Overall barrier assessment
Quotas	There are no quotas on foreign involvement in the local market.	OK	OK
Investor registration	There are no foreign investor registration requirements.	OK	OK
FX controls - conversion	There are no exchange control restrictions on residents or non-residents. HKD is freely convertible.	OK	OK
FX controls - repatriation of funds	There is no restriction on the repatriation of funds.	OK	OK
Cash controls - credit balances	Non-residents may open accounts in HKD or in foreign currency. Credit balances are allowed.	OK	OK
Cash controls - overdrafts	Overdrafts are allowed.	OK	OK
Taxes	There is no withholding tax on any financial instrument. There is no capital gains tax in Hong Kong.	OK	OK
Omnibus accounts	Omnibus accounts are allowed.	OK	OK
Settlement cycle	The settlement cycle is T+2 for listed debt securities.	OK	OK
Message formats	CMU uses SWIFT for settlement messages, and plans to introduce SWIFT for corporate events messages from November 2009. Most local market participants use SWIFT format.	OK	OK
Securities numbering	ISIN are available for most local bond issues. ISIN are allocated at the time of issue or auction. CMU and local market participants use ISIN, but the local numbering (CMU Issue Number) is also commonly used.	OK	OK
Matching	There is no trade matching system for the local bond market. CMU pre-matches forward dated settlement instructions.	LOW	LOW
Dematerialisation	All fixed income instruments are either dematerialised or immobilised at the CSD.	LOW	LOW
Regulatory framework	The regulatory regime is regarded as stable and consistent and no adverse comments were received in this area.	-	OK

Source: Asian Development Bank. 2010. *Asian Bond Markets Initiative Group of Experts Final Report: Barriers to Cross-Border Investment and Settlement in the ASEAN+3 Bond Markets*. https://wpqr1.adb.org/LotusQuickr/asean3goe/Main.nsf/h_58E34A1388F9070B48257729000C0A4E/90F408746

Appendixes

Appendix 1.

Central Moneymarkets Unit Tariff (CMU Instruments) Effective Date: 12 July 2010

Table A1.1 Central Moneymarkets Unit Tariff (CMU Instruments)

Membership Fee	Fee Amount
Custodian Fee (Borne by holders)*	Sliding scale: (HKD millions) Rate (b.p.) <15,000 0.32 15,000-20,000 0.30 >20,000 0.25
Fees relating to New Issues (to be borne by issuer/lodging agent)	
Administration Fee	\$1,500
CMU BID – Tender for CMU Instrument	\$1,500
Transaction Fee	
DvP or FoP (by SWIFT/CMT)	\$20
DvP or FoP (by fax)	\$150
In house transfer (by SWIFT/CMT)	\$10
In house transfer (by fax)	\$150
Income Distribution Service (to be borne by the paying agent)	\$1,000 (per income event per issue)
HKD Repo Transaction Fee	
Intraday Repo	No Charge
Discount Window Repo	No Charge
Bank Repo (by CMT)	\$20
Bank Repo (by fax)	\$150

continued on next page

Table A1.1 continuation

Membership Fee	Fee Amount	
Foreign Currency Repo Transaction Fee		
Automatic Intraday Repo (USD, EUR)		\$15
Automatic Overnight Repo (USD, EUR)		\$15
Intraday/Overnight Repo (by fax)		\$150
Bank Repo (CNY) by CMT		\$20
Bank Repo (CNY) by fax		\$150
Securities Lending Program	Lender	1.00%
	Borrower	1.20%
Reporting Fee (SWIFT/CMT)		\$0.5 per kilobyte
Enquiry Fee (SWIFT/CMT)		\$0.5 per screen page
All fees are in Hong Kong dollar		
* Remark: Custodian fees will be waived if CMU member certify that the beneficial owners are individuals.		
Source: Hong Kong Monetary Authority.		

Supplementary Notes

1. The fee schedule may be modified by CMU from time to time, however, CMU undertakes to advise our members in advance of such changes.
2. Custodian fee on account holders will be waived if CMU members can certify that the beneficial owners are individuals. Please refer to Appendix A.12a of the Central Moneymarkets Unit Service Reference Manual - "Guideline for Exemption of Custodian Fee for Retail Investors" for details of the exemption.
3. Custodian fee on account holders will only apply for those CMU Instruments lodged with CMU after 1 January 2005. Those lodged before 1 January 2005 have already been paid by lodging agent and will not be subject to any additional custodian fee.
4. CMU Tariff, as effective from 1 January 2005, will also apply to transactions and holdings relating to CMU's linkages with Austraclear in Australia and in New Zealand, and Korean Securities Depository in Korea.
5. Calculation of custodian fee
 - a) Custodian fees are calculated based on monthly average nominal value of securities held in the CMU account. These average amounts are converted into Hong Kong dollar at the exchange rate prevailing at the end of the month and aggregated to obtain the monthly average value.
 - b) The custodian fee will be invoiced in Hong Kong dollar.
 - c) Custodian fees are calculated on an actual/365 day basis and expressed in basis points per annum. (1bp=0.01%)
 - d) An example of custodian fees calculation of a member with an average monthly holding of CMU Instruments of HKD23,000 mn is shown below.

Holdings (HKD millions)	Fee Rate (b.p.)	Holdings by Member (HKD millions)	Custodian Fee for the Month (HKD)
<15,000	0.32	The first 15,000	40,767.12
15,000–20,000	0.30	The next 5,000	12,739.72
>20,000	0.25	The next 3,000	6,369.86
	Total	23,000	59,876.70

6. All fees are invoiced in Hong Kong dollar and billed monthly to CMU members. The total amount of fees payable will be advised to the members on the 20th day of the following month or the next business day if the 20th is not a business day. The total fees will be automatically debited from the members' clearing account with the HKMA (for direct clearing members) or the clearing account of their correspondent banks (for non-direct clearing members) on the 25th or the following business day if 25th is not a business day.
7. Report fees are charged based on usage by the participant irrespective of the types of securities involved and channels (FTS, CMT or SWIFT) received, i.e., a report involving Exchange Fund Paper, Government Bonds and CMU Instruments will be subject to the same report tariff rate. The report fee is applicable even if the report contains no item, but only the header and footer information.
8. Enquiry fees are charged based on the number of screen pages returned to the participant for an enquiry initiated at CMT irrespective of the types of securities involved, i.e., an enquiry involving Exchange Fund Paper, Government Bonds and CMU Instruments will be subject to the same enquiry tariff rate. The number of retrieved and displayed items per screen page returned is set by the participant.

Appendix 2.

Listing Fees for Debt Securities

In a new release on 8 March 2002, Hong Kong Exchanges and Clearing Limited (“HKEx”) proposed to reduce the fees and charges of its wholly owned subsidiaries, The Stock Exchange of Hong Kong Limited (“SEHK”) and Hong Kong Futures Exchange Limited (“HKFE”), in respect of certain securities, derivative products and the provision of market data with the view to enhance its competitiveness and to increase the attractiveness of Hong Kong to both local and international issuers and investors.

The current listing fees for debt securities are contained in Appendix 8 to the HKEx rules and regulations, Section 1A and have been provided below for easy reference:

Box A2.1. Appendix 8 Listing Fees, Transaction Levies and Trading Fees on New Issues and Brokerage

Appendix 8 Listing Fees, Transaction Levies and Trading Fees on New Issues and Brokerage

1. Initial Listing Fee

- (1) In the case of an issue of equity securities by a new applicant, other than units in a unit trust, redeemable shares in a mutual fund, or an issue of securities by an openended investment company or other collective investment scheme, an initial listing fee shall be payable on the application for listing as follows:—

	Monetary value of the equity securities to be listed HK\$M	Initial listing fee HK\$
Not exceeding	100	150,000
	200	175,000
	300	200,000
	400	225,000
	500	250,000
	750	300,000
	1,000	350,000
	1,500	400,000
	2,000	450,000
	2,500	500,000
	3,000	550,000
	4,000	600,000
	5,000	600,000
Over	5,000	650,000

Note: An “open-ended investment company” is an investment company which is or holds itself out as being engaged primarily, or proposes to engage primarily, in the business of investing, reinvesting or trading in securities or collective investment schemes and which is offering for sale or has outstanding any redeemable shares or their functional equivalent of which it is the issuer.

- (2) A new applicant shall pay the initial listing fee, in advance, at the same time as it submits its listing application form, in accordance with rules 9.03 and 20.08, as appropriate.
- (3) In a transfer of listing from GEM to the Main Board, the new applicant shall pay the initial listing fee at 50% discount to the scaled fees set out in 1(1), in accordance with the provisions of Chapter 9A.

1A. Debt Securities and Structured Products

continued on next page

Box A.2.1 continuation

- (1) In the case of a new listing of debt securities on or after 1st July, 2002 whether by a new applicant or otherwise, where the term of such debt securities until maturity is:—
- (a) less than 2 years the listing fee payable in one lump sum upon the application of the listing of such debt securities shall be:
 - (1) HK\$10,000 for up to HK\$100 million of debt securities issued;
 - (2) HK\$12,500 for more than HK\$100 million but equal to or less than HK\$500 million of debt securities issued;
 - (3) HK\$24,000 for more than HK\$500 million of debt securities issued;
 - (b) more than or equal to 2 years but less than or equal to 5 years, the listing fee payable in one single lump sum upon the application of the listing of such debt securities shall be:
 - (1) HK\$20,000 for up to HK\$100 million of debt securities issued;
 - (2) HK\$25,000 for more than HK\$100 million but equal to or less than HK\$500 million of debt securities issued;
 - (3) HK\$39,000 for more than HK\$500 million of debt securities issued;
 - (c) more than 5 years but equal to or less than 10 years, the listing fee payable in one single lump sum upon the application of the listing of such debt securities shall be:
 - (1) HK\$25,000 for up to HK\$100 million of debt securities issued;
 - (2) HK\$30,000 for more than HK\$100 million but equal to or less than HK\$500 million of debt securities issued;
 - (3) HK\$55,000 for more than HK\$500 million of debt securities issued;
 - (d) more than 10 years, the listing fee payable in one single lump sum upon the application of the listing of such securities shall be:
 - (1) HK\$25,000 plus an additional HK\$5,000 per each year or part year that the term of the debt securities exceeds ten years for up to HK\$100 million of debt securities issued, provided that the listing fee shall not exceed HK\$60,000;
 - (2) HK\$30,000 plus an additional HK\$5,000 per each year or part year that the term of the debt securities exceeds ten years for more than HK\$100 million but equal to or less than HK\$500 million of debt securities issued, provided that the listing fee shall not exceed HK\$70,000;
 - (3) HK\$55,000 plus an additional HK\$5,000 per each year or part year that the term of the debt securities exceeds ten years for more than HK\$500 million of debt securities issued, provided that the listing fee shall not exceed HK\$90,000;
- Provided that for securities listed before 1st July, 2002 which had a term to maturity at the time of listing of more than ten years, a listing fee of HK\$6,000 shall be payable annually from the expiry of the first ten years of the listing.
- (2) (a) In the case of an application in respect of a new listing, a continuance or an increase in size of a debt issuance programme, the listing fee payable upon the application of such listing, continuance or increase in size of such debt issuance programme shall be HK\$15,000.
 - (b) In the case of a listing of new issue of debt securities to be issued under a debt issuance programme pursuant to 1A(2)(a) above, the listing fees payable in one single lump sum upon the application of the listing of such debt securities (issued under a debt issuance programme) shall be 70% of the listing fees payable under 1A(1)(a), 1A(1)(b), 1A(1)(c), or 1A(1)(d) as the case may be, rounded upwards to the nearest HK\$1,000.
- (3) In the case of all those debt securities which were listed before 1st January 1997, whether by a new applicant or otherwise, the annual listing fees payable for the same shall continue to be payable in accordance with 2(1)(b) and/or 2(1)(e) (as the case may be).
- (4) (a) The listing fee for an issue of structured products is normally payable in one single lump sum upon the application of the listing of such structured product. The Exchange and/or HKEC may operate discount or rebate schemes for fees in respect of structured products or types of structured product. In such cases the Exchange may permit the fee to be paid net of such discounts or rebate.
 - (b) In the case of an issue of structured products, except equity linked instruments and callable bull/bear contracts, the listing fees payable in one single lump sum upon the application of the listing of such structured product shall be HK\$60,000 (the "Basic Fee") for the first issue launched in any calendar year by an issuer over a particular security, index, currency or other asset and HK\$40,000 (the "Reduced Fee") for any subsequent issues launched in that same calendar year by that issuer over the same underlying security, index, currency or other asset. The fee for baskets shall be HK\$60,000 for each issue and each subsequent issue.
 - (c) In the case of an issue of equity linked instruments the listing fee, payable in one lump sum upon the application of the listing of such equity linked instrument, shall be:
 - (i) HK\$5,000 if the market capitalisation is equal to HK\$10 million;
 - (ii) HK\$10,000 if the market capitalisation is greater than HK\$10 million and up to or equal to HK\$50 million; and
 - (iii) HK\$15,000 if the market capitalisation is greater than HK\$50 million for the first issue launched in any calendar year by an issuer over a particular security, index, currency or other asset. For any subsequent issues launched in that same calendar year by that issuer over the

continued on next page

Box A.2.1 continuation

same underlying security, index, currency or other asset, the listing fee, payable in one lump sum upon the application of the of the listing of such equity linked instrument, shall be:

- (1) HK\$3,000 if the market capitalisation is equal to HK\$10 million;
- (2) HK\$6,000 if the market capitalisation is greater than HK\$10 million and up to or equal to HK\$50 million; and
- (3) HK\$9,000 if the market capitalisation is greater than HK\$50 million.

The fee for basket equity linked instruments, payable in one lump sum upon the application of the listing of such equity linked instrument, shall be:

- (I) HK\$5,000 if the market capitalisation is equal to HK\$10 million;
 - (II) HK\$10,000 if the market capitalisation is greater than HK\$10 million and up to or equal to HK\$50 million; and
 - (III) HK\$15,000 if the market capitalisation is greater than HK\$50 million.
- (d) In the case of an issue of callable bull/bear contracts the listing fees payable in one single lump sum upon the application of the listing of such structured product shall be 30% of the Basic Fee above for the first issue launched in any calendar year by an issuer over a particular security, index, currency or other asset and 30% of the Reduced Fee above for any subsequent issues launched in that same calendar year by that issuer over the same underlying security, index, currency or other asset. The fee for baskets shall be 30% of the Basic Fee above for each issue and each subsequent issue. In all cases the listing fee shall be rounded upwards to the nearest HK\$100.

Hong Kong Exchanges and Clearing Limited. http://www.hkex.com.hk/eng/rulesreg/lstrules/mbrules/documents/appendix_8.pdf

Table A1.2 General Debt Securities

General Debt Securities				
Issue Size: above HKD100 million to HKD1,500 million				
Fee (HKD)	Term to Maturity			
	1 Year	5 Years	10 Years	15 Years
Current fee	25,000 – 30,000	50,000 – 60,000	60,000 – 80,000	90,000 – 110,000
Proposed fee	22,000 – 26,000	34,000 – 44,000	54,000 – 74,000	74,000 – 94,000

Table A1.3 Debt Issuance Programme Securities

Debt Issuance Programme Securities				
Issue Size: above HKD100 million to HKD1,500 million				
Fee (HKD)	Term to Maturity			
	1 Year	5 Years	10 Years	15 Years
Current fee	65,000 – 72,000	65,000 – 72,000	72,000 – 86,000	93,000 – 107,000
Proposed fee	31,000 – 34,000	39,000 – 46,000	53,000 – 67,000	67,000 – 81,000

Source: Hong Kong Exchanges and Clearing. <http://www.hkex.com.hk/eng/newsconsul/hkexnews/2002/020308news.htm>

The above proposed revised fee structure for listing of debt securities and debt issuance programmes in Hong Kong is competitive with a major debt listing exchange in Europe.

References

- Market Overview - Asia Capital Markets Association (ACMA)
- Market Profile provided by Citibank
- Deutsche Bank AG Domestic Custody Services, Market Guide
- J.P. Morgan
- State Street Bank

Contact (ADB Consultant):

Prof. Shigehito Inukai
Faculty of Law, Waseda University
1-6-1, Nishiwaseda, Shinjuku-ku, Tokyo, 〒169-8050
Tel & Fax (Direct): + 81-(0)3-3202-2472
Mobile: +81-(0)80-3360-7551
E-Mail: shige.inukai@me.com

Indonesia

Bond Market Guide

Contents

Acknowledgement	vii
I. Structure, Types, and Characteristics of the Market.....	1
A. Overview	1
B. Types of Bonds.....	3
C. Money-Markets Instruments	3
D. Listing of Debt Securities	5
E. Methods of Issuing Bonds	6
F. Public Offering and Private Placement Markets.....	9
G. Professional or Wholesale Market and the Retail Market.....	10
H. Definition of Professionals and Professional Investors	10
I. Credit Rating System.....	10
J. Bond-Related Systems for Investor Protection	11
K. Governing Laws on Bond Issuance.....	13
L. Transfer of Interests in Bonds.....	14
M. Definition of Securities and Public Offering	14
N. Self-Governing Rules behind the Market.....	15
O. Bankruptcy Procedures, Laws and Related Rules	16
P. Meetings of Debt Securities Holders.....	16
Q. Event of Default.....	17
R. Established Principles and Standards	18
S. Parties Involved in Bond Issuance and Their Respective Roles	19
T. Major Players in the Market.....	20
II. Primary and Secondary Market Regulatory Frameworks	21
A. Indonesian Market Regulatory Structure	21
B. Disclosure Requirements	27
C. Credit Rating Requirements	28
D. Exemptions for Private Issuance (Private Placement)	28
E. Minimum Lead Time for Registration Approval	28
F. Availability of Shelf Registration and Associated Documentation Requirements	29
G. Regulated Suspension Period	29
H. Other Requirements	30
I. Rules and Requirements on Continuous Disclosure	31

J. Restrictions for Investors	31
K. Definition of Qualified Institutional Investors and Professional Investors	31
L. Requirements and/or Restrictions for Non-Residents	31
M. Finding a Fair Price	31
N. Taxation Framework and Tax Requirements	32
O. Other Regulatory Reporting Requirements	35
P. Challenges and Expected Changes—Policy Initiatives and Reforms	36
III. Trading and Trading Market Infrastructure of Debt Securities	37
A. Trading and Reporting Platforms.....	38
B. Debt Securities Trading on Exchange	39
C. Over-the-Counter Trading of Debt Securities.....	39
D. Bond Repurchase Market.....	39
E. Debt Securities and Sukuk Trading Mechanism.....	40
F. Pricing Platforms	43
IV. Possible Impediments and Restrictions	45
A. Taxation	45
B. Disclosure and Investor Protection Rules for Issuers	46
C. Underwriting Rules for Financial Institutions.....	47
D. Credit Rating System and Its Relation to Regulations.....	47
E. Utilization of Shelf-Registration System	47
F. Availability of Information in English.....	48
G. Restrictions in Accounting Standard	48
H. Limited Opportunities to Utilize Bond Holdings and the Repo Market.....	48
J. Currency Controls	48
K. Funding Procedures	49
V. Description of the Securities Settlement System	50
A. Securities Settlement Infrastructure.....	50
B. Definition of Clearing and Settlement	53
VI. Cost and Charging Methods	54
A. Market Costs.....	54
B. Registration Costs	55
C. Listing Fees Charged by Exchanges	56
D. Other Costs.....	57
VII. Market Size and Statistics	58
A. Debt Securities and Sukuk Trade Reporting Data through PLTE (Indonesia Stock Exchange)	58
B. Debt Securities and Sukuk Outstanding Data	59
C. Composition of Bond Holding as of September 2011	59
D. Type of investors for bonds as of September 2011	59
E. Size of Local Currency Bond Market in Percentage of Gross Domestic Product	60
F. Trading Volume	61
VIII. Presence of an Islamic Finance (Islamic Bond [Sukuk]) Market	62
A. Definition	62
B. Shari'a Principles	62
C. Rules.....	63

D. Fatwa and the Legal Basis of Islamic Bonds (Sukuk) in Indonesia	63
E. Regulations on Domestic and International Issuance of Government Sukuk	64
F. Statistics	64
IX. History of Debt Market Development	68
A. Corporate Debt Securities	68
B. Government Debt Securities.....	68
X. Next Steps	70
1. Development Plans.....	70
2. Market Development.....	71
3. G-30 Compliance.....	71
4. Group of Experts Final Report: Summary of Barriers Market Assessment (April 2010)	72

Box, Figures, and Tables

Box

Box 2.1	Application of Indonesia's Avoidance of Double Taxation Agreements	34
---------	--------------------------------------------------------------------------	----

Figures

Figure 3.1	Market Infrastructure of Debt Securities in Indonesia	37
Figure 3.2	The Indonesian Fixed-Income Market	40
Figure 3.3	Over-the-Counter Process Flow	42
Figure 5.1	Bond Settlement Infrastructure Diagram of Indonesia.....	50
Figure 5.2	Business Process Flowchart of the Indonesia Over-the-Counter Bond Market on a Delivery-versus-Payment Basis	51
Figures 8.1	The Development of Sukuk Issuance and Outstanding Sukuk (Shari'a Bonds).....	65
Figure 8.2	The Profile of Corporate Sukuk Investors.....	66
Figure 8.3	The Development of Shari'a Mutual Funds	67

Tables

Table 1.1	Characteristics of Sertifikat Bank Indonesia, Government Debt Securities, and Corporate Bonds.....	1
Table 1.2	Profile of Indonesia's Listed Government and Corporate Bonds	2
Table 1.3	Structure of Indonesian Bonds and Commercial Papers.....	5
Table 4.1	Schedule of Submission of Declaration Letter	49
Table 6.1	Stamp Duty Fees for Securities (IDR)	54
Table 6.2	Listing Fees per Type of Debt Securities.....	56
Table 7.1	Listed Bonds (Outstanding), 2008–September 2011 (IDR trillion)	58
Table 7.2	Debt Securities and Sukuk Outstanding Data, 2008–2010 (IDR billion)	59
Table 7.3	Composition of Bond Holdings as of September 2011 (IDR trillion)	59
Table 7.4	Type of Investors of Bonds as of September 2011 (IDR billion)	59
Table 7.5	Size of Local Currency Bond Market (% GDP)	60
Table 7.6	Trading Volume of Government and Corporate Bonds (in USD billion).....	61
Table 8.1	Statistics on the Islamic Finance Market in Indonesia (2007–2011).....	64
Table 10.1	Group of Thirty Compliance Recommendations.....	71
Table 10.2	Summary of Barriers Market Assessment – Indonesia (April 2010)	72

Acknowledgement

The Asian Development Bank (ADB) Team, comprising Satoru Yamadera (Economist, ADB Office of Regional Economic Integration, - September 2011), Seung Jae Lee (Principal Financial Sector Specialist), Shinji Kawai (Senior Financial Sector Specialist, Banking), Shigehito Inukai (ADB consultant), Taiji Inui (ADB consultant), and Matthias Schmidt (ADB consultant) would like to express sincere gratitude to National Members and Expert Institutions: Indonesia Stock Exchange, Indonesian Central Securities Depository (Kustodian Sentral Efek Indonesia, KSEI), Indonesian Clearing Guarantee Corporation (Kliring Penjamin Efek Indonesia, KPEI) and Bapepam-LK. They kindly provided answers to the questionnaires prepared by the ADB team, thoroughly reviewed the draft of Market Guide, and gave them valuable comments.

The ADB team also would like to express special thanks to Citibank, Deutsche Bank AG, Hongkong and Shanghai Banking Corporation, J.P. Morgan and State Street Bank and Trust Company as the international experts for their contribution to provide their market guides information as well as their valuable expertise. Because of their cooperation and contribution, the ADB team started the research on solid ground.

Last but not least, the team would like to thank all the interviewees who gave their comments and responses that were raised during the market consultations.

It should be noted that any part of this report does not represent official views and opinions of any institution which participated in this project as members and experts of the ASEAN+3 Bond Market Forum.

The ADB team has responsibility for the contents of this report.

February 2012

Asian Development Bank (ADB) Team

List of Interviewees:

Jakarta, 9 May 2011

Indonesia Stock Exchange (IDX), KSEI, KPEI

Deutsche Bank AG, Jakarta Branch

HSBC Jakarta

Bank Indonesia

Jakarta, 10 May 2011

Bapepam-LK

Mochtar, Karuwin, Komar (law firm)

I. Structure, Types, and Characteristics of the Market

A. Overview

Indonesia's bond market has grown steadily in recent years to offer a more diversified array of debt instruments and cater to a broader investor base. The market accommodates the needs of both local and foreign investors. In addition to its position as one of the most attractive market for foreign investors, the potential of growing local investors is also an area that can be cultivated further by local and foreign issuers alike.

As the largest issuer of bonds, the Government of Indonesia regularly taps the local market to finance the state budget. The Indonesia government bond forms vary from conventional and retail government bonds to government *sukuk* in several tenors.

Corporate bonds are also available in similar forms with government or conventional bonds and *sukuk*. Corporate-bond and *sukuk* activities have accelerated significantly since the beginning of 2003 and have maintained momentum since then. Although both government and corporate bonds are listed on the Indonesia Stock Exchange (IDX), they are mostly traded Over-the-Counter (OTC). Bank Indonesia (BI) also issues short-term bank certificates known as Certificate of Central Bank (or Sertifikat Bank Indonesia [SBI]). Table 1.1 summarizes the characteristics of SBI, government bonds (government debt securities), and corporate bonds.

Table 1.1 Characteristics of Sertifikat Bank Indonesia, Government Debt Securities, and Corporate Bonds

Items	SBI	GS			Corporate Bonds
		Regular GS	Retail GS	SPN/SPNS	
Form	Scriptless	Scriptless			All scriptless
Tenor	Used to be 1 and 3 months	2–30 years	3 years	1 to 12 months	Currently 1–15 years, mostly 5 years
Issuer	Bank Indonesia	Ministry of Finance			Corporation
Coupon/Discount	Discount	Fixed Rate: Semi-annually coupons Variable Rate: Quarterly coupons	Fixed Rate: Monthly coupons	Discount	Depends on company, mostly quarterly coupons

continued on next page

Table 1.1 continuation

Items	SBI	GS			Corporate Bonds
		Regular GS	Retail GS	SPN/SPNS	
Minimum denomination	IDR1 billion Increments IDR100 million and IDR1 million (in Secondary Market)	IDR1 billion Increments of IDR100 million and IDR1 million (in Secondary Market)	IDR5 million Increments of IDR5 million (in Primary Market) and IDR1 million (in Secondary Market)	IDR1 billion Increments of IDR100 million and IDR1 million (in Secondary Market)	Depends on the company
Issuance	Competitive auction	Competitive auction	IPO	Competitive auction	IPO
Trading	OTC	OTC and on-the-exchange (FITS)	OTC and on-the-exchange (FITS)	OTC	OTC and on-the-exchange (FITS)
Settlement	Primary Market: T+1 Secondary Market: T+2 - T+3 (Negotiable)	Primary Market: T+2 Secondary Market: T+2 - T+3 (Negotiable) for OTC, and T+2 for on-the-exchange (FITS)	Primary market: T+2 Secondary Market: T+2 - T+3 (Negotiable) for OTC, and T+2 for on-the-exchange (FITS)	Primary Market: T+1 Secondary Market: T+2 - T+3 (Negotiable)	T+2-T+3 (Negotiable) for OTC, and T+2 for on-the-exchange (FITS)
Interest calculation	Discount	Actual/Actual	Actual/Actual	Actual/Actual	Depends on the company, mostly 30/360
System used for settlement	BI-SSSS	BI-SSSS	BI-SSSS	BI-SSSS	C-BEST

BI-SSSS = Bank Indonesia-Scriptless Securities Settlement System; C-BEST = Central Depository and Book-Entry Settlement; FITS = Fixed-Income Trading System; GS = government securities; IPO = initial public offering; OTC = Over-the-Counter; SBI = Sertifikat Bank Indonesia; SPN = Surat Perbendaharaan Negara; SPN-S = Surat Perbendaharaan Negara-Syariah; T = trade
 Source: HSBC Indonesia Market Guide, 2010.

Table 1.2 gives an overview of the profile, or the main characteristics, of listed government bonds and corporate bonds in Indonesia.

Table 1.2 Profile of Indonesia's Listed Government and Corporate Bonds

Indonesian Rupiah Government Bonds	
– Issuer : The Republic of Indonesia (MOF) – Types : <ul style="list-style-type: none"> • FRB and VRB – listed and tradable • Stapled Bonds (exchanged bonds for FRBs) – listed and tradable • Hedge Bonds – non-tradable • IPB – guarantee program (non-tradable) • Credit program for SMEs (non-tradable) Listed and Tradable Government Bonds : <ul style="list-style-type: none"> – Time to maturity : less than 1 year up to 17 years – Coupon payment : semi-annually – Coupon structure : fixed and floating (SBI 3 months) – Settlement : Bank Indonesia (central bank) – book-entry settlement – Listing : IDX – Trading : OTC and Exchange (IDX) 	
Indonesian Rupiah Corporate Bonds	
– Issuer : state owned, private, and public companies – Types : mostly straight bonds, sukuk, and convertible bonds – Time to maturity : 1 year up to mostly 10 years – Coupon payment : mostly quarterly, semi-annually, and annually – Coupon structure : fixed and/or floating – Settlement : Indonesian Central Securities Depository: book-entry settlement for scripless bonds – Custodian banks : physical delivery for scrip base bonds – Listing : IDX – Trading : OTC and Exchange (IDX)	
FRB = Fixed-Rate Bonds; IDX = Indonesia Stock Exchange; IPB = Indexed Principle Bonds; MOF = Ministry of Finance; OTC = Over-the-Counter; SBI = Sertifikat Bank Indonesia; SMEs = small and medium enterprises; VRB = Variable Rate Bonds Source: IDX (Surabaya Stock Exchange, 2005) and amended by ADB Consultants.	

B. Types of Bonds

1. Government Bonds

Government bonds consist of two types of bonds and *sukuk*.

a. Treasury bonds (T-bonds)

According to *Law No. 24 2002* on government debt securities, government bonds are the kind of government debt securities that mature after more than 12 months. Since 2002, the government represented by the Minister of Finance has issued different types of bonds based on this law since the government has flexibility to issue any type of bonds that meet market preferences. Based on this law, the government has issued various domestic bonds including coupon and zero-coupon bonds; fixed- and floating-rate bonds; and tradable and non-tradable conventional and retail bonds with different maturities from short, medium, and long-end maturity bonds. In addition, domestic bonds outstanding still consist of non-tradable promissory notes that are issued related to the banking liquidity support and guarantee program during the financial crisis in 1998. For foreign-denominated bonds, the government has launched the US dollar global conventional, US dollar global *sukuk*, and yen-denominated bonds, namely Samurai bonds.

b. Sovereign Shari'a Securities (Sukuk or Surat Berharga Syariah Negara)

Sovereign Shari'a securities called Surat Berharga Syariah Negara (SBSN), or Sukuk Negara, are bonds issued by the government based on Shari'a principles in rupiah or foreign currency.

2. Municipal Bonds

Municipal bonds are issued by the province or district government for financing public utilities projects.

3. Corporate and/or Public Bonds

- a. Corporate Bond and Medium-Term Note (MTN)
- b. Corporate Sukuk
- c. Convertible Bonds

The term MTN is rarely used in Indonesia. MTN, which is issued according to the definition of public offering in the *Indonesia Capital Market Law*, is considered a corporate bond.

C. Money-Markets Instruments

1. Treasury Bills (Surat Perbendaharaan Negara)

Surat Perbendaharaan Negara (SPN) are widely known as Treasury bills, a short-term note issued by the government and sold on discount. Its maximum maturity is 12 months. Currently, the government regularly offers 3-month and 12-month SPN at every auction.

2. Islamic Treasury Bills (Surat Perbendaharaan Negara-Syariah)

Surat Perbendaharaan Negara-Syariah (SPN-S) is similar to SPN, which is issued by the government, sold on discount, and with a maximum maturity of 12 months. The government issued the first SPN-S in early August 2011 with a 6-month tenor.

3. Certificate of the Central Bank (Sertifikat Bank Indonesia)

SBI was issued in two tenors (28 days and 3 months) by BI. Prior to the advent of treasury bills, SBIs were the main tool used by BI for open-market operations and to control the liquidity of the banking system. SBIs were the most actively traded money-market instrument in Indonesia.

Beginning in June 2010, SBI certificates were auctioned on a monthly basis with maturities of 28, 91, and 182 days. In addition, BI also issued a 28-day Shari'a-compliant SBIs on a monthly basis. In November 2010, BI stopped issuing 3-month SBIs and began offering term-deposit instruments to absorb excess bank liquidity. Subsequently, in February 2011, BI announced that it would no longer issue SBIs with maturities less than 9 months.

4. Commercial Paper

Commercial paper is the short-term securities in the money market with no guarantee, issued with discount by companies. Usually these instruments are not used for long-term investment but rather just for funding purchased inventory or to manage working capital. Normally, all these instruments are purchased by financial institutions because the face value is too large for private investors, and these are included in a very safe investment so that the yield of commercial paper is also low. Since the maturity of commercial paper does not exceed 9 months, and it is used only for the purpose of payment transactions, the offering of commercial paper was excluded from the obligation to submit a registration statement to Bapepam-LK.

CPs grew rapidly in the early 1990s as they offered a substitute for bonds. Since CP programs can be rolled over almost automatically, they are economically the same as floating-rate bonds, but involve less cost and effort.

The market received a further boost in September 1994, when Bapepam introduced a requirement that bonds (i.e., not CP) could be listed only for rated companies, although it did not specify a minimum rating. But just over a year later, a similar requirement for CP introduced by the BI effectively stifled the market. A central bank regulation in 1996 put a stop to the growth of the CP market. According to the regulation, Indonesian banks could arrange, invest in, or act as paying agent only for CP issues that were rated investment grade. Outstanding CP shrank from a peak of about IDR10 trillion in 1995 to IDR5.9 trillion in 1996 and IDR0.8 trillion in 1997. The most affected CP issuers were finance and property companies which, in 1995, were the two major issuers of CP representing about 32% of the total market. As a result, many companies switched their funding sources to other instruments, particularly offshore MTNs and FRNs. Table 1.3.3.3 provides the structure of Indonesian bonds and commercial papers (CPs).

Table 1.3 Structure of Indonesian Bonds and Commercial Papers

Items	Corporate Bonds	Commercial Paper
Tenor	Mostly 5 years	Less than 270 days
Currency	Rupiah, US dollar, and other foreign currencies	Rupiah and US dollar
Structure	Fixed and floating rates; mostly guaranteed	Zero coupon with bullet payment on maturity; clean if guaranteed
Rating requirement	Yes, as of September 1996	Yes, as of February 1996
Method of calculation	Yield-to-maturity	True discount
Others	Pari passu with other unsecured indebtedness	Pari passu with other unsecured indebtedness

Source: Farid Harianto. 1999. Chapter 3, The Mortgage-Backed Securities Market in Indonesia from publication 'Mortgage-Backed Securities Markets in Asia', Asian Development Bank, Manila, 1999.

5. Repurchase Agreement

Indonesia's repurchase market is jointly managed by BI, the Indonesian Securities Inter-Dealer Association, and the Indonesian Fixed-Income Dealer Association. BI has established provisions for secondary market trading of SBI notes under repurchase agreements (repo). The government launched a repo market in 2004 and a Master Repurchase Agreement (MRA) in 2005. The MRA is the benchmark for repurchase transactions, which are set at the BI rate plus 3% for overnight repurchases.¹

D. Listing of Debt Securities

Listing on the stock exchange is not mandatory. Issuers are to determine by themselves whether they would list the securities on the exchange or not. There is, however, obligation to disclose the plan in the prospectus whether the securities would be listed on the exchange or not.

Trading of bonds are via both exchange and Over-the-Counter (OTC), although most of trading is executed OTC. In June 2005, the Surabaya Stock Exchange introduced the Fixed-Income Trading System (FITS) to facilitate the trading of bonds on the exchange. After the exchange merged with the Jakarta Stock Exchange and became the IDX, the system still exists.

In the wake of a new regulation promulgated in August 2006, Bapepam-LK obliged reporting on bond transactions both done on the exchange and OTC, and appointed the stock exchange as the Beneficiary of Bond Transaction Report. The regulation took effect on 1 September 2006, and all government bonds and corporate bonds transactions must be reported to Bapepam-LK through the stock exchange system, no later than 1 hour after bond transaction.

As the trading repository, IDX must help disseminate the reported bond information (prices, volumes, etc.). The information then could be used by the market as a price reference for various purposes.

¹ Bank Indonesia. <Insert year of publication. *Banking Regulation*. http://www.bi.go.id/web/en/Peraturan/Moneter/se_100208.htm; Bank Indonesia. <Insert year of publication. *Tabel IV-1. Transaksi Pasar Yang*. <http://www.bi.go.id/biweb/Html/SekiTxt/T3x401.txt>; Bapepam-LK. Peluncuran Master Repurchase Agreement (MRA). http://www.bapepam.go.id/pasar_modal/publikasi_pm/info_pm/warta/2005_juni/mra.pdf

On 29 May 2009, the regulation was amended and took effect on 1 October 2009 to include sukuk transaction reporting and to shorten the reporting period to 30 minutes.²

E. Methods of Issuing Bonds

1. Government Bonds (SUN and Surat Berharga Syariah Negara)

Under *Law No. 24 2002* on government debt securities (SUN) and *Law No. 19 2008* on sovereign Shari'a securities (also known as SBSN), the authority to issue government securities (or SBN), consisting of SUN and SBSN, lies with the government represented by the MOF. The MOF should consult with BI prior to executing the government securities issuance program every year. The issuance program considers the maximum net SBN issuance approved by Parliament. In addition, payment of all interest and principal obligations arising from the issuance of SUN, or payment of total obligations of benefits, and par value arising from SBSN issuance and the state property, are SBSN's assets. The issuance and offering of government securities including SUN and SBSN may be conducted through auction, book building, and private placement in the local or international primary markets.

a. Related Finance Minister Regulations for Issuing and Offering Bonds

Related Finance Minister Regulations for issuing and offering bonds are enumerated below:

- i. *PMK No. 217/PMK.08/2008* regarding foreign-denominated government debt securities sale in the international primary market, which is amended by *No. 32/PMK.08/2009*
- ii. *PMK No. 67/PMK.08/2009* regarding yen-denominated government debt securities sale in the primary market in Japan, which is amended by *PMK No. 122/PMK.08/2009*
- iii. *PMK No. 118/PMK.08/2008* regarding domestic sukuk issuance in the primary market through book building
- iv. *PMK No. 11/PMK.08/2009* regarding the issuance and sale of sovereign Shari'a securities in the domestic primary market through auction
- v. *PMK No. 152/PMK.08/2008* regarding sovereign Shari'a securities issuance in foreign currency-denomination in the international market, with changes stipulated in *PMK No. 129/PMK.08/2009*
- vi. *PMK No. 75/PMK.08/2009* regarding issuance and sale of sovereign Shari'a securities through private placement

b. Related Finance Minister Regulations for Domestic Issuance and International Issuance

There are two types of government debt securities offering and issuance—domestic issuance and international issuance. Each method is governed by a corresponding Finance Minister Regulation as follows.

² Bapepam-LK. 2009. Bapepam-LK Rule Number X.M.3 on "Bond Transaction Reporting."

i. Domestic Issuance

1. Auction of T-bills and T-bonds, twice a month based on calendar of issuance: *Finance Minister Regulation No. 50/PMK.08/2008* on government debt securities auction in the primary market;
2. Bookbuilding for retail bonds: *Finance Minister Regulation No. 36/PMK.06/2006* regarding retail governments bonds sale in the primary market) further revised by *Finance Minister Regulation No. 10/PMK.08/2007* and *Finance Minister Regulation No. 172/PMK.08/2010*;
3. Private placement for specific securities: *Finance Minister Regulation No. 08/PMK.08/2009* regarding government debt securities private placement sale in the domestic primary market;
4. Bookbuilding for sovereign sukuk: *Finance Minister Regulation No. 118/PMK.08/2008* on issuance and sale of SBSN in the domestic primary market through bookbuilding;
5. Bookbuilding for sovereign retail sukuk: *Finance Minister Regulation No. 218/PMK.08/2008* on issuance and sale of retail SBSN in the domestic primary market;
6. Auction of sovereign Shari'a securities: *Finance Minister Regulation No. 11/PMK.08/2009* concerning issuance and sale of SBSN in the domestic primary market through auction; and
7. Private placement of sovereign Shari'a securities: *Finance Minister Regulation No. 75/PMK.08/2009* concerning issuance and sale of SBSN through private placement.

Since May 2009, the Republic of Indonesia has issued several SBSN through private placement with the Ministry of Religion, under *aqad of Ijarah al Khadamat*, which are considered non-tradable sukuk. The sukuk underlying are hajj services, covering accommodations, transportation, and consumption for hajj.

ii. International Issuance

1. Bookbuilding or public offering and private placement for global bonds: *Finance Minister Regulation No. 217/PMK.08/2008* regarding foreign-denominated government debt securities sale in the international primary market further revised by *Finance Minister Regulation No. 32 /PMK.08/2009*, *No. 170 /PMK.08/2009* and *No. 34/PMK.8/2011*.
2. Public offering and private placement for samurai bonds: *Finance Minister Regulation No. 67/PMK.08/2009* regarding yen-denominated government debt securities sold in the primary market in Japan further revised by *Finance Minister Regulation No. 122 /PMK.08/2009*.
3. Bookbuilding sovereign Shari'a securities: *Finance Minister Regulation No. 152/PMK.08/2008* concerning SBSN issuance in foreign-currency denomination in the international primary market with changes reflected under *Finance Minister Regulation No. 129/PMK.08/2009*; and,
4. Private placement of sovereign Shari'a securities: *Finance Minister Regulation No. 75/PMK.08/2009* concerning issuance and sale of SBSN through private placement.

2. Corporate Bond and Sukuk

a. Submission of Registration Statement to Conduct Public Offering

Issuers have to submit a Registration Statement and supporting documents according to Bapepam-LK regulations on public offering registration procedures.³ Issuers are fully responsible for the accuracy, adequacy, truthfulness, and fairness of all information contained in the registration statement and its supporting documents. Underwriters, capital market support professionals such as lawyers and accountants, and other parties involved who provide advice and/or information contained in the registration statement are responsible for their statements and opinions.

b. Request for Amendment and/or Additional Information

Bapepam-LK could request for amendment and/or additional information from issuers, and issuers have to deliver the amendment and/or additional information to the Registration Statement no later than 10 working days after the issuer has received the request from Badan Pengawas Pasar Modal dan Lembaga Keuangan (Bapepam-LK).

c. Publication of Summary Prospectus, Prospectus, and Preliminary Prospectus

After the document has been completed, with or without a request for amendment and/or additional information, Bapepam-LK gives permission for the publication of the Summary Prospectus and issuers have to publish it within 2 working days at least in one Indonesian-language newspaper. When issuers would like to do bookbuilding, bookbuilding could only be done after Bapepam-LK gives a statement that issuers are allowed to undertake the bookbuilding.

d. Effectivity of Registration Statement

The Registration Statement becomes effective 45 days from the date the completed Registration Statement is received by Bapepam-LK, or from the date of last change requested by Bapepam-LK is received, or the issuance of effective notice from Bapepam-LK that there is no further need for amendment and/or additional information.

e. Publication of Revision of and/or Additional Summary Prospectus

Once the Registration Statement becomes effective and before the commencement of the public offering period, issuers have to publish any revision to and/or additional Summary Prospectus concerning additional information and effective date within 1 working day in at least one Indonesian-language newspaper upon effectivity of the Registration Statement. Along with the publication of additional information, issuer could do the public offering.

f. Period of Public Offering, Allotment, and Report on the Result of Initial Public Offering

In order to perform public offering, securities could be offered by an underwriter with assistance from a securities-selling agent. Issuers are obliged to execute public offering within 2 working days when the Registration Statement becomes effective. The period of public offering is at least 1 working day and a maximum of 5 working days. In the event of termination of trading on the stock exchange for at least 1 trading day

³ The following *Bapepam-LK Rules* apply to public offering registration procedures: 1) Number IX.A.2 on Public Offering Registration Procedure, 2) Number IX.A.1 on General Procedure Regarding Submission of Registration Statement, 3) Number IX.A.13 on Issuance of Shari'a Securities, and 4) Number IX.C.1 on Guidelines Regarding Form and Content of Registration Statement for Public Offering.

during the offering period, the issuer can make an extension of the offering period to cover the period of termination.

Subscriptions to securities in a public offering should be fully paid no later than the time of securities' delivery. Listing of securities offered in a public offering should be done no later than 1 working day following the date of securities' delivery. The underwriter or issuer (if there is no underwriter) shall submit a Report on Result of Public Offering to Bapepam-LK no later than 5 working days after the date of allotment, along with an Allotment Report. The underwriter or issuer (if there is no underwriter) shall appoint an accountant registered with Bapepam-LK to conduct a special audit on whether the funds have been received by the issuer. These are governed by *Bapepam-LK Rules No. IX.A.7 on Responsibilities of Underwriters with Respect to Subscription and Allotment of Securities in a Public Offering* and *No. IX.A.2 on Public Offering Registration Procedure*.

g. Shelf Registration

Shelf registration, also called sustainable public offering, is a public offering for debt securities and/or sukuk, which is done continuously to enable the issuer or public company with good performance to make a public offering of debt securities and/or sukuk within a period of time. Shelf registration should be implemented no longer than 2 years upon the effectivity of the Registration Statement with certain criteria for both the issuer and securities. Shelf registration is covered under *Bapepam-LK Rules No. IX.A.15 on sustainable public offering*.

F. Public Offering and Private Placement Markets

1. Public Offering Market

a. Auction

Auction is used for public offering of government securities. Each party could invest in the primary market through auction, which could only be done through primary dealers or auction participants for SUN or SBSN. Auction is conducted by entering competitive and/or non-competitive bids during a predetermined bidding period via a system provided by an agent who conducts the auction of SUN or SBSN.

Auction of short-term SPN or SPN-S can be monitored by auction participants, BI, and/or Lembaga Penjamin Simpanan (LPS). Meanwhile, auction of long-term government bonds (*Obligasi Negara*), or SBSN, can be monitored by auction participants and/or LPS.

For government bonds, participants in the auction are banks or securities companies appointed by the Minister of Finance as primary dealers, which are entitled to several rights and obligations. However, for the auction of government sukuk (SBSN), banks and securities companies are appointed by the Minister of Finance only as auction participants, not as primarily dealers.

b. Bookbuilding

i. Surat Berharga Syariah Negara

The issuance and offer for sale of SBSN could be done through bookbuilding during a specified period. Any individual, or group, and/or wealth organized either in the form of corporation or non corporation could propose an offer of SBSN via bookbuilding.

ii. Corporate Bond

In case an issuer intends to conduct bookbuilding, it could only be done after Bapepam and LK gives statements that state that the issuer has been allowed to conduct bookbuilding within 21 working days as provided in *Bapepam-LK Rules No. IX.A.2* on Public Offering Registration Procedure.

2. Private Placement Market

The issuance and offer for sale of SBN or SBSN could be done by through private placement at domestic and international markets. Finance Minister regulations are the same as those governing the methods of issuing bonds (see Part E).

G. Professional or Wholesale Market and the Retail Market

1. Professional (wholesale) market

Trading in the professional market is usually done OTC, and is subject to reporting obligations to the market regulator.

2. Retail market

Both retail SUN and sukuk are sold to individual Indonesian citizens through a selling agent in the domestic primary market. This retail market has been established since 2006 with the launch of the first retail bonds, ORI001, to the public through bookbuilding.

H. Definition of Professionals and Professional Investors

Indonesia does not have specific definitions on this type of investors.

I. Credit Rating System

Debt securities to be offered through public offering should obtain a rating from a credit rating agency (CRA) licensed by Bapepam-LK. Rating is an opinion from a CRA concerning the ability of the rated party to meet its obligations in a timely manner (company rating) and/or an opinion related to the securities issued (instrument rating). Ratings could be done for:

- a. Debt securities, sukuk, asset-backed securities, or other rated securities; and
- b. Parties as entities, including mutual funds and real estate investment trust in a form of a Collective Investment Contract.

A CRA is licensed by Bapepam-LK, and, thus, comes under its supervision and monitoring. To obtain a license, a CRA should fulfill certain requirements such as capital and internal control. PT ICRA Indonesia, PT Pemeringkat Efek Indonesia, and PT Fitch Ratings Indonesia are the existing CRAs in Indonesia. The following Bapepam-LK Rules govern the credit rating system (CRS):

- i. *No. IX.C.11: Rating of Debt Securities*
- ii. *No. V.C.2: Licensing of Rating Agency*
- iii. *No. V.H.3: Behavior of Rating Agency Companies*
- iv. *No. V.H.4: Ranking Agreement Guidelines*
- v. *No. X.F.4: Company Reports Rating Agency*
- vi. *No. X.F.5: Document Maintenance Company by Rating Agency*
- vii. *No. X.F.6: Publications by Rating Agency Companies*

Further information on Indonesia's CRS and CRAs can be found in ADB's Asia Bonds Online.⁴

J. Bond-Related Systems for Investor Protection

1. Paying Agent (Fiscal Agent)

The Indonesia Central Securities Depository (CSD, or Kustodian Sentral Efek Indonesia [KSEI]) is the paying agent for corporate bonds and sukuk, while BI serves this function for government bonds. A paying agency (or fiscal agent) agreement is executed between the issuer and the paying agent with KSEI as the principal paying agent of the issuer for corporate bonds. The issuer pays the interest or the principal to the paying agent, and the paying agent pays the amount of interest or principal to the bondholders. Investors receive the net amount of interests after having been deducted with the withholding tax. Investors are required to submit proper tax documentation to KSEI for them to ensure of the deduction of the proper tax rates.

Upon the maturity of bonds, investors are required to provide KSEI with their purchase price of the bonds for KSEI to deduct the capital gain withholding tax at the point of redemption. The responsibility to make the tax payment to the tax authority remains with the issuer, and therefore KSEI will provide the detailed information and documents to the issuer for each interest or redemption payment.

The paying agent also keeps the records of payments on the bonds as a registrar and reports on payment failure. As the agent of the issuer, it does not represent the interests of the bondholders.

2. Trustee

Trustees represent the interest of debt securities and sukuk holders both inside and outside the court. The authority to represent such holders is granted without a power of attorney. Trustee activities can be conducted by commercial banks and other parties defined by government regulations. To conduct activities as a trustee, a public bank or other parties must be registered first with Bapepam-LK. The requirements and procedures for registration of trustees are stipulated in *Bapepam-LK Rule No. VI.C.2: Registration of a Commercial Bank as a Trustee*. The trustee (which is a bank) is the

⁴ AsiaBondsOnline.http://asianbondsonline.adb.org/indonesia/structure/participants/rating_agencies.php

representative of the bondholders and exercises bondholders' rights and monitors the performance of the issuer of its obligations under the bonds.

a. Main Functions and Responsibilities of Trustees

Under *Bapepam-LK Rule No. VI.C.3: The Credit and Guarantee Relationship between the Issuer and Trustee*, the functions and responsibilities of trustees are as follows:

- i. To represent the interest of bondholders, both inside and outside the court in accordance with the Trustee Contract and regulations.
- ii. To bind itself to carry out the main duties and responsibilities mentioned above since the signing of the Trustee Contract with the issuer; however such representation shall be effective at the time the debt securities have been already allocated to the investors.
- iii. To perform duties based on the Trustee Contract (or Trust Deed) and other related documents.
- iv. To provide all information in relation with its duties as trustee to Bapepam-LK.

b. Prohibitions for Trustees

Trustees must not be affiliated with the issuers, unless the affiliation occurs due to ownership or capital investment by the government. In conducting capital market activities, trustees must also not:

- i. have a credit relationship with issuers amounting to more than 25% of the debt securities and/or sukuk being trusted, and/or
- ii. be a guarantor and/or collateral provider in issuing debt securities, sukuk, and/or issuer's obligation, and, at the same time, be a trust agent of the securities holder.

The prohibitions ensure that trustees carry out their functions independently to protect the interest of debt securities or sukuk holders. For the duration of the Trustee Contract, the trustee is prohibited from receiving or requesting advance payment from the issuer.

c. Duties of Trustees

The following are the duties of trustees as stipulated in the *Bapepam-LK Rule No. VI.C.3: The Credit and Guarantee Relationship between the Issuer and Trustee*:

- i. The issuer and trustee must make a Trustee Contract in accordance with the stipulation set out in the rule issued by Bapepam-LK.
- ii. A trustee must provide compensation to debt securities or sukuk holders for losses due to its negligence in performing its duties set forth in the *Capital Market Law* and its implementing regulations, or under the terms of the Trustee Contract.
- iii. Once registered with Bapepam-LK, trustees must meet the obligations set forth in the regulations of Bapepam-LK regarding the report of the trustees and documents to be maintained by the trustees.⁵

The Trustee Contract with the issuer shall be made by the trustee to protect and represent Debt Securities holdings and sukuk holders' rights. The contract also

⁵ These rules are *Bapepam-LK Rule Number VI.C.4: General Provision and Trustee Contract of Debt Securities, Number XI.1.1: Trustee Report, and Number XI.1.2: Documents [Maintained] by Trustee*.

contains provisions in the event of a default as well as the settlement procedures and the authority of the trustee in appointing capital market support professionals to assist in the investigation in case of differences in understanding the event of a default.

3. Trade Protection

The Indonesian Clearing and Guarantee Institution (Kliring Penjamin Efek Indonesia [KPEI]) guarantees the settlement of trades executed through the stock exchange. OTC trades, however, are not guaranteed.

Investors are encouraged to open sub-accounts at the central depository through custodian banks or securities companies for identification and protection of their assets.

K. Governing Laws on Bond Issuance

Bonds issued by an Indonesian company or the Government of Indonesia through public offering and listed on the IDX shall be governed by the laws of the Republic of Indonesia. Finance Minister regulations are the same as those for methods of issuing bonds (see Part E). Issuance of municipal bonds and corporate bonds, however, is governed by a specific set of rules and regulations.

1. Municipal Bonds

Issuance of municipal bonds is governed by the following laws and rules:

- i. Law No. 33 (2004) on Fiscal Balance between Central and Local Government
- ii. Ministry of Finance Decree No. 147 (2006) on Procedures for Issuance, Accountability, and Information Publication of Local Government Bonds
- iii. Bapepam-LK Rule No. IX.C.12 on Guidelines of the Form and Content of Registration Statement for Municipal Bond Public Offering
- iv. Bapepam-LK Rule No. IX.C.13 on Guidelines of the Form and Content of a Prospectus for Municipal Bond Public Offering
- v. Bapepam-LK Rule No. IX.C.14 on Guidelines of the Form and Content of Summary Prospectus for Municipal Bond Public Offering

2. Corporate Bonds

The regulations and Bapepam-LK rules for the issuance of corporate bonds are stipulated under the following:

- i. Law No.8 (1995) on Capital Market
- ii. Rule No. IX.A.1 on General Requirements Regarding Submission of a Registration Statement
- iii. Rule No. IX.A.2 on Public Offering Registration Procedure
- iv. Rule No IX.A.7 on Responsibilities of Underwriters with Respect to Subscription and Allotment of Securities in a Public Offering
- v. Rule No IX.A.8 on Preliminary Prospectus and Information Memorandum
- vi. Rule IX.A.13 on Issuance of Shari'a Securities
- vii. Rule No. IX.A.11 on Public Offerings of Debt Securities Denominated in Foreign Currency
- viii. Rule No.IX.A.15 on Continuing Public Offering (Shelf Registration)

- ix. *Rule No. IX.C.1* on Form and Content of a Registration Statement for a Public Offering
- x. *Rule No. IX.C.2* on Guidelines [on] the Form and Content of a Prospectus for a Public Offering
- xi. *Rule No. IX.C.3* on Guidelines Concerning the Form and Content of a Summary Prospectus for a Public Offering

L. Transfer of Interests in Bonds

In general, the transfer of entitlement and ownership of scripless securities is considered completed if the related transaction status is reflected as “Settled” in CSD’s system. In case of a receipt transaction, the holding status of the scripless securities in the securities account maintained in the CSD is reflected as “Available”. The third-party entitlement will be ensured by showing the holding position in the accounts maintained with the CSD or in the holding confirmation issued by the CSD.

1. Indonesian Central Securities Depository for Scripless, Debt Securities and Sukuk

For scripless shares, debt securities and sukuk, KSEI maintains the records of investors’ assets in an electronic book-entry system as the domestic CSD. Securities transferred to the depository system are automatically registered without any additional documentation. In the books of the issuers, the securities are registered in the names of the account holders maintained in the depository. The issuers receive regular update on the bondholders’ list from KSEI for their scripless securities while maintaining the administration of physical securities, which are registered under the name of the securities holders.

2. Bank of Indonesia for Scripless Government Bonds and Certificate of Bank Indonesia

BI, as the central registry for government bonds and SBI, maintains an electronic registration of the sub-registries positions; each sub-registry in turn maintains the account details of each beneficial owner.

SBI is normally settled on T+1. For government bonds, the settlement cycle in the secondary market is T+2 or as agreed between parties involved. Settlement of government bonds and SBI is through BI-SSSS, a system to facilitate online settlement transactions between the sub-registries.

M. Definition of Securities and Public Offering

Pursuant to *Law No. 8 (1995) concerning capital markets (or the Capital Market Law)*, securities are promissory notes, commercial papers, shares, bonds, evidences of indebtedness, participation units of collective investment contracts, futures contracts related to securities, and all derivatives of securities. Pursuant to the “Elucidation of the *Capital Market Law*,” a derivative is derived from either debt or equity securities, such as option and warrant. An option is the right to purchase or sell within a certain time a specified number of securities at a specified price. A warrant is a security issued by a company giving the holder the right, for 6 months or more after the securities are issued, to subscribe to shares of the company at a specified price.

Securities under Bapepam-LK supervision coverage based on Art. 70 of the *Capital Market Law* are all securities that have been offered through public offering. Public offering is an offer to sell securities to the public and is made by an issuer in ways stipulated under the *Capital Market Law* and its implementing regulations (CML Art. 1, No.15). This is explained further in its Elucidation:

“Public Offering” refers to an offering of Securities that takes place within a certain time and within specified amounts, either within the territory of Indonesia, or to Indonesian citizens abroad, and offered either through the mass media, or otherwise to more than one hundred Persons, or resulting in sales to more than fifty Persons.” An “Offering” within the territory of Indonesia includes both domestic and foreign Issuers, as well as offerings to both domestic and foreign investors, in compliance with Disclosure Principles. Regulations regarding Public Offerings also apply to offerings by domestic Issuers to Indonesian citizens abroad. This provides necessary protection to Indonesian investors overseas in the case of Securities offered by domestic Issuers.

In determining whether there has been an offering of Securities to more than one hundred Persons, it is not relevant that the offering is followed by the purchase of Securities. However, the sale of Securities to more than fifty Persons is determined by the actual purchase of Securities, whether or not associated with an offer. “Mass media” refers to newspapers, magazines, film, television, radio and other electronic media, as well as letters, brochures and printed matter distributed to more than one hundred Persons. The number of one hundred offerees and fifty purchasers, used to determine a Public Offering, may be adjusted by BAPEPAM in response to Capital Market developments.

N. Self-Governing Rules behind the Market

The following entities are Self-Regulatory Organizations (SROs):

1. The Indonesia Stock Exchange (IDX)
2. The Indonesian Clearing and Guarantee Institution (KPEI)
3. The Indonesian Central Securities Depository (KSEI)

These three SROs regulate the listing, trading, clearing and settlement of listed bonds when transacted on the exchange. Each regulates its own areas of operations, subject to Bapepam-LK approval.

The Indonesia bond market has one market association called the Inter-Dealer Market Association for Government Securities (HIMDASUN). HIMDASUN holds a license as a market operator for government bonds with self-governing rules, such as membership, trading, surveillance, and master repurchase agreement rules. However, the market operator and self-governing rules functions of HIMDASUN are currently inactive.

O. Bankruptcy Procedures, Laws and Related Rules

Law No. 37 (2004) on bankruptcy and suspension of payment states that requirements and decisions to declare bankruptcy must meet the following conditions:

1. Debtor has two or more creditors and is unable to fulfill its obligations on at least one debt on maturity date and its payables,
2. Debtor has been declared bankrupt by court decisions, either upon its own application or upon the request of one or more creditors.

In case the debtors are banks, a bankruptcy petition could only be requested by BI. If the debtors are securities companies, stock exchanges, clearing and guarantee institutions, and the Central Securities Depository, only Bapepam-LK could request for bankruptcy petition. If debtors are insurance companies, reinsurance Companies, pension funds, or state-owned enterprises involved in public interest, only the Minister of Finance could request for bankruptcy petition.

The party, as set in Art. 85 of the *Capital Market Law*, who requests for bankruptcy petition to the court towards an issuer, has to report it to Bapepam-LK and the stock exchange where the issuer's securities are listed as soon as possible and no later than 2 working days from the date the request for bankruptcy is submitted. According to *Bapepam-LK Rules No. X.K.5: Regarding Disclosure of Information Regarding Issuers or Public Company with Respect to Bankruptcy*, an issuer that fails or is not been able to avoid failure to fulfill its obligations towards a non-affiliated creditor has to submit a report concerning its condition to both Bapepam-LK and the stock exchange where its securities are listed as soon as possible, no later than the second working day since the issuer has failed or not able to avoid failure to fulfill its obligations. The report has to include the details about the loan including the amount of principal and interest, loan terms, name of creditors, purpose of loan and reasons for the failure or inability to avoid failure. In the event the issuer or public company is submitted to the court for a declaration of bankruptcy, the issuer or public company must submit a report regarding the matter to Bapepam-LK and the stock exchange(s) where its securities are listed as soon as possible, but not later than 2 working days from the time the issuer or public company learns of the petition for a declaration of bankruptcy. The stock exchange shall publish the information about the issuer or public company being requested for declaration of bankruptcy from the court within the same day the information is received by the stock exchange. Any expense arising on such appointment becomes the responsibility of the issuer.

P. Meetings of Debt Securities Holders

The Trustee Contract must set the arrangement of meetings of debt securities holders. The obligations are stated in *Bapepam-LK Rule No. VI.C.4: General Provision and Trustee Contract of Debt Securities*. Under the said rules, the Trustee Contract should include:

1. the purpose of the meetings;
2. the parties who may request the meetings;
3. the procedures to submit request of the meetings;

4. objection to hold meetings, which states that this must be notified in writing including the reasons for refusal to the applicant, with a copy furnished to Bapepam-LK;
5. the announcement, calling, and organization of the meetings;
6. the procedure for the general meeting of holders of debt securities;
7. quorum and decision making;
8. fees and costs incurred to be borne by the issuer;
9. an official report of the meetings that should be notarized;
10. Issuer, trustee, and the holders of debt securities shall comply with the decisions taken in the meetings.

Q. Event of Default

The event of default is a condition when issuers can be defaulting. Bapepam-LK regulation requires that the procedure to declare default be clearly stated in the Trustee Contract. Pursuant to prevailing Bapepam-LK Regulation, the Trustee Contract shall contain a list of events of default that include, among others:

1. The issuer does not pay the principal and interest of the debt securities and sukuk on its maturity;
2. The actual condition about the collateral or the issuer status and its management is different from the information and explanation provided by the issuer;
3. The issuer has been declared in default in relation to a credit agreement by one or more of its creditors (a cross default wherein clauses are used in contracts and grace periods may apply);
4. Suspension of payment (moratorium) of the issuer is declared, and;
5. The issuer does not perform other obligations stated in the Trustee Contract.

Bapepam-LK Rule No. VI.C.4 also requires the Contract of Debt Securities Trustee to contain a clear procedure on solving the event of default or on stating a default. Usually, when an event of default occurs, the trustee would require an issuer to take corrective action to solve the problem during a specific time period. If the issuer does not take the necessary corrective actions, the trustee may invite all bondholders and conduct a general meeting of bondholders to seek clarification from the issuer regarding the failure. If the meeting does not accept the explanation and clarification of the issuer, the meeting may:

1. restructure the debt;
2. declare default status to the issuer; or
3. set another bondholders meeting to decide whether the default will be noticed or not.

More details on the event of default and related laws and regulations may be found in the websites of Bapepam-LK.⁶

⁶ Bapepam-LK. http://www.insolvencyasia.com/relevant_local_legislation/indonesia_bankruptcy_law/index.html; Bapepam-LK. http://www.insolvencyasia.com/insolvency_law_regimes/indonesia/section_i.html; Bapepam-LK. http://www.bapepam.go.id/old/old/e_legal/rules/issuer/XK5.pdf

R. Established Principles and Standards

1. Corporate Governance

The *Company Law of 1995* established the legislative framework for corporate governance in Indonesia. In August 1999, the National Committee for Corporate Governance was created to develop best-practice guidelines and a code of corporate governance.

In order to conduct an orderly, proper and efficient securities trading, the listed company must submit to the exchange a periodical report, incidental report, and conduct a Public Exposé, a general exposé to the public clarifying the performance of the listed company with the purpose of information distribution on its performance. These reports, as set forth in the *IDX Rule No. I-E: Concerning the Obligation of Information Submission*, shall be announced by the exchange at the latest on the next exchange day after the exchange receives the said report. The periodical reports and incidental reports must be submitted by the listed company to the exchange simultaneous to the submission of the said information to the public. The listed company also has to submit a list of officials who are authorized to submit the report to the exchange as stipulated in the same IDX Rule, together with the signature specimen of said officials and its amendment. Other resources on corporate governance in Indonesia are the *Code and Rules on Corporate Governance for Indonesia* and *The Corporate Governance of Listed Companies: A Manual for Investors*.⁷

2. Contracts Law

The statutory basis governing all private transactions is the civil code. An English-language translation of the Indonesian Civil Code and a summary of the relevant contract law can be found in the websites of Suyud Margono & Associates Law Firm and Karimsyah Law Firm.⁸

3. Ethics

The *Capital Market Law (Law 8/1995)* provides the basis for proper market practices in Indonesia. It also identifies violations, including fraud, in buying and selling securities (Art. 90); market manipulation (Art. 91-2); and insider trading (Art. 95-8). Under Art 3.1 of the *Capital Market Law*, Bapepam-LK is responsible for the guidance, regulation, and supervision of the Indonesian capital markets. Bapepam-LK has the authority to license and issue rules for market participants, including rules on codes of conduct. Bapepam-LK rules in relation to ethical market practices, including: (i) *Code of Conduct for Securities Companies Acting as Broker Dealers*, (ii) *Code of Conduct for Securities Companies Acting as Underwriters*, (iii) *Prohibited Investment Advisors Conduct*, and (iv) *Prohibited Investment Manager Conduct* can be found in the Bapepam-LK website.⁹

⁷ Asian Corporate Governance Association. 2008. *Codes and Rules on Corporate Governance for Indonesia*. http://www.acga-asia.org/content.cfm?SITE_CONTENT_TYPE_ID=12&COUNTRY_ID=265; CFA Institute Publication, 2nd Edition. September 2009. *The Corporate Governance of Listed Companies: A Manual for Investors*. Hong Kong, China. <http://www.cfapubs.org/toc/cfb/2009/2009/12>

⁸ Suyud Margono & Associates Law Firm. <http://www.suyud.com/doc/legal-memorandum-document.htm#L002>; Karimsyah Law Firm. <http://www.karimsyah.com/imagescontent/article/20070906170901.pdf>

⁹ Bapepam-LK. 1996. *Code of Conduct for Securities Companies Acting as Broker Dealers*. http://www.bapepam.go.id/old/old/E_Legal/rules/securities/VE1.pdf; Bapepam-LK. 1996. *Code of Conduct for Securities Companies Acting as Underwriters*. http://www.bapepam.go.id/old/old/e_legal/rules/securities/VF1.pdf; Bapepam-LK. 1996. *Prohibited Investment Advisor Conduct*. http://www.bapepam.go.id/old/old/e_legal/rules/securities/VH1.pdf; Bapepam-LK. 1996. *Prohibited Investment Manager Conduct*. http://www.bapepam.go.id/old/old/E_Legal/rules/securities/VG1.pdf

S. Parties Involved in Bond Issuance and Their Respective Roles

1. Issuers

a. Government

The government is the dominant issuer of bonds in Indonesia. The MOF has the authority to issue treasury instruments such as government bonds while BI has the authority to issue SBI. Corporate sector issuers comprise a small percentage of the bond market, representing 16% of total bonds outstanding as of September 2011.¹⁰ According to BAPEPAM-LK Capital Market Statistic, corporate bonds are currently at IDR135 trillion (16%) while government bonds currently amount to IDR696 trillion (84%).

The government is also the principal issuer in the debt market through issuance of Treasury bonds and Treasury bills by the MOF. Government bonds are listed on the IDX, which can be found through IDX's market information on its website¹¹. BI also issues SBIs, which are short-term bank certificates.

To improve market liquidity and provide better access for foreign and local investors, the MOF offered its first ever 3-year retail bonds on 17 July 2006. Government retail bonds are bonds with a required minimum purchase of only IDR5 million, compared with the normal government bond minimum of IDR1 billion. The Government has issued international bonds since 2004. It initially tapped the global market for USD1 billion. Since then, the government is present at least once a year in the international market by issuing global bonds.

b. Corporate Issuers

Corporate issuers have issued either conventional bonds or sukuk. A list of corporate bond and sukuk issuers can be found in the IDX website.¹²

2. Investors

a. General Investors

Domestic financial institutions dominate the debt market. Banks are the major holders of government bonds, with ownership totaling IDR239 trillion as of September 2011, which represents 34% of all government bonds.

b. Asset-Pooling Industries

- i. Pension Funds.** Currently, there are 272 pension fund companies in Indonesia. Two state funds companies dominate the pension fund industry in Indonesia—PT Jamsostek that manages funds for non-government workers and PT Taspen that manages fund for civil servants. As of September 2011, the pension fund industry holds about 5% of all tradable government bonds amounting to IDR35.71 trillion out of IDR696.56 trillion.¹³

¹⁰ Bapepam-LK. 2011. Capital Market Statistics.

¹¹ Indonesia Stock Exchange. <http://www.idx.co.id/Home/MarketInformation/ListOfSecurities/GovernmentSecurities/tabid/106/language/id-ID/Default.aspx>

¹² Indonesia Stock Exchange. <http://www.idx.co.id/Home/MarketInformation/ListOfSecurities/Corporate/tabid/105/language/id-ID/Default.aspx>

¹³ Debt management Office. 2011. <http://www.dmo.or.id/en/content.php?section=86>

- ii. Insurance Companies.** Indonesia's insurance industry is fairly small, but it has been growing steadily since 2000. Currently, there are 141 insurance companies in Indonesia. Insurance companies are important institutional investors in the Indonesian capital market. As of September 2011, the insurance industry holds about 13% of all tradable government bonds, or IDR92.95 trillion out of IDR696.56 trillion.¹⁴
- iii. Mutual Funds.** The managed-fund industry in Indonesia has grown considerably since 2000. Fixed-income assets comprise a considerable portion of investment-fund assets. As of September 2011, the net asset value of mutual funds was valued at IDR154.53 trillion.

3. Intermediaries

a. Banks

According to the *Banking Law* and *Capital Market Law*, banks are allowed to act as an intermediary in government securities trading.

b. Securities Companies

Securities companies in Indonesia may act as broker-dealers, underwriters, and investment managers. However, securities companies should obtain approval from Bapepam-LK for each function before they can offer services to their customers. Currently, there are 146 securities companies in Indonesia.

4. Custodians

A custodian is a person who provides safekeeping services with respect to securities and securities-related assets and other services, including collection of dividends, interest and other entitlements, settlement of securities transactions, and agency services for clients who are account holders. Only a CSD, a securities company, or a commercial bank approved by Bapepam-LK may carry on a business as a custodian. There are currently 20 custodian banks.

There are two CSDs in Indonesia: the Indonesian Central Bank as a CSD for government banks and government sukuk and KSEI as a CSD for corporate bonds and corporate sukuk. One of KSEI's functions as a CSD is distributing corporate bonds and corporate sukuk in the primary market to the investors.

T. Major Players in the Market

Participants in the Indonesian bond market include issuers from the government and the corporate sector; supranational and offshore borrowers; investors comprising financial institutions and asset-pooling industries; intermediaries comprising securities companies, investment houses, and dealers; rating agencies; and market associations. As the largest issuer of bonds, the Government of Indonesia regularly taps the local market to finance the state budget. Corporate bond activities, including conventional and Islamic bond offerings, accelerated significantly beginning in 2003 and have maintained momentum since then. Islamic bonds, which are based on Shari'a principles, play a major role in Indonesian capital markets. In April 2008, the *Islamic Shari'a Debt Bill* was passed into law to enable the government to issue Islamic bonds.

¹⁴ See footnote 13.

II. Primary and Secondary Market Regulatory Frameworks

A. Indonesian Market Regulatory Structure

In general, rules and regulations for the bond market are governed by the Ministry of Finance (MOF). Several regulatory agencies are also involved. Details on the specific functions of these agencies are discussed in this section.

1. Market Entry Requirements

Foreign Investors are free to invest in the Indonesian market. No approval or registration is required for the non-resident investors for investing into Indonesia. Foreign and local investors are treated equally, and the same investment regulations apply to all classes of investors.

2. Market Regulators

a. Ministry of Finance

The MOF is the main body responsible for the administration of finances of the central government and for all economic and financial matters affecting the country.

b. Bank Indonesia

Bank Indonesia (BI) is the central bank of Indonesia. It became an independent central bank with the enactment of *The Central Bank Act* (UU No. 23/1999) on 17 May 1999. The Act confers on it the status and position of an independent state institution without any intervention from the government or any other external parties. BI is fully autonomous and has the authority to formulate and implement regulations as stipulated in the Act. BI is responsible for maintaining the stability of the rupiah, monetary policy, payment system, and regulating and supervising the banking system. It also acts as the central depository for the settlement and safekeeping of government bonds and the Certificate of Bank Indonesia.

c. Bapepam-LK

The Capital Market and Financial Institution Supervisory Agency, locally known as Badan Pengawas Pasar Modal dan Lembaga Keuangan (Bapepam-LK), is a unit of the MOF that regulates and supervises the capital market and non-bank financial services

sector. Bapepam-LK was formed as a result of a merger between the Capital Market Supervisory Agency (Bapepam) and the Directorate General of Financial Institution (DJLK). The merger took place in January 2006. This regulatory body is responsible for regulating all capital market players such as securities companies, investment managers, custodians, and regulating non-bank financial services industry, including insurance, multi-finance, and pension funds. As a regulator, it grants licences to various securities market intermediaries (e.g., brokers, mutual funds, custodian banks, underwriters, etc.) and professionals (accountants, public notaries, lawyers, and appraisers).

Art. 3 of the *MOF Decree No: 503/KMK.01/1997* details the functions of Bapepam-LK. These include:

- i. Prescribing capital market rules and regulations;
- ii. Ensuring compliance toward capital market rules among market players;
- iii. Formulating disclosure requirements for issuers and public companies;
- iv. Guiding and supervising any person granted a business license, approval, and registration from Bapepam-LK, and other persons involved in the capital market;
- v. Settling and re-dressing of disputes of person(s) on whom sanctions have been imposed by the stock exchange, Clearing and Guarantee Corporation or the Central Securities Depository; and
- vi. Establishing capital market accounting standards.

Furthermore, Bapepam-LK has the authority to grant licenses, approvals, and effective registrations to capital market participants.

d. Self-Regulatory Organizations

There are three self-regulatory organizations in Indonesia. These are:

- i. The Indonesia Stock Exchange (IDX)
- ii. The Indonesian Clearing and Guarantee Corporation (KPEI)
- iii. The Indonesian Central Securities Depository (KSEI)

Each regulates its own areas of operations and all regulations issued by the SRO are subject to Bapepam-LK approval.

3. Capital Market Regulations

The key legislation pertaining to the Indonesian capital market is *Law No.8/1995 on the Capital Market*. According to the *Law No. 8/1995* guidance, regulation, and day-to-day supervision of the capital market is to be provided by Bapepam-LK. It is Bapepam-LK's responsibility to ensure an orderly, fair and efficient capital market, as well as protect the interests of the investors and public. The *Capital Market Law* regulates the following:

- a. Bapepam-LK
- b. IDX, KPEI, and KSEI
- c. Mutual funds
- d. Brokerage firms and investment manager companies
- e. Capital market support institutions

- f. Settlement of bourse transaction
- g. Capital market support professions
- h. Issuing and public companies
- i. Reporting and disclosure of information
- j. Fraud and insider trading
- k. Audit
- l. Investigation
- m. Sanctions

A copy of the *Law No. 8/1995* is available in the Bapepam-LK website.¹⁵

4. Regulation on Structured Products

BI enacted a new regulation, *No. 11/26/PBI/2009 on Prudence Banking for Banking Activities Involving Structured Products*. The salient points of the regulation are as follows:

- a. Structured products are defined as commercial bank products that combine two or more non-derivative instruments with derivative instruments, or derivative with derivative instruments with the following characteristics:
 - i. The value or cash flow of the product is tied to one or more underlying variable factors, such as interest rate, exchange rate, commodity rate, and/or equity price.
 - ii. The cash flow's movement does not directly relate to the changes in the underlying variable factors, causing asymmetric payoff. Such arrangement is usually coupled with the features of the product described below:
 - a) Option term i.e., caps, floors, collars, step up or step down, and/or call or put features;
 - b) Leverage;
 - c) Barriers, i.e., knock in or knock out; and
 - d) Binary or digital ranges.
- b. The structured product process is determined as activities and/or the whole process of planning, developing, issuance, marketing, supplying, selling, operating, and/or terminating structured products.
- c. Commercial banks can only start the process on structured products after obtaining approval and statement of effectivity from BI for each structure product.
- d. For a structured product with a combination of two or more derivative instruments, a commercial bank is required to do the following:
 - i. Request their clients to maintain a cash collateral of at least 10% of the total customer's notional value of the transaction. This arrangement has to be reflected in a written contract between the bank and the customer.
 - ii. Exceptions to point (a) above are given to the following customer type:
 - a) Banks,
 - b) The Government of Indonesia,
 - c) Bank Indonesia or other central banks, and

¹⁵ Bapepam-LK. http://www.bapepam.go.id/old/old/E_legal/law/index.htm

- d) Multilateral development organizations or banks.
- e) A commercial bank is required to implement risk management on the structured products process. The risk management policy needs to cover:
 - i. Active supervision of a bank's board of commission and management;
 - ii. Adequate internal policy and procedure;
 - iii. Adequate identification process, measurement, supervision on risk control, and management information on risk; and
 - iv. Internal control system.
- f) A commercial bank is required to classify their customers for structured product activity. Customers can be classified as professional customers, eligible customers, and/or retail customers.
- g) A commercial bank is required to exercise transparency towards customers in each process of marketing, offering, and settlement of structured products.
- h) A commercial bank is required to submit a report on their structured product transactions to BI every month, on the 10th of each month.
- i) Breaches in the terms of this regulation are subject to the sanction imposed by BI including:
 - i. Warning letter;
 - ii. Downgrading of the bank's credibility;
 - iii. Prohibition of the bank clearing activity;
 - iv. Freezing and revocation of effective statement on certain business activities;
 - v. Termination of bank's management; and
 - vi. Inclusion of the bank's management, employees, and shareholders into BI's blacklist.
- j) Transitional rules governing structured products under *No. 11/26/PBI/2009* are as follows:
 - i. Structured products that were issued prior to the issuance of this regulation are still required to obtain an effective letter from BI.
 - ii. Structured products that were issued prior to the issuance of this regulation can be administered until their maturities.

The regulation is effective since 1 July 2009.

5. Asset-Backed Securities

a. Definition of Asset-Backed Securities

An asset-backed security (ABS) in Indonesia is a participating unit of a collective investment contract with a portfolio that consists of financial assets comprising of:

- i. Claims arising from commercial papers,
- ii. Credit card receivables,
- iii. Future receivables,
- iv. Loans including homes or apartment mortgages,
- v. Debt securities guaranteed by the government,
- vi. Credit or cash flow enhancement, and
- vii. Equivalent financial assets and other financial assets related to the aforementioned financial assets.

The collective investment contract of an ABS is an agreement signed by an investment management company and a custodian bank. The contract binds the holder of the participating unit(s) and authorizes the investment management company to manage the collective investment portfolio while the custodian bank provides collective custody services.

b. Types of Asset-Backed Securities

There are two types of ABS—fixed cash flow ABS and variable cash flow ABS. Fixed cash flow ABS are those that give investors certain income similar to those received by debt securities holders. Variable cash flow ABS are those that give the investors uncertain income similar to those received by equity securities holders. Assets for the portfolio of an ABS shall be acquired from true sale transaction that satisfies generally accepted accounting principles. The true sale is from the originator of the ABS Collective Investment Contract. The assets in the portfolio must be supported by an opinion of a legal consultant registered with Bapepam-LK, certifying that the rights of the ABS holders are the same as what has been stated in the ABS Disclosure Document. The originator can only engage in the true sale transaction of assets in the portfolio of an ABS of no more than 10% of the total amount of the assets that have originally been transferred into the ABS by the originator.

c. The Asset-Backed Securities Collective Investment Contract

The ABS Collective Investment Contract may:

- i. Contain different classes or no different classes whatsoever of ABS with different rights;
- ii. Provide the terms under which the ABS of a specified class may be transferred to other Persons;
- iii. Provide for liquidation of the ABS Collective Investment Contract including the disbursement of the financial assets to some or all classes of ABS holders at a specific time or under certain conditions;
- iv. Determine the presence or absence of:
 - 1) insurance for the financial assets in the portfolio for various types of risks, such as credit risks;
 - 2) credit rating of some or all classes of ABS;
 - 3) guarantees from third persons;
 - 4) credit or cash flow enhancements;
 - 5) retention and reinvestment of certain cash flows of the Collective Investment Contract portfolio; and
 - 6) issuance of additional ABS that may be owned by new investors or holders of previously issued ABS.

The contract must include:

- i. The name of the service provider for the financial assets in the Collective Investment Contract portfolio and its responsibilities;
- ii. The name of the securities rating agency if the ABS are to be offered through a public offering
- iii. The name of the registered accountant appointed to audit the financial statements at least once a year;

- iv. The name of the registered legal consultant appointed to provide legal opinion with respect to transfers of financial assets into the Collective Investment Contract portfolio;
- v. A provision regarding the time period of the ABS Collective Investment Contract;
- vi. Provisions regarding any restrictions from selling the ABS back to the investment manager and/or the custodian bank that represents the holders of the ABS;
- vii. Provisions regarding replacement of the investment manager, custodian bank, accountant, servicer provider, rating agency, legal consultant, notary, and other persons involved in the ABS Collective Investment Contract; and
- viii. Remuneration received by persons mentioned above.

It must be notarized by a notary registered with Bapepam-LK.

In the case where the ABS are not offered through public offering, the investment manager is not required to submit a Registration Statement to Bapepam-LK. The investment manager, however, must submit the following documents no later than 10 days after the date of the signing of the Collective Investment Contract:

- i. ABS Disclosure Document;
- ii. Collective Investment Contract; and
- iii. A specimen of the ABS certificate.

As of 3 November 2011, there are four ABS that have been issued with a total securitization of IDR1.95 trillion.

d. Regulations on Asset-Backed Securities

The following are the regulations governing ABS:

- i. *Bapepam-LK Rule No. IX.K.1 on Guidelines for Asset Backed Securities Collective Investment Contracts.*¹⁶
- ii. *Bapepam-LK Rule No. V.G.5 on Investment Manager Functions Relating to Assets Backed Securities.*¹⁷
- iii. *Bapepam-LK Rule No. VI.A.2 concerning Functions of Bank Custodians Related to Asset-Backed Securities.*¹⁸
- iv. *Bapepam-LK rule No. IX.C.10 concerning Guidelines of Form and Content of Prospectus for a Public Offering of Asset-Backed Securities.*¹⁹
- v. *Bapepam-LK Rule No. IX.C.9 concerning Registration Statement for Asset-Backed Securities Public Offering.*²⁰

¹⁶ Bapepam-LK. 1997. *Guidelines for Asset Backed Securities Collective Investment Contracts*. http://www.bapepam.go.id/pasar_modal/regulasi_pm/peraturan_pm/ENG/IX/IXK1.pdf

¹⁷ Bapepam-LK. 1997. *Investment Manager Functions Relating to Assets Backed Securities*. http://www.bapepam.go.id/pasar_modal/regulasi_pm/peraturan_pm/ENG/V/VG5.pdf

¹⁸ Bapepam-LK. 1997. *Functions of Bank Custodians Related to Asset-Backed Securities*. http://www.bapepam.go.id/pasar_modal/regulasi_pm/peraturan_pm/ENG/VI/VIA2.pdf

¹⁹ Bapepam-LK. 1997. *Guidelines of Form and Content of Prospectus for a Public Offering of Asset-Backed Securities*. http://www.bapepam.go.id/pasar_modal/regulasi_pm/peraturan_pm/ENG/IX/IXC10.pdf

²⁰ Bapepam-LK. 1997. *Registration Statement for Asset-Backed Securities Public Offering*. http://www.bapepam.go.id/pasar_modal/regulasi_pm/peraturan_pm/ENG/IX/IXC9.pdf

B. Disclosure Requirements

A prospectus has to cover all details and material facts concerning a public offering done by an issuer that could affect investors' decisions, which are already known or has to be known by the issuer and the underwriter (if any). A prospectus has to be clear and communicative. Facts and considerations that are most important has to be summarized and disclosed at the beginning of the prospectus. The sequence of the facts in the prospectus is determined by their relevance to the facts of a particular problem. The issuer has to be careful when using images, diagrams, or tables in the prospectus, as these materials could give a misleading impression to the public. An issuer must ensure that the disclosure of important information is not obscured by less important information leading to the important information regardless of the reader's attention. Issuers have to make adjustments to the disclosure of material facts with emphasis to their business or industry sector, and the result that a prospectus does not mislead. Issuers, underwriters and capital market support professionals are responsible for determining and disclosing the referred facts in a clear and readable manner.

In a public offering of debt securities, a prospectus contains information regarding:

1. Date of maturity;
2. Interest rates;
3. Interest payment dates;
4. Execution for early redemption;
5. Conversion rights;
6. Warrant;
7. Trustee's full name;
8. Underwriter's full name (if any); and
9. Rating result from a credit rating agency.

In addition, a prospectus must at least disclose the following relevant information:

1. Public offering description;
2. The use of funds obtained from public offering;
3. Statement of indebtedness;
4. Management's discussion and analysis;
5. Risk factors;
6. Important events following the auditor's report date;
7. Information concerning the issuer;
8. Activities and prospects of the issuer;
9. Financial highlights;
10. Equity;
11. Dividend policy;
12. Taxation;
13. Underwriter;
14. Capital-market support professionals;
15. Legal opinion;
16. Financial reports;
17. Appraisal report, if any;
18. Articles of association;
19. Requirements of securities' subscription;

20. Distribution of prospectus and securities' subscription form;
21. Trustees; and
22. Guarantors, if any.

Medium or small companies have to submit a Registration Statement and build a prospectus for public offering based on *Bapepam-LK Rules No. IX.C.7 (Guidelines of Form and Content of Small and Medium Company Public Offer Registration Statement)* and *Bapepam-LK Rule No. IX.C.8 (Guideline of Form and Content of Small and Medium Company Public Offer Prospectus)*.

C. Credit Rating Requirements

Rating requirements for publicly issued debt securities are governed by *Bapepam-LK Rule No. IX.C.11: Rating of Debt Securities* (hereafter referred to as Rule IX.C.11). Issuer who will issue debt securities with maturity period of 1 year or more through a public offering is required to obtain a rating from a credit rating agency (CRA). In order to provide rating services for publicly issued debt securities, a CRA should have a business license from Bapepam-LK. The rating result from the CRA should at least contain information on the strength or weaknesses of the issuer (company rating) and securities issued (securities rating), the strengths or weaknesses related to the ability of the issuer to fulfill the payment obligation or the risk assumed by the securities holders.

Under *Rule IX.C.11*, publicly issued debt securities subject to rating requirements include convertible debt securities or debt securities containing rights to obtain shares.

D. Exemptions for Private Issuance (Private Placement)

A securities offering that does not meet the criteria for public offering (so-called private placement) is exempted from the obligation to submit Registration Statements to Bapepam-LK, and thus exempted from all offering requirements under Bapepam-LK rules.

The criteria for public offering, which is effective within the jurisdiction of Indonesia, or offered to Indonesian citizens through mass media, or offered to more than 100 parties or sold to more than 50 parties in a certain limited amount at a certain time, is covered under Art. 1, No. 1a.15 of the *Elucidation of the Capital Market Law*.

E. Minimum Lead Time for Registration Approval

The Registration Statement becomes effective, either on the basis of elapsed time, which is 45 days since the Registration Statement has been received by Bapepam-LK in complete form, or 45 days since the latest amendments proposed by the issuer or requested by Bapepam-LK have been fulfilled, or on the basis of declaration of effectiveness by Bapepam-LK that no further changes and/or additional information are required.

F. Availability of Shelf Registration and Associated Documentation Requirements

To facilitate debt securities and/or sukuk public offering, Bapepam-LK has issued *Rule No. IX.A.15 : Continuing Public Offering* (commonly known as Shelf Registration). To do debt securities and/or sukuk public offering under the shelf-registration scheme, both the issuer and the securities offered have to meet certain criteria, as stipulated by *Rule IX.A.15*.

In order to do debt securities and/or sukuk public offering under the shelf-registration scheme, the issuer is required to submit a Registration Statement in accordance with *Rule IX.A.1*, *Rule IX.A.2*, *Rule IX.C.1*, and *Rule IX.C.2* (unless otherwise stated in *Rule IX.A.15*), along with a Statement Letter from the issuer and accountant that the issuer has never been in the event of default during period of time as regulated in *Rule IX.A.15*. Under shelf-registration scheme, the issuer is required to:

1. For any subsequent stages of offering, submit additional information and supporting documents to Bapepam-LK, and publish it in one Indonesian daily and nationally circulated newspaper, at least 7 working days before the offering period starts.
2. For every stage of offering, submit a report on the result of public offering at least 5 working days following the allotment date;
3. In case the amount of funds raised during the 2-year period of shelf registration is below target, submit to Bapepam-LK and publish in one Indonesian daily and nationally circulated newspaper the total amount of raised funds and the reasons for not achieving the target, at least 5 working day following the allotment date of the last stage.

G. Regulated Suspension Period

Under *Rule IX.A.2*, within the period from the effective date of the Registration Statement to the end of a public offering period, the issuer may postpone the offering period for a maximum of 3 months since the effectivity date, or cancel the public offering, if the following uncontrollable events take place:

1. The composite index of the stock exchange drops by more than 10% within 3 consecutive exchange days.
2. Natural disaster, war, riot, fire, and strike that significantly impact the issuer's concern.
3. Other events stipulated by Bapepam-LK as having significant impact on the issuer's concern.

For postponement or cancellation of public offering, the issuer must fulfill the following requirements:

1. Publish the information of postponement or cancellation in at least one Indonesian daily and nationally circulated newspaper, no later than 1 working day after the postponement or cancellation. In addition to the obligation to publish the postponement or cancellation information in a newspaper, the issuer

- may also publish the information through other mass media.
2. Submit the information of postponement or cancellation to Bapepam-LK on the same day of the publication.
 3. Submit the proof of publication to Bapepam-LK no later than 1 working day following the publication.
 4. If the subscription money has been received, the issuer must return the money to the subscribers no later than 2 working days since the decision of postponement or cancellation is made.

To resume the postponed offering period, the issuer must fulfill the following requirements:

1. In case the postponement is caused by a decrease in the stock exchange composite index, the issuer must resume the offering period no later than 8 working days after the composite index increases by at least 50% of the total decrease on which the postponement is based.
2. If the composite index of the stock exchange drops, the issuer may arrange for another postponement.
3. Submit to Bapepam-LK information regarding the offering schedule and other additional information, including material events occurring after the postponement (if any) and publish it in at least one Indonesian daily and nationally circulated newspaper, no later than 1 working day before the offering period resumes.
4. Submit a proof of publication to Bapepam-LK no later than 1 working day following the publication.

H. Other Requirements

Public offering of debt securities denominated in currency other than rupiah must comply with all regulations related to public offering. In addition, under Rule IX.A.11 on public offering of debt securities denominated in currency other than rupiah, the following information must be disclosed in the prospectus:

1. The amount and maturity period of non-rupiah-denominated debt securities, and its rupiah equivalent at the time when the securities are offered.
2. The currency risk and its impact on the issuer's financial condition.
3. The potential cost and benefit associated with that facility, if hedging facility is applied.
4. If the sinking fund for repayment is applied, the requirements for the sinking fund.
5. Whether the issuer's asset is pledged as collateral of the debt securities.
6. The issuer's revenue earned in rupiah and in other currencies.

As stated in Rule IX.A.11, the underwriter or issuer (in case there is no underwriter) is required to submit a report on the amount and maturity date of the interest and principal payment within 5 working days following the allotment date of non-rupiah-denominated debt securities.

I. Rules and Requirements on Continuous Disclosure

According to Bapepam-LK rules, the issuer is required to submit periodic or non-periodic reports such as quarterly report on use of proceeds, annual report, annual financial statement and semiannual financial statement, and report on material facts. Submission follows the public offering of debt securities. This obligation prevails as long as the securities are still outstanding. If the Issuer of debt securities also conducts public offering of shares securities, the issuer is also subject to other disclosure requirements under the following Bapepam-LK rules:

1. *No. X.K.1* regarding disclosure of information that must be made public immediately;
2. *No. X.K.2* regarding obligation to submit periodic financial statements;
3. *No. X.K.4* regarding reports on the use of funds received from a public offering; and
4. *No. X.K.6* regarding the obligation of the issuer and the public company to submit an annual report.

J. Restrictions for Investors

Investment policy guidelines for investors of insurance and pension funds are being developed by the authorities to manage risk.

K. Definition of Qualified Institutional Investors and Professional Investors

There are no definitions pertaining to qualified institutional investors and professional investors in Indonesia.

L. Requirements and/or Restrictions for Non-Residents

There are no requirements and/or restriction for non-resident investors in Indonesia.

M. Finding a Fair Price

The difficulty in calculating prices that reflect fair values is more likely aggravated by the condition of the relatively illiquid and over-the-counter (OTC) nature of the debt-securities and sukuk market. Unlike the equity market, which is fairly liquid in terms of frequency, only a small portion of debt securities and sukuk tradable in the secondary markets are traded daily and has daily price information. This condition renders the need for daily fair market price valuations as extremely vital for market players and investors in managing their investments and portfolio risks. To ensure market functions for finding fair market price for debt securities and sukuk, Bapepam-LK has established a regulation concerning securities-trade reporting and securities pricing agencies. *Bapepam-LK Rule No. X.M.3* concerning bond transaction reporting aims to enhance the development and integrity of the debt-securities and sukuk

market via the reporting of securities trading. All transactions on debt securities and sukuk that have been sold through public offering, government securities and other securities (as determined by the chairman of Bapepam-LK), which are traded in the secondary market, have to be reported to Bapepam-LK within 30 minutes. Reporting is done via trade repository or reporting system operated by the IDX on Bapepam-LK's behalf. In the reporting procedures under exchange rules concerning reporting of securities trading through the Centralized Trading Platform Beneficiary of Securities Transaction Report (CTP-PLTE), participants who report via CTP-PLTE should enter data including the price of securities trading. Furthermore, with the release of *Bapepam-LK Rule No. V.C.3* concerning securities pricing agency, which was passed in 2007, a new market infrastructure (securities pricing agency) was introduced to the market. In response to the rules No. V.C.3, PT Penilai Harga Efek Indonesia, or the Indonesian Bond Pricing Agency (IBPA), was established in 2007 and earned the license as a securities pricing agency from Bapepam-LK on 10 August 2009. As a securities pricing agency, IBPA is responsible for establishing daily fair market prices of government and corporate debt securities and sukuk, which all market participants can obtain.

N. Taxation Framework and Tax Requirements

1. General Framework

Taxation arrangements are divided for Surat Perbendaharaan Negara (SPN) and bonds (both government and corporate). *Government Regulation (PP) No. 27/2008 on Income Tax on Discounted Government Treasury Bills* and *PMK No. 63/PMK.03/2008* on the procedure for withholding income tax on discounted SPN regulate the collection of income tax which is final. The amount of income tax is determined as:

- a. 20% for the local taxpayers and fixed business form, and
- b. 20% or based on tariff provisions under the *Double Taxation Treaty* (or P3B in Indonesian) for taxpayers resident or those domiciled abroad.

PP No. 16/2009 regulates taxation provisions of capital gains and interest of debt securities. The income received and/or obtained by the taxpayer in the form of interest of debt securities is subject to withholding of income tax which is final and the amount is determined as follows:

- a. Interest of debt securities with coupon:
 - 1) 15% for local taxpayers and fixed business form; and
 - 2) 20%, or in accordance with the tariff on avoidance of double taxation agreement for foreign taxpayers apart from the fixed business form and from the gross amount of interest in accordance with the period of bond ownership.
- b. Discount of debt securities with coupon:
 - 1) 15% for local taxpayers and fixed business form; and
 - 2) 20%, or in accordance with the tariff on avoidance of double taxation agreement for foreign taxpayers apart from fixed business form

and from the excess of selling price or nominal value over the price of the bond's acquisition, not including current interest.

- c. Discount of no interest debt securities:
 - 1) 15% for local taxpayers and fixed business form; and
 - 2) 20%, or in accordance with the tariff on avoidance of double taxation agreement for foreign taxpayers apart from fixed business form and from the excess of selling price or nominal value over the price of the bond's acquisition, not including current interest; and
- d. Interest and/or discount of debt securities received and/or obtained by the taxpayer of mutual funds listed on Bapepam and LK:
 - 1) 0% for 2009 until 2010;
 - 2) 5% for 2011 until 2013; and
 - 3) 15% for 2014 onwards.

Corporate and government bonds, or other government bonds under one year which are reported to be traded on the stock exchange, are stipulated under *Government Regulation No. 6 of 2002* regarding income tax on interest and discount on bonds traded and/or reported as traded on the stock exchange. The amount of income tax is prescribed as follows:

- a. For interest-bearing bonds:
 - 1) 20% for local taxpayers and fixed business form;
 - 2) 20%, or in accordance with the tariff on the avoidance of double taxation agreement, for bagi for taxpayer resident and/or those domiciled abroad from the gross amount of interest based on the holding period of the bond.
- b. For bond discount with coupon:
 - 1) 20% for local taxpayer and fixed business form;
 - 2) 20%, or in accordance with the tariff on P3B, for taxpayer resident and/or those domiciled abroad, from excess from the nominal value of the selling price over the price of the bond's acquisition, not including the current interest (or accrued interest).
- c. For zero-coupon bond:
 - 1) 20%, for local taxpayers and fixed business form;
 - 2) 20%, or in accordance with the tariff on P3B, for bagi for taxpayer resident and/or those domiciled abroad, from excess from the nominal value of the selling price over the price of the bond's acquisition.

Under the *Decision of the Director General of Taxation (KDJP) No. PEM-241/PJ./2002* dated 16 May 2002, in conjunction with *KDJP No. KEP-241/PJ./2002* dated 30 April 2002, on procedures for the implementation of income tax withheld on interest and discount bonds traded and/or reported as traded on the stock exchange, the cuts on income tax are also carried out by an issuer or a custodian designated as the payment agent for:

- 1) Interest received or obtained by bondholder with coupon at the time of the interest's maturity date; and
- 2) Discount received or obtained by bondholder with coupon and no interest bond at the time of the bond's maturity date;

Recipients of the income tax cut have to report the cut and the deposit of income tax to the Tax Office no later than the 20th day of the next month following the Notice of Income Tax Period.

The first-in-first-out (FIFO) principle in taxation of capital gains tax (CGT) is applied on trade-by-trade basis. For trades, however, the client can trade-allocate, if so desired.

2. Procedures for Tax Collection

The Tax Office has the mission to collect taxes for the government. KSEI already has the feature to calculate the CGT for transactions, and, thus, BI may not need to provide such functionality.

Traders tend to use favorably the avoidance of double taxation agreements (DTA) domiciles. The custodian withholds tax but the client calculates and instructs the corresponding tax amount. Selling bonds attracts CGT, thus, the seller's agent calculates the corresponding tax while the buyer's agent withholds the tax and makes the payment to the tax authorities. As a result, buyer and the seller will need to amend the original instructions after calculation of the tax impact.

The documentation required to prove the applicable tax rate is complex using two main documents: Certificate of Residence (COR) or Certificate of Domicile (COD) and a certificate from the issuer. The CIR or the COD is to be renewed annually, while the issuer's certificate is valid only for 1 month. Computation of the withholding of tax is strictly on basis of the supporting documents received.

The following box illustrates the practical considerations for the withholding tax procedure using the example of a Singapore domiciled entity.

Box 2.1 Application of Indonesia's Avoidance of Double Taxation Agreements

Application of Indonesia's DTAs

Indonesia has recently enacted regulations concerning the application of its DTAs to a non-Indonesian resident recipient ("Recipient") of income paid by an Indonesian payer. These regulations are effective beginning 1 January 2010 and provide that if a Recipient intends to claim withholding tax benefits under a relevant DTA, it must submit a timely application for a certificate of domicile ("CoD"). This CoD uses a standard form issued by the Indonesian tax authority which can either be found in Forms DGT 1 or DGT 2, depending on the circumstances of the Recipient. The CoD form must be filled out and signed by the Recipient, and is to be certified by the foreign competent authority where the Recipient is a tax resident. The Indonesian payer will then submit the CoD form together with its monthly tax return to the Tax Office before the end of the monthly tax reporting period (i.e., 20th of the following month).

Form DGT 1 that applies to non-banks is valid for up to 12 months if (i) the Recipient receives the income from the same Indonesian payer; and (ii) the name and address of the Recipient remain the same during the 12-month period. Form DGT 2, which applies for banks, is also valid for a 12-month period and can be copied or reused by different Indonesian payers but the copy must be validated by the head of the local tax office where the first Indonesian payer is registered.

The Recipient should note that the CoD form is to be submitted before each payment is made by an Indonesian payer, failing to do so will result to not being able to avail of the treaty benefits. If the Recipient is only able to provide the CoD form after the monthly tax reporting period is over and the withholding tax has been applied at the general rate in accordance with the applicable Indonesian *Income Tax Law* (i.e., 20%), the Recipient is still able to apply for a tax refund. The refund mechanism likely follows the existing tax refund mechanism, in which the application will be submitted to the local tax office where the Indonesian payer is registered.

continued on next page

Box 2.1 continuation

Since Singapore is one of Indonesia's DTA partners, the new regulations would affect a Singapore tax-resident Recipient in the following ways, as provided by the Inland Revenue Authority of Singapore (IRAS):

When an Indonesian payer makes a payment to a Singapore tax-resident Recipient and Indonesian withholding tax is due on the payment, the Singapore tax-resident Recipient cannot claim the Singapore-Indonesia treaty benefits on the payment unless IRAS certifies the CoD form that has been filled out and the signed 2 Tax Client Alert February 2010 by the Singapore tax-resident Recipient, and the CoD form is submitted to the Indonesian tax authority before the payment is made. IRAS has since issued an informal clarification on this CoD certification procedure. When the Singapore tax-resident Recipient applies with IRAS for certification of the CoD, IRAS is only expected to provide certification on the residence status of the Singapore tax-resident Recipient. In other words, IRAS will provide certification of the CoD if the Singapore tax-resident Recipient satisfies the requirements of Art. 4(1) of the Singapore-Indonesia DTA (i.e., for non-individual persons, management and control have to be in Singapore). The certification process by IRAS is expected to take about 2 weeks to a month from the date of receipt of the duly completed CoD.^{a, b}

Notes:

^a Inland Revenue Authority of Singapore. <http://www.iras.gov.sg/irasHome/page.aspx?id=812>

^b Baker and Mckenzie. <http://www.bakermckenzie.com/RRIndonesiaRegulationsAvoidanceDoubleTaxationMay10/>

DTA = Double Taxation Agreement; CoD = Certificate of Domicile; DGT = Directorate General of Taxes; IRAS = Inland Revenue Authority of Singapore

Source: Baker and Mckenzie. 2010. Recent Changes in Tax Law—Indonesian Regulations on Avoidance of Double Taxation.

O. Other Regulatory Reporting Requirements

1. Reporting Requirements

Direct deals between issuers and investors should be included in the reporting obligation Regulation No. X.M.3, although it is not specifically stated. The reporting obligation is applicable to any kind of bond transaction.

2. Outbound Investment

Mutual funds may only invest up to 15% (conventional mutual fund [MF]) or 30% (capital-protected MF) of NAV in overseas investments, particularly in assets 'on an exchange or market with information accessible through the mass media in Indonesia or the Internet'. Restrictions are found in both Bapepam-LK regulations and guidelines, and the mutual fund's specific constituting documents.

Regulation prohibits pension funds to invest in overseas instruments while insurance companies have to follow prudential regulations. Other investors include mutual funds, pension funds, foreign financial institutions, insurance companies, and individuals. A breakdown of government bond ownership is detailed in the "Capital Market and Non Bank Financial Industry Master Plan 2010-2014."²¹

3. Non-Rupiah Bonds Issuances

Non-rupiah bonds issuances are permitted in Indonesia. Non-government issuance requirements and processes are governed by *Bapepam-LK Rule No. IX.A.11: Public Offering of Debt Securities Denominated in Currency Other than Rupiah*.

²¹ Bapepam_LK. 2010. *The Capital Market and Non Bank Financial Industry Master Plan 2010–2014*. <City of Publication (if available): Country of Publication>. http://www.bapepam.go.id/pasar_modal/publikasi_pm/info_pm/MASTERPLAN_BAPEPAMLK_2010-2014_ENG.pdf?bcsi_scan_7823DFCE46415F3E=0&bcsi_scan_filename=MASTERPLAN_BAPEPAMLK_2010-2014_ENG.pdf

P. Challenges and Expected Changes—Policy Initiatives and Reforms

1. Indonesia Capital Market Plan

The Capital Market and Financial Institution Supervisory Board (Bapepam-LK) operates on a 5-year capital market plan. The most recent plan (2010–2014) outlines specific development strategies for various market participants and a general strategy for the capital market and non-bank financial industry. Proposed reforms are also included in the “Capital Market Plan.” The “Bapepam-LK Master Plan 2010–2014” has five objectives:

- a. To generate an easily accessible, efficient and competitive source of funds.
- b. To create a conducive and attractive investment climate, as well as reliable risk management.
- c. To develop a stable, resilient and liquid industry.
- d. To implement a fair and transparent regulatory framework which guarantees legal certainty.
- e. To develop a credible and reliable international standard infrastructure.

2. Indonesian Banking Architecture

The Indonesian Banking Architecture establishes the banking system’s direction, outline, and working structures for a 5- to 10-year period in support of a strong, stable, and efficient banking system that promotes national economic growth.²² It comprises the following sections:

- a. Six Pillars of Indonesian Banking Architecture;
- b. Challenges Ahead;
- c. Action Plan; and
- d. Phases of Implementation.

3. Blueprint for the Development of Islamic Banking and the Development of the Shari’a Capital Market

BI maintains a 10-year blueprint for the development of Islamic banking. The blueprint formalizes Indonesia’s strategic bid to strengthen Islamic banking institutions with respect to Shari’a compliance, regulatory structures, operational efficiency, and systemic stability. This effort is regarded as an important step towards building Indonesia’s Islamic capital markets.²³

Bapepam-LK develops the Shari’a capital market based on the “Capital Market and Non-Bank Financial Industry Master Plan 2010–2014.” As discussed in the Master Plan, the Shari’a capital market will be developed through four main programs, namely developing a regulatory framework that supports the development of the Shari’a capital market; developing Shari’a capital market products; promoting equality between Shari’a-based financial products and conventional financial products; and enhancing the development of human resources in the Shari’a capital market.

²² Bank Indonesia. 2004. *Indonesian Banking Architecture*. Indonesia. <http://www.bi.go.id/web/en/Perbankan/Arsitektur+Perbankan+Indonesia/>

²³ Bank Indonesia. 2002. *Blueprint of Islamic Banking Development in Indonesia*. Indonesia. <http://www.bi.go.id/web/en/Publikasi/Perbankan+dan+Stabilitas+Keuangan/Laporan+Perbankan+Syariah/blueprint.htm>

III. Trading and Trading Market Infrastructure of Debt Securities

Figure 3.1 below illustrates the market infrastructure of debt securities in Indonesia.

Figure 3.1 Market Infrastructure of Debt Securities in Indonesia

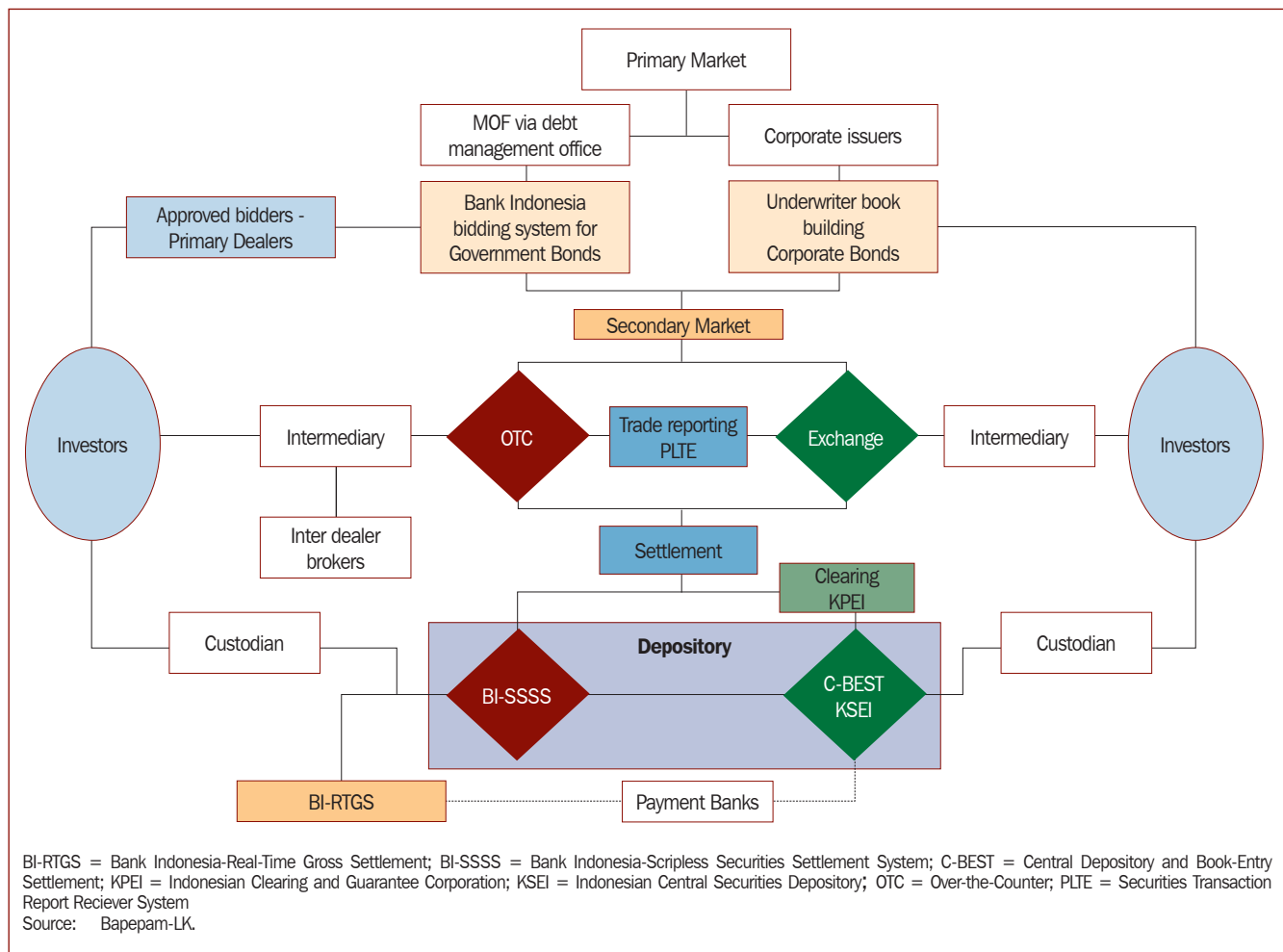

A. Trading and Reporting Platforms

Debt securities trading and reporting platforms in Indonesia are:

1. Exchange Platform

Debt securities and sukuk that can be transacted through the exchange platform are those listed on the IDX using trading facilities provided by IDX called Fixed-Income Trading System (FITS). The bonds and sukuk trading mechanism through the FITS is integrated with the systems for clearing and settlement. There are three different mechanisms, as illustrated in Figure 2.1, such as trading, clearing, and settlement.

2. Over-the-Counter Platform

In OTC transactions, there are a large number of market participants broader traders and transactions are entered into through a negotiation mechanism. OTC transactions are done in various platforms such as voice box, chatting, or instant messenger. Settlement of government securities is done through a sub-registry designated by BI on Bank Indonesia-Scripless Securities Settlement System (BI-SSSS), whereas settlement for OTC transactions on corporate bonds is done by Indonesian Central Securities Depository (KSEI) using its system, Central Depository and Book-Entry Settlement (C-BEST).

3. The Ministry of Finance Dealing System

The MOF, through its Debt Management Office (DJPU), may buyback government bonds in the secondary market. It can be done through buyback auction using the Ministry of Finance Dealing System (MOFIDS) or through direct transaction via the MOF dealing room. Each buyback scheme has a different finance minister regulation as legal basis. Direct transaction is based on *Finance Minister Regulation No. 170/PMK.08/2008* regarding government debt securities direct transaction, while buyback including debt switch auction is based on *Finance Minister Regulation No. 209/PMK.08/2009*.

4. Centralized Trading Platform

The Centralized Trading Platform (CTP)-Reporting System is a system developed by IDX as a Beneficiary of Bond Transaction Report (PLTE) to facilitate the reporting obligations of participants of their bond transactions, as prescribed by *Bapepam-LK Rule No. X.M.3* regarding bond transaction reporting. IDX was appointed by Bapepam-LK as a PLTE by virtue of *Chairman of Bapepam-LK Decision No. KEP-338/BL/2009* dated 30 September 2009. Reporting through the PLTE is done electronically using CTP.

5. Bank Indonesia-Scripless Securities Settlement System

In the domestic primary market, BI is appointed as the auction agent for government securities. Government securities auctions are conducted based on calendar issuance and facilitated by the Bank Indonesia-Scripless Securities Settlement System (BI-SSSS). BI-SSSS is designed to provide a system for government securities settlement. It facilitates online settlement transactions between the sub-registries. Meanwhile, cash settlement of government securities still relies on Bank Indonesia-Real Time Gross Settlement (BI-RTGS).

B. Debt Securities Trading on Exchange

Scripless debt securities and sukuk listed on the stock exchange may be traded on regular and negotiations market. On a regular market, trading of debt securities and sukuk is conducted among exchange members through continuous offers based on price and time priority on FITS. Before matching, an exchange member may amend or withdraw the offer which has already been sent through FITS. Trading of debt securities and sukuk on the negotiations market occur based on deals between two exchange members or one exchange member to fulfill the needs of different clients and/or to fulfill its own needs. Below are the IDX rules on debt securities trading:

1. *No. II.F* regarding General Provisions of Debt Securities Trading in the Stock Exchange.
2. *No. II.F.1* regarding Procedures for Trading of Debt Securities.
3. *No. II.F.3* regarding Clearing, Settlement and Guarantee of Debt Securities.
4. *No. III.C* regarding Exchange Membership to Trade Debt Securities, Sukuk, and Asset Backed Securities with Fixed Cash Flow.

C. Over-the-Counter Trading of Debt Securities

In OTC transactions, there are a large number of market participants and transactions are entered into through a negotiation mechanism. Trading platform or searching functions vary from manual by phone, voice box or through a chatting platform. Settlement of government securities is done via sub registry designated sub-registry, while the settlement of transactions on corporate bonds, or any exchange transaction (either corporate or government bond), is done through KSEI's C-BEST.

D. Bond Repurchase Market

Indonesia launched a repo market in 2004 and the Master Repurchase Agreement (MRA) in 2005. The MRA is the benchmark for repurchase transactions, which are set in HIMDASUN rule as a market operator for government bond trading. Bapepam-LK has not specifically regulated the bond repurchase market yet; however, it already accommodated accounting treatment for issuers and/or securities companies who trade government bond repo and reverse repo using MRA.

In 2010, Bapepam-LK, BI, and DJPU took the lead on introducing policy initiatives of creating a Global Market Repurchase Agreement (GMRA) Indonesian Annexes and act as facilitators for market players in developing the GMRA Indonesian Annexes. A standardized agreement in the form of GMRA Indonesian Annexes is expected to encourage the development of repo transaction among all market participants. Market participants involved in this project are HIMDASUN, IDX, KPEI, KSEI, Indonesia Securities Company Association, Custodian Bank Association, and other related associations in the market. *Bapepam-LK Rule No. VIII.G.13: Accounting Treatment for Repurchase Agreement (REPO) Using Master Repurchase Agreement (MRA)* governs the bond repo market.

E. Debt Securities and Sukuk Trading Mechanism

Figure 3.2 The Indonesian Fixed-Income Market

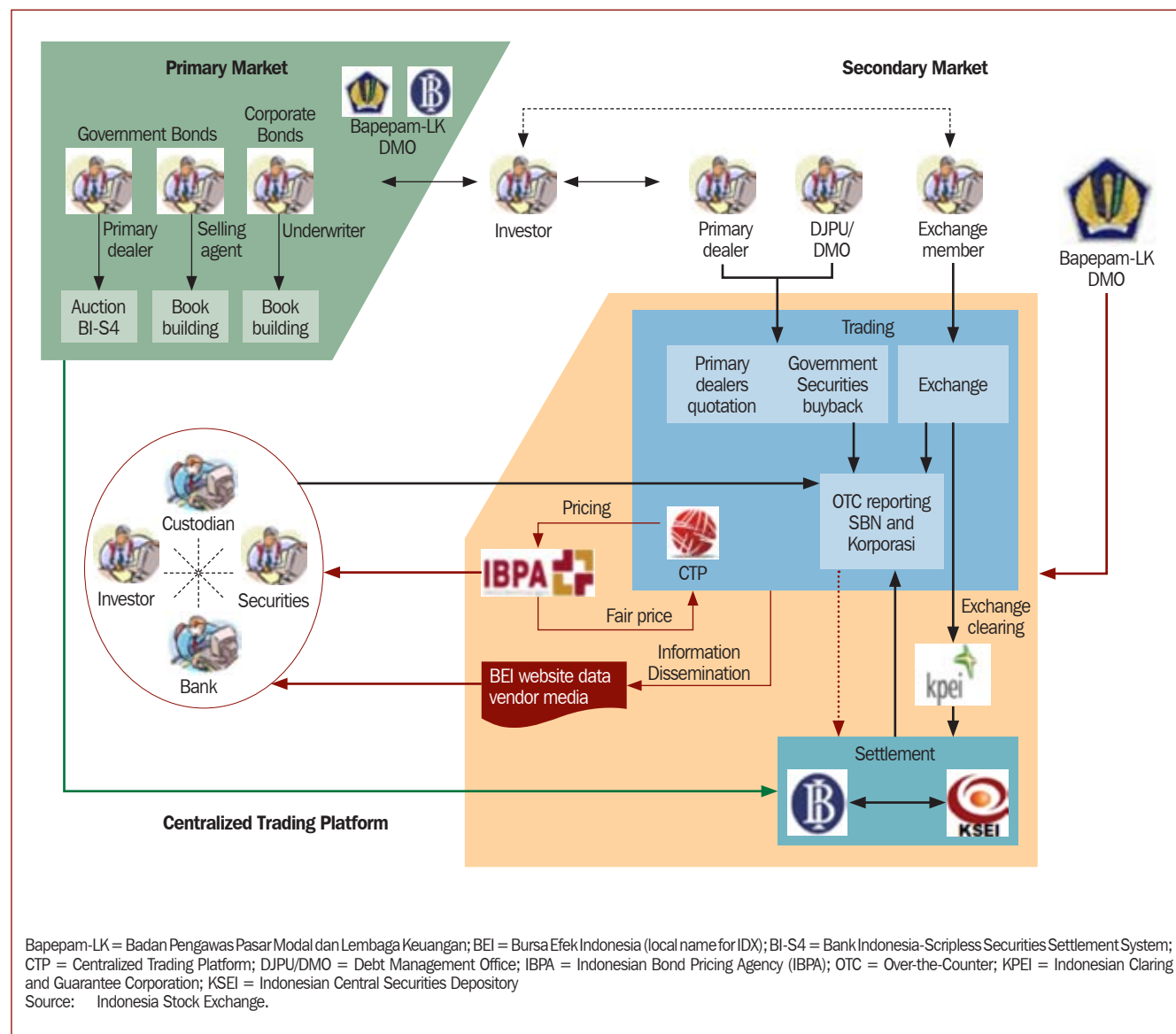

The main activity in the primary market for government securities are auctions using the BI-S4SS conducted by primary dealers appointed by the Indonesia MOF Debt Management Office (DMO). Bookbuilding of ORI and retail sukuk is done in the primary market by a selling agent also appointed by the DMO. IDX will list government securities after receiving an Auction Result Announcement from DMO. Once listed on the exchange, all systems supplied by IDX such as the Trading System, the Transaction Reporting System and the Government Securities Repurchase Auction System will make adjustments to the data, before it is ready to be used for trading and reporting.

The secondary market for debt securities and sukuk can be done through IDX and OTC. For exchange transactions, trading is done by members of the stock exchange using FITS. Clearing and guarantee are executed by KPEI while settlement of transactions is carried out by KSEI. For OTC transactions, trading is done by a much wider range of players, typically using negotiating mechanism. Settlement of government securities transactions is conducted through the sub-registry appointed by the Bank Indonesia, while corporate bond transactions are done through KSEI. Each party (securities companies, banks and custodian banks) has an obligation to report all debt securities transactions through the Centralized Trading Platform (CTP) reporting system.

1. Exchange Platform

FITS is the bonds and sukuk trading facility for debt securities and sukuk that can be transacted through exchange platform and are listed on the IDX. Users of this system are securities companies that are exchange members and KPEI clearing members. Debt securities and sukuk trading through FITS is an integrated trading system with clearing and settlement, and like equity transactions, settlements are done on T+2. Debt securities and sukuk trading activities through FITS is supported by IDX trading regulations with the approval of Bapepam-LK. One of the clauses regulate the unit of trading (lot size), where one lot is equal to IDR5 million, which is based on a framework of equity investors so investors can own bonds or sukuk issued either by a national private company or the government.

FITS uses remote access from exchange members' offices, so exchange members can give a service order (buy or sell) to its clients effectively and efficiently. The system also allows members to do debt securities and sukuk transactions in the two trading boards of IDX—the regular outright market and the negotiated market. The regular outright market is the trading mechanism wherein anonymous continuous bids and offers forms the market price, and the trading method is based on price and time priority. The negotiated market, on the other hand, is the facility that allows an exchange member to report the results of its negotiation with other exchange members or other parties.

2. Government Securities Buyback Mechanism

The MOF through the DJPU/DMO may buyback government bonds in the secondary market through buyback auction using MOFIDS or direct transaction via the MOF dealing room. Each buyback scheme has different finance minister regulation as its legal basis. So far the government conducts buyback operation of government bonds in the secondary market limited to primary dealers either facilitated by MOFIDS or through a chatting machine from the MOF dealing room. Primary dealers' obligation to provide continuous two-way price quotations (bid and offer prices) for benchmark series is facilitated through the primary dealers' quotation system infrastructure that is already integrated with the CTP. This quotation obligation results in promoting government bonds trading in the secondary market. In fact, government bonds are mostly traded over the counter even though they can be traded through the exchange mechanism.

3. Centralized Trading Platform

For the purpose of reporting securities transactions through the trade repository using the IDX system (or PLTE), IDX has developed a system that can facilitate users' trading and reporting transactions called CTP. The CTP feature facilitates debt securities reporting, information, and government bond's quotation for benchmark series. To use the CTP, the participant shall appoint authorized personnel to operate it. IDX will provide a user identification and password to the authorized personnel after undergoing CTP training by the stock exchange.

Reporting of securities transactions is conducted by the participant with the seller as an initiator and then confirmed by the buyer no later than 30 minutes after the transaction. Participants, in this respect, refer to securities companies, commercial banks, and custodian banks, among others. Reporting data from these participants will then be consolidated with the transaction settlement data from BI and KSEI. The purpose of such consolidation is to determine which transactions have been settled through BI and KSEI but are not reported to the PLTE.

4. General Over-the-Counter Process Flow

Although it is typically regulated, OTC trading usually done in the manner shown in Figure 3.3.

Figure 3.3 Over-the-Counter Process Flow

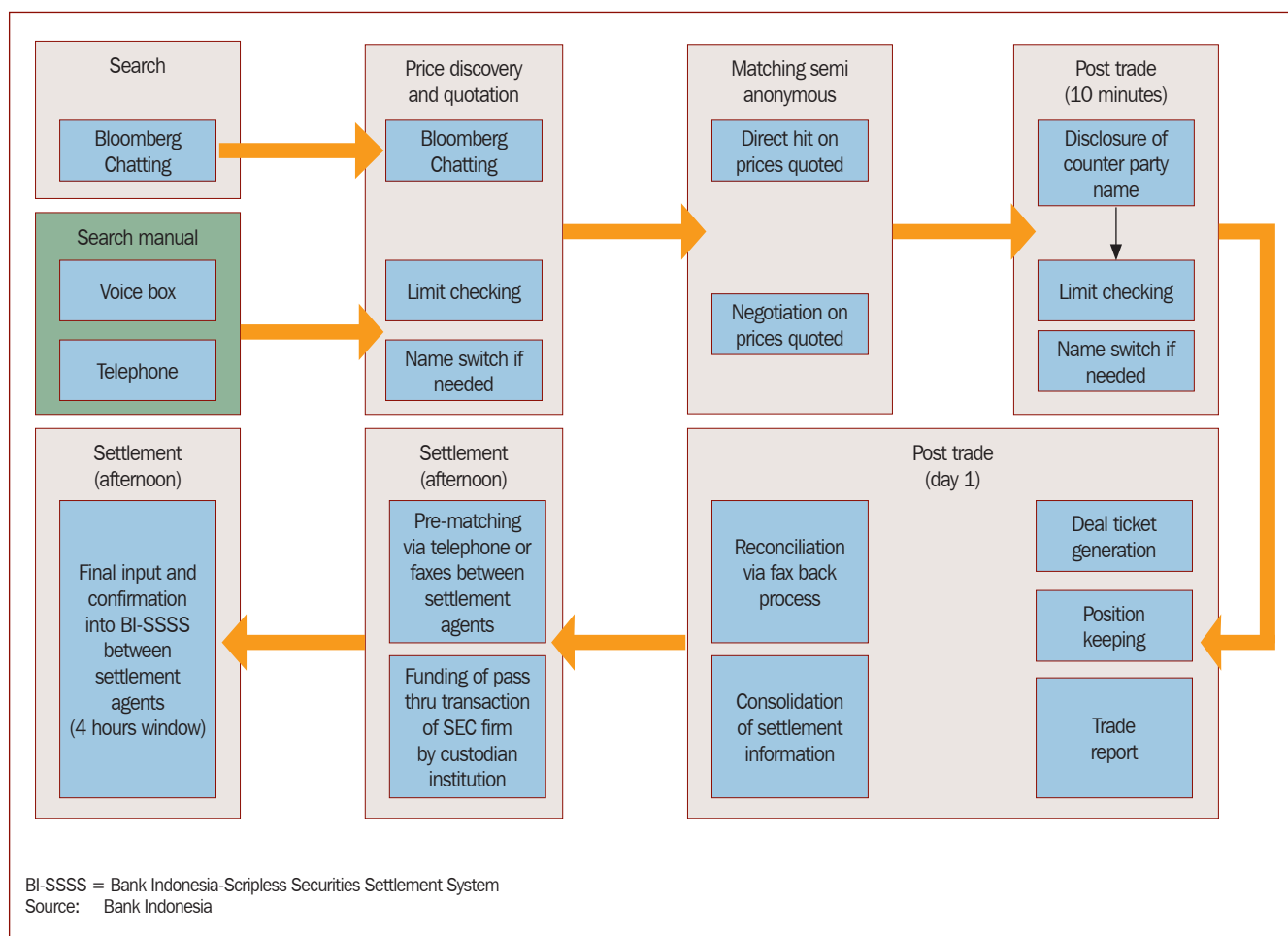

5. Transparency in Bond Pricing

All transactions of debt securities and sukuk that have been sold through public offering, government securities and other securities (determined by the chairman of Bapepam-LK), which are traded in the secondary market have to be reported to Bapepam-LK within 30 minutes. Reporting is done via trade repository or through the reporting system, PLTE, operated by IDX on behalf of Bapepam-LK. Securities transactions that must be reported are:

- a. Buying and selling (outright);
- b. Grants;
- c. Heritage;
- d. Exchange;
- e. Transfer due to court order;
- f. Ownership transfer because of merger, consolidation, or acquisition;
- g. Lending and borrowing;
- h. Repurchase agreement or repo;
- i. Book-entry securities made by the parties with the same identity; and
- j. Buy back.

The information that must be reported includes:

- a. Name and series of securities;
- b. Name of seller or original owner;
- c. Name of buyer;
- d. Type of account (own account or client accounts);
- e. Price of the transaction;
- f. Yield;
- g. Volume of transaction;
- h. Value of the transaction;
- i. Time of the transaction;
- j. Reporting time or instruction time to the participant;
- k. Type of transaction; and
- l. Settlement date, among others.

The information on name and series of securities, price, volume, yield, value, settlement date, type of transaction, and repo rate or period must be disseminated by the trade repository real time to the public. This information is used as data source by the securities pricing agency in determining reference prices of debt securities and sukuk. Securities transaction reporting is governed by *Bapepam-LK Rule No. X.M.3*.

F. Pricing Platforms

The IBPA was established on 28 December 2007 in response to the issuance of *Bapepam-LK Rules No. V.C.3* concerning securities pricing agency. IBPA earned its formal license as a securities pricing agency from Bapepam-LK on 10 August 2009. As a securities pricing agency, it is responsible for establishing the daily fair market prices of government and corporate debt securities and sukuk. The establishment of the securities pricing agency improves market transparency and ensures a fair trading

environment in the debt securities and sukuk market. With the creation of a securities pricing agency, all market participants are given equal access to fair market prices information to aid investment decisions. In the process of valuing and determining debt securities and sukuk fair market prices, IBPA uses a consistent and transparent valuation and pricing methodology, and utilizes objective and reliable market data information, as well as the latest market condition. More information can be found on the IBPA website.²⁴

²⁴ Indonesian Bond Pricing Agency. www.ibpa.co.id

IV. Possible Impediments and Restrictions

A. Taxation

Presidential Decree No. 16/2009 on Income Tax on Interest Bonds Income regulates the taxation provisions on capital gains and bond interest. The amount of income tax is different between resident and non-resident in the following ways:

1. Bond interest with coupon rate is 15% for local taxpayers and permanent establishment and 20%, or based on the rate on tax treaty, for foreign taxpayers apart from the Fixed Business Form and the gross amount of interest based on the period of bond ownership.
2. The discount from bond with coupon rate is 15% for local taxpayers and Fixed Business Form and 20%, or based on the rate on tax treaty, for foreign taxpayers apart from the Fixed Business Form and the difference of selling price or nominal value over the acquisition price of the bond, excluding accrued interest.
3. The discount from no coupon bond is 15% for local taxpayers and Fixed Business Form and 20%, or based on the rate on tax treaty, for foreign taxpayers apart from Fixed Business Form and the difference of selling price or nominal value over the acquisition price of the bond.

Recently, the MOF issued *Regulation No. 85/PMK.03/2011* concerning the procedure of withholding income tax, and payment and reporting on bonds interest. This regulation replaces *Regulation No. 121/KMK.03/2002* concerning the procedure of withholding income tax on interest-bearing bonds and discounted bonds, the trading of which is reported to the stock exchange. The salient items in the regulation are:

- a. Local pension funds and local resident banks are exempted from this tax regulation.
- b. The income tax on the interest of an interest-bearing debt securities is 15% for resident taxpayers and 20% for non-resident taxpayers (or in accordance with the relevant tax treaty agreement) from the gross interests based on holding period.
- c. The income tax on the discount of an interest-bearing debt securities is 15% for resident taxpayers and 20% for non-resident tax payers (or in accordance with the relevant tax treaty agreement) from the excess spread at selling price or from the nominal amount at bonds maturity against the acquisition price, excluding its accrued interest.

- d. The income tax on the discount of a non-interest-bearing debt securities is 15% for resident taxpayers and 20% for non-resident taxpayers (or in accordance with the relevant tax treaty agreement) from the excess spread between the selling price, or between the nominal amount at bonds maturity and the acquisition price.
- e. The income tax on interest and/or discounted bonds received by taxpayers of mutual funds registered at the Bapepam-LK is 0% from 2009 to 2010, 5% from 2011 to 2013, and 15% from 2014 onwards.
- f. Negative discount or capital loss cannot be included in the accrued interest calculation.

In addition, non-resident taxpayers must refer to the tax treaty agreements Indonesia signed with more than 50 countries.

B. Disclosure and Investor Protection Rules for Issuers

There are three rules on disclosure and investor protection for issuers. These are:

1. Documents concerning disclosure should be followed by support professionals registered with Bapepam-LK.
2. The legal jurisdiction for bonds issued by non-residents should be Indonesian law.
3. There are obligations to acquire investment ratings at the issuance of the bond, as prescribed by *Bapepam Rule No. IX.C.11*.

To conduct public offering of debt securities and/or sukuk, issuers should submit a Registration Statement and fulfill all disclosure requirements as set out in the Bapepam-LK rules. All support institutions and professionals involved in the public offering process should be registered with or licensed by Bapepam-LK. Following the public offering of debt securities and/or sukuk, the issuer is required to submit periodic or non-periodic reports such as quarterly reports on use of proceeds, annual reports, annual and semi-annual financial statements, periodic ratings, and reports on material facts. This obligation prevails as long as the debt securities and/or sukuk are still outstanding. Documents, such as financial statements and periodic ratings, are required to be issued or audited by independent professionals or institutions licensed by Bapepam-LK as prescribed by Bapepam-LK rules.

As for investor protection, Bapepam-LK requires each classification of debt securities to obtain annual ratings from a rating agency licensed by Bapepam-LK. This annual rating requirement is aimed to provide update on the quality of the securities, particularly those related with the ability of the issuer to fulfill its obligations to debt securities and/or sukuk holders. In addition to the rating requirement, Bapepam-LK rules also enable public issuance of debt securities and/or sukuk to be supported by a guarantor, who will cover the loss of the securities holders should the issuer fail to meet its obligation. The requirement to involve only support professionals and/or institutions registered with or licensed by Bapepam-LK in the public offering process is a way to ensure, among others, the independence, capacity, qualification, and responsibility of these professionals and/or institutions. However, from the point of view of global issuances, this requirement could represent a possible impediment and/or restrictions.

C. Underwriting Rules for Financial Institutions

Underwriters that are allowed to operate in Indonesia are those who hold a license from Bapepam-LK. According to *Bapepam Rule No. V.D.5 on Maintenance and Reporting of Adjusted Net Working Capital*, an underwriter should be more careful in conducting underwriting activities. Rule No. V.D.5 stipulates the obligation for underwriters to add ranking liabilities deducted on their adjusted net working capital if the underwriter makes a full commitment contract without proof of fund capabilities. In carrying out its activities, an underwriter shall also comply with *Bapepam Rule No. V.F.1* or the *Code of Conduct for Securities Companies Acting as Underwriters*.

According to *Bapepam Rule No. IX.C.1* regarding the form and content of a Registration Statement for a public offering and *Bapepam Rule No. IX.A.7 on Responsibilities of Underwriters With Respect to Subscriptions and Allotments of Securities in a Public Offering*, an issuer has an option whether to use an underwriter or not. The following are the rules that govern underwriting activities of financial institutions:

1. *Bapepam Rule No. V.A.1 on Licensing of a Securities Company*
2. *Bapepam Rule No. V.D.5 on Maintenance and Reporting of Adjusted Net Working Capital*
3. *Bapepam Rule No. V.F.1 on Code of Conduct for Securities Companies Acting as Underwriters*
4. *Bapepam Rule No. IX.C.1 on Form and Content of a Registration Statement for a Public Offering*
5. *Bapepam Rule No. IX.A.7 on Responsibilities of Underwriters with Respect to Subscriptions and Allotments of Securities in a Public Offering*

D. Credit Rating System and Its Relation to Regulations

There are obligations to acquire investment ratings at the issuance of the bond as prescribed by *Bapepam Regulation No. IX.C.1* and *Regulation No. IX.C.11*. The obligations are intended to provide investors and potential investors an independent opinion and information about the product offered or sold. Below are the rules concerning CRAs in Indonesia.

1. *V.C.2 Licensing of Rating Agency Company*
2. *V.H.3 Code of Conduct of Rating Agency Companies*
3. *V.H.4 Rating Agency Agreement Guidelines*
4. *X.F.4 Reporting by Rating Agency Company*
5. *X.F.5 Documents Maintenance by Rating Agency Company*
6. *X.F.6 Publications by Rating Agency Company*

E. Utilization of Shelf-Registration System

In order to facilitate the issuance of debt securities which allows a firm to issue a series of debt securities and/or sukuk within a particular period with only one submission of Registration Statement, Bapepam-LK released a new regulation on shelf registration (*Rule Number IX.A.15 on Continuing Public Offering [Shelf Registration]*).

F. Availability of Information in English

Most of the laws, presidential decrees, ministerial decrees, Bapepam-LK regulations, and other market-related information are available in English.

G. Restrictions in Accounting Standard

A financial report must be prepared based on the financial accounting standard set by the Financial Accounting Standard Board under the Indonesian Institute of Accountants, as well as on accounting provisions on the capital market as stated in *Bapepam-LK Rules No. VIII.G.7*.

H. Limited Opportunities to Utilize Bond Holdings and the Repo Market

Insurance companies and pension funds are prohibited from engaging in repo transactions based on *KMK No. 424/KMK.06/2003*.

J. Currency Controls

Central bank regulations prohibit the movements of the rupiah (1) between two non-resident accounts and (2) from residents to non-residents, unless the movements are related to economic activities in Indonesia, such as direct investments or transfers of ownership of direct investments and payments related to transactions involving rupiah-denominated securities. Offshore transfers of the rupiah are also prohibited. If the total accumulated funds credited to a non-resident account on a single given day exceeds IDR500 million, the investor must provide authenticated supporting documentation, such as a copy of the purchase or sale agreement for direct investments, a copy of the securities purchase or sale confirmation from a broker or other authorized party for securities portfolio transactions, or a copy of the dividend payment confirmation from the issuing company. For accumulated amounts under IDR500 million, supporting documentation is not required, but a declaration on the underlying economic transactions should be provided.

BI requires that all investors, who purchase foreign currencies against the rupiah in an amount greater than the equivalent of USD100,000 per calendar month, provide documents stating that all foreign exchanges are supported by underlying activities and a letter declaring the validity of all supporting documents provided. The declaration letter, which must include the customer's name, bank name, the nominal purchase of foreign currency against the rupiah, and a statement confirming the validity of the transaction, must be submitted to BI according to the following schedule:

Table 4.1 Schedule of Submission of Declaration Letter

Foreign Currency Purchase Amount	Frequency of Statement Letter			
	Non-Custody Clients		Custody Clients	
	Local	Foreign	Local	Foreign
Less than or equal to \$100,000 per month	Monthly	Monthly	Monthly	Once per calendar year
Greater than \$100,000 per month ^a	Per foreign exchange transaction on booking Date + supporting document	Per foreign exchange transaction on booking date + supporting document	Per FX transaction on booking date + supporting document	Once per calendar year + supporting document per foreign exchange transaction

^a Please note that the \$1 million limits are applicable to total outstanding transactions with all offshore customers of the bank. These include foreign exchange derivative transactions against the rupiah like outright forward sale/purchase, swaps and options, and other similar derivative transactions.
Notes: The exception to this rule is derivative transactions for hedging purposes. The term of the hedging contract must not be less than 3 months and not more than the term of the investment. It must be accompanied by documents supporting the underlying investment being hedged.
Source: Bank Indonesia.

For all the clients' purchases booked through the custodian's on-book account with the cash correspondent, the custodian will submit one blanket statement based on the above schedule to cover these purchases. Investors who do not abide by the above regulations are subject to a penalty of IDR10 million accompanied by a written warning letter for each offense. All non-resident foreign exchange transactions must be done onshore; offshore foreign exchange transactions are prohibited.

Onshore foreign exchange activities with non-residents are limited to \$1 million per bank on outstanding positions, unless there is an underlying economic activity as outlined above. A non-resident's rupiah current account cannot, under any circumstances, be overdrawn overnight.

BI also maintains a restriction on forward exchange trading. Forward transactions are allowed, provided that the value date of the forward transaction is the same as the settlement date of the underlying economic transaction, and the transactions are supported by authenticated documents. Hedging transactions are allowed only for the purpose of investment in Indonesia for a minimum tenor of 3 months and must be accompanied by documents supporting the hedging and investment.

Third-party foreign exchanges is allowed; however, supporting documentation for the underlying transactions must be provided to the third-party foreign exchange bank.

K. Funding Procedures

All cash trades are settled only if clear funds are available in the respective accounts. Local regulations do not permit an overdraft in non-resident investor accounts.

V. Description of the Securities Settlement System

A. Securities Settlement Infrastructure

Figure 5.1 Bond Settlement Infrastructure Diagram of Indonesia

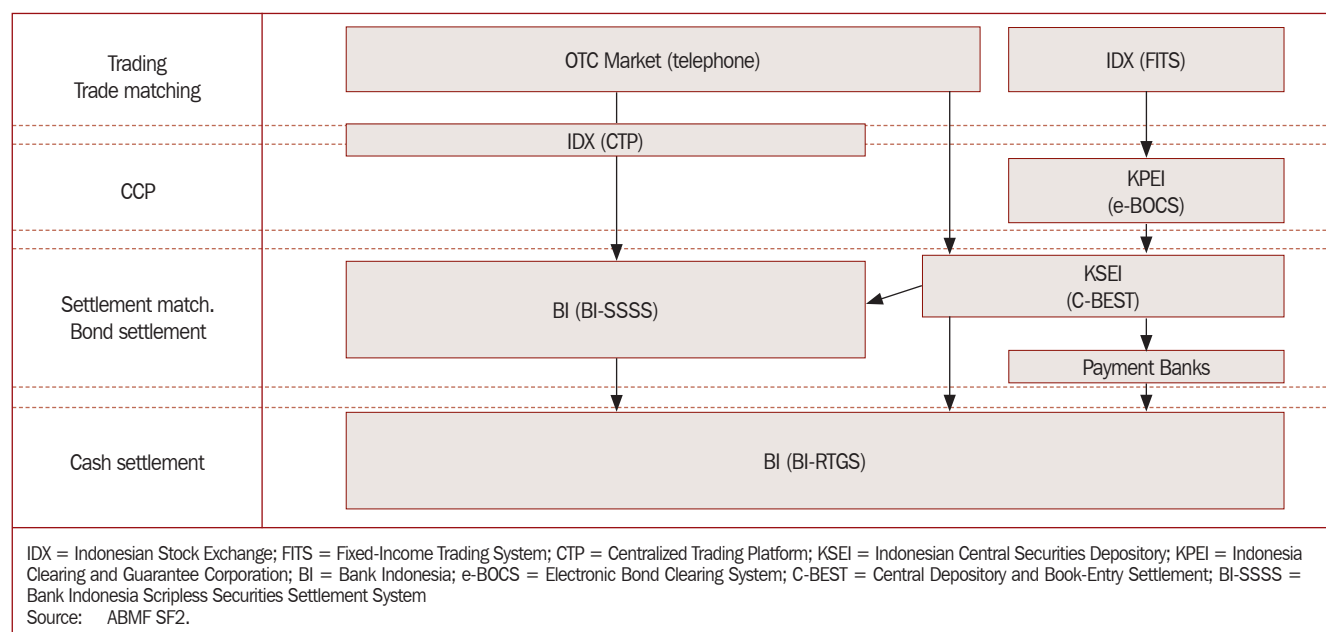

The securities settlement infrastructure in Indonesia is organized by the following two institutions:

1. Bank Indonesia

BI acts as a central registry in conducting the registration, clearing, settlement, payment, and redemption of government securities. It appoints a bank or financial institution as the sub-registry to operate as custodian for each individual customer account. To administer transactions for government securities and Sertifikat Bank Indonesia (SBI), BI employs the BI-SSSS. This system is an information portal that facilitates electronic auctions and the settlement of government securities for market

participants. It is linked seamlessly to BI's Real-Time Gross Settlement System (RTGS). As a result, transactions are conducted on a delivery-versus-payment (DVP) basis.

Figure 5.2 illustrates the OTC market business process flow with direct connection to BI-SSSS. The following are the explanations on the process flow in Figure 5.2.

Figure 5.2 Business Process Flowchart of the Indonesia Over-the-Counter Bond Market on a Delivery-versus-Payment Basis

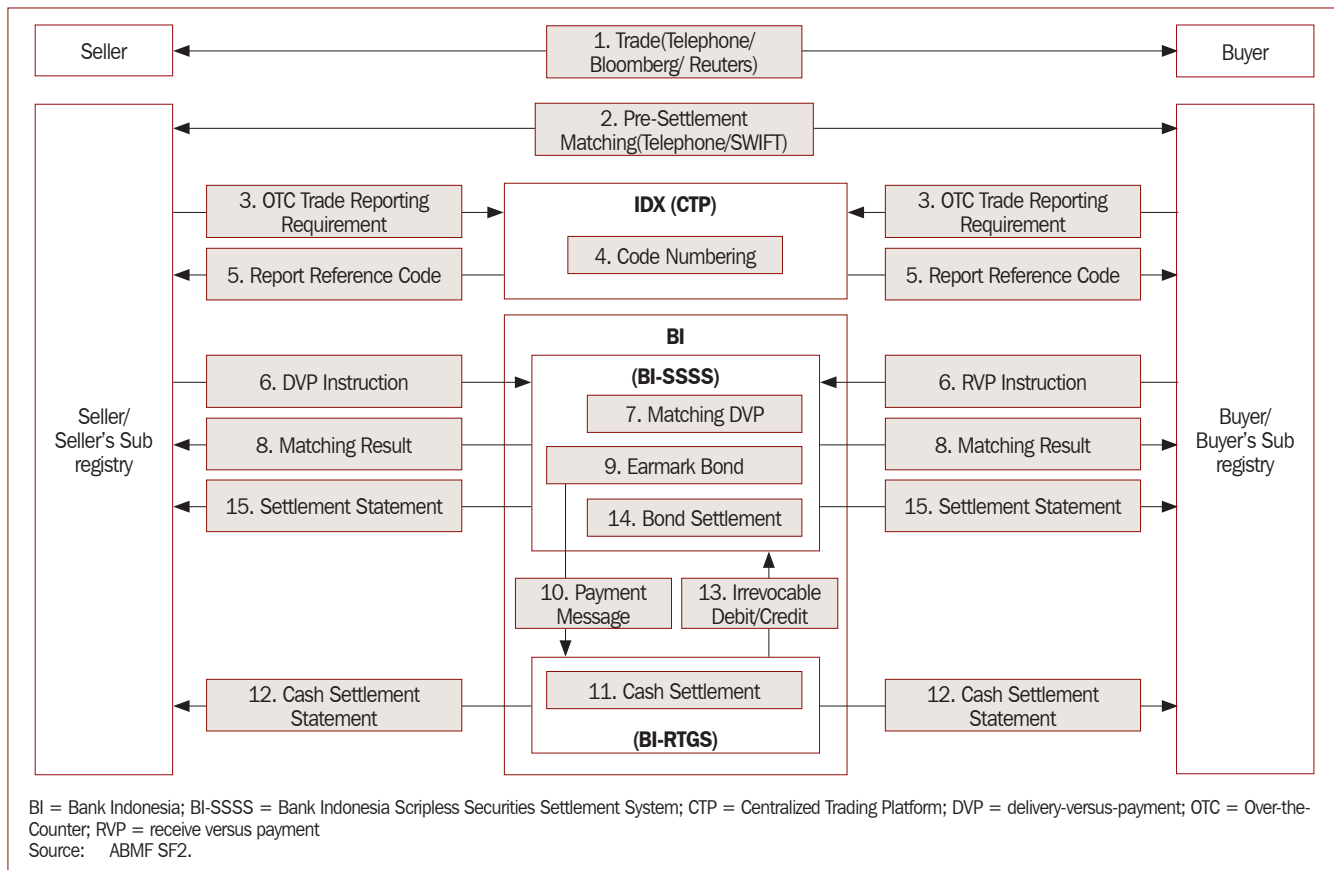

1. The seller and buyer trade government bonds over-the-counter. Most of trades are done by telephones.
2. Both seller and buyer send pre-settlement matching instructions over the SWIFT or pre-match the traded data for settlement over the telephone. Before the pre-settlement matching two components of bond taxes which are capital gain tax (CGT) and interest (withholding) tax need to be calculated. Pre-settlement matching is performed via telephone or swift.
3. The seller or buyer have to report trade data to Centralized Trading Platform (CTP) of Indonesia Stock Exchange (IDX) within 30 minutes of trade.
4. IDX puts the code on each trade.
5. The seller and buyer receive report reference code from IDX.
6. The seller and buyer key in the DVP and RVP instructions to BI-SSSS, respectively.
7. BI-SSSS performs the matching.
8. BI-SSSS reports the matching results to the seller and buyer.

9. Bond is earmarked to secure the DVP.
10. Payment message for DVP is sent to Bank Indonesia Real Time Gross Settlement (BI-RTGS)
11. When the funds are available, the amount is debited from the buyer's cash account and credited to the seller's cash account.
12. BI-RTGS sends the cash settlement statements to the seller and buyer.
13. BI-RTGS notifies the irrevocable debit/credit status to BI-SSSS.
14. BI-SSSS completes bond settlement.
15. BI-SSSS reports the settlement status to both seller and buyer.

BI-SSSS settlement does not have a built-in pre-matching concept; hence, pre-matching of transactions is done via phone. BI matching is based on either both parties' instruction input or upload instructions. Instructions for securities settlement and cash funding or payment would typically be given simultaneously; this is due to the need to link the foreign exchange with the underlying transaction and the need to prove funding before settlement is effected. Intraday facilities are generally permitted, and availability may depend on an intermediary. The straight-through processing (STP) concept is based on the BI-SSSS format, not international standards. BI is developing a next generation system, which may also support a segregated account structure.

2. Indonesian Central Securities Depository

The main functions of KSEI are the registration of listed corporate bonds and management of depository accounts. It also facilitates the settlement of securities from the Indonesian exchange. KSEI has been appointed by Bank Indonesia to act as a sub-registry handling government bonds. Thus, KSEI has become a member of BI-RTGS.

KSEI designed the C-BEST to carry out electronic registration and settlement of securities, including Shari'a bonds, multi-currency bonds, and promissory notes.

Under Indonesia's bond settlement system, pre-matching can be done either via telephone or the C-BEST system. KSEI can maintain accounts at an individual account-holder level, while maintaining an omnibus account at BI. No third-party access to KSEI is allowed; only brokers and custodians are allowed as participants.

All trades executed on the IDX FITS are routed to KPEI, the clearing house for CCP. Bond trades on the exchange are handled in the Electronic Bond Clearing System (e-BOCS), including allocations. Affirmations in the e-BOCS is only required for brokers. These trades are then settled in KSEI via C-BEST. The transaction status in C-BEST is available for viewing and is downloadable every 15 minutes. KSEI can settle transactions for bonds denominated in rupiah or US dollar.

Selling bonds attracts CGT. The seller's agent calculates the tax while the buyers' agent will withhold and pay the corresponding tax to tax authorities. As a result, the seller will need to amend the original instructions after calculation of tax impact. The documentation required to prove the applicable tax rate is complex. Two documents are submitted for documentation: 1) a COR or COD and 2) a certificate from the issuer. The COR or COD are renewed annually while the issuer certificate is valid only for 1

month. The withholding of tax is strictly on the basis of the supporting documents received. Some issuers are very strict while some are actively working with KSEI on solutions. KSEI is the withholding agent for government bond transactions.

For cash settlement, cash is settled via payment banks if settlements are made between KSEI account holders. In the settlement process, KSEI currently uses five payment banks: BCA, CIMB Niaga, Mandiri, Permata and BNI. Banks are chosen based on their strength, technology capabilities, and member benefits. KSEI recently arranged the intraday facilities from five payment banks to enable KSEI's participants (custodians and brokers) to withdraw the payment proceeds right after trades are settled in C-BEST, without waiting for the realignment process in C-BEST. With this arrangement, there will be no time lag between trade settled in C-BEST and cash received in the participant's account.

B. Definition of Clearing and Settlement

Clearing is defined under *Bapepam-LK Regulation No. III.A.10* regarding securities transactions as “a process of determining the rights and obligations that arise from Exchange transactions.” This is also stipulated in *KPEI Rule No. V-1 on Clearing and Transaction Settlement Guarantee of Debt Securities*. In addition, the fulfillment of rights and obligations is stipulated in *KPEI Rule No. V-1. 8.b*. The finality of settlement is also stipulated in *Exchange Rule No. II.F.3.5*.

The definition of settlement in KSEI regulation regarding central depository services is:

“Securities transaction settlement services are part of central depository services provided for the fulfillment of rights and obligations as the result of stock exchange transactions or over-the-counter transactions conducted by means of book-entry of securities and/or funds between securities accounts.”

VI. Cost and Charging Methods

This part discusses the maintenance (ongoing) costs and initial fees in the Indonesian bond market.

A. Market Costs

1. Stamp Duty

Stamp duty is applicable to registration fees. The following stamp duty is applicable to securities traded in Indonesia.

Table 6.1 Stamp Duty Fees for Securities (IDR)

Transaction Value	Stamp Duty
Less than IDR1 million	3,000
More than IDR1 million	6,000

Source: Deutsch Bank, 2010. Domestic Custody Services Market Guide, Indonesia.

2. Brokerage

For purchase or sale of securities, an investor is charged with a commission fee by the brokers. IDX does not prescribe any ceiling on brokerage fees. In such cases, the brokerage is mutually agreed between the investor and the broker.

3. Transaction Fees for Debt Securities Traded on the Exchange

a. Transaction Fees in the Regular Market

The transaction fees in the regular market are as follows:

- i. Transaction value of up to IDR500 million requires a transaction fee of IDR20,000 per transaction;
- ii. Transaction value of above IDR500 million to IDR10 billion has a transaction fee of 0.005% per transaction;
- iii. Transaction value above IDR10 billion has a transaction fee of 0.00375% per the transaction.

b. Transaction Fees in the Negotiations Market

Transaction fees in the negotiations market are as follows:

- a) Transaction value of up to IDR500 million corresponds to a transaction fee of IDR35,000 per transaction;
- b) Transaction value above IDR500 million to IDR10 billion has a transaction fee of 0.0075% per transaction;
- c) Transaction value above IDR10 billion has a transaction fee of 0.005% per transaction.

These fees are stipulated under *Exchange Rule No. II.F.2 on Commissions and Debt Securities Transaction Fees*.

B. Registration Costs

There are no registration costs applicable to dematerialized securities traded across the exchange. However, registration costs are applied if investors de-materialize securities that are held in physical form, or re-certificate securities held in dematerialized form. To de-materialize physical shares, the shares must be registered in the client's name. If the shares are not registered in the client's name, the client should provide a power of attorney (PoA) issued in the current registered name for the conversion process.

There is a registration fee of IDR2,000 to IDR10,000 plus 10% value-added tax (VAT) per certificate for physical share denominations up to 50,000. For physical certificate share denominations greater than 50,000, the registration fee is calculated using the formula

$$1/1000 \times \text{total nominal value}$$

where

$$\text{Total Nominal Value} = \text{Number of shares} \times \text{Nominal or par value of the shares},$$

with a minimum of IDR25,000 and a maximum of IDR10 million. There is also a conversion fee of IDR1,500 and IDR10,000 per certificate with a minimum fee of IDR20,000 plus 10% value-added tax. For physical certificate share denominations greater than 50,000, the conversion fee is calculated using the formula

$$1/1000 \times \text{total nominal value}$$

where

$$\text{Total Nominal Value} = \text{Number of shares} \times \text{Nominal or par value of the shares}$$

with a minimum of IDR25,000 and a maximum of IDR10 million.

A stamp duty is applicable on the total amount of registration fees on a registration application form. The stamp duty is generally payable by the investor and calculated based on the receipt for the registration fees.

Investors may withdraw their dematerialized holdings from KSEI and convert them into physical form. Such shares will be registered according to the name specified in the PoA. KSEI will charge a fee calculated as follows:

$$0.1\% \times \text{quantity} \times \text{closing market price},$$

subject to tax, with a minimum of IDR25,000 and a maximum of IDR500,000. The registrar will issue the scrip in a jumbo lot and charges a fee calculated as follows:

$$0.1\% \times \text{quantity} \times \text{nominal value},$$

subject to tax, with a minimum of IDR27,500 and a maximum of IDR550,000. The fee for splitting shares is IDR3,000 plus 10% VAT.

C. Listing Fees Charged by Exchanges

1. Corporate Bond and Sukuk

Security listing fees shall consist of initial listing fee and annual listing fee. The rates of initial listing fee and annual listing fee of debt securities are the same. Issuers that issue more than one type of debt securities in one issuance shall pay the initial and annual listing fee for each type of debt securities. The following listing fee rates are applicable to types of debt securities denominated in rupiah:

Table 6.2 Listing Fees per Type of Debt Securities

Total Nominal Amount of Debt Securities per Type	Listing Fee
Up to IDR200 billion	0.025% x Nominal
More than IDR200 billion up to IDR400 billion	0.024% x Nominal
More than IDR400 billion up to IDR600 billion	0.023% x Nominal
More than IDR600 billion	0.022% x Nominal
Source: ??????	

The listing fees above, in any case, shall not be lower than IDR10 million and not greater than IDR150 million. The listing fee of debt securities also applies to debt securities denominated in foreign currencies based on the nominal value after conversion into rupiah at the middle exchange rate of BI 8 exchange days before the date of debt securities listing, or 8 exchange days before the date of the listing anniversary. Provisions on initial and annual listing fees of municipal bonds shall follow those of the debt security listing fee.

2. Government Securities

Listing fee for government bonds shall only consist of initial listing fee. The exchange shall collect the initial listing fee from the Directorate General of Treasury of the MOF after the listing date. The listing fee for the government bonds shall amount to IDR100 million for each new issue or reopening valued at IDR1 trillion or more. Government bonds listing that constitutes a new issue and reopening valued at less than IDR1 trillion shall not be imposed with listing fees. The listing fee for government securities is exclusive of VAT.

The following Exchange Rules govern the listings fees in exchanges:

- a. *Exchange Rule No. I.A.5 regarding security listing fees;*
- b. *Exchange Rule No. I.F.2 regarding government securities listing; and*
- c. *Exchange Rule No. I.F.3 regarding municipal bond listing*

D. Other Costs

KSEI charges participants a transaction fee of IDR20,000 per transaction and a safe-keeping fee of 0.001% per annum from the market value. KSEI levies a dormant account fee of IDR1 million per month for any account that has no holdings and has not executed a trade for 6 months. If an investor closes a dormant account mid-month, the fee will be pro-rated. KSEI will give at least 30 days notice to allow investors an opportunity to close their accounts or to purchase securities before the charge is applied.

VII. Market Size and Statistics

Total local currency (LCY) bonds outstanding in Indonesia expanded 2.8% year-on-year as of the end of December 2010 reaching IDR956.1 trillion (USD106.3 billion). On a quarter-on-quarter basis, however, bonds outstanding fell 4.4% in the fourth quarter of 2010. As of the end of December 2010, the growth in total government bonds outstanding was flat on a year-on-year basis.

The 10.2% year-on-year growth in the stock of central government bonds (Treasury bills and bonds issued by the MOF) in the fourth quarter of 2010 was offset by the 23.0% year-on-year decline in the stock of central bank bills issued by BI in the form of SBI. Meanwhile, corporate bonds outstanding grew 29.8% year-on-year to IDR114.8 trillion (USD12.8 billion) in the fourth quarter of 2010.²⁵

A. Debt Securities and Sukuk Trade Reporting Data through PLTE (Indonesia Stock Exchange)

Table 7.1 Listed Bonds (Outstanding), 2008–September 2011 (IDR trillion)

Period	Listed Bonds (Outstanding)	
	Government Bonds	Corporate Bonds
As of September 2011	705.69	130.76
2010	641.21	115.34
2009	574.65	88.32
2008	525.69	72.97

Source: Bapepam-LK Statistics Department; Debt Management Office.

²⁵ Bapepam-LK. http://www.bapepam.go.id/pasar_modal/publikasi_pm/statistik_pm/index.htm

B. Debt Securities and Sukuk Outstanding Data

Table 7.2 Debt Securities and Sukuk Outstanding Data, 2008–2010
(IDR billion)

Period	Total Nominal Outstanding	
	Government Securities	Corporate Bonds and Sukuk
2010	641,214.61	115,840.57
2009	581,747.89	88,896.77
2008	525,694.73	73,010.00

Source: Bapepam-LK Statistics Department; Debt Management Office.

C. Composition of Bond Holding as of September 2011

Table 7.3 Composition of Bond Holdings as of September 2011
(IDR trillion)

Holding	Government Bond		Corporate Bond	
	Value	%	Value	%
Foreign	218.09	31.3	6.55	5.0
Local	478.47	68.7	123.03	95.0

Source: Bapepam-LK Statistics Department; Debt Management Office.

D. Type of investors for bonds as of September 2011

Table 7.4 Type of Investors of Bonds as of September 2011
(IDR billion)

Type of Investors	Government Bond		Corporate Bond	
	Value of Foreign Investors	Value of Local Investors	Value of Foreign investors	Value of Local Investors
Corporate	27.40	443.61	534.15	6,378.75
Individual	10.80	7,651.43	37.86	2,033.25
Mutual Fund	20.00	862.10	609.01	30,332.38
Securities Company	0.00	17.92	25.00	417.10
Insurance	0.00	294.45	17.00	31,755.42
Pension Fund	24.38	549.50	0.00	29,445.59
Financial Institution	5.00	196.97	3,720.82	21,112.46
Foundation	0.00	55.96	0.00	1,553.12
Others	133.50	53.93	1,609.46	5.50

Source: Bapepam-LK Statistics Department; Debt Management Office.

E. Size of Local Currency Bond Market in Percentage of Gross Domestic Product

Table 7.5 Size of Local Currency Bond Market (% GDP)

Size of LCY Bond Market in % GDP (Local Sources)						
Date	Government (% GDP)	Corporate (% GDP)	Total (% GDP)	Government (USD Billions)	Corporate (USD Billions)	Total (USD Billions)
Dec-97	0	2.4	2.4	0	2.81	2.81
Dec-98	0	1.4	1.4	0	1.73	1.73
Dec-99	30.3	1.3	31.5	46.86	2.00	48.85
Dec-00	35.4	1.4	36.8	50.84	1.95	52.79
Dec-01	29.8	1.1	31.0	47.22	1.81	49.03
Dec-02	26.2	1.2	27.4	53.30	2.40	55.70
Dec-03	24.7	2.3	27.0	59.09	5.39	64.48
Dec-04	21.9	2.6	24.5	54.28	6.34	60.62
Mar-05	19.5	2.4	21.9	49.26	6.17	55.43
Jun-05	20.3	2.5	22.7	51.85	6.29	58.14
Sep-05	17.1	2.3	19.4	43.48	5.78	49.26
Dec-05	17.1	2.1	19.2	48.27	5.88	54.14
Mar-06	18.2	2.0	20.2	58.81	6.33	65.14
Jun-06	18.7	2.0	20.7	62.07	6.52	68.59
Sep-06	18.8	1.9	20.7	65.62	6.57	72.19
Dec-06	18.8	1.8	20.7	69.87	6.84	76.71
Mar-07	19.6	1.8	21.4	74.70	6.86	81.56
Jun-07	19.6	2.1	21.8	78.81	8.47	87.28
Sep-07	19.5	2.1	21.6	80.72	8.86	89.58
Dec-07	18.4	2.0	20.4	77.26	8.42	85.67
Mar-08	17.1	2.0	19.1	76.79	9.11	85.90
Jun-08	15.6	1.9	17.5	74.27	8.94	83.21
Sep-08	14	1.7	15.7	69.29	8.19	77.48
Dec-08	14.3	1.5	15.7	63.47	6.57	70.04
Mar-09	15.1	1.4	16.5	66.61	6.27	72.88
Jun-09	14.8	1.5	16.3	76.99	7.83	84.82
Sep-09	14.5	1.4	15.9	81.54	8.17	89.70
Dec-09	15.0	1.6	16.6	89.50	9.41	98.90
Mar-10	15.4	1.6	17.0	98.18	10.13	108.31
Jun-10	14.9	1.6	16.5	98.34	10.25	108.59
Sep-10	14.4	1.7	16.1	100.30	11.58	111.87
Dec-10	13.1	1.8	14.9	93.70	12.76	106.46
Mar-11	13.6	1.8	15.4	103.93	13.91	117.85

Source: Asia Bonds Online. http://asianbondsonline.adb.org/indonesia/data/bondmarket.php?code=LCY_in_GDP_Local

F. Trading Volume

Table 7.6 Trading Volume of Government and Corporate Bonds (in USD billion)

Trading Volume			
Year	Govt Bonds	Corp Bonds	Total
Mar-05	8.46	0.34	8.80
Jun-05	7.90	0.32	8.22
Sep-05	7.07	0.35	7.42
Dec-05	3.10	0.21	3.31
Mar-06	8.83	0.21	9.04
Jun-06	8.62	0.13	8.75
Sep-06	10.89	0.46	11.35
Dec-06	10.84	1.04	11.88
Mar-07	13.85	0.79	14.64
Jun-07	22.37	1.08	23.45
Sep-07	18.88	1.15	20.03
Dec-07	14.86	0.75	15.61
Mar-08	13.41	0.77	14.18
Jun-08	13.88	0.84	14.72
Sep-08	14.41	0.73	15.14
Dec-08	8.06	0.43	8.49
Mar-09	6.66	0.33	6.99
Jun-09	10.24	0.50	10.74
Sep-09	9.30	0.38	9.68
Dec-09	13.59	0.72	14.31
Mar-10	18.08	1.16	19.24
Jun-10	22.99	1.23	24.22
Sep-10	19.48	1.40	20.88
Dec-10	19.11	1.21	20.32
Mar-11	24.17	1.41	25.58

Source: Asia Bonds Online. http://asianbondsonline.adb.org/indonesia/data/bondmarket.php?code=Trading_Volume

VIII. Presence of an Islamic Finance (Islamic Bond [*Sukuk*]) Market

A. Definition

Law No. 8/1995 concerning the capital market (UUPM) defines “capital market” as “an activity concerned with the public offering and trading of securities, the Public Company relating to the issuance of securities, as well as the institutions and professions related to securities.” Based on this definition, the terminology of Shari’a capital market can be defined as the activity in capital markets as provided for in UUPM that does not conflict with Shari’a principles. Therefore, the Shari’a capital market is not a separate system from the capital market as a whole. In general, the Shari’a capital market activity is no different with the conventional capital market, but there are some special characteristics of the Shari’a capital market products in that the transaction mechanisms do not conflict with Shari’a principles.

B. Shari’a Principles

The application of Shari’a principles in the stock market certainly springs from the Koran as the supreme source of law and tradition of the Prophet Muhammad. Furthermore, from these two sources of legal interpretation is the so-called *fiqih*. One of the discussions in *fiqih* is about *muamalah*, which is the relationship among human beings and all their acts and interconnections that includes financial activities. Based on the Shari’a, capital market activities are developed on the basis of *fiqih muamalah*. The rule which states that, “In essence, all forms of *muamalah* be done unless there is proof (*dalil*) that it is otherwise (*haram*).” This is the basic principle of the Shari’a capital market in Indonesia. Moreover, Bapepam-LK defined Shari’a Principles in the Capital Market as the principles of Islamic laws in capital market activities based on the *fatwa* of the National Shari’a Board—the Indonesian Ulama Council (DSN-MUI) which do not violate Bapepam-LK rules.

C. Rules

1. Rule No. II.K.1 on Criteria and Publishing List of Shari'a Securities

The list of Shari'a Securities (DES) is a collection of securities that do not conflict with Shari'a principles in the capital market, which is set by Bapepam-LK or parties approved by Bapepam-LK. Currently, DES consists of the Shari'a stock list and other Shari'a securities. DES is a mutual fund investment guide for the Shari'a in placing funds under its management and can also be used by investors who have a desire to invest in the securities portfolio of the Shari'a. There are two types of DES:

a. Periodic DES

A periodic DES is published periodically, i.e., at the end of May and November each year. It was first published by Bapepam-LK in 2007.

b. DES Incidental

Incidental DES is not published regularly. It is issued when:

- i. The determination of stocks meets the criteria of Shari'a securities simultaneously with the issuers of an effective Registration Statement conducting initial public offering or a public company registration statement.
- ii. The determination of stocks of the issuer and public companies that meet the criteria of Shari'a securities based on periodic financial reports submitted to Bapepam-LK after the DES decree is periodically determined.

2. Rule No. IX.A.13 on Shari'a Securities Issuance

This rule regulates the issuance process and requirements needed to be fulfilled in issuing Shari'a securities. The securities, among others are:

- i. Stocks;
- ii. Mutual funds Shari'a, which is defined in the *Capital Market Law* and its implementing regulations that states that the management does not conflict with Shari'a principles in the capital market;
- iii. Asset-Backed Securities Collective Investment Contract Shari'a; and
- iv. Corporate sukuk.

In principle, the procedure and documents are the same with other Shari'a securities, and, in addition, those securities definitely have to comply with Shari'a principles.

3. Rule No. IX.A.14 on contracts (akad) used in the issuance of Shari'a securities in the capital market

This rule regulates the contracts (akad) that can be used in the issuance of Shari'a securities. The types of contract are Ijarah, Kafalah, Mudharabah, and Wakalah.

D. Fatwa and the Legal Basis of Islamic Bonds (Sukuk) in Indonesia

The following form the fatwa and legal basis of Islamic bonds (sukuk) in Indonesia.

1. *Fatwa No. 32/DSN-MUI/IX/2002 concerning Shari'a Bonds*
2. *Fatwa No. 33/DSN-MUI/IX/2002 concerning Shari'a Mudharabah Bonds*

3. *Fatwa No. 40/DSN-MUI/X/2003 concerning the Capital Market and the General Guidelines for Implementation of Shari'a in the Capital Market*
4. *Fatwa No. 41/DSN-MUI/III/2004 concerning Shari'a Ijarah Bonds*
5. *Fatwa No. 59/DSN-MUI/V/2007 concerning conversion of Shari'a Mudharabah Bonds*
6. *Fatwa No. 69/DSN-MUI/VI/2008 concerning of the Government Shari'a Securities (SBSN)*
7. *Fatwa No. 70/DSN-MUI/VI/2008 concerning the method of SBSN Issuance*
8. *Fatwa No. 72/DSN-MUI/VI/2008 concerning Sale and Lease Back of Ijarah SBSN*

E. Regulations on Domestic and International Issuance of Government Sukuk

1. Domestic Issuance

- a. Bookbuilding for Sovereign Sukuk (*Finance Minister Regulation No. 118/PMK.08/2008 on Issuance and Sale of SBSN in Domestic Primary Market through Bookbuilding*);
- b. Book Building for Sovereign Retail Sukuk (*Finance Minister Regulation No. 218/PMK.08/2008 on Issuance and Sale of Retail SBSN in Domestic Primary Market*);
- c. Auction (*Finance Minister Regulation No. 11/PMK.08/2009 on Issuance and Sale of SBSN in Domestic Primary Market through Auction*); and
- d. Private Placement (*Finance Minister Regulation No. 75/PMK.08/2009 concerning Issuance and Sale of SBSN through Private Placement*)

2. International Issuance

- a. Book Building (*Finance Minister Regulation No. 152/PMK.08/2008 concerning SBSN Issuance in Foreign-Currency Denomination in the International Primary Market with changes reflected in Finance Minister Regulation No. 129/PMK.08/2009*);
- b. Private Placement (*Finance Minister Regulation No. 75/PMK.08/2009 concerning Issuance and Sale of SBSN through Private Placement*)

F. Statistics

Table 8.1 Statistics on the Islamic Finance Market in Indonesia (2007–2011)

Group of asset	2007	2008	2009	2010	2011
Sharia Insurance (as of March 2011)	1,889.00	2,669.00	4,803.00	6,974.00	7,840.00
Sukuk (Islamic Bonds) (as of September 2011)	3,174.00	5,498.00	7,015.00	7,815.00	7,915.40
Sharia Mutual Funds (as of September 2011)	2,203.00	1,814.80	4,629.22	5,225.78	5,358.85
Government Sukuk (as of September 2011)	not available	4,699.70	20,329.00	44,344.00	64,782.51
Sharia Banking (as of June 2011)	36,538.00	49,555.00	66,090.00	97,519.00	109,750.00
Total asset of Sharia Financial Industry	43,538.90	64,236.50	102,866.22	161,877.78	195,646.76
Percentage of growth		46.64	60.14	57.37	20.76

* Including global sovereign Sukuk of USD650 million or approximately IDR6,500.00 billion (USD1=IDR9,325) and government sukuk are not tradable.

Figures 8.1 The Development of Sukuk Issuance and Outstanding Sukuk (Shari'a Bonds)

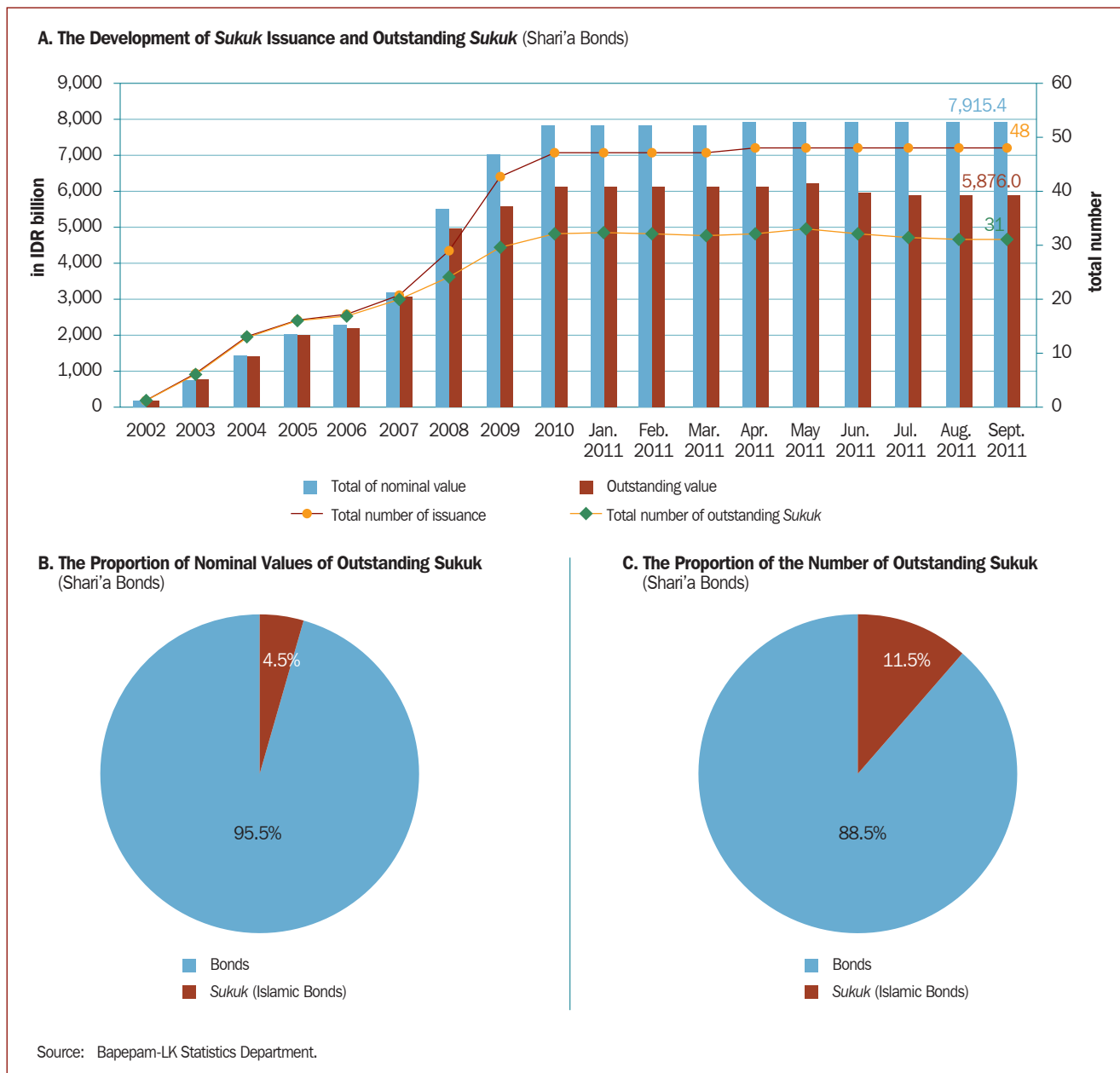

Figure 8.2 The Profile of Corporate Sukuk Investors

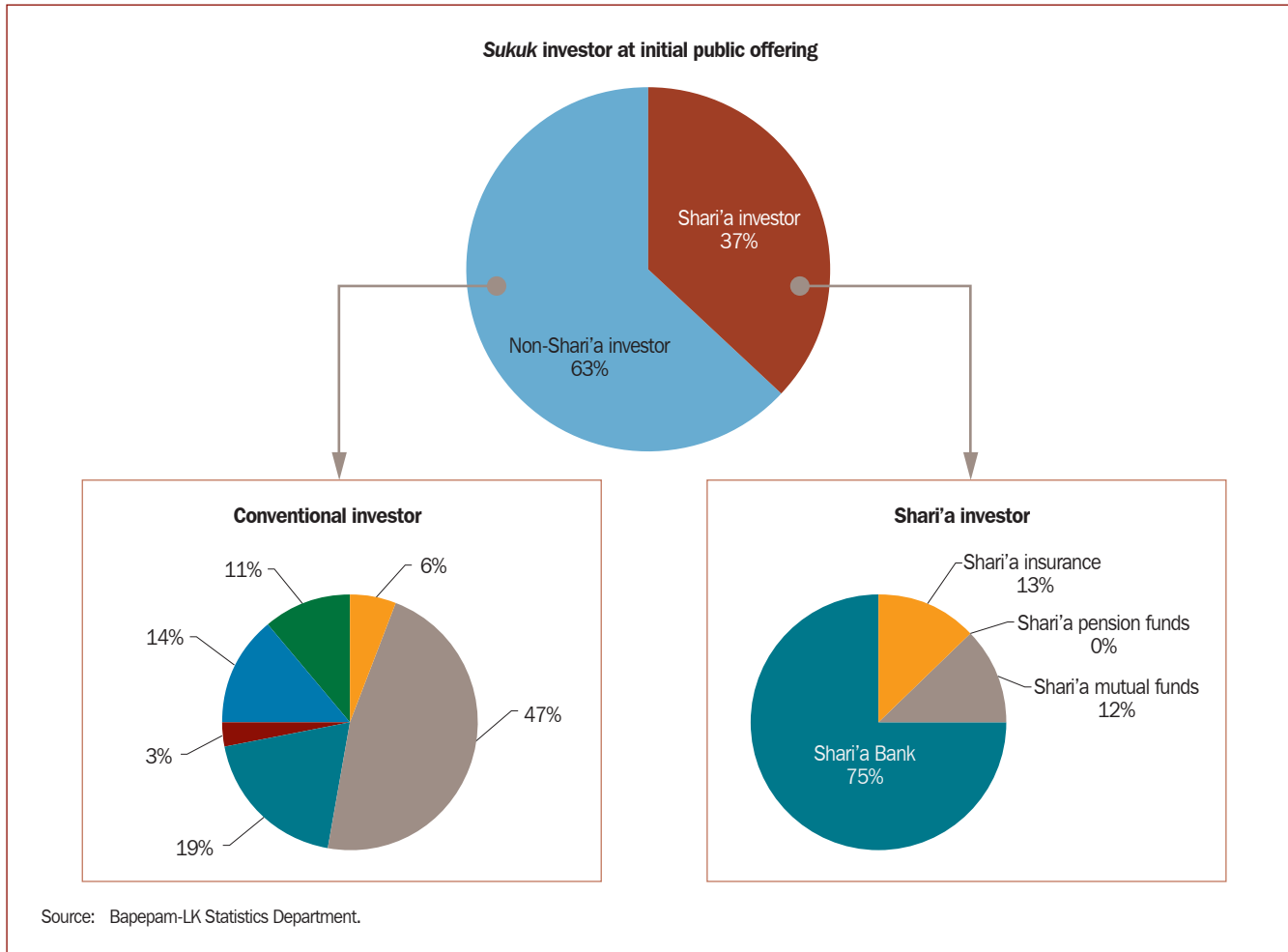
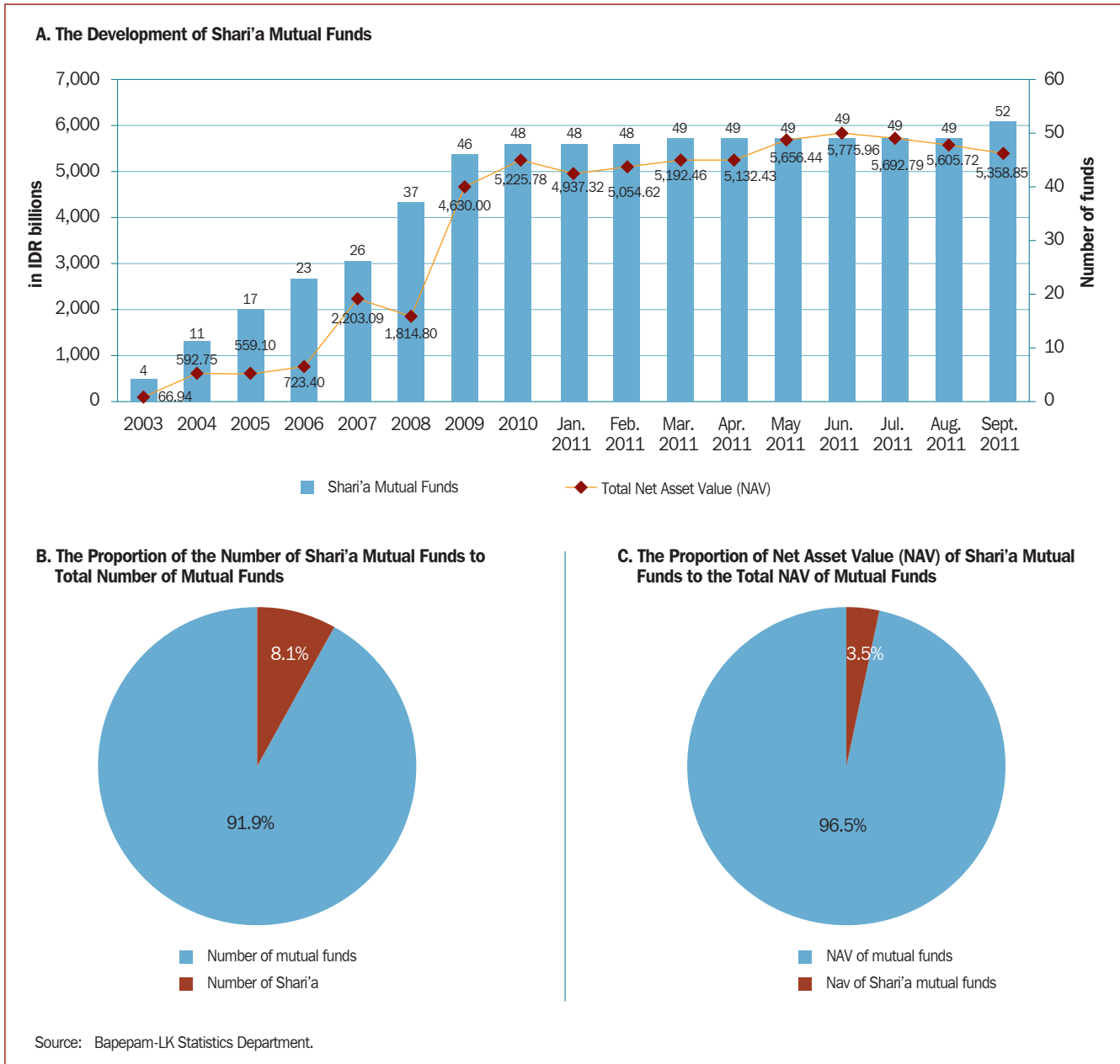

Figure 8.3 The Development of Shari'a Mutual Funds



IX. History of Debt Market Development

In the history of the Indonesian capital market, shares and bonds trading began since the early 19th century. On 14 December 1912, *Amsterdamse Effectenbueurs* established a stock exchange branch in Batavia. In Asia, the exchange was the fourth established after those in Bombay, Hong Kong, and Tokyo. The stocks traded were shares and bonds of Netherlands firms and/or plantations in Indonesia, bonds issued by the government (provinces and municipalities), securities certificates of American companies issued by the administrative offices in Netherlands, and bonds of other firms from the Netherlands.

A. Corporate Debt Securities

During the first 10 years since the reactivation of the Indonesian capital market in 1977, there were nine companies that conducted a public offering of bonds with a total offering value of IDR936 billion. This value was far greater than the offering value of shares which was IDR174 billion. Until 1996, 55 companies conducted public offering of bonds, with an offering value of IDR11.54 trillion. During the period of 1999 to 2010, the average growth of the number of debt securities issuers in Indonesia was 6.39% annually, while the issue amount had grown 22.6% annually on average. Until the end of 2010, 189 companies have conducted bond public offerings with a total value of IDR709.82 trillion.

In 2002, the first corporate sukuk was offered in the Indonesian capital market. Since the first offering, the number of sukuk public offerings has increased steadily. Until the end of 2010, 47 sukuk have been offered to the public with a total offering value of IDR7.8 trillion.

B. Government Debt Securities

The debt market in Indonesia has shown significant growth with the issuance of recap bonds by the government in 1999 and the commencement of recap bonds trading in the secondary market in 2000. The condition of the Indonesian macroeconomy, which

was marked by a decreasing interest rate, has also highly supported the development of the debt market at that time. The increasingly diverse types and total value of debt securities and sukuk instruments issued by the government, as well as those issued by corporates, also marked the growth of the Indonesian debt market. Such diverse types encompass fixed rate, variable rate, zero coupon, retail, treasury notes, and sukuk of government securities, all in rupiah as well as in US dollars and Japanese yen. The value of recap bonds, later on referred to as government debt securities, traded in the secondary market had grown significantly from IDR31.6 trillion in 2000 to around IDR712 trillion by the end of October 2011.

The amount of outstanding debt securities and sukuk issued by the government and the corporate sector traded in the secondary market year-on-year had also shown remarkable growth from approximately IDR49 trillion in 2000 to approximately IDR832 trillion in October 2011. As of October 2011, there were 85 series of government debt securities and sukuk and 268 series of corporate debt securities and sukuk in the market.

To improve the infrastructure and for better price-discovery mechanism, Bapepam has set as priority the development of the bond market under three main objectives or pillars, namely:

1. Develop primary dealers by designing a merit-based cross industry that bridge the capital market industry and the banking industry, as well as by implementing a product standardization program.
2. Develop reporting and collection of trade data by issuing regulation regarding reporting obligations and reporting platform, and the establishment of the Bond Pricing Agency (BPA). The goals of this pillar are to create a debt securities benchmark and to encourage market transparency and ensure the existence of professional responsibility and independence in the process of price formation or bonds valuation.
3. Develop an electronic trading system by taking into account the existence of the retail market.

The development in the debt market had a positive influence on encouraged the long-term investment climate. This was indicated by the growth and diversity of debt securities- and sukuk-based instruments such as mutual funds, unit-linked, bank assurance, ABS, and others. The increasing growth of the Indonesian debt market is the real evidence of the important role of debt securities as fiscal and monetary instruments for the government, as well as funding and investment instruments for the corporate and business sectors.

X. Next Steps

1. Development Plans

A masterplan laid out the big picture desired for technology and market developments such as:

1. BI Next Generation System project, which consists of the development of the BI-SSSS and BI-RTGS.
2. Bapepam, BI and market players are in cooperation to develop the repo market by establishing the Global Master Repo Agreement (GMRA) with Indonesia Annex, which will use international standards adapted to the Indonesian market.
3. Optimizing the functions of IBPA in assessing the price of debt securities, sukuk, and other securities, as well as expanding the use of products of IBPA in financial markets.

KSEI already introduced AKSES, which allows investors to check all their holdings with KSEI, and across intermediaries by using the new Single Investor ID (SID), as long as all custodians or brokers for the same client use the SID. However, AKSES still could not yet facilitate government bond investors who are not sub-account holders in KSEI.

In January 2011, the MOF and the State Enterprises Ministry signed a memorandum of understanding requiring state-owned firms to act as stand-by purchasers of government bonds in the event of sudden capital outflows. Under the scheme, a bond stabilization fund will be created to help protect the economy in case of sudden capital flight. The government has appointed 13 major state companies and financial institutions to participate in the bond stabilization fund. These comprise four banks (Bank Mandiri, Bank Rakyat Indonesia, Bank Negara Indonesia, and Bank Tabungan Negara), and nine non-banks and insurance companies (including Jaminan Kredit Indonesia and Asuransi Kredit Indonesia).

2. Market Development

The concept of a financial sector supervisory agency (i.e., the convergence of supervisory powers into a single agency) is planned, but slow moving. Several major desirable developments, including a possible convergence of depositories into a single entity, should not be expected before the conclusion of implementation. Please refer to the “Indonesia Capital Market and Financial Institution Master Plan,” which can be accessed through the Bapepam website.²⁶

3. G-30 Compliance²⁷

The so-called G-30 Recommendations were originally conceived as the Group of Thirty’s Standards on Securities Settlement Systems in 1989, detailing in a first of its kind report, nine recommendations for efficient and effective securities markets and covering legal, structural and settlement process areas. The recommendations were subsequently reviewed and updated in 2001, under the leadership of the Bank for International Settlements (BIS), and through the efforts of a Joint Task Force of the Committee on Payment and Settlement Systems (CRSS) and the Technical Committee of the International Organization of Securities Commissions (IOSCO). Compliance with the G30 recommendations in individual markets is often an integral part in securities industry participants’ and intermediaries’ due diligence process.

Table 10.1 Group of Thirty Compliance Recommendations

	Recommendation	Implemented
1	Eliminate paper and automate communication, data capture, and enrichment.	Yes
2	Harmonize messaging standards and communication protocols.	No
3	Develop and implement reference data standards.	Yes
4	Synchronize timing between different clearing and settlement systems and associated payment and foreign exchange systems.	Yes
5	Automate and standardize institutional trade matching.	No
6	Expand the use of central counterparties.	Yes
7	Permit securities lending and borrowing to expedite settlement.	Yes
8	Automate and standardize asset servicing processes, including corporate actions, tax relief arrangements, and restrictions on foreign ownership.	No
9	Ensure the financial integrity of providers of clearing and settlement services.	Yes
10	Reinforce the risk management practices of users of clearing and settlement service providers.	No
11	Ensure final, simultaneous transfer and availability of assets.	Yes
12	Ensure effective business continuity and disaster recovery planning.	No
13	Address the possibility of failure of a systematically important institution.	No
14	Strengthen assessment of the enforceability of contracts.	Yes
15	Advance legal certainty over rights to securities, cash, or collateral.	Yes
16	Recognize and support improved valuation methodologies and closeout netting arrangements.	Yes
17	Ensure appointment of appropriately experienced and senior board members (of the boards of securities clearing and settlement infrastructure providers).	Yes
18	Promote fair access to securities clearing and settlement networks.	Yes
19	Ensure equitable and effective attention to stakeholder interests.	Yes
20	Encourage consistent regulation and oversight of securities clearing and settlement service providers.	Yes

Source: Self-assessment 2011 of ABMF National Members from Indonesia, on basis of G30 recommendations.

²⁶ Bapepam-LK. 2010. *Indonesia Capital Market and Financial Institution Master Plan*. http://www.bapepam.go.id/pasar_modal/publikasi_pm/info_pm/MASTERPLAN_BAPEPAMLK_2010-2014.pdf

²⁷ Group of 30 (G30). 2003. *Global Clearing and Settlement – A Plan of Action*. <http://www.partad.ru/wrld/word/g30app1.pdf>

4. Group of Experts Final Report: Summary of Barriers Market Assessment (April 2010)

The GoE Report refers to the published results in 2010 of the Group of Experts (GoE) formed under Task Force 4 of the Asian Bond Market Initiative (ABMI). In the report, published under the leadership of the Asian Development Bank (ADB), a group of securities market experts from the private and public sector in ASEAN+3, as well as International Experts, assessed the ASEAN+3 securities markets on potential market barriers, the costs for cross-border bond transactions, and the feasibility for the establishment of a Regional Settlement Intermediary (RSI). The findings in the GoE Report lead to the creation of ABMF.

Table 10.2 below summarizes the Group of Experts (GOE) Final Report on barriers market assessment for Indonesia as of April 2010.

Table 10.2 Summary of Barriers Market Assessment – Indonesia (April 2010)

Potential Barrier Area	Current Situation	Market Assessment Questionnaire Scores	Overall Barrier Assessment
Quotas	There are no quotas on foreign involvement in the local market. There are no significant limits on foreign investor holdings in individual issues.	OK	OK
Investor registration	There is no requirement for foreign investor registration.	OK	OK
FX controls - conversion	<p>Foreign exchange activities of each bank are restricted to 20% of total capital per day, shared between the bank's customers.</p> <p>Offshore foreign exchange transactions are prohibited.</p> <p>Third-party FX trades are allowed. However, given the restrictions and risks associated with the movement of funds in the market, custodians may not support third party FX.</p> <p>Investors who purchase foreign currencies against IDR more than the equivalent of USD 100,000 per calendar month must make a declaration stating that all FX activity is supported by underlying investments and a letter declaring the validity of all supporting documents provided. Non-resident custody clients can provide an annual blanket confirmation.</p> <p>Reports on IDR transfers are submitted on a monthly basis by custodian banks. Reports on FX transactions effected are submitted on a daily basis. Comments from market participants indicated some investor perception of these currency controls being problematic. 8 survey responses mentioned Indonesia as a problem in this area.</p>	HIGH	HIGH
FX controls - repatriation of funds	<p>Similar controls are imposed on repatriation of funds.</p> <p>6 survey responses mentioned Indonesia as a problem in this area.</p>	LOW	LOW
Cash controls - credit balances	<p>IDR received from an FX which is to be used for the purchase of securities can only be held in the non-resident account for a maximum of 2 working days. Failed trades are not common in the Indonesian market, but should a purchase trade not have settled by SD+1, the custodian will be forced to reverse the initial FX and sell the IDR same-day. The IDR cannot remain in the account, although it can be used to fund another purchase.</p> <p>There are significant restrictions on credit balances, but some flexibility.</p>	LOW	LOW

continued on next page

Table 10.2 continuation

Potential Barrier Area	Current Situation	Market Assessment Questionnaire Scores	Overall Barrier Assessment
Cash controls - overdrafts	<p>A non-resident's IDR current account cannot, under any circumstances, be overdrawn overnight.</p> <p>Intra-day overdrafts are allowed. However, in practice, sales proceeds cannot be used to fund purchases of the same value date due to limited cut-off time of securities settlement. Therefore, while pre-funding in the sense that funds are needed prior to settlement date is not required, foreign investors must ensure that sufficient IDR funds are in their account on SD, without allowing for any sales proceeds due in that day, to ensure purchases are settled.</p>	LOW	HIGH
Taxes	<p>Withholding taxes are applied both when selling bonds and at the maturity of bonds. Market participants need to track historic trades in order to calculate the tax on a sale.</p> <p>For foreign investors, the standard rate of withholding tax is 20%. Double-taxation treaties can reduce this to 10%. Exemption is currently obtained by submitting an original Certificate of Domicile/Residency. Additional documentation may be required under the new Indonesian income tax law (as from 1 January 2009), but the implementation guidelines have not yet been issued.</p> <p>It appears there are ambiguities in the tax regulations in Indonesia and tax reclaim is a cumbersome and lengthy process. Investors commented that tax is complex and high and terminology can be unclear. 6 survey responses mentioned Indonesia as a problem in this area. It was also mentioned that there have been some improvements in recent years.</p>	HIGH	HIGH
Omnibus accounts	Omnibus accounts are permitted. However, for tax reasons it may be advisable to open individual accounts, and many investors now do so.	OK	OK
Settlement cycle	The settlement cycle for bonds is negotiated, normally on T+2, but can be settled between T+1 to T+7.	OK	OK
Message formats	The CSD, and most local market participants, do not currently use ISO 15022 / 20022 message formats.	LOW	LOW
Securities numbering	ISIN codes are available for all local bond issues, and are available at the time of issue. However, the CSD, and most local market participants, do not currently use ISIN codes in securities messages.	LOW	LOW
Matching	There are trade matching and pre-settlement matching systems for bonds.	OK	OK
Dematerialisation	The market is basically dematerialised but some physical bond certificates still exist (if issued prior to 2000).	LOW	LOW
Regulatory framework	<p>Perceived regulatory risk, especially fear of capital controls, is a factor in investors' minds.</p> <p>It was commented that immediate regulatory changes are often made, and rules can be ambiguous.</p>	–	HIGH

Source: Group of Experts (GoE) Final Report: Summary of Barriers Market Assessment – Indonesia (April 2010). [https://wpqr1.adb.org/LotusQuickr/asean3goe/Main.nsf/h_58E34A1388F9070B48257729000C0A4E/90F408746827C16248257729000C1334/\\$file/Part3.pdf](https://wpqr1.adb.org/LotusQuickr/asean3goe/Main.nsf/h_58E34A1388F9070B48257729000C0A4E/90F408746827C16248257729000C1334/$file/Part3.pdf)

Japan Bond Market Guide

Contents

Acknowledgements	vii
I. Structure, Type, and Characteristics of the Bond Market	1
A. Overview	1
B. Types of Bonds	2
C. Explanation of the Major Types of Bonds	3
D. Securitized Products Market	5
E. Methods of Issuing Bonds Other than Corporate Bonds	9
F. Methods of issuing Corporate Bonds	13
G. Credit-Rating Agencies and Credit Rating of Bonds	14
H. Introduction of the Register System for Credit-Rating Agencies in Japan	15
I. Market Category: Public Offering and Private Placement	20
J. Definition of the Specified (Professional) Investor	23
K. Creation of the New Market for Specified (Professional) Investor	24
L. TOKYO PRO-BOND Market: New Listing System in Japan	24
M. Commissioned Company for Bondholders System	28
N. Japan Securities Dealers Association's Self-Regulatory Rules and Guidelines for the Bond Market	30
O. Tokyo Stock Exchange's Self-Regulatory Function	32
P. TOKYO AIM's Role as TOKYO PRO-BOND Market Self-Regulatory Organization	33
Q. Bankruptcy Procedures and Bonds	33
R. Legal Definition of Debt Instruments	34
II. Disclosure Requirements	36
A. Securities Registration Statement	36
B. Methods of Filing the Securities Registration Statement	37
C. Continuous Disclosure	38
D. Forms of Initial Disclosure by Foreign Issuers	38
E. Electronic Disclosure for Investors' Network	39
F. Exempted Securities	39
III. Trading of Bonds	40
A. Overview	40
B. Participants in the Secondary Bond Market	41

C. Over-the-Counter Trading of Bonds	44
D. Publication of Reference Statistical Prices for Over-the-Counter Bond Trading	44
E. Secondary Market Yields and Terms of Bond Issues.....	46
F. Repurchase (Gensaki) Market for Bonds	48
G. Bond Lending.....	50
H. Proprietary Trading System for Fixed-Income Securities	52
IV. Bond Market Infrastructure	56
A. Bond Market Infrastructure Diagram and Business Process Flowchart	56
B. Over-the-Counter Bond Transaction Flow for Foreign Investors (Including Cross-Border, Funding, and Reporting Components)	58
V. Securities Settlement Infrastructure	60
A. Securities Settlement Infrastructure.....	60
B. Challenges and Expected Changes	64
C. Details of the Book-Entry Bond Transfer System	64
VI. Current Japanese Market Situation	71
A. Tide for the Change	71
B. Current Conditions of the Japanese Corporate Bond Market.....	71
C. Factors Characterizing Corporate Bond Market and Its Problems	74
D. Reducing the Blackout Period and Expansion of Funding Sources.....	78
E. Inconvenience of the Current Disclosure System for Public Offering.....	78
F. Due Diligence by Securities Companies	79
G. Determination Process for Corporate Bond Issuance Conditions	79
H. Measures to Cope with Default Risk	80
I. Taxation (Withholding Tax on Interest Income)	84
J. Bond Investment Education and Bond Investor Relations	84
K. Internationalization of the Bond Market and Collaboration with Asia.....	85
L. Foreign Bonds, Foreign Exchange Control and Liberalization of the Yen	85
M. History of Japan's Foreign-Exchange Policy Change and the Liberalization of the Yen	86
N. Derivatives Market.....	87
VII. Fees and Costs	90
A. Standard Underwriting Fees Schedule for Public Offering Bonds	90
B. Book-Entry and Transfer Fees (JASDEC Account Holding Issuer, etc.)	90
C. Fee to the Fiscal Agent and/or Paying Agent	95
D. Standard Fiscal Agent Fee for Public Offering of Corporate Bonds	95
E. Others.....	95
VIII. Market Statistics	96
A. Overview	96
B. Outstanding Amount of Bonds Issued in Japan	98
C. Size of Local Currency Bond Market in U.S. Dollars.....	99
D. Size of Local Currency Bond Market in Percentage of Gross Domestic Product.....	100
E. Size of Foreign Currency Bond Market in U.S. Dollars (Bank for International Settlement)	101
F. Size of FCY Bond Market in Percentage of Gross Domestic Product (Bank for International Settlement)	102
G. Size of Foreign Currency Bond Market in U.S. Dollars (Local Sources)	103

H. Foreign Holdings in Local Currency Government Bonds.....	104
I. Domestic Financing Profile.....	106
J. Trading Volume.....	106
IX. Islamic Finance in Japan.....	108
A. Background on Introducing Islamic Finance in Japan.....	108
B. Regulatory Framework for Islamic Finance in General.....	109
C. Regulatory and Legal Framework for Islamic Bonds (Sukuk).....	109
D. Type of Instruments Available, Segments, and Tenure.....	112
E. Tax-Related Issues.....	112
F. Impediments for Structuring Sukuk.....	113
G. Significance of the Islamic Finance and Islamic Bonds (Sukuk) Market.....	114
X. Next Step: Future Direction.....	115
A. Future Direction.....	115
B. Group of Thirty Compliance.....	116
C. Group of Experts Final Report: Summary of Market Barriers Assessment – Japan (April 2010).....	117
XI. Examples of the Recommended Expression (RE) of Related Translations.....	118
References.....	123

Boxes, Figures, and Table

Boxes

Box 1.1	Extract from Financial Services Agency on the Development of Markets for Specified (Professional) Investors).....	24
Box 1.2	Japan Securities Dealers Association Regulations for Bond Transactions.....	31

Figures

Figure 1.1	Monthly Issuance of Corporate (Non-public) Sector Bonds, January 2000–August 2011 (¥ billion).....	14
Figure 1.2	Introduction of Regulation for CRAs (I).....	16
Figure 1.3	Introduction of Regulation for CRAs (II).....	17
Figure 1.3a	Guidelines for Supervision of Credit Rating Agencies (Summary).....	18
Figure 1.3b	Guidelines for Supervision of Credit Rating Agencies (Reference).....	19
Figure 3.1	Trading Volume of Bonds (¥ trillion).....	41
Figure 3.2	Decrease in Bank Loan and Increase in Bank Deposit (December 1999–October 2011).....	42
Figure 3.3	Outstanding of Bond Transactions with Repurchase Agreements, January 2001 to September 2011 (¥ trillion).....	49
Figure 4.1	Bond Market Infrastructure Diagram.....	56
Figure 4.2	Business Process Flowchart: Japanese Government Bond Market/Delivery versus Payment with Matching and Central Counterparty.....	57
Figure 4.3	OTC Bond Transaction Flow for Foreign Investors.....	58
Figure 5.1	Securities Market Infrastructure in Japan.....	60
Figure 5.2	Japan Securities Depository Center, Inc. Book-Entry Transfer System for Corporate Bonds.....	62
Figure 5.3	The Delivery-versus-Payment Mechanism.....	63
Figure 6.1	Semi-Annual Issuing Amount of Non-Public Sector Bonds, January 2000–June 2011 (¥ billion).....	72

Figure 8.1	Issuance of Bonds by Type, FY 1990 to FY 2010 (¥ trillion)	96
Figure 8.2	Outstanding Amount of Bonds (¥ trillion)	98
Figure 8.3	Outstanding Amount of Bonds (Percentage)	98
Figure 9.1	Issuance Scheme.....	110
Figure 9.2	New Taxation Measures	113

Tables

Table 1.1	Change in Number and Value of Securitized Product Issuance Market.....	7
Table 1.2	Methods of Japanese Government Bonds Issuance.....	9
Table 3.1	Trends in Bond Transactions by Type of Transaction Parties (¥ billion).....	43
Table 3.2	Bond Lending Balance as of 30 September 2011 (¥ trillion).....	52
Table 6.1	Semi-Annual Issuing Amount of Non-Public Sector Bonds (¥ billion)	72
Table 6.2	History of the Foreign-Exchange Policy Change and Liberalization of the Yen	86
Table 7.1	Standard Underwriting Fees Schedule for Public Offering Bonds	90
Table 7.2	Short-Term Corporate Bonds-Participation in the System	90
Table 7.3	Short-Term Corporate Bonds-Book-Entry Transfer Businesses.....	91
Table 7.4	Corporate Bonds-Participation in the System.....	92
Table 7.5	Corporate Bonds-Book-Entry Transfer Businesses	93
Table 7.6	Standard Fee Rate for Fiscal Agent and/or Paying Agent	95
Table 7.7	Standard Fiscal Agent Fee for Public Offering of Corporate Bond	95
Table 7.8	Other Fees and Costs	95
Table 8.1	Issuance of Bonds by Type, FY 1990 to FY 2010 (¥ trillion).....	97
Table 8.2	Outstanding Amount of Bonds, FY 1990 to FY 2010 (¥ trillion).....	98
Table 8.3	Size of LCY Bond Market in USD (Local Sources).....	99
Table 8.4	Size of Local Currency Bond Market (Local Sources) (% GDP)	100
Table 8.5	Foreign Currency Bonds (BIS) (\$ billions)	101
Table 8.6	Foreign Currency Bonds to Gross Domestic Product Ratio.....	102
Table 8.7	Foreign Currency Bonds Outstanding (Local Sources) (\$ billions)	103
Table 8.8	Foreign Holdings in LCY Government Bonds (¥ billions)	104
Table 8.9	Domestic Financing Profile	106
Table 8.10	Trading Volume (\$ billions)	106
Table 9.1	Japanese Organizations in the Islamic Financial Services Board.....	108
Table 10.1	Group of Thirty Compliance	116
Table 10.2	Summary of Market Barriers Assessment.....	117

Acknowledgements

The Asian Development Bank (ADB) Team, comprising Satoru Yamadera (Economist, ADB Office of Regional Economic Integration, - September 2011), Seung Jae Lee (Principal Financial Sector Specialist), Shinji Kawai (Senior Financial Sector Specialist [Banking]), Shigehito Inukai (ADB consultant), Taiji Inui (ADB consultant), and Matthias Schmidt (ADB consultant), would like to express their sincere gratitude to national members and expert institutions Ministry of Finance, Bank of Japan, Tokyo Stock Exchange, Tokyo AIM, Inc., Japan Securities Dealers Association, Nomura Securities Co. Ltd., Daiwa Securities Capital Markets, Sumitomo Mitsui Banking Corporation, Mizuho Corporate Bank, Bank of Tokyo-Mitsubishi UFJ, and other support members including NTT Data Corporation and Waseda University. They kindly provided answers to the questionnaires prepared by the ADB Team, thoroughly reviewed the draft of the Market Guide, and gave their valuable comments.

It is also noteworthy to mention that the creation of so-called ASEAN+3 Bond Market Forum-Japan (ABMF-J) group, comprising of the above mentioned members, experts, and other volunteer supporters, is a major achievement (as market associations go, it is an excellent suggestion for other markets) and the effort undertaken and the commitment given by the group was substantial.

The ADB Team also would like to express special thanks to Citibank, Deutsche Bank AG, HongKong Shanghai Banking Corporation (HSBC), J.P. Morgan, and State Street for their contribution as international experts and Japan Securities Research Institute (JSRI) for their contribution to provide information from their respective market guides, as well as their valuable expertise. Because of their cooperation and contribution the ADB Team started the research on solid ground.

Last but not least, the Team would like to thank all the people who gave their comments and responses to questions during the market consultations.

It should be noted that any part of this report does not represent the official views and opinions of any institution which participated in this activity as ABMF members and experts. The ADB Team bears responsibility for the contents of this report.

February 2012

Asian Development Bank (ADB) Team

I. Structure, Type, and Characteristics of the Bond Market

A. Overview

Japan raises significant amounts from capital markets to finance government expenditures, mainly through issues of Japanese government bonds (JGBs) and financing bills, and borrowing. These funding activities are supported by a large and diverse community of domestic and overseas investors and intermediaries.

Japan offers a wide range of financial tools to meet a range of issuer and investor requirements. Aside from traditional instruments such as loans, corporate bonds, and commercial papers, securitized products are also available in Japan's credit market. Securities lending and securities financing businesses are also established. Various credit risks are pooled through these securitized products, with the value of underlying assets exceeding the risks taken by investors.

Among the major market participants in Japan's bond market are domestic and foreign securities companies that serve as dealers, brokers, traders, and underwriters in the primary and secondary markets. The local government, government agency bonds and local public corporation bonds sector are the largest issuer sectors of bonds next to JGBs in the market. Majority of JGB holders are from the public sector, commercial banks, and insurance companies.

The capital market of Japan is supervised by the Financial Services Agency (FSA). Its regulatory purpose is highlighted below. The FSA is the sole regulator for the Japanese financial industry and the domestic financial and capital market. The Securities and Exchange Surveillance Commission is FSA's enforcement arm for the securities market.

Pursuant to the Financial Instruments and Exchange Act (FIEA), the Japan Securities Dealers Association (JSDA) and seven exchanges in Japan are self-regulatory organizations that oversee and inspect day-to-day securities trading.¹ Market

¹ The seven exchanges in Japan are as follows: Fukuoka Stock Exchange (FSE), Nagoya Stock Exchange (NSE), Osaka Securities Exchange (OSE and JASDAQ), Sapporo Stock Exchange (SSE), TOKYO AIM, Inc. (Two market places: TOKYO AIM stock market, TOKYO PRO-Bond Market), and Tokyo Stock Exchange (TSE). Bonds can be listed on TSE and TOKYO PRO-BOND Market.

surveillance is a shared responsibility of the Securities and Exchange Surveillance Commission and self-regulatory organizations. The FIEA is the fundamental law governing domestic capital market and securities and other financial instruments in Japan.

Both foreign and retail investors are allowed to trade bonds in Japan.

The Ministry of Finance (MOF) is responsible for maintaining balance in tenures or interest rates, etc. within the JGB, announcing upcoming JGB issues, and providing relevant tax policies. The Bank of Japan (BOJ) decides and implements monetary policy with the aim of maintaining price stability. In implementing monetary policy, BOJ influences the volume of money and interest rates through its operational instruments, including money market operations such as buying and selling JGBs, for the purpose of currency and monetary control. To contribute to the maintenance of the financial system's stability, BOJ conducts on-site examinations and off-site monitoring, and acts as the lender of last resort to provide liquidity as necessary. BOJ is responsible for the entire operation of Japanese government securities,² including issuance, registration, interest payment, and redemption.

B. Types of Bonds

The term “bonds” generally refers to debt securities issued by governments and other public entities as well as by private companies. The issuance of bonds is a means of direct financing, through which the issuer raises funds, but, unlike equity financing, the issuer has an obligation to repay the principal at maturity.

Bonds are classified into the following categories:³

1. Japanese government bonds: JGB (*koku-sai*, 国債),
2. Local governments bonds (prefectures, municipalities (cities, towns and villages)) (*chiho-sai*, 地方債),
3. Government agency bonds (*seifukankeikikan-sai*, 政府関係機関債)
 - a. Japanese government-guaranteed bond (*seifuhosho-sai*, 政府保証債)
 - b. Fiscal Investment and Loan Program (FILP)-agency bond (*zaitokikan-sai*, 財投機関債)⁴
 - c. Government-affiliated corporation bonds (*hikoubo-tokushu-sai*, 非公募特殊債)
4. Local public corporation bonds (*chihoukousha-sai*, 地方公社債)
5. Local governments agency bond (Japan Finance Organization for Municipalities [JFM] bond) (*chihoukoukyoudantaikinyukikou-sai*, 地方公共団体金融機構債)⁵

² JGS include JGB, Treasury bills (T-bills) and financing bills (FB).

³ Government of Japan. Ministry of Finance. 2011. *Debt Management Report 2011 - The Government Debt Management and the State of Public Debts*. http://www.mof.go.jp/english/jgbs/publication/debt_management_report/2011/

⁴ Use of proceeds are limited to and built into FILP of the Japanese Government approved by the Diet, the Japanese parliament.

⁵ The Japan Finance Organization for Municipalities was founded by all local governments (prefectures, cities, wards, towns, and villages).

6. Corporate bonds (*shasai*, 社債)
 - a. Straight corporate bonds, etc. (*futsu-shasai*, 普通社債等)
 - b. Asset-backed corporate bonds (*shisantanpogata-shasai*, 資産担保型社債)
 - c. Convertible bonds (*tenkan-shasai*, 轉換社債),
7. Bank debentures (*kinyu-sai*, 金融債), and
8. Nonresident bonds (foreign bonds) (*hikyojusha-sai*, 非居住者債)
 - a. Yen-denominated foreign bonds (*endate-gaisai*, 円建て外債; *samurai-sai*, サムライ債)
 - b. Asset-backed foreign bonds (*shisantampogata-hikyojusha-sai*, 資産担保型非居住者債).

Public offering of Corporate bonds, Asset-backed bonds and Non-resident bonds (as classified under 6., 7. and 8. above) are subject to disclosure requirements under the FIEA. All other bonds are exempt from FIEA disclosure requirements.

C. Explanation of the Major Types of Bonds

1. Government bonds

Government bonds are the securities issued by the central government. The central government pays the bondholders interests on the securities and repays the principal amount (i.e., redemption). Interest is payable on a semiannual basis, except for short-term bonds, and the principal amount is redeemed at maturity.

The JGBs currently issued can be classified into five categories:

- a. Short-term bills (6-month and 1-year),
- b. Medium-term notes (2-year and 5-year bonds),
- c. Long-term bonds (10-year bonds) and
- d. Super long-term bonds (20-year, 30-year and 40-year bonds)
- e. JGBs for retail investors (3-year, 5-year and 10-year)

During fiscal year 2002 (ending on 31 March 2003), the government introduced the Separate Trading of Registered Interest and Principal of Securities (STRIPS) and (variable-rate) retail 10-year JGB programs.

The principal and individual interest payment components of JGBs designated by the MOF as “book-entry securities eligible to strip” has been traded as separate zero-coupon government bonds. Subsequently, the government started issuing

- a. 10-year consumer price index (CPI)-linked bonds,
- b. 5-year and three-year bonds for retail investors and
- c. 40-year fixed-rate bonds in fiscal years 2003, 2005, and 2007, respectively.

The short-term JGBs are all discount bonds, meaning that they are issued at the price lower than the face value. No interest payments are made, but at maturity the principal

amounts are redeemed at face value.⁶ On the other hand, all medium-, long- and super long-term bonds, and JGBs for retail investors (3-year, 5-year) are bonds with fixed-rate coupons. With fixed-rate coupon-bearing bonds, the interest calculated by the coupon rate determined at the time of issuance is paid on a semiannual basis until the security matures and the principal is redeemed at face value. JGBs for retail investors (10-year floating rate) are JGBs with coupon rates that vary over time according to certain rules. The 15-year floating-rate bonds, as well as the JGBs for retail investors (10-year) feature their coupon rates that vary according to certain rules. New issuance has been put on hold for the 15-year floating-rate bonds, however.

Issuance has also been put on hold for inflation-indexed bonds, which are securities whose principal amounts are linked to the CPI as stated above. Thus, although their coupon rates are fixed, the interest payment also fluctuates.

2. Local Governments Bonds

Local governments and municipalities borrow funds on deeds from banks or issue debt securities in the market. Sometimes, they are called municipal debt. Those issued in the bond market are generally called “local governments bonds”. Of these, those securities that are placed with an unspecified number of investors are called “publicly offered municipal bonds.” These bonds are issued as a single entity, but some bonds are issued as a joint issue with several local governments. While those placed privately with local banks and other financial institutions are called “privately placed municipal bonds.”

3. Government Agency Bonds

Government agency bonds are debt securities issued by various government-affiliated entities, such as incorporated administrative agencies.

Agency bonds are divided into:

1. Government-guaranteed bonds that are backed by the full faith and credit of the government,
2. FILP-agency bonds that are issued by fiscal investment and loan agencies that do not enjoy such guarantee, and
3. Government-affiliated corporation bonds

The three categories of debt securities mentioned above are sometimes collectively called “public sector bonds.”

4. Corporate Bonds

In addition to non-financial enterprises, banks and consumer finance companies may also issue corporate bonds in accordance with the *Companies Act*.

5. Bank Debentures

Bank debentures are debt securities issued by certain banking institutions under special laws and play a fund-raising role as an alternative to deposits. They are

⁶ Since February 2009, Treasury bills (6-month, 1-year) and financing bills (2-Month, 3-Month, 6-Month) have jointly been issued, under unified names of Treasury Discount Bills (abbreviation: T-Bill), in the primary and secondary market transaction. But their legal status has not changed under the existing fiscal system and they will continue to be handled as Treasury Bills and Financing Bills under the fiscal system.

principally issued in the form and maturities of 5-year interest-bearing and 1-year discounted debentures.

6. Non-Resident Bonds (Foreign Bonds)

Foreign bonds are defined as debt securities issued in Japan by non-Japanese resident issuers. Those denominated in yen, in particular, are separately classified as yen-denominated foreign bonds, or Samurai bonds.

D. Securitized Products Market

1. Securitized Products

The income-generating assets of a company are pooled separately from its balance sheet into a special-purpose vehicle (SPV), and the SPV issues a security backed by the cash flow to be generated by such assets and sells the security to investors. This method is called “securitization.” The security issued through such a process is generally called a “securitized product.”

Business enterprises use their assets—such as auto loans, mortgage loans, leases receivable, business loans, and commercial real estate—as collateral to back up their securitized products.

As defined by the *Asset Securitization Act*, intellectual property (such as copyrights and patents) also can be securitized.

2. Basic Mechanism of Issuing Securitized Products

Generally, many of the securitized products are issued through the mechanism described below.

First, the holder of assets (“originator”) such as mortgage loans and accounts receivable that are to be securitized assigns them to an SPV. By doing so, such assets are separated from the balance sheet of the originator and become assets of the SPV, which becomes the holder of the assets. An SPV may take the form of a partnership, a trust, or a special-purpose company (SPC), and most SPVs take the form of an SPC.

An SPC established under the *Asset Securitization Act* (revised as the *Special-Purpose Company [SPC] Law*) (2000年改正SPC法 or 資産流動化法) is called *tokutei mokuteki kaisha* (特定目的会社: TMK, or a specific-purpose company).

The next step is to formulate the terms of issue of the securitized product to be issued by the SPV. If the originator opts for the trust method, it issues beneficiary certificates like those of a trust company. If it chooses the SPC method, it issues the kinds of securities decided upon by the SPC, but it does not have to issue them on one and the same terms of issue. In short, it can design each type (tranche) of security with a different character by differentiating the order of priority with respect to the payment of interest and redemption of principal, by varying maturities, or by offering the guarantee of a property or casualty insurance company. By adding such variation, the originator can issue securities that meet the diverse needs of investors. In the order of priority for payment, such securities are called “senior securities,” “mezzanine securities,” or “subordinated securities.”

When the originator plans to sell its securitized products to an unspecified large number of investors, it should make them readily acceptable to investors by offering them objective and simple indicators (credit ratings) for independently measuring the risks involved. In addition, there are other players involved in different processes of securitized products, such as servicers, who manage assets that have been assigned to an SPV and securitized, and also recover funds under commission from the SPV and bond management companies, which administer the securitized products (corporate bonds) purchased by investors. Firms that propose such a mechanism for securitizing assets and that coordinate the issuing and the sale of such products are called “arrangers,” and securities companies and banks often act as arrangers.

3. Description of Major Securitized Products

Securitized products are divided into several groups according to the types of assets offered as collateral and the character of the securities issued. Those belonging to the group of products that are backed by real estate and the claims collateralized by it are residential mortgage-backed securities (RMBS), commercial mortgage-backed securities (CMBS), and real estate investment trusts (J-REIT) which are categorized in equity.

RMBSs are issued in retail denominations against a portfolio that pools home mortgage loans. The first securitized product based on residential mortgage loans was the Residential Mortgage Loan Trust (住宅ローン債権信託) launched in 1973, for the purpose of handling the liquidation of mortgage loans of mortgage companies. However, this product failed to attract the attention of both issuers and investors because of too many limitations. This scheme had been regulated by the MOF and has been fully liberalized in June 1998. As the scheme based on SPC became available thereafter, as a result of the enactment of the former SPC Law in 1998 (1998旧SPC法 or 特定目的会社による特定資産の流動化に関する法律), the volume of this type of issue has increased since 1999.

Although bonds backed by housing loans that have been issued by the Japan Housing Finance Agency since 2001 were not issued through an SPC, they may be included among the RMBSs.

CMBSs are backed by loans given against the collateral of commercial real estate (office buildings, etc.). The mechanism of issuing them is almost the same as that for RMBSs.

This is not a bond but as a reference, J-REIT, which became available by virtue of implementation of the *Investment Trust and Investment Corporation Law* (投資信託及び投資法人に関する法律) in May 2000, is an investment trust in that it can only invest real estate and loans backed by real estate.

Another group consists of securities backed by assets (asset-backed securities [ABS], narrowly defined), such as accounts receivable, leases receivable, credits, auto loans, and consumer loans, etc. Sales of these products began to increase following the enactment of the *Specified Claims Law* (特債法 or 特定債権法) in June 1993.

Other securitized products are called “collateralized debt obligations” (CDO), which are securities issued against the collateral of general loans, corporate bonds, credit

risks of loans that are held by banking institutions. For instance, loans to small and medium-sized business enterprises that are securitized may be considered CDOs. CDOs are subdivided into collateralized loan obligations (CLO) and collateralized bond obligations (CBO). Moreover, since the eligibility requirements for issuing commercial paper (CP) were abolished in 1996, an increasing number of business corporations have come to use asset-backed commercial paper (ABCP).

4. Issuing Market for Securitized Products

As the bulk of securitized products are issued in private placement transactions between the parties concerned, it is difficult to accurately grasp the size of their market. To remedy this shortcoming, underwriters that are involved in the transactions and credit rating agencies have been tracking the market on their own.

According to JSDA and Japan Bankers Association, the total value of securitized products issued in Japan was about ¥2.6 trillion in 2010. Although securitized products issuance reached a peak of ¥9.8 trillion in 2006, levels have declined sharply over the past few years under the impact of the weakening of the economy kicked off by the subprime loan problem.

Table 1.1 Change in Number and Value of Securitized Product Issuance Market

	2004	2005	2006	2007	2008	2009	2010
Number of Issuance of Securitized product	296	312	314	261	204	146	107
Issuing amount of Securitized products	¥5.3 trillion	¥8.2 trillion	¥9.8 trillion	¥6.8 trillion	¥3.7 trillion	¥2.9 trillion	¥2.6 trillion
[Reference]							
Issuing amount of corporate bonds	¥5.9 trillion	¥6.9 trillion	¥6.8 trillion	¥9.4 trillion	¥9.6 trillion	¥10.3 trillion	¥9.9 trillion
Source:	JSDA and Japan Bankers Association.						

5. Secondary Market for Securitized Products

With the exception of beneficiary certificates of J-REIT, trading in securitized products is not conducted in stock exchanges. This is because, as is the case with bonds, securitized products and their transactions are too complex and varied to lend themselves to exchange trading. This has led to the dependence on an over-the-counter (OTC) interdealer market for their trading.

6. The Enactment of Securitization-Related Laws

The existing legal system of Japan is built around business-specific laws, and the regulatory system of financial products is vertically divided along the lines of business-specific laws. As these laws contain many provisions regulating or banning business activities outright, it was pointed out that to spur the development of new business, such as the securitization of assets, the existing laws have to be amended, and new laws must be enacted.

As regards the securitization of assets, the *Specified Claims Law* was enacted as an independent law (特債法 or 特定債権法) in 1993. Since the enforcement of this law, the legal infrastructure has been developed steadily. Under the *Specified Claims Law*, the liquidation and securitization of assets classified as specified claims, such

as leases receivable and credit card receivables, started. Thereafter, various laws were enacted to help the banking institutions meet the capital ratio requirements imposed by the Bank for International Settlements (BIS) and to encourage the securitization of their assets to deal with the bad loan problem that had become serious since the turn of the decade of the 1990s.

Under the SPC Law in 1998 and *Asset Securitization Act* enacted as the revised SPC Law in 2000, structures incorporating SPVs, including specific-purpose companies (TMK) and specific-purpose trusts (SPT), may be used for securitizing specified assets designated in the provisions of the said laws (real estate, designated money claims, and beneficiary certificates issued against such assets in trust) in the form of ABSs (such as senior subscription certificates, specified corporate bonds, and specified promissory notes, etc.). Under the SPC Law, the system of disclosing an asset liquidation plan and individual liquidation projects was introduced, in addition to the disclosure requirements of the *Securities and Exchange Law* (the FIEA now).

In 1998 the *Perfection Law* (債権譲渡特例法) was enacted as a law prescribing exceptions to requirements under the *Civil Code* (民法) for the perfection of the assignment of receivables and other properties, and it was amended in 2005. The *Civil Code* provides the legal requirements for the assertion of the assignment of nominative claims (claims with named creditors) against obligors or third parties. Designated claims were transferable, but the provisions of the *Civil Code* had been a major hurdle in securitizing them. The *Perfection Law* set forth simple procedures for the perfection of such interests.

The *Servicer Law*, enacted to account for exceptions to the provisions of the *Practicing Attorney Law* (弁護士法), allows accredited joint stock companies to provide the services of administering and collecting debts. Under the *Servicer Law* (サービス法 or 債権管理回収業に関する特別措置法), a debt collection company may be established to provide a bad debt collection service without conflicts with the *Practicing Attorney Law*.

By amending the *Equity Contribution Law* (出資法), the *Nonbank Bond Law* (ノンバンク社債法) conditionally lifted the ban imposed on nonbanks on the issuance of corporate bonds and CPs for the purpose of raising capital for lending operations and on ABSs.

As a result of the revision of the *Securities and Exchange Law* (証券取引法) as required by the *Financial System Reform Law* (金融システム改革法) and the enforcement of the FIEA (金融商品取引法), beneficiary certificates of and trust beneficiary interests in assets that are deemed eligible for securitization by the provisions of the *Asset Securitization Act* (改正SPC法 or 資産流動化法) and mortgage certificates under the *Mortgage Securities Law* (抵当証券法) are now legally considered securities.

Furthermore, pursuant to the enactment of the *Investment Trust Law* (投資信託法) as revised, real estate was included in eligible assets, which paved the way for the issuance of J-REIT securities.

E. Methods of Issuing Bonds Other than Corporate Bonds

1 Government Bonds

JGBs and other government debt securities are mainly issued as either underwritten by primary dealers (PDs, so-called participants) and re-sold to the public market or direct subscription by BOJ and other government-affiliated parties. Major volume of JGB issuance and distribution are sustained by PDs, while BOJ underwriting has given assurance of balance of supply and demand in the JGB market.

a. Methods of Japanese Government Bonds Issuance

Methods of JGB issuance are broadly categorized into “issuance to the market,” “issuance to retail investors,” and “issuance to the public sector”.

Table 1.2 Methods of Japanese Government Bonds Issuance

Methods of JGB Issuance	Explanation
A. Offering to the market	JGBs are principally issued in public offering on market-based terms of issuance.
a. Price/yield-competitive auction	<p>Price/yield-competitive auction is a method in which each auction participant submits a bidding price (or yield) and bidding amount in response to the issue terms (e.g., issue amount, maturity, coupon rate) presented by the MOF, and the issue price and amount will then be determined based on the bids.</p> <p>In this type of auction, the issuing authority starts selling first to the highest price bidder in descending order (or to the lowest yield bidder in ascending order) till the cumulative total reaches the planned issue amount.</p> <p>In Japan, the auction method varies by type of security.</p> <p>One is the conventional method by which each winning bidder purchases the security at his bidding price; and the other is the Dutch-style method by which all winning bidders pay the same lowest price of their biddings regardless of their original bid (Except for inflation-indexed bonds and 40-years bonds, offered via Dutch-style yield-competitive auction, all the JGBs are offered via the conventional price competitive auction).</p> <p>In order to increase government bond liquidity, the MOF also started implementing the immediate reopening rule effective from March 2001 issues. When a new issue is offered by the MOF, both its coupon rate and principal or interest payment dates may occasionally correspond to those of a specific issue outstanding. In such a case, the MOF reopens the outstanding issue additionally. And then, as soon as it comes into the market, the reopened issue is immediately dealt as the outstanding issue based on the immediate reopening rule.</p> <p>Also, under the new rule, a reopened issue will generate accrued interest (a 6-month interest will be paid in full to bondholders at the first interest payment even when the bondholding period during the purchase to the first interest payment will amount to less than 6 months. To make the necessary adjustment, bondholders are required to pay accrued interest at the time of purchase (i.e., the interest for the period calculated by subtracting the actual bondholding period from 6 months).</p> <p>Furthermore, in April 2006, Auctions for Enhanced-Liquidity (See b. below), in which the outstanding issues with scarce liquidity are additionally reopened, were introduced to maintain and enhance the liquidity of the secondary market.</p>
b. Non-competitive auction	<p>Besides competitive auction, 2-year, 5-year and 10-year Bonds are also issued through non-competitive auction. This approach is to take into account small and medium market participants who tend to submit a smaller bid than their larger counterparts.</p> <p>Biddings for non-competitive auction are offered at the same time as for the price-competitive auction, and the price offered equals to the weighted average accepted price of the price competitive auction.</p> <p>One can bid for either the price competitive auction or for the non-price competitive auction.</p> <p>The maximum issue amount is 10% of the planned issue amount.</p> <p>Each participant is permitted to bid up to ¥1 billion.</p>
c. Non-Price Competitive Auction I and II	<p>Non-Price Competitive Auction I is an auction in which biddings are offered at the same time as for the price-competitive auction. The maximum issuance amount is set at 10% of the total planned issue amount and the price offered is equal to the weighted average accepted price of the price competitive auction. Only the JGB Market Special Participants are eligible to bid in this auction. Each participant is allowed to bid up to the amount set based on the result of its successful bids during the preceding two quarters.</p> <p>Non-Price Competitive Auction II is an auction carried out after the competitive auction is finished. The price offered is equal to the weighted average accepted price in the price-competitive auction or lowest accepted price in Dutch-style yield-competitive auction. Only the JGB Market Special Participants are eligible to bid in this auction. Each participant is allowed to bid up to the 15% of one's total successful biddings in the competitive auction and Non-Price Competitive Auction I.</p>

continued on next page

Table 1.2 continuation

Methods of JGB Issuance	Explanation
	JGB are offered through above b. and c. reserved for special participants (PDS) (23 companies are designated as of October 2009).
B. Methods of selling JGBs to Retail Investors	
a. JGBs for Retail Investor	In March 2003, issuance was started on 10-year floating-rate bonds for Retail Investors in order to promote JGB ownership among individuals. Moreover, in order to respond to retail investors' different needs and to further promote sales, fixed rate 5-year and 3-year JGBs for Retail Investors were introduced. Bond features have been undergoing various improvements, again for additional sales promotion. Issuance of JGBs for Retail Investors rests on their handling and distribution during the specified application period by their handling institutions comprised of security companies, banks, and other financial institutions, as well as post offices (as of 7 March 2011, handling institutions numbered 1,102). Under this arrangement, the handling institutions are commissioned by the state to accept purchase applications and to sell JGBs to retail investors. Handling institutions are paid a commission by the state corresponding to the handled issuance amounts
b. New Over-The-Counter (OTC) sales system for selling marketable JGBs	In addition to JGBs for Retail Investors, in October 2007 a new OTC sales system for marketable JGBs was introduced in order to increase retail investor purchase opportunities with regard to JGBs (2-year, 5-year, and 10-year marketable bonds). With regard to this new OTC sales system, it allows private financial institutions to engage in subscription-based OTC sales of JGBs in a manner previously exclusive to post offices. This development allows retail investors to purchase JGBs via financial institutions with whom they are familiar, it also allows them to purchase JGBs in a manner that is essentially ongoing. As with JGBs for Retail Investors, for the new OTC sales system, the MOF has commissioned financial institutions (as of 1 March 2011, 755 institutions are conducting subscription-based sales of JGBs) to conduct subscriptions and sales of JGBs. the MOF pays subscription handling charges to these institutions based on the value (volume) of subscriptions handled by them. Note that while these financial institutions are required to subscribe and sell JGBs at prices defined by the MOF within a defined period, they are not required to purchase any unsold JGBs.

Source: Japan, Ministry of Finance website.

b. Auctions for Enhanced-Liquidity

The amount of auctions for enhanced-liquidity has been expanded in keeping with the striking drop in JGB market liquidity after the Lehman Shock in 2008 and the alteration of JGB Issuance Plan according to budget formulation. Specifically, the frequency of auctions was increased from the conventional one per month to two per month in October 2008, and the issuance per auction was raised in stages from ¥100 billion to ¥300 billion by July 2009. On these approaches, a discussion paper entitled “Current Situation and Future Challenges of Debt Management Policy–Discussion Paper” compiled by the Advisory Council on Government Debt Management (16 December 2009) (hereinafter referred to as the “Discussion Paper”), suggests that “the issuing authorities should identify the auctions as a supplementary measures” [sic] and that “it is desirable for the issuing authorities to consider the issuance size, frequency and target issues, upon sharing such recognition with market participants that the auction should be implemented within the supplementary function.”⁷

As with Fiscal Year (FY) 2010, the JGB Issuance Plan for FY2011 stipulates an issuance of ¥600 billion monthly (total amount in FY2011 is ¥7.2 trillion annually). For the first quarter of FY2011, it was described after discussions at the meeting of JGB market special participants and the meeting of JGB investors to continue monthly issuance in the amount of ¥300 billion for each of the 10- and 20-year bonds with 5 to 15 years remaining until maturity, and of the 20- and 30-year bonds with 15 to 29 years remaining until maturity.

⁷ Government of Japan. Advisory Council on Government Debt Management. 2009. *Current Situation and Future Challenges of Debt Management Policy–Discussion Paper*. http://warp.ndl.go.jp/info:ndljp/pid/1022127/www.mof.go.jp/english/bonds/discussion_paper.pdf

c. Japanese Government Bonds Market Special Participants Scheme

Amid expectations that JGB issuance in large volumes will continue, in October 2004 the “JGB Market Special Participants Scheme” was introduced in Japan. This scheme is based on the so-called “Primary Dealer System” generally maintained in major European countries and the United States (U.S.) to facilitate secure stable consumption and to maintain and enhance the liquidity of government bond markets.⁸ Under the scheme, the MOF grants special entitlements to certain auction participants when they carry out responsibilities essential to debt management policies. The following is an outline of the scheme:

i. Purpose

To promote stable financing and to maintain and improve liquidity on the JGB market, the MOF cooperates with JGB market special participants, who are key players in the JGB market and participate in planning and operating JGB management policies with special entitlements and responsibilities.

ii. History of Introduction of Systems

- 1) October 2004: The JGB Market Special Participants System was introduced and Special Participants were designated. The Meeting of Special Participants was also started. The Non-Price Competitive Auction II (held concurrently after normal competitive auctions) was launched.
- 2) April 2005: The Non-Price Competitive Auction I (held concurrently after normal competitive auctions) was launched.
- 3) January 2006: Interest rate swap transactions started.
- 4) March 2006: The government bond syndicate underwriting system was abolished.
- 5) April 2006: Auction for Enhanced-Liquidity was launched.

d. Current Japanese Government Bonds Issuing Market Situation

JGB market issuance (JGBs issued through scheduled auctions from April to next March) increased by ¥0.6 trillion from FY2010 initial plan up to ¥144.9 trillion. This issuance amount increased for the third consecutive year.

JGBs issued to retail investors widely fluctuated depending on the trend of interest rate. Therefore, in the FY2011 issuance plan, considering the past sales amount, as well as revisions of the rate-setting formula for 10-year floating-rate in July 2011, issuance of JGBs to retail investors amounted ¥2.5 trillion.

JGB issuance to the public sector, while JGB issuance is made only to the BOJ, increased by ¥0.5 trillion from the FY2010 initial plan to ¥11.8 trillion.

In FY2011, with market issuance plan by JGB types reaching the historic highest of ¥144.9 trillion, the issuance covers a wide range of maturities from the short-term to the super long-term zones to eliminate distortive impacts on the market to the extent possible while taking into consideration the market trends and investor needs.

To ensure the basic objective of Debt Management Policy, stable and smooth issuance

⁸ For details, refer to II. Framework of Debt Management. http://www.mof.go.jp/english/jgbs/publication/debt_management_report/2011/saimu2-1-1.pdf

of JGBs, and minimize medium-to-long term funding cost, the issuing authorities are very much interested on whether the JGB market has sufficient liquidity to enable transactions to be conducted freely in accordance with investors' interest rate forecasts and investment strategies.

The JGB secondary market consists of brokers such as JGB market special participants (PDs) and investors. Basically, the maintenance and enhancement of liquidity should be achieved by autonomous functioning of the market, which is stimulated by active transactions among such market participants. Consequently, issuing authorities should support this autonomous functioning by arranging amounts and maturities, as well as reopen issues in the primary market.

However, the JGB market may also see a rapid fall in liquidity in times of global financial market turmoil such as that following the September 2008 Lehman Shock. In such circumstance, issuing authorities have flexibly executed auctions for enhanced-liquidity and buy-backs and measures utilized previously, and have pursued steady and smooth issuance of JGBs while providing liquidity support to the JGB market.

In the near term, amid prospects of continued JGB issuance in large volumes, to maintain the liquidity of JGB markets remains a critically important point. While a basic stance lies on the autonomous function of the market, the issuing authority views that the use of supplemental means is effective given it remains within the scope required for attaining the basic targets of JGB management policy.

2. Local Government Bonds

Local government bonds include prefecture bonds and municipalities (city, town, and village) bonds. Under local finance law, the concept of local government bonds exclude less than 1 year finance, and includes not only bonds but also loans. To avoid complication, hereafter loans are excluded from the definition of local government bond.

The *Local Autonomy Law* authorizes Japanese local governments—prefectures, municipalities (cities, towns and villages), Tokyo's special wards, and local government cooperatives—to borrow money provided that the following conditions are fulfilled:

- a. A local public body must prepare a budget plan that defines the use of proceeds from the proposed bond issue and obtain the approval of the local assembly.
- b. The actual issuance for a prefecture and a designated city is also subject to consultation with the Minister of Internal Affairs and Communications (MIC), and issuance for an ordinary city, town and village is subject to consultation with the governor of the prefecture concerned (local bond consultation system).
- c. Use of proceeds is confined to what local finance law determines.

So far, 30 prefectures and 19 designated cities have issued local government bonds through public offerings.

Local government bonds issuance terms are determined based on negotiations between the issuer and the underwriting syndicate. They take into account a broad

range of factors, including trading conditions, spreads over JGBs, and trends in the overall bond market.

There are also joint local government bonds which are issued in the form of public offerings each month by 33 local governments under joint and several guarantees.

3. Government Agency Bonds

a. Government-Guaranteed Bonds

The issuance of government-guaranteed bonds is part of the FILP, and annual ceilings on the issue amount must be approved by the Diet. All government-guaranteed bonds are issued in the form of interest-bearing bonds with maturities ranging from 2 to 30 years. Government-guaranteed bonds are issued by way of either (1) negotiated underwriting by a so-called national syndicate or (2) Dutch auction. In the former method, the terms of issue are determined based on the average of pre-marketing results of all national syndicate members; in the latter, the terms are set through competitive bidding.

b. Fiscal Investment and Loan Program-Agency Bonds

FILP-agency bonds are also issued as interest-bearing bonds with maturities ranging from 5 to 10 years. In issuing them, the issuing agency usually selects a lead manager, which, in turn, forms an underwriting syndicate.⁹

F. Methods of issuing Corporate Bonds

The issuance of corporate bonds had long been subject to strict regulation. However, the *Commercial Code* was amended in 1993 to drastically change the system, and the regulations on the issuance of corporate bonds have been substantially eased.

In the case of public offering of corporate bonds, the issuing corporation (issuer) first appoints a lead manager and other underwriters that together constitute an underwriting syndicate, a commissioned company for bondholders (see §1.09) or a fiscal agent (FA), and providers of other relevant services and at the same time applies for a credit rating. Under normal circumstances lead manager(s) go ahead with price discovery followed by a book-building process by all syndicate members. The issue terms of the bonds are finalized first thing in the morning on the pricing date based upon the book that had been closed prior to the pricing. Then, the subscription starts immediately after final terms and conditions are electronically filed with the Local Finance Bureau of the MOF of Japan. Subsequently, payment for the bonds is made, and the issuance of the corporate bonds is completed.

As for price talk and pricing, more recently, an increasing number of issuers employ “spread pricing,” a method under which the investors’ demand is measured in terms of a spread over JGB yield or over Libor rate. Top tier issuers are priced based upon JGB yield.

⁹ Japan Securities Research Institute. 2010. *Securities Market in Japan 2010*. Tokyo, Japan. P.86–88. <http://www.jsri.or.jp/web/publish/market/index.html>

Since 2000, a new practice known as “Internet-based bond issue”—a series of new issue procedures covering price discovery, book building and pricing carried out through the Internet—has been prevailing.

Discounted bank debentures are issued twice a month by an issue-as-reverse inquiry. Discounted bank debentures are issued by banking institutions, such as Aozora Bank (mainly former Long-term Credit Bank-related banks). Those banks are commissioning securities companies to sell them on their behalf.

Meanwhile, interest-bearing bank debentures are issued in two ways: issuing debentures through a public offering on a fixed day and selling them during a certain selling period.¹⁰

G. Credit-Rating Agencies and Credit Rating of Bonds

Credit rating was introduced in Japan in the 1980s, and it has become general practice in issuing of and investing in corporate bonds. In Japan, bonds with a credit rating of BB, B, CCC, CC, or C, which are called “junk bonds” or “high-yield bonds,” did not exist in the primary market because of a policy that excluded bonds that did not meet the eligibility standards established by the market participants. However, today there are no more such regulations because eligibility standards were abolished in 1996. Nevertheless, few BBB-rated bonds, let alone junk bonds, have been offered on the market.

Figure 1.1 Monthly Issuance of Corporate (Non-public) Sector Bonds, January 2000–August 2011 (¥ billion)

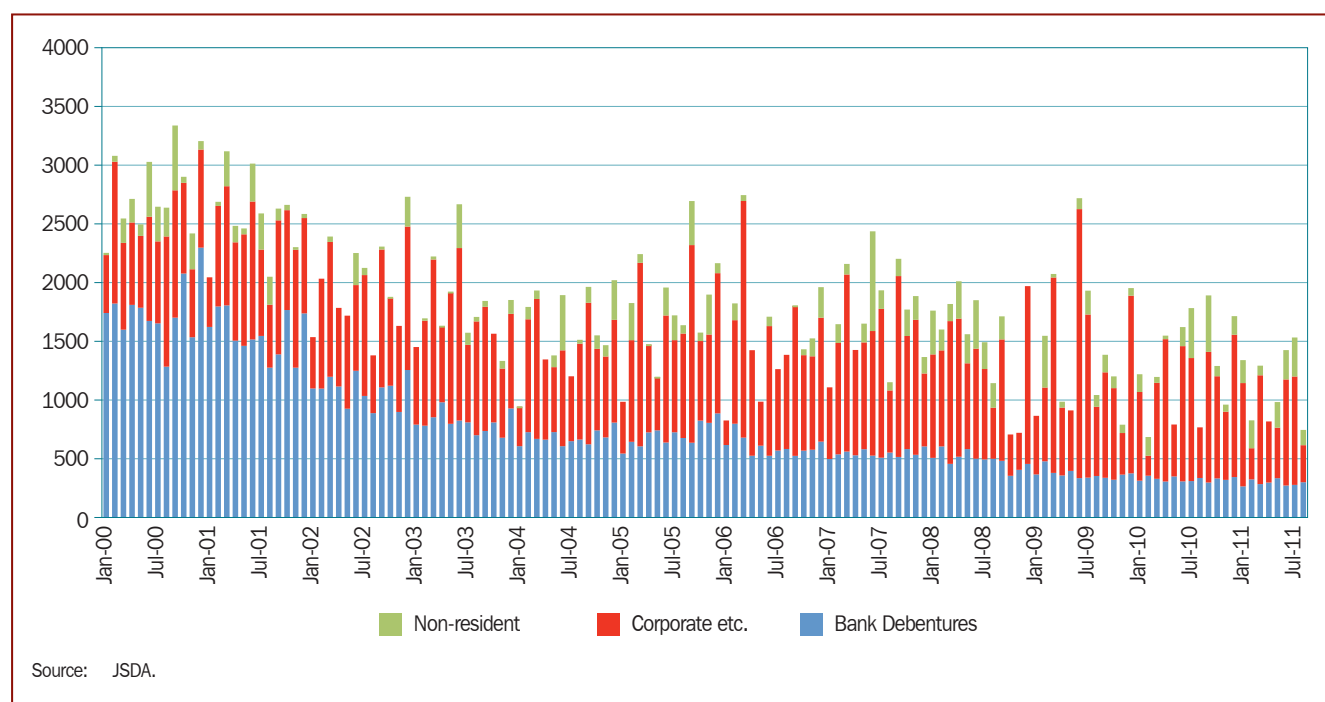

¹⁰ Footnote 9, p.88–91.

After the latest financial crisis of 2007–2008, the gradual recovery trend in corporate performances and demand from financial institutions in Japan, particularly regional financial institutions, supported a gradual recovery in the second half of 2008 and the beginning of 2009 in demand for corporate bonds with credit ratings of A or higher. However, with the exception of bonds with relatively stable earnings, such as railway companies, bonds with low credit ratings have not received the same positive treatment in Japan, despite the reverse trend in Europe and the U.S., and their issuance remains at low ebb.

One explanation is that backed by the prudential regulations and internal investment guidelines, most of the institutional investors in Japan are risk averse and do not invest their funds in assets other than those with a credit rating of A or higher. Designated rating agencies now include both domestic representatives, such as the Rating and Investment Information (R&I) and the Japan Credit Rating Agency (JCR), and global agencies, such as Standard & Poor's, Moody's and Fitch. In the middle of 2000s, they expanded their range of activities to credit ratings of municipal and FILP agency bonds.¹¹

H. Introduction of the Register System for Credit-Rating Agencies in Japan

1. New Regulation System

After sub-prime loan crisis, there were huge controversies about regulation of the credit-rating agencies (CRAs). In Japan, the regulations for CRAs were introduced on 1 April 2010. Along with the new regulation system, six CRAs registered with FSA on 17 December 2010. The following are the registered CRAs in Japan:

- a. Japan Credit Rating Agency, Ltd.,
- b. Moody's Japan K.K.,
- c. Moody's SF Japan K.K.,
- d. Standard & Poor's Ratings Japan K.K.,
- e. Rating and Investment Information, Inc., and
- f. Fitch Ratings Japan Limited.

2. Financial Instruments Business Operators' Obligation

Since October 2010, in soliciting customers, financial instruments business operators shall not use the credit ratings provided by unregistered CRAs, without informing customers of (a) the fact that those CRAs are not registered and (b) the significance and limitations of credit ratings.

3. Partial Amendment to Prospectus Form

As of January 2011, bond issuers, when they solicit credit ratings from a registered CRA for a public offering, must disclose the outcome of such credit ratings and explain assumptions and limitations of credit ratings, in their prospectus.

4. Related Laws and Regulations

- a. *Financial Instruments and Exchange Act*

¹¹ Footnote 9, p. 91–93

- b. Cabinet Ordinance on Financial Instruments Business
- c. Cabinet Ordinance on Disclosure of Corporate Information
- d. Cabinet Ordinance on Definitions under Art. 2 of the FIEA

5. Overview of Regulations and Guidelines for Credit-Rating Agencies

- a. Introduction of Regulation for CRAs

Figure 1.2 Introduction of Regulation for CRAs (I)

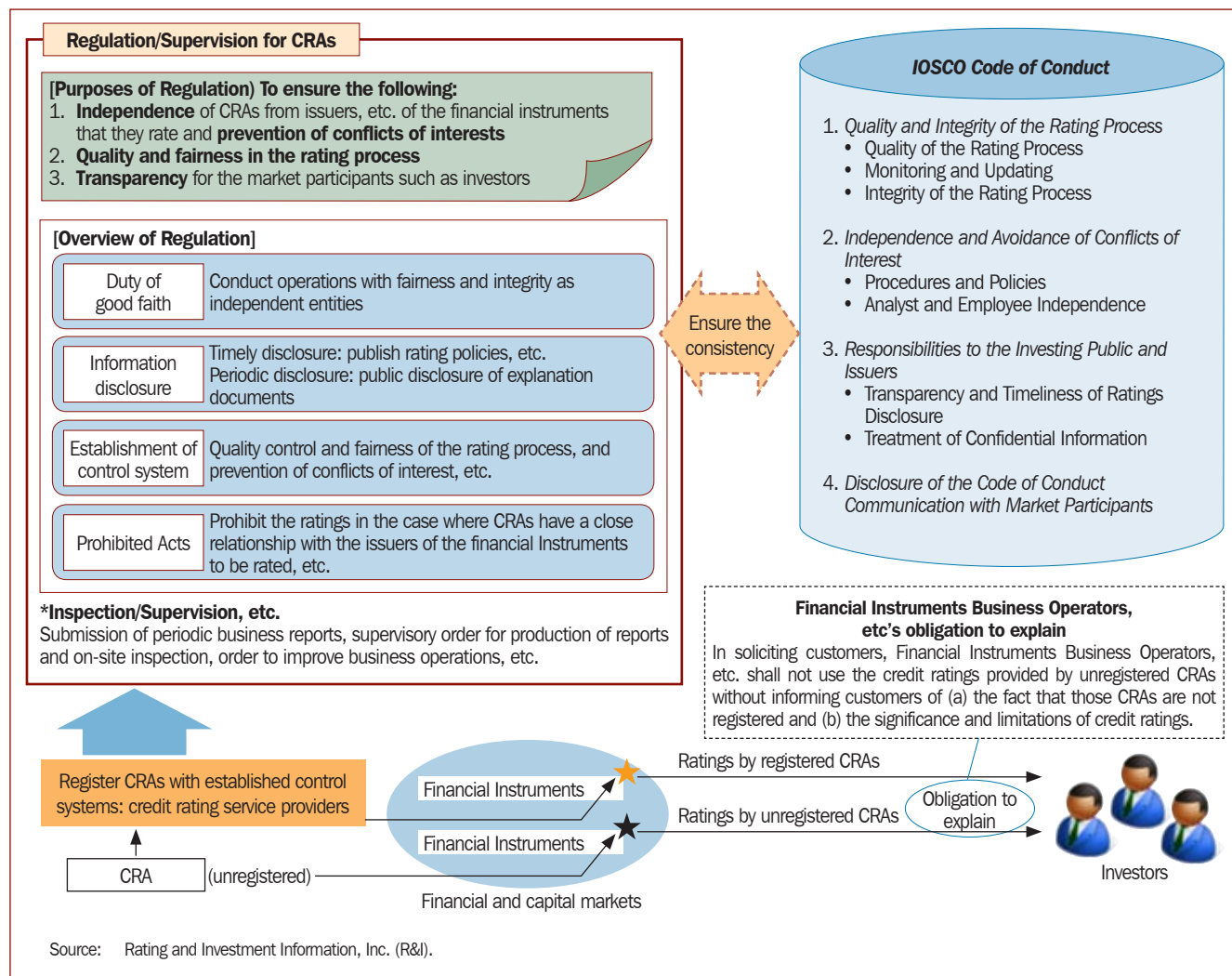
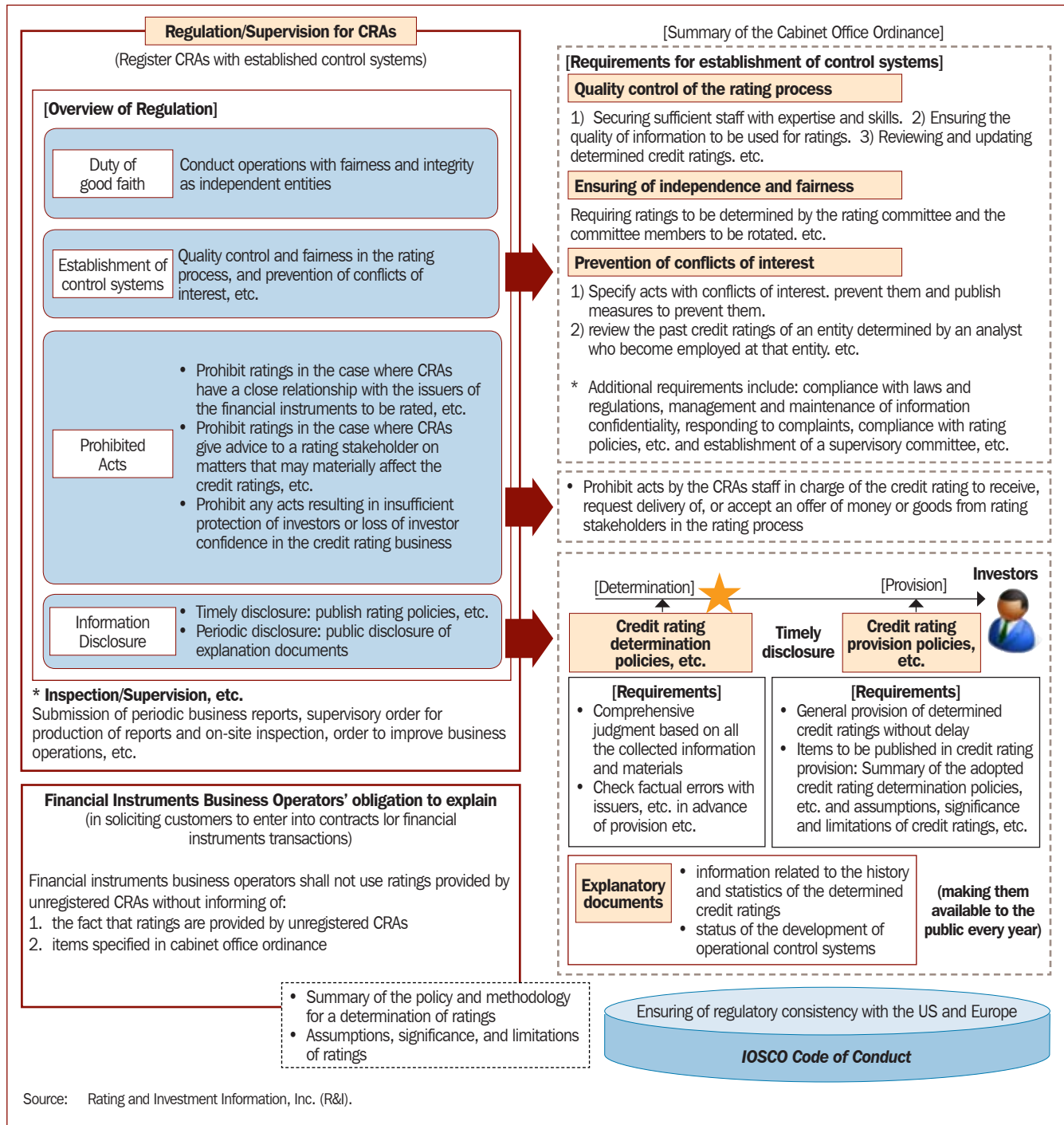

Figure 1.3 Introduction of Regulation for CRAs (II)



b. Summary of the “Guidelines for Supervision of Credit Rating Agencies” and “Summary of Credit Rating Agencies Regulation”

The revised FIEA came into force on 1 April 2010. The accountability of securities companies came into force on 1 October 2010.

Figure 1.3a Guidelines for Supervision of Credit Rating Agencies (Summary)

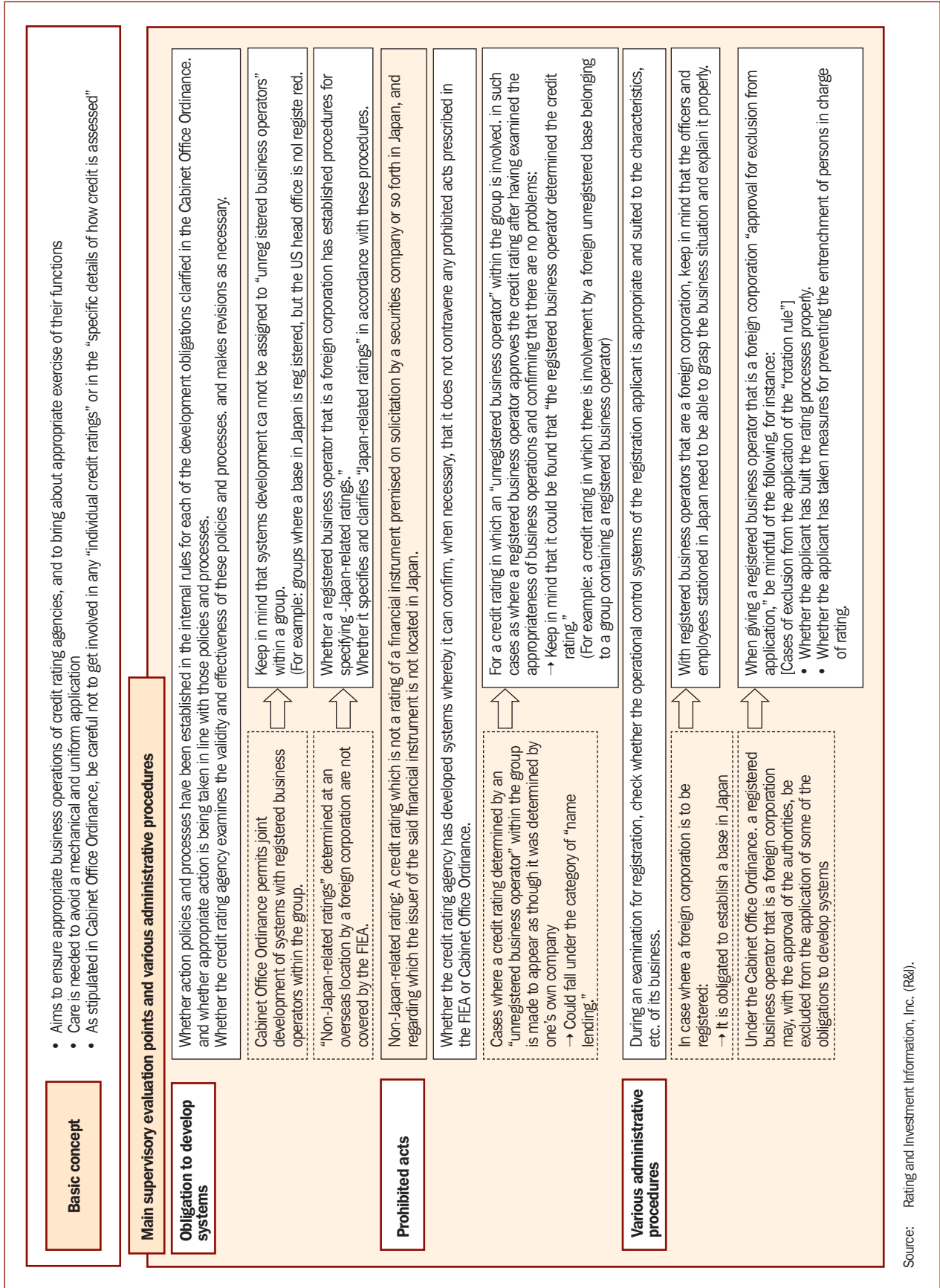

Source: Rating and Investment Information, Inc. (R&I).

Figure 1.3b Guidelines for Supervision of Credit Rating Agencies (Reference)

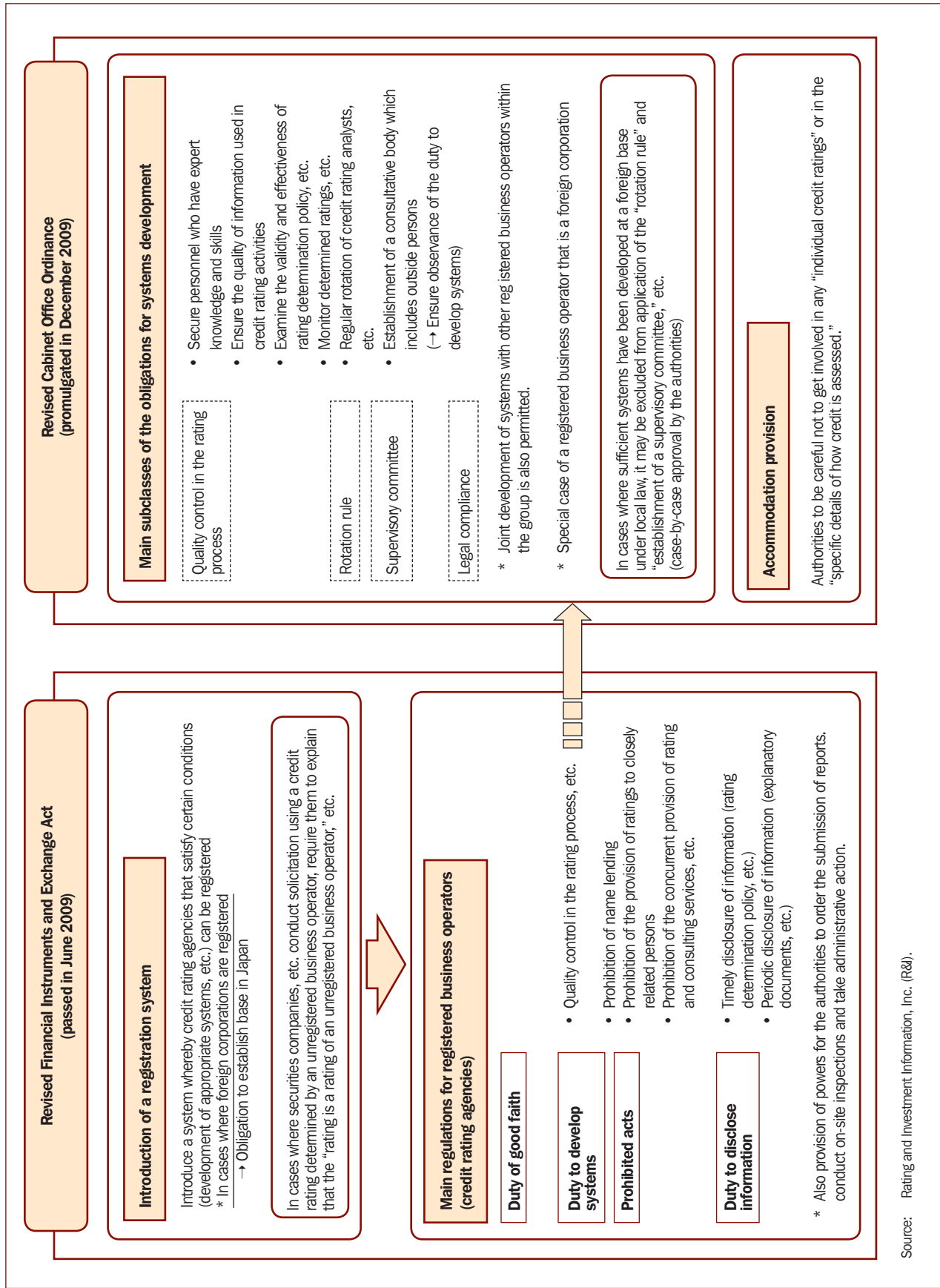

Source: Rating and Investment Information, Inc. (R&I).

I. Market Category: Public Offering and Private Placement

In the Japanese bond market, the FIEA distinguishes between public offering (PO) and private placement (PP) of securities very clearly, irrespective of whether they are domestic or foreign.

1. Public Offering

A public offering is generally subject to requirements to disclose the solicitation documents stipulated in the FIEA, whereas a private placement is not. The disclosure requirements by way of filing a Securities Registration Statement (SRS) and delivering a prospectus under the FIEA and a related Order for Enforcement and Cabinet Office Ordinances are applicable to the solicitation of the public, i.e., public offering, for either an initial issue or sale of existing securities. In short, the following categories are not deemed to be a public offering but are offered:

- a. to a small number of investors (the Small Number [SN]-PP) or
- b. to qualified institutional investors (the Qualified Institutional Investor [QII]-PP) or
- c. to specified investors (the Offer to Specified Investors [SI]) (Japan Rule 2-31 offering or Japan Professional Securities Market [PSM] Offering)

2. Private Placement

The FIEA prescribes the following three categories as a private placement. As to newly issued securities, any offering other than these three categories is categorized as a public offering:

a. The Small Number-Private Placement

The SN-PP is a private placement to less than 50 persons. The requirements for the SN-PP are as described below.

- i. The total number of persons to whom the solicitation of an offer for acquisition is to be made within any 6-month period (in case of newly issued securities) or 1-month period (in case of already-issued securities) is 49 or less (the SN-PP); In calculating the number of solicited persons for the purpose of the SN-PP, which is less than 50 during a 6-month period or 1-month period, the number of the QIIs is excluded from the total number of solicited persons only if the offer to such QIIs fulfills the requirements of the QII-PP set forth below (2-b) (i) to (iii).
- ii. The kind of securities offered is not the same as (a) securities for which continuous disclosure is made or (b) “securities for specified investors.”
- iii. Depending on the kind of securities, a certain restriction of transfer is required. For instance, an SN-PP of bonds requires either
 - (a) restriction of transfer other than en bloc transfer or
 - (b) number of the investment unit (e.g., number of bond certificates to be delivered) being less than 50 and dividing the investment unit being prohibited. Such transfer restriction must be
 - (x) written on the bond certificates to be delivered,
 - (y) written on the offering document or
 - (z) disclosed through the book-entry system of Japan Securities Depository Center Inc. (JASDEC).

In addition, in general, the offer of the securities must deliver a document, which states that no SRS has been filed for the SN-PP and describes the contents of the transfer restriction.

b. The Qualified Institutional Investor-Private Placement

The QII-PP is an offer for acquisition to be made exclusively to QIIs. The requirements for the QII-PP are as described below.

- i. Offerees are limited to QIIs.
- ii. The kind of securities offered is not the same as
 - (a) securities for which continuous disclosure is made or
 - (b) “securities for specified investors.”
- iii. Any transfer of the securities is prohibited unless the transferee is a QII; such transfer restriction is written on the certificates of the securities to be delivered or offering document, or disclosed through the book-entry system of JASDEC.

In addition, the offeror of the securities must deliver a document, which states that no SRS has been filed for the QII-PP and describes the contents of the transfer restriction.

With respect to a private placement of newly issued securities for QIIs, if the issuer of the securities is a foreign entity, the issuer is required to appoint an issuer’s agent who is a resident of Japan, according to Art. 1–3 of the *Cabinet Office Ordinance on Disclosure of the Contents of Foreign Bond Issuers* (外国債等の発行者の内容等の開示に関する内閣府令). The objective of this ordinance is to be considered to notice if there is a breach of obligation of the notice relating to the restrictions on resale. This ordinance is applicable just for the QII-PP and not applicable for the TOKYO PRO-BOND Market.

c. The Offer to Specified Investors

The Offer to Specified Investor (SI) is a newly added provision in 2008 under Japan Rule 2–31 Offering (Japan PSM Offering). The solicitation for acquisition is to be made exclusively to Specified Investors. Legally, the Offer to SI is categorized as a type of private placement. The definition of the “specified investor” is stipulated in Art. 2, Par. 31 of the FIEA. However, the economic nature of the Offer to SI can be similar to a public offering because the concept of Specified Investor is much broader than QII (please see - Definition of the Specified Investor) and the number of offerees is not limited under the Offer to SI.

The summary of the requirements for the Offer to SI are as described below.

- i. Offerees are limited to SIs.
- ii. Solicitations are made by financial instruments business operators, etc. (i.e., securities companies and other financial institutions authorized to operate securities business), in general.
- iii. The kind of securities offered is not the same as securities for which continuous disclosure is made.
- iv. Solicitation is made on the condition that a purchase agreement is executed, which provides among other things, that the person who has purchased the

securities shall not transfer them otherwise than to Specified Investors or certain non-resident of Japan.

Since the Offer to SI is categorized as the PP, the disclosure requirements do not apply. However, the issuer of the securities is required to provide concise ‘specific security information’ with respect to the securities and the issuer. Specific security information basically refers to the information that combines two pieces of information about securities that are issued to specified investors and issuer information. If the issuer is a listed company, the specific security information means information about the security.

The TOKYO PRO-BOND Market was created based on this new scheme.

3. Small Amount Placement

A public offering shall not be made unless the issuer has filed an SRS with the Director-General of the Kanto (or other applicable) Local Finance Bureau unless any one of the exemptions applies. One of such exemptions is Small Amount Placement, under which the total amount of the issue price of securities offered in Japan (the “Issue Price”) is less than ¥100 million. In calculating the ¥100 million, the amount of certain simultaneous and/or past offering shall be aggregated.

The Small Amount Placement is not literally a private placement, but rather a special form of public offering exempted from the filing requirement under the FIEA. In the case of a Small Amount Placement where the minimum issuing amount (face value) is less than ¥100 million and more than ¥10 million, a Securities Notice (SN) rather than the SRS must be submitted to the Local Finance Bureau. The SN, which is not made available for public inspection, must be filed by a day before the commencement of solicitation.

4. Exemptions for Already-Issued Securities

As to already-issued securities (i.e., secondary transactions), there are several exemptions from disclosure requirements in addition to those described above.¹² Government bonds and Public bonds are exempt from the disclosure requirement. Such exemptions include the following:

- i. Transactions at stock exchanges;
- ii. Block trades between financial instruments business operators (i.e., securities companies and other financial institutions authorized to operate securities business) or SIs;
- iii. Certain transactions between financial instruments business operators;
- iv. Sale of securities (for which any PP has not been made in the past) between people who have close relationships with the issuer (e.g., directors of the issuer, major shareholders of the issuer, parents or subsidiaries of the issuer) or financial instruments business operators (provided that transactions of both parties, of which are financial instruments business operators, are excluded);
- v. Sale of securities (for which any PP has not been made in the past) by a person who is not listed in (iv) above;

¹² As stated earlier in the discussion on corporate bonds, asset-backed bonds and nonresident bonds are subject to disclosure requirements under the FIEA.

- vi. Public offering of already-issued securities for which continuous disclosure is made; and
- vii. Public offering of certain foreign-issued securities by financial instruments business operators.

Transactions listed from (i) to (v) are excluded from the definition of “public offering” and therefore the disclosure requirements do not apply.

Transactions listed from (vi) and (vii) are categorized as public offerings, but disclosure requirements are modified.

For transaction (vi), an SRS is not required, and prospectus and SN are required only under limited circumstances.

For transaction (vii), an SRS, prospectus and SN are not required, although the financial instruments business operators offering foreign securities must, in general, provide a minimum level of information on the securities and the issuer at the time of offering, any time the investors make a request after the offering and at a time when certain material events (such as default of the issuer) occurs after the offering.

J. Definition of the Specified (Professional) Investor

The definition of Specified Investor is prescribed in Art. 2, Par. 31 of the FIEA. The following are the categories of specified investors.

1. Qualified Institutional Investors (QII), meaning persons specified by a Cabinet Office Ordinance as those having expert knowledge of and experience with investment in securities;
2. The State (Japan);
3. The Bank of Japan (BOJ); and
4. Investor Protection Funds and other juridical persons specified by a Cabinet Office Ordinance, excluding those that are deemed to be non-specified investors according to agreements (opt-out).
5. Corporations and individuals that are deemed to be specified investors according to agreements (opt-in).

QIIs include securities companies, investment management companies, investment corporations, foreign investment corporations, banks, insurance companies, certain pension funds, and general partners of certain partnerships.

Juridical persons referred to in (4) above include companies whose shares are listed on stock exchange(s) in Japan, companies whose stated capital is likely to be ¥500 million or more, and foreign corporations.

The specified investors listed in (4) above may opt out of the status as SIs by an agreement with the financial instruments business operator.

Corporations and individuals that are not included in any one of (1) to (4) above may opt in by an agreement with the financial instruments business operator.

To become an SI, an individual is required to have net asset of ¥300 million or more, financial assets of ¥300 million or more, and investment experience at least 1 year.

K. Creation of the New Market for Specified (Professional) Investor

The following is an extract of FSA's statement related to the new market for SIs.

Box 1.1 Extract from Financial Services Agency on the Development of Markets for Specified (Professional) Investors

Plan for Strengthening the Competitiveness of Japan's Financial and Capital Markets

I Creation of reliable and vibrant markets

(ii) Development of a framework for markets intended for professionals

In other countries, markets with a high degree of freedom intended for professional investors are expanding, such as the AIM (Alternative Investment Market) in the United Kingdom and the market based on Rule 144A of the United States Securities and Exchange Commission (SEC). This trend has been intensifying the international competition in creating attractive markets.

Investor protection, including through disclosure, will continue to gain greater importance in Japan. However, it is also essential to differentiate professional investors from general investors and allow the former more freedom in transactions under the principle of self-responsibility, from the viewpoints of making the country's financial and capital markets more vibrant and strengthening their international competitiveness.

Measures will be taken to establish markets among professionals that allow a high degree of freedom in transactions. The aim of this work is to raise the attractiveness of Japan's financial and capital markets as the places for financing and investment by expanding financing opportunities for foreign companies and Japanese start-ups in Japan, and to promote financial innovation through competition among professional investors. To this end, a framework utilizing the existing systems, including of private offerings to professionals, will be put in place by the end of 2008. This will be followed by the development of a new framework, based on new disciplines, for an exchange market, the participants of which will be expanded to include professional investors.

[3] Specified Financial Instruments Exchange Market (Japan rule 2-31 offering market) or (Japan PSM Offering Market)

Under the FIEA, the financial instruments exchanges are allowed to create a market in which the listed securities may not be transferred to any person other than specified investors or certain non-residents of Japan. Such financial instruments exchange market is defined as "Specified Financial Instruments Exchange Market" in the FIEA.

Securities that are listed on a Specified Financial Instruments Exchange Market but not listed on a regular financial instruments exchange market are defined as "Specified Listed Securities" in the FIEA. Holders of Specified Listed Securities may not transfer them to any person other than specified investors or certain non-residents of Japan both at the financial instruments exchange and over-the-counter, unless the issuer of the securities files a SRS in advance.

Note that the Tokyo Stock Exchange (TSE) Group is limiting the investors to the TOKYO PRO-BOND Market as described below.

L. TOKYO PRO-BOND Market: New Listing System in Japan

1. Preface

Fortunately, in the past several years, the impediments isolating the domestic market from foreign markets have been removed in Japan through the efforts of policymakers and market participants. Here the market participants can see the opportunity to put an end to the state of isolation of Japan's domestic markets.

In 2008, the FSA revised the FIEA as part of its plan to enhance the competitiveness of Japan's financial and capital markets, establishing the legal framework for markets oriented towards professional investors (an offering system for Specified Investors and Specified Financial Instruments Markets stipulated in the FIEA). This provides the legal framework for the establishment of a new securities market under Japan Rule 2–31 Offering Market) or (Japan PSM Offering Market), which is different from the general public offering system and has a wider range of investors than the U.S. Rule 144A market.¹³

In addition, the taxation system was reformed in FY2010 to reduce tax on revenues from domestic bonds held by non-residents to zero. Having done away with these twin constraints in the legal and taxation systems that have conceptually separated domestic bonds from Eurobonds and other international bonds in Japan, if appropriate rules are provided for disclosure and registration (listing) in the near future, the necessity for separating domestic and international bonds will decline. The Japanese market participants will then witness a radical improvement in the mobility and the convenience of the Japanese corporate bond market.

2. New Listing System in Japan

a. Objective

The TSE Group established the listing system as outlined below for bonds on the TOKYO PRO-BOND Market in May 2011.

- i. The TOKYO PRO-BOND Market is a specified financial instruments market as prescribed in Art. 2, Par. 32 of the FIEA.
- ii. The TOKYO PRO-BOND Market is operated by TOKYO AIM, Inc. (hereinafter, “the Exchange”) as a different market from the TOKYO AIM stock market. The types of securities that may be listed on the TOKYO PRO-BOND Market are as follows:
 - (a) **Straight bonds.** Corporate bonds listed in Art. 2, Par. 1, Item 5 of the FIEA (including bonds issued by mutual companies, but excluding bonds with warrants (as prescribed by Art. 2, Item 22 of the *Companies Act*).
 - (b) **Bonds issued by government agencies.** Bonds issued by legal entities pursuant to the special laws listed in Art. 2, Par. 1, Item 3 of the FIEA.

¹³ The Rule 144A market is a market exempted from disclosure for private offerings under Rule 144A introduced to the *Securities Act of 1933* by the U.S. Securities and Exchange Commission in 1990. When bonds and other instruments targeting professional investors are issued in the U.S. markets, rather than employing public offerings, which entail stringent legal standards for document disclosure, it is normal to follow Rule 144A (*Securities Act of 1933*) and make the offering exclusively to qualified institutional buyers. In the U.S., the Rule 144A market is available as a domestic professional investor market and the *Regulation S* market is available as an offshore professional investor market that waive disclosure requirements. *Regulation S* provides for a safe harbor (i.e., exemption from disclosure) in the case of transactions conducted outside the U.S., while Rule 144A provides for a safe harbor even in the case of transactions within the U.S. for qualified institutional buyers. In both cases, resale within the U.S. is on principle restricted to qualified institutional buyers under Rule 144A.

The precursor of Rule 144A was Regulation D (1982), composed of Rules 501 to 508, and concerning private offerings made within the U.S. Regulation D stipulated the conditions for accredited investors. However, while Regulation D entailed an asset test, the precondition that an investor possessing assets had the ability to make judgments on all investments was criticized as being ludicrous, and Rule 144A replaces the asset test with an ownership and investment securities test (i.e., it incorporates elements of experience in investment in risk securities).

- (c) **Bonds issued by funds.** Investment corporation debentures and those foreign investment securities that are similar to investment corporation debentures, as prescribed in the *Act on Investment Trusts and Investment Corporations*, as outlined in Art. 2, Par. 1, Item 11 of the FIEA.
- (d) **Municipal bonds.** Municipal bonds listed in Art. 2, Par. 1, Item 2 of the FIEA.
- (e) **Specified company bonds.** Specified company bonds prescribed in the *Act on the Liquidation of Assets* listed in Art. 2, Par. 1, Item 4 of the FIEA.
- (f) **Beneficiary certificates of Special Purpose Trusts.** Securities enumerated in Art. 2, Par. 1, Item 13 of the FIEA, and the amount of cash distributions of which during the trust period are predetermined.
- (g) **Securities or notes issued by foreign countries or foreign entities.** Those that maintain the qualities of the above.
- (h) **Government bonds issued by foreign sovereigns.** Among the securities listed in Art. 2, Par. 1, Item 17 of the FIEA, instances that have the qualities of the securities listed in Item 1 of the said paragraph.

b. Initial Listing Application

- i. The listing of bonds on the TOKYO PRO-BOND Market is carried out through an application by issuers. It is not necessary to retain a nominated adviser (J-Nomad), which is required for TOKYO AIM stock market, in the TOKYO PRO-BOND Market.
- ii. The initial listing applicant is required to submit an initial listing application and initial listing application documents to the Exchange for listing.
 - (a) The initial listing applicant may consult or make inquiries with the Exchange prior to listing regarding the initial listing application.
 - (b) The initial listing applicant shall state in the initial listing application documents that there are no false statements in the documents.
- iii. The initial listing applicant is required to publish Specified Securities Information (specified securities information prescribed in Art. 27-31 of the FIEA) at the time of filing an application of a listing of bonds.
 - (a) Specified Securities Information is required to be prepared based on the format stipulated by the Exchange or other formats approved by the Exchange as appropriate. For example, the disclosure formats utilized in the Euro market may be approved to be used. Besides, the language of disclosure of Specified Securities Information is required to be either Japanese or English, or both. Foreign issuers do not have to translate their English documents into Japanese.
 - (b) Parties seeking to apply for a bond listing can register the maximum aggregate amount of bonds issued in a program by publishing the “Program Information” pursuant to the rules established the Exchange. Specifically, information on the maximum limit of the outstanding balance and other information shall be described in the Program Information, the validity period of which is 1 year (equivalent to Euro medium-term note [MTN] program). In the case where an issuer publishes the Program Information, such issuer is allowed to prepare the Specified Securities Information only with the remaining information. In the case where the issuer publishes the adequate Specified Securities Information after the registration of Program Information, the listing will be accepted by the Exchange following the

submission of an initial listing application and initial listing application documents including the Specified Securities Information.

- (c) Under the FIEA, if the initial listing applicant is a continuous disclosure company (a company which is obliged to submit the Annual Securities Report annually), publishing Issuer Filing Information (see 3 b (ii) below for details) is not required. Also, under the rules established by the Exchange, that the disclosure company can omit the corporate information from description in Specified Securities Information, provided that such Specified Securities Information contains a notice that the company submits the Annual Securities Report.

c. Qualification Requirements for Initial Listing Companies and Underwriters

The initial listing applicant must satisfy all of the requirements listed below when listing bonds on the TOKYO PRO-BOND Market:

- i. The said bonds obtain a credit rating from a CRA (meaning registered CRAs stipulated in Art. 2, Par. 36, of the FIEA and rating agencies established under foreign laws that are subject to frameworks of regulations and supervision equivalent to those of registered credit rating agencies.). A credit rating for the above mentioned Program Information may be used as the credit rating.
- ii. The securities company that serves as Managing Underwriter for bonds to be listed on the Exchange is required to be registered on the Exchange's Managing Underwriter List.
 - (a) Any securities company that wishes to register to appear on the Managing Underwriter List can apply with the Exchange. The Exchange will then decide whether to approve the registration based on consideration of the company's track record in corporate bonds underwriting, among other things. The Exchange will also assess the ongoing eligibility of securities companies to be included on the Managing Underwriter List.
 - (b) The requirements for companies registered on the Managing Underwriter List will be different from those for J-Nomads in that they will have no duties to the Exchange in respect of the Qualification Requirements for Initial Listing Companies and will have no post-listing duties.

d. Approval of Listing

Once it has confirmed that the initial listing applicant satisfies the requirements for initial listing, the Exchange approves the listing of the bonds and publicly announces it straightway in a timely manner.

3. Obligations after Listing

a. Timely Disclosure

The issuer of listed bonds must disclose the Issuer's Information in a timely, accurate, fair and investor-oriented manner.

- (a) The matters that the issuer of listed bonds is required to disclose are different from those for equity listings. The issuer of listed bonds is only required to disclose matters such as dissolution, bankruptcy or default. Disclosure of other information is optional.
- (b) Legally, in the case of corporate bonds, the important matters subject to insider

trading regulations are limited to dissolution, bankruptcy, or default (Art. 166, Par. 6, Item 6 of the FIEA, Art. 32-2 of the “Enforcement Order” of the FIEA, and Art. 58 of the “Order for Enforcement on Regulation of Trading of Marketable Securities”).

- (c) Timely disclosure obligations are not imposed on issuers of stocks listed on a domestic or foreign financial exchange, fully-owned subsidiaries of such issuers, or issuers of securities other than straight bonds, bonds issued by government agencies, and bonds issued by funds.

b. Financial Information

The issuer of listed bonds is required to publicly announce Issuer Filing Information as prescribed in Art. 27–32 of the FIEA at least once per year.

If the issuer of listed bonds is a continuous disclosure company, the issuer of listed bonds is not required to publish Issuer Filing Information under the FIEA.

4. Delisting

a. Delisting

In instances where the Exchange deems delisting appropriate, the Exchange will delist the said listed bonds, as enumerated below.

- i. To reach the final redemption date
- ii. Acceleration of the final redemption date in relation to the full amount of bonds
- iii. Absorption-type corporate split or new incorporation with succession by a new entity to obligations related to a listed bond issue
- iv. Material misstatement by an issuer of listed bonds in the Specified Securities Information, Issuer Filing Information, or the Annual Securities Report
- v. Call for immediate redemption of listed bonds due to a default event
- vi. Further to the above, determination by the Exchange that delisting is appropriate.

b. Warning Measures

In instances deemed necessary, the Exchange will take warning measures, or impose a penalty or other means on the issuer of listed bonds, and, if deemed necessary, may publicly announce this measure.

5. Listing Fees

Listing Fees to be paid by the issuer of listed bonds to the Exchange is charged on the registration of program information and listing of the bonds.

6. Trading System, Settlement and Clearance System

The Exchange launched a trading system and a settlement and clearance system, but investors can choose to trade in the OTC market. It is assumed that the main market for the bonds will be the OTC market.

M. Commissioned Company for Bondholders System

1. Summary

In cases where a company will issue bonds in Japan, generally speaking the company

must specify a commissioned company or person for bondholders and entrust the receipt of payments, the preservation of rights of claim on behalf of the bondholders, and other administration of the bonds to that manager; provided, however, that this shall not apply in cases where the minimum issuing amount (face value) of each bond is ¥100 million or more as prescribed by the Companies Act. This implies that the minimum face value of the note of ¥100 million or more will only be sold to professional investors and will not be sold to individuals. Other cases prescribed by the applicable ordinance of the Ministry of Justice are cases where it is unlikely that the protection of bondholders will be compromised.

2. Commissioned Company for Bondholders System

A drastic reform of the conventional corporate bond trustee system was carried out by amending the *Commercial Code* in June 1993. Under this amendment, the conventional name “bond trustee company” was changed to “commissioned company,” and its function was clarified. More specifically,

- a. establishment of a commissioned company was made mandatory, in principle, and the eligibility for becoming one is restricted to banks, trust companies, and companies that have received a license under the *Mortgage Bond Trust Law*;
- b. services to be provided by a commissioned company are restricted to the management of bonds that have been issued and are outstanding; and
- c. the power, duty, and liability of the commissioned company have been clarified.

The impact of the amendment may be summarized as follows:

- a. The fee the trustee bank had been collecting was renamed “commissioned companies fee”;
- b. By instituting exceptional provisions with respect to the mandatory engagement of a commissioned company (this applies when the minimum face value of a bond is not less than ¥100 million), issuers can appoint a fiscal agent (FA); and
- c. The previous practice that the lump purchases of defaulted bonds that trustee banks have been making were discontinued, and discontinuation has been established.

Under the *New Companies Act* adopted in June 2005 (enacted in May 2006), a commissioned company for bondholders and its liability and power have been expanded.¹⁴ More specifically,

- a. under the former *Commercial Code*, the term “administration of bond” referred only to the exercise of power legally granted to the commissioned company and person for bondholders and did not include the exercise of power based on an agreement, commissioning the administration of bonds (contractual power); under the new *Companies Act*, however, the exercise of the contractual power is included in “the administration of bonds” and the commissioned company and person for bondholders owes the duty of impartiality and good faith and the duty to exercise reasonable care and skill in exercising such contractual power;
- b. when the agreement commissioning the administration of bonds contains a provision to that effect, the commissioned company and person for bondholders act in relation to filing a lawsuit and taking bankruptcy or rehabilitation

¹⁴ Footnote 9, p. 93-95.

- proceedings for the bond as a whole without obtaining a resolution of the bondholders' meeting; and
- c. in taking steps to protect the creditors in the case of a capital reduction or a merger, the commissioned company and person for bondholders may, in principle, object to such capital reduction or merger without obtaining a resolution of the bondholders, meeting.

In an investment environment where there have been very few corporate bond defaults, a commissioned bank or commissioned person (corporate bond administrators) have not been appointed in many cases, except for corporate bonds targeting individual investors. Therefore, there is no consensus about the role of a commissioned bank or commissioned person (corporate bond administrator), and the preservation attachment for corporate bondholders when the corporate bond is in default, and no discussion has been held regarding cost sharing.

N. Japan Securities Dealers Association's Self-Regulatory Rules and Guidelines for the Bond Market

In light of most bond transactions conducted via OTC in Japan, JSDA, the full-fledged self-regulatory (SRO) for the securities industry in Japan, has issued a variety of rules and market practices for bond market participants. Some of the oldest of JSDA's self-regulatory rules were introduced as administrative guidance by the financial authority. As the role of financial authority and JSDA became clearly separated, these rules fell under the purview of the JSDA, and today function as self-regulatory rules.

The main categories of these rules and guidelines are as follows:

1. Self-Regulatory Rules

JSDA members must comply with these rules. Their coverage ranges from items be observed in outright transactions (purchase or sale) such as compliance with the laws and regulations, maintenance of fairness of transactions, prohibition of extraordinary transactions,¹⁵ preparation and maintenance of trading records, and reporting of trade turnovers to items to be complied with in special transactions such as repurchase transactions and OTC options transactions (such as requiring contracts, limiting the types of counterparties, etc.).

Regarding the rule requiring contracts, JSDA has prepared a model format that has become the de facto standard in Japan, as specified below.

- a. OTC transactions in same-bond issues in which sales and purchases are effected simultaneously at prices favorable to customers or the third parties, but unfavorable to Association Members (the price differential that corresponds to a proper interest based on a difference in the delivery date and the price differential which corresponds to the differential in delivery terms between the cash bonds and registered bonds are excluded);

¹⁵ Art. 16 of JSDA's *Regulations Concerning Publication of Over-the-Counter Trading Reference Prices of Bonds and Trading Prices* prescribes that Association Members must not affect the acts set forth in each of the following items and any other acts with the aim of compensating for the customer's loss or adding to his/her profit (hereinafter referred to as "Extraordinary Transactions").

- b. The act of repurchasing or selling at prices favorable to customers performed in purchasing bonds from or selling bonds to customers, or transactions effected on the basis of prior promises that contracts will be cancelled (Gensaki Transactions are excluded); or
- c. A transaction to be conducted in collusion with a third party promising in advance on the occasion of selling a bond to a customer or purchasing it from a customer that the customer will be sure to gain profits by selling the bond to, or purchasing it from, the third party.

When JSDA members violate these rules, they are subject to disciplinary action by the JSDA (if a JSDA member commits a breach of the rules together with a non-member (customer), only the JSDA member is subject to the disciplinary action).

The JSDA takes into account market conditions and the practical reality of transactions in establishing, revising and abolishing rules for the purpose of achieving fair and smooth transactions in the Japanese market, thereby contributing to the protection of investors. During the rule-making procedure, a draft of rules is prepared first through deliberations mainly by JSDA members, subjected to public comment and other processes, and finally approved by JSDA.

Box 1.2 Japan Securities Dealers Association Regulations for Bond Transactions

- *Regulations Concerning Underwriting, etc. of Securities
- *Detailed Rules Relating to the Regulations Concerning Underwriting, etc., of Securities
- *Detailed Rules Relating to The Regulations Concerning Publication of Over-The-Counter Trading Reference Prices, etc., of Bonds and Trading Prices
- *Regulations Concerning Publication, etc. of Over-The-Counter Quotation of Corporate Bonds, etc. for Retail Customers
- *Regulations Concerning Solicitation, etc., of Sale and Purchase Transactions of Domestic CPs etc., and Private Placement Corporate Bonds
- *Regulations Concerning Handling of Sale and Purchase of Bonds with Options
- *Regulations Concerning Handling of Conditional Sale and Purchase of Bonds, etc
- *Regulations Concerning Handling of Transaction of Bonds, etc. with Delayed Settlement
- *Regulations Concerning Handling of Short Sale and Lending Transaction of Bonds
- *Regulations Concerning Distributions, etc. of Securitized Products

Source: Japan Securities Dealers Association

2. Guidelines

Guidelines are practical rules that JSDA requests participants in the bond market to comply with, thus recognized as “best practice”. As they are merely practices, those who do not comply with these are not penalized. However, as voluntary compliance with these guidelines by the overall market contributes to smooth and efficient transactions, most market participants observe the guidelines. Consequently, JSDA collects and considers the opinions of market participants when setting new guidelines or revising or abolishing old ones.

Recently, JSDA has published guidelines concerning delivery and settlement practices such as “Deadline for Settlement (Cut-off Time),” “Handling of Fails Charges,” and order conclusion practices for JGBs when-issued transactions.

3. Others

Besides the above, JSDA issues from time to time notices to association members in advance regarding standard procedures, such as the standard calculation method of accrued interests, to eliminate the necessity of getting individual consensus between related parties regarding the unification of procedures among market participants.

O. Tokyo Stock Exchange's Self-Regulatory Function

The TSE fulfills a number of duties related to the operation of a securities market. It examines companies to assess their suitability as listed companies, it requires these companies to comply with disclosure requirements so that investors are able to make informed decisions, and it provides a market place for those companies' shares to be traded. Pursuant to the FIEA, TSE has self-regulatory functions to maintain a transparent, equitable and reliable market. The provision of such a market helps support a healthy economy.¹⁶

The TSE has two units in relation to its self-regulatory function: the Listing Regulation Unit and the Compliance Unit.

1. Listing Regulation Unit

The Listing Regulation Unit is engaged in various activities to ensure the soundness and fairness of the securities market with a focus on issues related to listing. This unit is comprised of the following two divisions:

- a. The Listing Examination Division, which conducts examinations of companies aspiring to list on the TSE to determine each company's listing eligibility.
- b. The Listed Company Compliance Division, which conducts examinations related to information disclosure of companies already listed on the TSE, and determines their eligibility to continue to be listed.

2. Compliance Unit

The Compliance Unit is engaged in various activities to ensure the soundness and fairness of the securities market with a focus on issues related to trading participants. This unit is comprised of the following two divisions:

- a. The Participants Examination and Inspection Division, which conducts activities such as inspections of banks, securities companies, and other trading participants who possess the qualifications necessary to conduct securities trading on the TSE.
- b. The Market Surveillance and Compliance Division, which conducts detailed investigative activities to ensure that transactions such as insider trading, market manipulation, and other potentially unfair transactions do not occur, in order to preserve the fairness and trustworthiness of the securities market.

3. Self-Regulation Punishment and Dealing with Offenders

TSE Regulation handles any trading participant that violates the law or the stock exchange rules in accordance with Art. 34 of the *Official Trading Participant Regulations*.

¹⁶ Tokyo Stock Exchange. <http://www.tse.or.jp/english/sr/compliance/gaiyo.html>

The “Disciplinary Committee” is an advisory body that, in addition to conducting inquiries, also handles penalty funds, censure, trading suspension, and limiting or canceling trading capabilities.

P. TOKYO AIM’s Role as TOKYO PRO-BOND Market Self-Regulatory Organization

TOKYO PRO-BOND Market-related rules and regulations are provided by the TOKYO AIM, Inc.¹⁷ TOKYO AIM is an SRO for the TOKYO PRO-BOND Market. Among others things, disclosure requirements under the FIEA such as SRS do not apply to the securities listed on the TOKYO PRO-BOND Market. Instead, disclosure requirements stipulated in the rules and regulations of TOKYO AIM, Inc. such as the Specified Securities Information and the Issuer Filing Information applies to them.

In principle, information on listed bonds and information on their issuers shall be disclosed pursuant to the TOKYO AIM’s TOKYO PRO-BOND Market “Listing Regulations and Enforcement Rules.”¹⁸ Also, the listing, initial offering and trading (if any) of the bonds on and in the TOKYO PRO-BOND Market are regulated under TOKYO AIM’s “TOKYO PRO-BOND Market Listing Regulations and Enforcement Rules.” In addition to these, trading on the market is regulated under JSDA’s “Self-Regulatory Rules and Guidelines for the Bond Market.” TOKYO AIM’s “TOKYO PRO-BOND Market Listing Regulations and Enforcement Rules” and JSDA’s “Self-Regulatory Rules and Guidelines for the Bond Market” have a mutually important and complimentary relationship.

Q. Bankruptcy Procedures and Bonds

There are four statutory insolvency proceedings that apply to Japanese corporations. Each can be categorized into one of two general types, depending on whether the aim of the proceedings is to liquidate the company (“Liquidation-type Proceedings”) or rehabilitate the company (“Rehabilitation-type Proceedings”):

1. Liquidation-type Proceeding
 - a. Bankruptcy proceedings (*hasan*) under the Bankruptcy Act; and
 - b. Special liquidation proceedings (*tokubetsu seisan*) under the *Companies Act*.
2. Rehabilitation-type Proceedings
 - a. Corporate reorganization proceedings (*kaisha kosei*) under the *Corporate Reorganization Act*; and
 - b. Civil rehabilitation proceedings (*minji saisei*) under the Civil Rehabilitation Act.

At the time of the filing of the application for or the commencement of any of those insolvency proceedings or both, depending on the language of the default clause of the relevant bonds, the bonds will be accelerated. If a commissioned company for bondholders has been appointed for the bonds, the commissioned company will act

¹⁷ Tokyo AIM Inc. http://www.tokyo-aim.com/english/files/news/110701_qa_revised_eng.pdf

¹⁸ Refer to TOKYO PRO-BOND Market Listing Regulations and Enforcement Rules at http://www.tokyo-aim.com/english/rules/rule_collection.html

for the benefit of the bondholders as creditors of the issuer in the proceedings. If no commissioned company has been appointed, individual bondholders will be expected to act for themselves in the proceedings.

As an alternative to commencing one of the four types of statutory insolvency proceedings above, a Japanese corporation in financial distress may seek to negotiate an out-of-court restructuring of the corporation with its creditors. In the course of such negotiation, a bondholders' meeting may determine the amendment to the terms and conditions of the bonds, such as installment repayment of principal amount or reduction of the interest rate, though a court approval will be required to have the decision of the meeting take effect. The statutory bondholders' meeting system set out in the *Companies Act* is applicable only to the bonds issued by Japanese corporate issuers under Japanese law.

The "Asia-Pacific Restructuring and Insolvency Guide 2006" provides an explanation on the restructuring and insolvency frameworks of Asia-Pacific countries, including a report on Japan.¹⁹

R. Legal Definition of Debt Instruments

1. Uniform Legal Framework for All Types of Securities

- a. The *Law Concerning Book-Entry Transfer of Corporate Bonds, Stocks, and Other Securities* provides the legal basis for the book-entry transfer system and dematerialization of all securities.
- b. JASDEC performs the role of the Central Securities Depository (CSD) in the book-entry transfer system in securities other than government bonds. In this law, the term CSD means "Designated Depository Institution." Book-entry bond transfer system participants must observe the rules established by the depository institution.

2. Dematerialization or Immobilization versus Physical Securities

- a. As described above, according to this law and the above system for securities to be distributed, it has realized the complete dematerialization.
- b. The *Companies Act* allows that the form of physical bond certificates to be issued regardless of the book-entry transfer method. However, in this case distribution in the market cannot be expected, and it is also not allowed to be owned in tax-exempt status under the Japanese taxation system.

3. Legal Ownership Structure of Dematerialized or Immobilized Securities

- a. In the book-entry transfer institutions, securities companies and financial institutions, as "Account Management Institution" may open an account for securities transfer.
- b. In the transfer account, the balance of their own account and the overall customer account are recorded respectively.

¹⁹ Asian Development Bank. 2006. *The Asia-Pacific Restructuring and Insolvency Guide 2006*. Malaysia: Shearn Delamore & Co. and PricewaterhouseCoopers. <http://www.adb.org/Documents/Guidelines/restructuring-insolvency/restructuring-insolvency.pdf>

- c. Bondholders open the transfer account in the depository institution or account management institution. By performing an electronic transfer to an account transfer record, the securities are entitled to be owned by the bondholder.
- d. In other words, the presence of the recording consists of a proof of a “perfection third party to the issuers.”
- e. Should there be an insufficient transfer-account book records in the customer’s account due to the over-recording, the “duty of retirement of over-recording” is generated by management institutions.

II. Disclosure Requirements

A. Securities Registration Statement

To make the information contained in the Securities Registration Statement (SRS) and its attachments accessible to general investors, the Financial Instruments and Exchange Act (FIEA) requires the SRS and its attachments to be filed by the issuer with the Director-General of the Kanto Local Finance Bureau or the relevant Local Finance Bureau (sometimes “FB”), and for such filings to remain open for public inspection during a period of 5 years. In addition, the issuer must keep such documents at its head office and principal branch offices and make them available for public inspection. Once the SRS is filed with the relevant Finance Bureau, solicitation may be made; but before the securities are acquired by investors, the registration must have become effective. The registration becomes effective generally after 15 days have elapsed from and excluding the day of filing (“waiting period”). The relevant Finance Bureau may designate a shorter period or may notify the issuer that the registration will become effective immediately, or will become effective on or after the day of filing, if the relevant Finance Bureau concludes that the public can easily understand the contents of the filed registration documents, or the information on the issuer has been widely disseminated to the public. In many cases, if the issuer is already filing continuous disclosure documents, the waiting period is shortened to 7 days.

If, prior to the effective date of the registration there occurs any change with respect to any material fact which should be stated in the SRS, or if there arises any situation prescribed by a relevant Cabinet Ordinance calling for the modification of the contents of the registration documents, the registrant should file an amendment to the SRS. The relevant Finance Bureau may, but is not obliged to, issue an order for filing an amendment to the SRS if it finds the registration documents defective or insufficient with respect to any material facts stated therein. Once an amendment to the SRS is filed, the aforementioned waiting period starts, on or several days after the day of filing of such amendment to the SRS, depending upon the nature of the amendment.

The SRS is generally comprised of three sections: Information Concerning Securities, Information Concerning Issuer, Information Concerning Guarantor and Special Information. In addition, for the SRS for foreign specified securities referred below, the “Information Concerning the Legal System of the Home Country of the Issuer” must

also be disclosed. In addition to the disclosure requirements, there are regulations concerning securities transactions under the FIEA designed to ensure fair trade.

B. Methods of Filing the Securities Registration Statement

The following are the methods of filing the SRS:

1. Complete Disclosure Method

The SRS must be filed by the issuer with the Director-General of the relevant Finance Bureau before the commencement of a public offering.

2. Attachment Method

Companies that filed annual securities reports for the previous year may attach annual securities reports, semi-annual securities reports or quarterly securities reports and their amendments to the SRS to avoid duplicate filing.

3. Reference Method

Companies that satisfy the requirements for (2) above, list their shares on the Stock Exchanges or OTC markets, and also satisfy additional requirements under a Cabinet Ordinance may make reference in the SRS to the documents identified in (2) and extraordinary reports rather than attaching the entire document.

4. Shelf Registration Method

Frequent issuers that qualify to use the Reference Method can also use the Shelf Registration Method to render their issue more cost-efficient and timely. Any issuer who satisfies the requirements for registration by the Reference Method may register proposed offering(s) by filing with the relevant Finance Bureau an SRS setting out the period during which the securities are intended to be offered, the kind of securities, the proposed total amount of offering and the anticipated principal underwriters, in accordance with a Cabinet Ordinance.

The shelf registration becomes effective after a shorter period (usually, 7 days) than the period in the case of filing the SRS. Once the shelf registration becomes effective, no individual SRS need be filed for the offering of any part of the securities covered by the shelf registration but the registrant should file with the relevant Finance Bureau a supplement to the SRS setting out the amount of offering and other terms of the offering. The shelf registration ceases to be effective upon the expiry of the intended period thereof. If, prior to such expiry, the offerings of the total amount registered have been completed, the registrant should file a Shelf Registration Withdrawal Statement with the relevant Finance Bureau.

If, during the effective period of shelf registration, a certain situation arises as prescribed by the FIEA and Cabinet Ordinance, the registrant should file an Amendment SRS. No such amendment can be made to increase the total amount of offerings, change the proposed period of offerings, or change the kind of securities subject to the registration.

Special provisions are made with respect to the shelf registration method for commercial papers (CPs).

C. Continuous Disclosure

Any (1) issuer of securities listed on any securities exchange, (2) issuer of securities which were subject to the registration requirement with respect to their public offering for initial issue or sale, and (3) corporation whose number of shareholders at the end of any of the past 4 business years was 1000 or more, is, generally, required to prepare and file with the relevant Finance Bureau an annual securities report and quarterly securities report in the case of (1) (limited to the issuers of shares), or semi-annual securities report in the case of other issuers every year, and, from time to time, an extraordinary report. In the case of (1) (limited to the issuer of shares), an internal control report is also required. This is collectively referred to as the "continuous disclosure requirement" as required by the FIEA). Such continuous disclosure requirement ceases when the listed securities are delisted, or upon obtaining the approval of the Financial Services Agency (FSA) when the issuer goes into liquidation, suspends its business for an extended period of time or the number of holders of the securities which were sold in the public offering for initial issue or sale is reduced to less than 25 or under certain circumstances set out in the Order for Enforcement.

Any issuer subject to the continuous disclosure requirement should prepare an annual securities report in the prescribed form within 3 months after the end of each of its business year (in the case of foreign governments or corporations, etc., within 6 months) and file the same with the Finance Bureau as provided in Art. 24, Par. 1 of the FIEA, for each year as prescribed by the Cabinet Office Ordinance.

If the business year of the issuer subject to the continuous disclosure requirement is 1 year, such issuer must generally prepare a semi-annual securities report in the prescribed form covering the first 6 months of each business year and file it with the relevant Finance Bureau within 3 months from the end of such 6-month period. If the issuer is a company whose shares are listed on a securities exchange in Japan, the issuer must file a quarterly securities report instead of a semi-annual securities report, within 45 days from the end of such quarterly period, in general. Such issuer also has to file an internal control report together with an annual securities report.

When a certain important event occurs with respect to an issuer subject to the continuous disclosure requirement, it should prepare and file with the Finance Bureau an extraordinary report without delay. The annual securities report, semi-annual securities report, quarterly securities report, internal control report and extraordinary report are made available to the public inspection via the Internet, through a system named Electronic Disclosure for Investors' Network (EDINET).

The FIEA contains provisions similar to those applicable to the SRS for amendments to the annual securities report, semi-annual securities report or quarterly securities report, internal control report, and extraordinary report, as well as relevant parties' liabilities resulting from material misstatements and omissions. In addition, issuers of listed securities are subject to various disclosure requirements prescribed by the relevant securities exchange (timely disclosure).

D. Forms of Initial Disclosure by Foreign Issuers

The main categories of the Cabinet Ordinance describing the forms of initial disclosure by foreign issuers are as follows:

1. Disclosure of Information Concerning Corporations

Cabinet Office Ordinance on Disclosure of Corporate Information (Ministry of Finance [MOF] Ordinance No. 5, 30 January 1973)

2. Disclosure of Information Concerning Issuers of Foreign Government Bonds

Cabinet Office Ordinance on Disclosure of Information, etc. on Issuers of Foreign Government Bonds (MOF Ordinance No. 26, 27 April 1972)

3. Disclosure of Specified Securities as defined under Art. 3-4 of the “Enforcement Ordinance” of the FIEA

Cabinet Office Ordinance on Information, etc. on Specified Securities (MOF Ordinance No. 22, 3 March 1993)

E. Electronic Disclosure for Investors’ Network

Disclosure documents, such as the SRS, is filed using the EDINET, which is an electronic system designed to accept disclosure documents filed under the FIEA. This system has digitized former paper-based disclosure procedures and was developed to make the securities market more efficient by reducing the reporting burden on companies and making it easier for investors to access company information. Under this system, disclosure documents are filed online to the Finance Bureau and are made available to the public through the Internet. By using this system, issuers do not have to go to the Finance Bureau in person to file their disclosure documents. Furthermore, investors can browse through all of the filed documents on the Internet and access issuer information more easily.

The programming languages used to prepare the information required in the disclosure documents are Hyper Text Markup Language (HTML) and eXtensible Business Reporting Language (XBRL).

F. Exempted Securities

As described earlier (see I. 2. Private Placement; page 24–26), Private Placement Securities are exempt from registration requirements.

Also, Japanese government bonds, municipal bonds, bonds issued by judicial persons pursuant to special law, capital contribution certificates issued by a corporation established by a special law, beneficial certificates of loan trusts, bonds guaranteed by the Japanese government, and bonds issued by an international organization of which Japan is a member (e.g., International Bank for Reconstruction and Development [IBRD] bonds and Asian Development Bank [ADB] bonds) are exempted from the registration requirement.

However, Fiscal Investment and Loan Program (FILP)-agency bonds issued by corporations established by a special laws (i.e. Development Bank of Japan Inc, Metropolitan Expressway Company Limited, Hanshin Expressway Company Limited, Narita International Airport Corporation, Kansai International Airport, Chubu International Airport) are subject to registration requirements.

III. Trading of Bonds

A. Overview

In general most of Japanese domestic investors tend to hold bonds till maturity. Having said that, the selling of bonds for switching, for profit taking and loss cutting are often undertaken by institutional investors. In recent years, by the time of the recent financial crisis of 2007-2008, bond trading volume in the secondary market continued to increase. The trading volume reached the level at ¥12,534 trillion in fiscal 2007. The sharp increase in the trading volume of bonds may be explained by a number of factors, including the following.

First, the government has continuously been issuing massive amounts of Japanese government bonds (JGBs), resulting in a large increase in those outstanding in the market.

Second, brokers/dealers and other financial institutions including banks have been engaging actively in dealing in bonds for trading gains.

Third, the government started to auction financing bills (FB) and treasury bills (TB, integrated into T-bills in 2009), which are now actively traded by market participants with short-term cash management needs.

Fourth, the growing so-called flight-to-quality trend among investors also played a part. After 2007, the movement into the bond market was prompted by a worsening in Japan's investment environment against the backdrop of the prolonged economic stagnation in recent years and the turmoil in financial markets. Additionally, government securities outweigh by far other categories of bonds in overall fixed-income trading volume. The dominance of government debts stems mostly from the difference in liquidity, which in turn is because major players are Japanese banks who have tremendous excess cash and who prefer outstanding liquidity and Bank for International Settlement (BIS) zero risk weight of Japanese government debts.

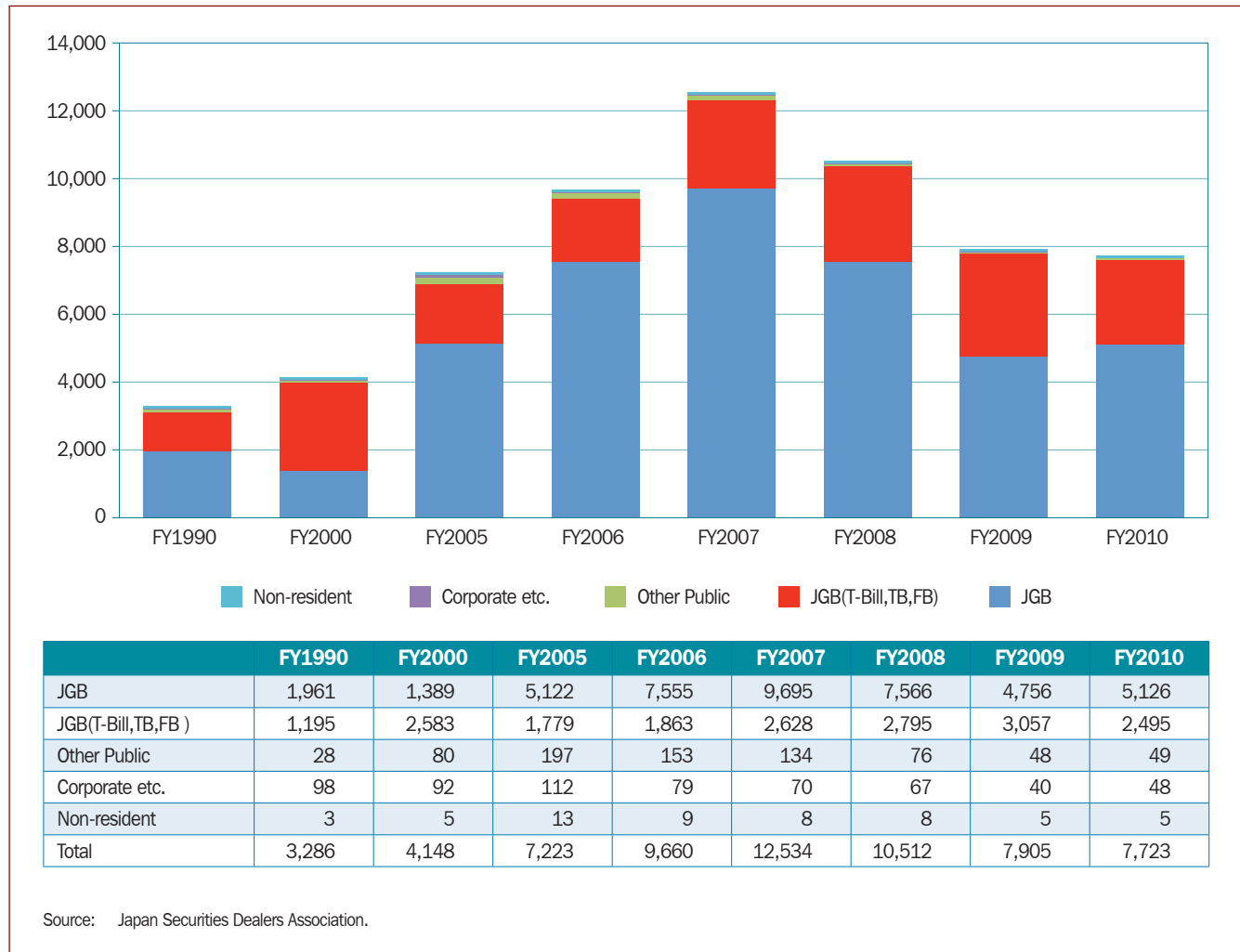
Figure 3.1 Trading Volume of Bonds (¥ trillion)

B. Participants in the Secondary Bond Market

1. Looking at the over-the-counter (OTC) bond market by type of investors or transaction parties, trading is dominated by bond dealers, such as securities companies and banks.
2. Following bond dealers, entities grouped as “Others” account for the next largest share of the total volume. This “Others” category has become a consistent and substantial net seller of bonds because primary JGBs issued by auction are settled via the Bank of Japan (BOJ) and reported as sales by the central bank. Also, JGB is buying and selling a range of debt securities as part of its open market operations.
3. Non-resident investors also are playing an increasingly and significantly large role in the Japanese bond market as a means of investing in yen-denominated government bonds and notes over the past few years in line with the flight to quality movement after the financial crisis. They are also active players in the short-term JGB market, trading TBs, FBs, T-bills, and others.

4. City banks (large commercial banks) and trust banks trade large volumes of bonds. Based on their own market view, city banks vigorously engage in bond trading in pursuit of trading profits as well as resell municipal and other bonds underwritten by them. It should also be noted that trust banks have traditionally allocated large shares of assets under management or administration, including pension assets to bonds.

When measured in terms of net trading volume, over the past 11 years, as seen in the following table, almost all business categories have been net buyers of bonds (almost JGBs and other public sector bonds). This can be attributed to the several reasons from the demand side point of view that

- (1) continuous repayment of bank loans from domestic business corporate borrowers who have generated cash constantly with their lean and efficient management,
- (2) financial institutions' reduced risk tolerance in their loan portfolios, and
- (3) continuous increase in bank deposits and savings from households and domestic corporations.

Figure 3.2 Decrease in Bank Loan and Increase in Bank Deposit (December 1999–October 2011)

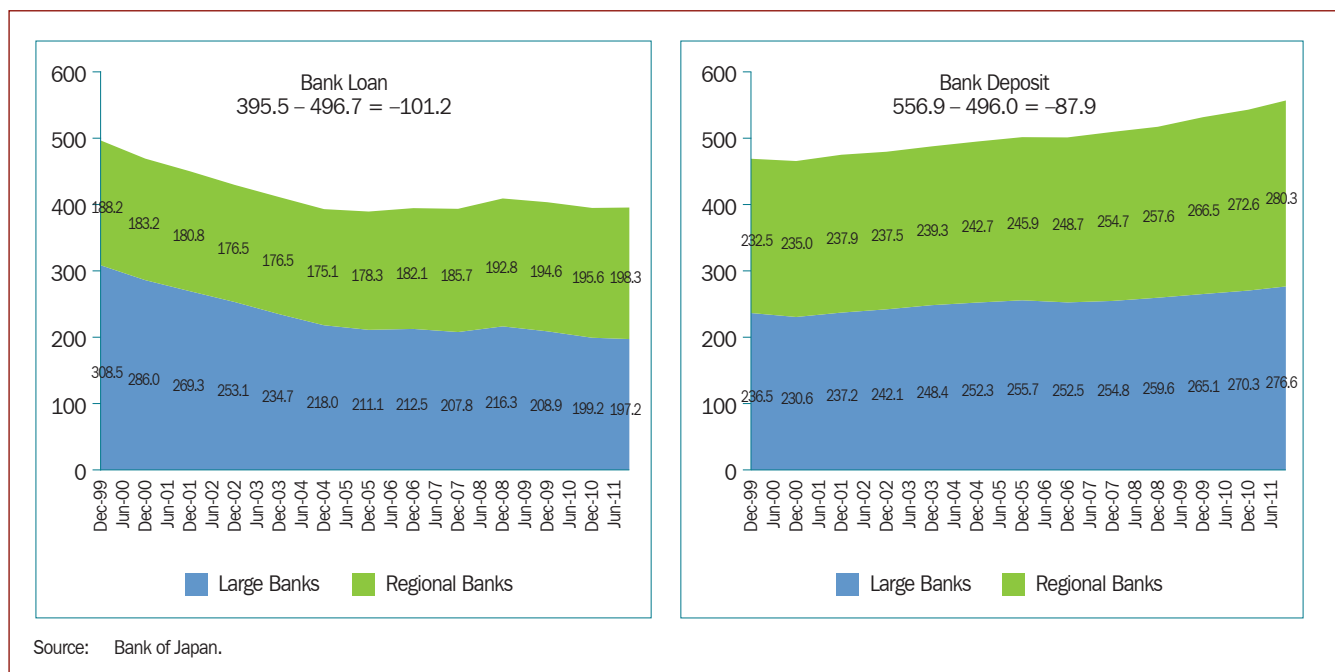

The lower appetite for risk assets has surfaced among general investors, financial institutions and non-resident investors. This trend is also evidenced by continuing depression of the stock market, and disruption and subsequent downturn in the securitization markets after the financial crisis. This trend has been continuing and even getting stronger all over the world due to tightening of financial regulations after the financial crisis and the recent Euro zone crisis. This also promoted the trend to ‘flight to quality’ and ‘flight to liquidity’ for the JGB market further.

Table 3.1 Trends in Bond Transactions by Type of Transaction Parties (¥ billion)

		FY2000	FY2001	FY2002	FY2003	FY2004	FY2005	FY2006	FY2007	FY2008	FY2009	FY2010
City (commercial) banks	Sell (a)	62,618	67,740	98,201	80,125	92,172	79,387	75,391	120,557	129,292	126,905	146,494
	Purchase (b)	97,158	90,876	140,223	136,553	173,056	153,964	101,749	130,459	154,818	163,965	144,559
	Net (a)-(b)	(34,540)	(23,136)	(42,022)	(56,428)	(80,884)	(74,577)	(26,358)	(9,902)	(25,527)	(37,060)	1,934
Regional banks	Sell (a)	10,624	11,002	13,362	14,001	10,980	10,442	9,814	15,104	13,657	16,535	18,641
	Purchase (b)	16,770	18,605	20,839	22,420	19,385	16,967	14,375	21,141	23,678	28,251	29,938
	Net (a)-(b)	(6,146)	(7,603)	(7,476)	(8,419)	(8,406)	(6,525)	(4,561)	(6,037)	(10,021)	(11,716)	(11,297)
Trust banks	Sell (a)	49,639	50,481	72,041	68,158	69,171	77,368	84,376	100,520	80,563	82,886	92,597
	Purchase (b)	66,472	65,067	93,956	102,617	117,218	119,187	128,489	141,377	120,323	158,872	156,712
	Net (a)-(b)	(16,834)	(14,586)	(21,915)	(34,459)	(48,047)	(41,819)	(44,113)	(40,857)	(39,760)	(75,986)	(64,115)
Agriculture-related banking institutions	Sell (a)	6,557	5,933	9,046	8,188	8,505	7,164	12,599	8,908	6,646	7,159	4,953
	Purchase (b)	13,414	14,571	15,341	19,517	12,008	12,959	14,377	9,231	20,007	37,145	44,972
	Net (a)-(b)	(6,857)	(8,638)	(6,295)	(11,328)	(3,503)	(5,796)	(1,778)	(323)	(13,360)	(29,986)	(40,019)
2nd Regional banks	Sell (a)	2,146	3,249	4,607	3,833	4,057	4,104	2,628	2,571	2,910	4,716	4,899
	Purchase (b)	3,467	6,498	7,265	5,451	5,435	5,232	3,191	5,007	5,444	7,563	6,958
	Net (a)-(b)	(1,321)	(3,248)	(2,658)	(1,618)	(1,378)	(1,128)	(564)	(2,436)	(2,534)	(2,846)	(2,059)
Shinkin Banks	Sell (a)	6,623	7,587	9,830	9,086	9,157	7,002	4,571	7,170	9,997	9,963	15,361
	Purchase (b)	14,580	18,497	19,282	15,909	17,940	24,217	15,279	26,889	30,588	31,911	28,825
	Net (a)-(b)	(7,957)	(10,910)	(9,453)	(6,824)	(8,783)	(17,216)	(10,708)	(19,719)	(20,590)	(21,947)	(13,464)
Other Banks and Fin.Insts.	Sell (a)	22,587	14,429	16,169	41,274	18,830	16,404	19,375	26,341	22,250	12,586	11,642
	Purchase (b)	35,805	24,173	32,545	68,761	50,153	38,933	48,635	62,832	54,833	45,359	44,382
	Net (a)-(b)	(13,218)	(9,745)	(16,376)	(27,487)	(31,323)	(22,529)	(29,259)	(36,491)	(32,583)	(32,773)	(32,740)
Life and property casualty insurance companies	Sell (a)	22,188	22,320	18,690	14,807	13,802	12,556	13,684	14,076	16,805	9,539	13,642
	Purchase (b)	32,928	38,219	25,015	19,879	22,515	20,255	22,090	23,485	29,140	26,968	28,216
	Net (a)-(b)	(10,741)	(15,899)	(6,325)	(5,072)	(8,713)	(7,698)	(8,405)	(9,409)	(12,335)	(17,429)	(14,574)
Investment trust	Sell (a)	8,569	9,971	5,266	7,140	5,828	4,338	5,529	6,210	7,108	4,833	4,615
	Purchase (b)	39,639	47,235	26,384	27,766	26,171	28,313	28,238	25,992	22,088	23,730	24,216
	Net (a)-(b)	(31,070)	(37,264)	(21,118)	(20,626)	(20,343)	(23,976)	(22,709)	(19,782)	(14,981)	(18,896)	(19,601)
Public employees mutual aid associations	Sell (a)	2,620	1,060	864	794	1,529	1,631	1,288	877	880	612	515
	Purchase (b)	2,365	2,243	1,841	6,535	7,235	7,542	6,930	6,983	5,469	3,065	2,596
	Net (a)-(b)	255	(1,183)	(976)	(5,741)	(5,706)	(5,911)	(5,642)	(6,107)	(4,589)	(2,453)	(2,081)
Business corporations	Sell (a)	696	800	828	906	647	1,033	935	851	1,133	255	494
	Purchase (b)	4,100	3,514	6,514	7,225	8,849	8,125	11,230	10,453	9,996	12,759	13,894
	Net (a)-(b)	(3,404)	(2,714)	(5,686)	(6,319)	(8,203)	(7,092)	(10,295)	(9,602)	(8,862)	(12,504)	(13,400)
Other Corporations	Sell (a)	1,738	1,144	1,499	1,185	1,433	1,301	982	814	927	1,034	1,870
	Purchase (b)	5,579	4,967	4,599	4,598	4,652	5,334	7,659	6,240	5,929	5,626	6,162
	Net (a)-(b)	(3,841)	(3,824)	(3,099)	(3,413)	(3,220)	(4,033)	(6,677)	(5,426)	(5,002)	(4,591)	(4,293)
Non-resident investors	Sell (a)	50,664	46,886	49,105	58,329	71,436	86,480	99,016	122,127	103,251	91,808	99,307
	Purchase (b)	78,813	58,359	69,839	82,909	110,803	119,945	149,582	180,207	185,088	176,542	211,437
	Net (a)-(b)	(28,149)	(11,473)	(20,734)	(24,580)	(39,367)	(33,465)	(50,565)	(58,079)	(81,836)	(84,734)	(112,129)
Individuals	Sell (a)	661	650	719	621	610	471	328	303	322	492	629
	Purchase (b)	2,532	2,326	2,535	1,345	1,241	936	1,008	702	632	388	283
	Net (a)-(b)	(1,871)	(1,676)	(1,816)	(724)	(632)	(465)	(681)	(399)	(310)	104	345
Others (BOJ and Government sector + related agencies)	Sell (a)	191,371	225,165	258,436	291,187	357,108	313,203	334,295	334,439	358,574	437,704	403,892
	Purchase (b)	32,661	102,663	104,537	114,136	118,786	110,883	123,337	114,014	99,983	95,594	97,911
	Net (a)-(b)	158,711	122,502	153,898	177,051	238,322	202,320	210,957	220,425	258,591	342,109	305,981
Bond dealers	Sell (a)	590,923	585,148	612,515	724,262	788,988	755,991	874,516	978,710	868,471	842,434	908,691
	Purchase (b)	592,413	583,680	613,989	724,235	785,890	753,012	872,644	974,208	870,291	844,919	905,541
	Net (a)-(b)	(1,490)	1,469	(1,474)	27	3,098	2,979	1,872	4,503	(1,820)	(2,485)	3,150
Total	Sell (a)	1,030,225	1,053,564	1,171,180	1,323,896	1,454,252	1,378,873	1,539,328	1,739,578	1,622,784	1,649,462	1,728,243
	Purchase (b)	1,038,697	1,081,492	1,184,705	1,359,855	1,481,338	1,425,804	1,548,812	1,739,219	1,638,304	1,662,656	1,746,602
	Net (a)-(b)	(8,472)	(27,928)	(13,525)	(35,960)	(27,086)	(46,931)	(9,484)	359	(15,520)	(13,194)	(18,359)

Notes: Figures exclude those of gensaki transactions.

Source: The Japan Securities Dealers Association.

C. Over-the-Counter Trading of Bonds

Majority of bond transactions take place OTC rather than on exchanges; secondary market is dealer-driven market instead of order-driven trading on the stock exchange. This dealer-driven status is due to the following reasons:

1. There are so many issues of bonds that it is practically impossible to list all of them on exchanges;
2. Due to the wide variety of transaction forms and other specifications that different buyers and sellers require, it is difficult to instantly locate a matching counterparty for a particular transaction;
3. Tax on bond interest varies according to the tax profiles of bondholders; and
4. Corporate investors, who account for the bulk of the bond trading volume, tend to trade in large lots and often carry out complex transactions involving more than one issue.

On account of these reasons, bond transactions do not lend themselves to trading on exchanges, where the terms of transactions need to be standardized. Bonds are rather more effectively traded over the counter, where trades are executed based on the terms individually negotiated between buyers and sellers. The Tokyo Stock Exchange (TSE), the Osaka Securities Exchange (OSE), and the Nagoya Stock Exchange (NSE) have bond trading facilities, but very few issues, except for JGBs and convertible bonds, are listed there.

The new TOKYO PRO-BOND Market will provide the bond issuers a disclosure and registration (listing) place for bonds and MTNs for professional investors with maintaining the OTC trading environment.

D. Publication of Reference Statistical Prices for Over-the-Counter Bond Trading

1. Historical Background

As OTC bond trading is a negotiated process between a securities company and a client, it is difficult for a third party to discover the price at which a transaction is consummated. Publication of prices and other information concerning OTC bond transactions not only helps efficient and orderly trading of bonds but is also of critical importance from the standpoint of investor protection by promoting the formation of fair prices and facilitating investors' access to trading at the best possible price. Publication of bond prices is thus indispensable for the development of bond markets.

With a view to providing investors, securities companies and others with reference information, the Japan Securities Dealers Association (JSDA) instituted the system for publishing the "Reference Statistical Prices (Yields) for OTC Bond Transactions." Under the system, JSDA receives the quotation information from a certain number of designated reporting members (securities companies and banks) and publishes the average price, median price, and highest and lowest prices after excluding certain outliers (each price representing midpoint of ask and bid which the designated reporting members intend to quote) in each issue of publicly offered public sector and corporate bonds that meet certain criteria.

The program was originally instituted in August 1965 by the Bond Underwriters Association of Japan for publishing “OTC Quotes for Industrial Debentures” and was succeeded by the Tokyo Securities Dealers Association, the predecessor of the JSDA, which began the publication of “OTC Quotes for Public and Corporate Bonds” in March 1966. The initiatives were implemented with a backdrop of social necessity to promote the formation of fair prices and efficient and orderly trading for JGBs, issuance of which had been resumed after World War II. The program has since undergone many changes and improvements in response to the changing environment surrounding the bond market. During that period, the number of published issues has ballooned from about 300 when the system was introduced, to approximately 6,200.

In August 2002, the JSDA changed the name of the data to “reference prices (yields)” from “standard quotes” with the intent to clearly indicate that it is for reference purposes. At the same time, the program was enhanced by publishing “high, low, and median values of surveyed quotes” in addition to their averages, which was the only data previously published. That system continues today.

The program started publishing bond quotes 40 years ago, and it is fair to say that it has since made measurable contributions by providing benchmark prices for OTC bond trading in Japan. The use of data is no longer limited to price references for trading bonds but serves a wide variety of public purposes, including mark to market valuation for financial reporting and tax accounting purposes and the valuation of collateral for different types of transactions.

2. Improvement of Infrastructure for Disseminating Bond Price Information

- a. As mentioned above, JSDA manages the system of “Reference Statistical Prices (Yields) for OTC Bond Transactions” (hereinafter referred to as the “Reference prices”) as an infrastructure of corporate bond price information. These Reference prices are widely used by investors and market participants, and are indispensable infrastructure in the financial and securities markets. For example, they are used as a reference purchase or sell price of corporate bond, for the fair value appraisal as a pledge, for the calculation of base price of investment trusts, and as a reference price and indicator at the time of determining the issuance conditions for corporate bonds.
- b. However, as the Reference price sometimes diverges from the actual price (such as the execution price and the bid offer) and has a time lag, it is pointed out that we need to review and improve the system.
- c. JSDA and market participants are considering the following based on the system in the U.S., the United Kingdom and the Republic of Korea to improve the transparency of bond price information and build credibility for the information.
- d. At present, JSDA does not have access to actual price data information on a daily basis. However, JSDA has been making representations in the deliberation of the “Study Group to Vitalize the Corporate Bond Market” (Group 4) that, in line with practices in many other markets in the Association of Southeast Asian Nations plus the People’s Republic of China, Japan, and the Republic of Korea (ASEAN+3), actual traded price information should be more useful as a source of bond price dissemination. The debate on this point is still underway.

3. Publication of Transaction Price

- a. For the time being, JSDA publishes the transaction price once a day after the trading hour finishes for issues with high liquidity. For the next stage improvement, JSDA and market participants are discussing how to expand the frequency, timeliness, and coverage based on the transaction volume and other factors;
- b. JSDA will maintain the anonymity of investors (people who made transactions);
- c. JSDA will reduce the cost of securities companies, banks and other users by using an existing system such as the one operated by the Japan Securities Depository Center, Inc. (JASDEC).

4. Improvement of Credibility of the Reference Price

To improve the credibility of the Reference price, JSDA and market participants may consider the following ideas and implement them:

- a. Review the designated reporting member system
 - i. Publicize the name of the designated reporting members;
 - ii. The designated reporting members shall be Association members who are capable of executing the transaction;
- b. Putting off the reporting deadline

Consider putting off the reporting deadline and the publication timing for the purpose of ensuring the credibility of calculation of the Reference price by the designated reporting members in cooperation with the market participants and users.

c. Others

JSDA and market participants will continue to exert efforts to improve the transparency of bond price information and build credibility for the information.

E. Secondary Market Yields and Terms of Bond Issues

Generally, the yields at the new issue of particular types of bonds have come in line with yields of their comparable bonds. And, those yields level are also affected by the amount of new issues and secondary market trading volume.

1. Efforts in the Government Bonds Market

Amid the continued massive issue of government bonds, the proportion of bond issuance through public auctions that more closely reflect market conditions has steadily increased under a market-oriented national debt management policy. This replaced the previous emphasis on non-competitive, syndicated underwriting, where issue terms were based on the official discount rate or other benchmarks.

As far as the 10-year JGB is concerned, during a long period of time, the syndicated underwriting system, which is a non-competitive (conventional) system, has been maintained until the underwriting syndicated system was abolished in 2006. In contrast, for government bonds of other terms, over a period of a substantial length of time before 2006, they have been issued as determined by the tender or auction conditions, which is the so-called “Partial price competitive tendering system.”

Over a considerable long period of time, market participants and government officials have been making efforts to realize a fair market price formation. Currently, in principle, all government bonds are issued through auctions (the syndicated underwriting program for JGBs was discontinued in March 2006). The market-oriented transition of bond issuance has also been witnessed in pricing spreads among bonds with different credit qualities. For example, yields at the issue of government-guaranteed bonds and local government bonds were determined in reference to the yield at issue of 10-year JGBs that had been issued earlier in the month. From time to time in the past, the spreads of issues among these three classes of bonds deviated from market spreads. In recent years, however, as investors started to focus more on differences in credit quality, the spreads of issues among the three classes have increasingly tended to move more in line with credit spreads prevailing in the market.

Another case in point that demonstrates the increased market orientation in bond issuance is the growing portion of government-guaranteed bonds, which is now issued through a competitive bidding process (as individual issues). Investors are also showing an increasing tendency to differentiate corporate bonds based on credit ratings by rating agencies and other factors. In response to this, many issuers go through a pre-marketing process to identify and estimate investors' demand and determine the terms of issue accordingly.

2. Efforts in the Corporate Bonds Market

In the corporate bond market, determining the method of the issuing condition has been developed over the past 2 decades.

a. Proposal Method

In the corporate bond market, the proposal method was launched in 1988 based on the recommendation of the Securities and Exchange Committee of the Ministry of Finance (MOF) at that time to abolish permanent fixed-member syndicate and introduce free competition among securities firms. Under the proposal method, the issuer, taking account of relationship to a certain extent, selects a lead manager mainly based on proposed issuing price for issuer's requesting terms and conditions. This method worked based on the terms and conditions presented by the issuer. Accordingly this method had the strong features of competitive bidding.

The proposal method, however, soon collapsed because it created intensified competition among securities firms to win the lead manager position, and fair pricing was less focused because none of issuers or investors could confirm fair pricing due to undeveloped and illiquid secondary market conditions. Trustworthiness and confidence on pricing offered by the lead manager caused serious doubts in all the cases.

b. Negotiated Method

In 1991, Nippon Telegram and Telephone (NTT) dropped the proposal method and introduced new method to appoint lead manager(s). Even under the immature, undeveloped bond market, (for some reason) even though the secondary bond market liquidity has been declining at that time, it was necessary to seek for fair pricing. In order to achieve fair pricing, "the JGB spread pricing new issue under the negotiated method" plus "the Fixed Price Reoffer with Syndicate break for launching (released

to the syndicate selling group with the uniform fixed reoffering price) method” were developed and introduced in the corporate bond primary market.

Under the new negotiated method, NTT has not requested pricing indication from any securities firm since then. Instead, they put heavy weight on the proposal of a new issue strategy and commitment on secondary market maintenance in the selection of lead manager(s). As for new issue pricing, they emphasize discreet price discovery and decent book-building process after mandating lead manager(s).

This new scheme aims for fair pricing to reflect accurate investors’ demands under the prevailing market. For that purpose, the JGB Spread talk with investors was introduced to find out appropriate price as the benchmark to clear target issue amounts. Then, the corporate bond issue shifted to flat-sales price system.

After several years, utilities companies, general business corporations, and some public sector entities adopted the similar scheme.

This method cannot be allowed to discount sales; sales prices reflect the prevailing market conditions.

Since then, many issuers, for realizing the fairer market pricing, have been trying various methods.

F. Repurchase (Gensaki) Market for Bonds

A repurchase agreement (a conditional purchase or sale) is a form of trading between a seller and a buyer of debt securities whereby the seller (or the buyer) agrees to repurchase (or resell) the securities at an agreed price at a stated time. When the holder of bonds sells them to a buyer under an agreement to buy them back (a gensaki sell transaction), the holder can raise funds temporarily.

When an investor buys bonds from a seller under a repurchase agreement to sell them back to the seller (a gensaki buy transaction), the investor can earn a certain amount of interest by investing funds for a short period. When a securities company acts as an intermediary and arranges a repurchase agreement by introducing a buyer who wants to invest idle cash in bonds to a seller who wants to raise funds by selling bond holdings, such a deal is called a brokered repurchase agreement. When a securities company in need of short-term cash sells bonds out of its inventory to an investor under a repurchase agreement, it is called a proprietary repurchase agreement.

As the repurchase (or resale) price includes an amount equivalent to a return on investment or financing charge based on an agreement by the buyer and seller, the price does not usually tally with the prevailing market price of the bond at the time of its repurchase (or resale). Repurchase agreements can also be concluded for CP and certificates of deposit (CDs), and CPs issued overseas.

As gensaki transactions conveniently meet the short-term funding and cash management needs of investors, their trading volume has increased steadily along

with the BOJ's lifting of quantitative easing measures and other factors until the 2007–2008 financial crisis.

Figure 3.3 Outstanding of Bond Transactions with Repurchase Agreements, January 2001 to September 2011 (¥ trillion)

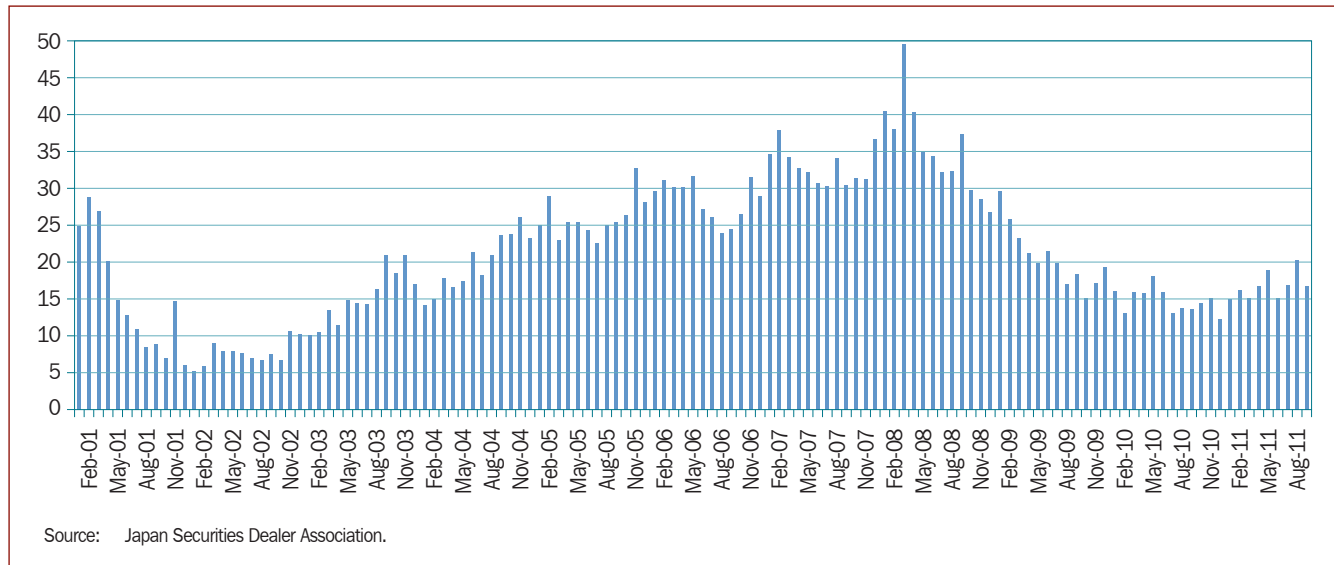

In the past, majority of gensaki transactions were for short-term government securities (TBs, FBs, and T-bills). Despite intensifying competition against other increasingly diversified money-market instruments, these government bills have dominated the gensaki market, as the bills, which have maturities and credit quality more suitable for gensaki transactions, have been increasingly issued to the public.

Although the gensaki market developed against the backdrop of this expansion of short-term government securities market, interest-bearing JGBs have taken center stage since late 1990s, partially because of the massive overall issuance of government bonds. In an effort to modernize and strengthen the international competitiveness of Japan's money market, the gensaki market underwent a reform to improve its functions as a repo market that facilitates the need for both short-term financing and bond borrowing, and thus was called new gensaki transactions started in April 2001. Up to that point, gensaki transactions were bought and sold much like the transactions commonly known as repo trades in the U.S. and Europe but had various shortcomings that necessitated reform. In particular, the gensaki market did not have functional risk management facilities or standard rules for dealing with counterparty default. Through this reform, new measures were instituted and existing provisions were enhanced for risk management and other purposes, establishing the gensaki market in accordance with global standards. The newly introduced provisions for risk management and other purposes (clauses in the repurchase agreement) may be summed up as follows:

1. Risk Control Clause

The amount of collateral (bonds) shall be adjusted flexibly so as not to cause a shortage of collaterals on account of a fall in the price of bonds submitted as collateral.

a. Application of the Ratio for Computing the Purchase/Sale Value of Bonds (The Haircut Clause)

Under this clause, the unit price of bonds (collateral), on the basis of which a repurchase agreement is concluded is fixed at a level that is a certain percentage point lower than the price prevailing at the time the repurchase agreement is concluded. This is done so that the value of the collateral will not be affected even when market price of the underlying bonds falls.

b. Introduction of Management of Collateral (The Margin Call Clause)

Under this clause, when the market value of the underlying bonds changes during the period of the repurchase agreement, the amount of credit extended to a party to the repurchase agreement is maintained by adjusting the collateral.

c. Introduction of the Repricing System

In instances when the market price of the underlying bonds falls sharply from the prevailing market price at the time of the repurchase agreement, the parties to the agreement agree to cancel the agreement and renegotiate a new agreement on the basis of a price then prevailing, on terms and conditions identical to those of the agreement thus canceled.

2. Substitution of Underlying Bonds

Under this clause, the seller of bonds can replace the underlying bonds with other bonds with the consent of the buyer, allowing the seller to use the underlying bonds, if necessary.

3. Institution of Netting-Out System

If the other party goes into default for any reason, such as bankruptcy, the value of all transactions covered by the agreement will be re-assessed based on market prices, and the difference between claims and obligations will be settled.

G. Bond Lending

When investors have shorted bonds (or sold bonds that they do not own) and failed to buy them back before the settlement date, they turn to bond lending services to borrow bonds to deliver. Such transactions are also known as saiken repo (bond repos) in Japan.

When cash is used as collateral, bond lending is economically equivalent to gensaki transactions. Since market participants can obtain bonds through bond lending facilities after trades are consummated, they can sell bonds that they do not own (sell short) when they feel that the bond market is too expensive or particular issues are overvalued. Such operations contribute to greater liquidity in the market.

Bond lending was instituted by legislation in 1989, following the lifting of the practical ban on bond short selling. In fear of potential effects on the financial health of brokers and dealers and bond pricing, market participants had previously been requested to refrain from selling bonds short. The ban, however, was lifted to help encourage active market making in cash bonds, and arbitrage between cash bonds and futures, and bond borrowing and lending was introduced as one of the means to locate bonds to deliver.

Initially, cash-collateral bond borrowing and lending was restricted in light of potential conflicts with the gensaki market and other considerations, and, subsequently, most transactions were uncollateralized. However, with credit fears rising, the bond lending market remained stagnant, and cash collateral bond borrowing and lending transactions were effectively deregulated in 1996 to invigorate the market.

When viewed from a legal standpoint, a bond lending transaction is deemed to be a “contract for a loan for consumption,” i.e., a borrower borrows bonds for the purpose of consumption and, when due, the borrower has only to return bonds identical in kind and quantity with those originally borrowed.

Bond lending transactions may be broadly classified into “unsecured transactions” and “secured transactions” depending on whether they are collateralized or not. Secured bond lending transactions may be further divided into “cash-collateralized transactions” and “securities-collateralized transactions” by the type of collateral being pledged. Cash-collateralized transactions used to borrow specific bond issues are called specified collateral (SC) torihiki (specified collateral trades), while those for financing and cash management without such specification are termed general collateral (GC) torihiki (general collateral trades).

The size of the bond lending market (in terms of the balance of outstanding loans) has generally been growing since cash-collateralized transactions were deregulated in 1996. The market has grown from approximately ¥30 trillion at the end of fiscal 1996 (including approximately ¥17 trillion in cash-collateralized transactions) to ¥106 trillion at the end of fiscal 2008 (including approximately ¥97 trillion in cash-collateralized transactions). Since then, after the financial crisis, the recent balance is ¥72 trillion at the end of September 2011 (including approximately ¥70 trillion in cash-collateralized transactions).

Majority of bond lending transactions are conducted with government securities.

Table 3.2 Bond Lending Balance as of 30 September 2011 (¥ trillion)

	Borrowing Balance	Lending Balance
City banks	57,790	24,951
Regional banks	7,052	785
Trust banks	183,668	110,870
Financial Institutions for Agriculture and Forestry	9,266	22,030
2nd Regional banks	935	0
Shinkin banks	2,931	0
Other financial institutions	60,923	50,690
Life and Non-Life Insurance	32,129	3,560
Investment trust	0	1,461
Mutual Aid Association of Government Offices	0	0
Business corporations	2	42
Other organizations	60	8
Non-resident	16,132	10,223
Others	100,257	124,654
Bond dealers	249,814	371,685
Total	720,959	720,959
Collateralized portion	695,769	695,769
Note : 1 Figures are based on reports by all members of JSDA. 2 Trading in financial account is not included.		
Source: Japan Securities Dealer Association.		

H. Proprietary Trading System for Fixed-Income Securities

1. Overview

The revision of the *Securities Exchange Law* in December 1998 led to the birth of Proprietary Trading System (PTS). The Financial Services Agency (FSA) announced the PTS guidelines in November 2000. According to the guidelines, although PTS operators are highly regulated by FSA and are required to obtain an approval for PTS license, some entrepreneurs and innovators have launched the electronic trading systems. Unlike stock trading, as bonds are traded mostly OTC, the needs for improving transparency, efficiency and accuracy in trading have been strong. It became stronger in the past several years due to the increase in compliance and/or governance requirement. PTS was supposed to be ideal to enhance the governance in trading. In reality, however, PTS has not been very successful in Japan, and it still has a long way to go.

2. Inter-Dealer Broker and Broker-to-Customer Market

There are two types of PTS operators: broker-to-broker (B-to-B, or inter-dealer broker [IDB] market) and broker-to-customer (B-to-C, institutional investor market).

a. Inter-Dealer Broker Market

The IDB market adopted the PTS promptly. The main operator of the IDB market is the broker's broker (BB), which in this case is Nihon Sogo Shoken. ICAP Totan Securities Co. Limited and Central Tanshi followed the IDB market.

BB has been active in e-trading and its PTS operation while other brokers have been lagging far behind BB. It is estimated that BB trades comprise 80% of the trade volume through PTS.

b. Institutional Investor Market

The B-to-C market has developed in a very different manner from the IDB market. There have been two main players in this market—JBOND and Yensai.com.

JBOND was founded in April 2000. It started the operation in June 2001 as a quotes-comparison site. Eventually, JBOND became a securities company in September 2002 and received its PTS license in October 2002. Since then, the company operated the JGB PTS by gradually adding market makers and institutional investors.

Yensai.com was founded in January 2001 by seven major securities dealers following the business model of TradeWeb. It received its PTS license in March 2002. TradeWeb, a dominant player in the U.S. and Europe, was rather slow to enter the Japanese market. It received its PTS license in 2005 to trade foreign bonds. Trading of Japanese bonds was added as late as 2008.

Bloomberg also has a PTS license but its system is a gateway to lead an inquiry into a certain dealer or broker. It is not regarded as a fully-fledged multi-dealer system provider.

FSA has encouraged asset management companies to adopt a trader-system, where dealers concentrate on dealing and fund managers focus on portfolio management. These FSA guidelines encouraged dealers to use electronic trading (e-trading) more often. At the same time, due to increased compliance needs, investment management companies with fiduciary responsibility have been required to obtain several quotes before a trade is done to ensure the best executions. Investors have started showing interest in PTS platforms gradually.

Still, the combined share of all the PTS players is estimated to be less than 5% in the JGB wholesale market. The JGB PTS market is still negligible in terms of trade volume.

c. Inter-Dealer Broker versus Broker-to-Customer Market

As mentioned above, e-trading has grown in the IDB market in a short period of time but the B-to-C market has demonstrated very slow growth. The reason for this is not clear but this has been attributed to differences in trading attitude. Market makers want to know why investors are selling or buying in order to see where the market is heading. One of the important responsibilities of bond sellers is to find out investors' thinking and behavior. Thus, they call investors incessantly and provide the information back to dealers, which will be the basis for dealers in building up their positions. On the other hand, the IDB market is the place for squaring positions. The brokers' task is to match the trades. Therefore, telephone conversations are not very important in the IDB market. As brokers do not lose much by switching to e-trading, they did not resist the change much.

3. Pricing Method

FSA's guidance provides five pricing methods, which are:

- a. **Market Price-Trading Method.** This method uses current prices and quotes on the stock exchanges.
- b. **Direct-Negotiation Method.** This method uses a price negotiated between customers. It is often called “negotiation method,” and sellers and buyers negotiate the price, volume, settlement date and other conditions. As this method is similar to the way bonds are traded over the phone, all the PTS operators in the B-to-C market have adopted this method.
- c. **Order-Matching Method.** Under the order-matching method orders from customers are matched with each other. A trade is done when an order from a buyer and a seller is matched. PTS operators provide the screen where buyers and sellers put in their orders. Counterparties who wish to trade will click orders and trades are done. As the monitor screens are similar to the ones that IDBs use, IDB PTS operators use this method. The JBOND Repo System also adopted this method.
- d. **Quote-Driven Method.** In the quote-driven method market makers show their quotes and stand ready to trade with customers. It is often called the market-making method. Market makers show their bids and offers for bonds they wish to trade. They are not obliged to show the quotes for all the bonds and, in case of Yensai.com, securities dealers must confirm the trade before it is done. Therefore, this click-and-trade quote-driven method is not popular among institutional investors.
- e. **Auction Method.**

For bonds PTS only (b), (c), and (d) are applicable.

4. Facilitators

a. Yensai.com

Yensai.com was founded by seven major securities dealers in January 2001 and its PTS operation started in 2002. It differentiated from other PTS facilitators with major Japanese market makers. It provides two types of trading method—real-time order system (a quote-driven system) and inquiry system (an order-driven system). Real-time order system shows all the bids and offers for JGBs with tradable amounts on the side. This click-and-trade system looked handy and attractive, but in reality, the usage has been pretty limited. Most users look at the monitor screen to find out the current yield curve, and not to do trades. As securities dealers did not feed the best prices, investors used the bid/offer prices as indication.

The order-driven system, on the other hand, has been relatively successful.

Currently, there are 13 securities dealers who participate as market makers for all interest-bearing JGBs.

b. JBOND

JBOND, another PTS operator, was founded in April 2002 and began its PTS operation in November 2002 and started the service before Yensai.com. It started its repo PTS in October 2009. Its participating market makers were mainly foreign banks.

JBOND has shifted the focus from JGB outright trades to JGB repo market in June 2010. It is the first and only PTS player for repo e-trading. Its users are limited to the Japan Government Bond Clearing Corporation (JGBCC) members. It is still early to determine if it would take off in Japan. BB runs the similar system but it does not operate as PTS.

c. TradeWeb

TradeWeb, a dominant player in the U.S. and Europe, was rather slow to enter the Japanese market. It was founded in 2004, received its PTS license in 2005 and started trading Japanese bonds in 2008. About 10 broker-dealers are participating but the activities are rather limited.

d. Bloomberg

Bloomberg also has a PTS license but its system is a gateway to lead an inquiry into a certain dealer-broker. However, it does not have significant influence in the market.

IV. Bond Market Infrastructure

A. Bond Market Infrastructure Diagram and Business Process Flowchart

Figure 4.1 Bond Market Infrastructure Diagram

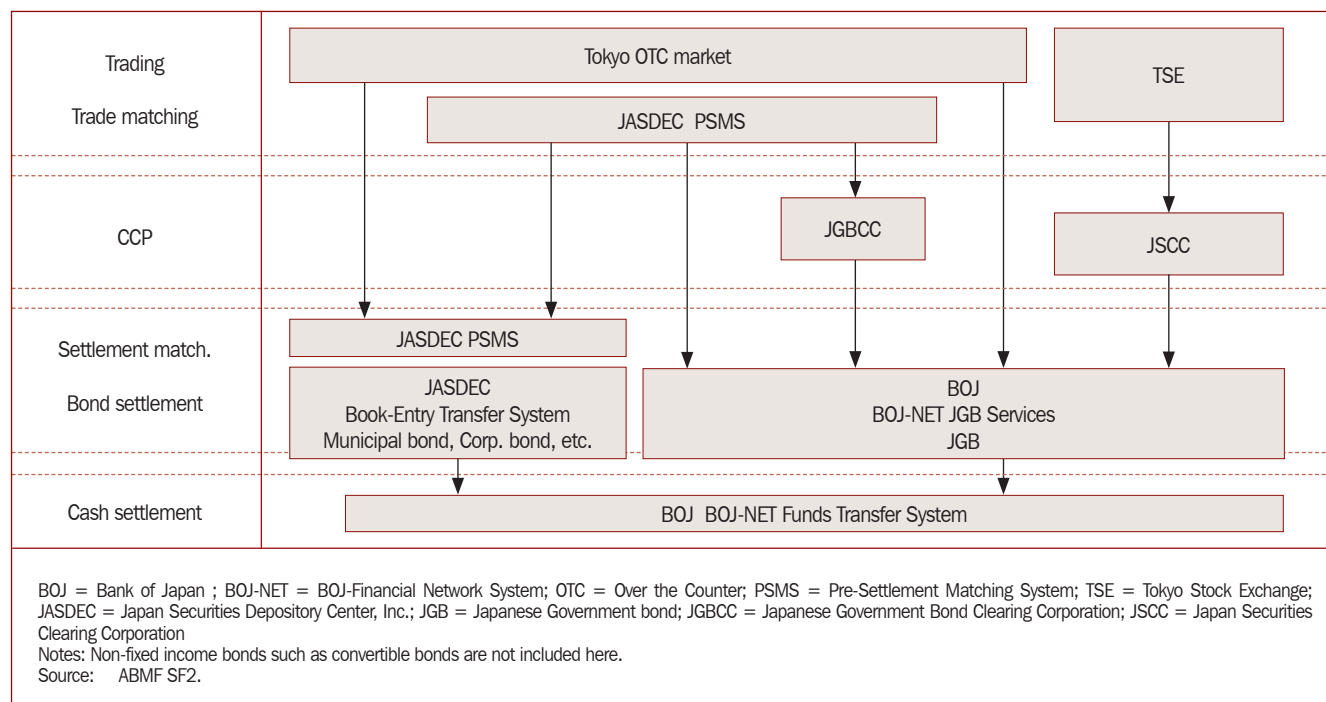
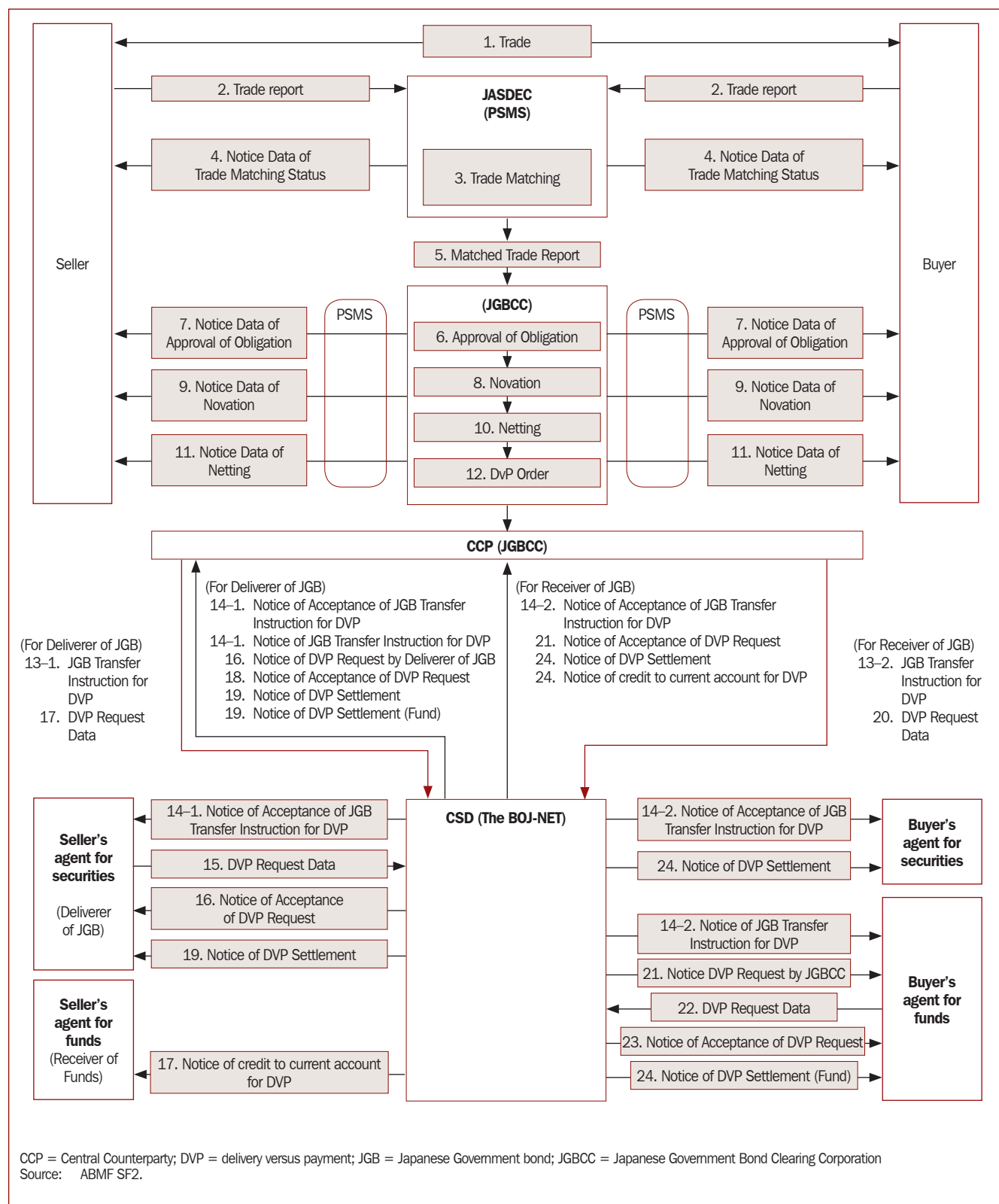
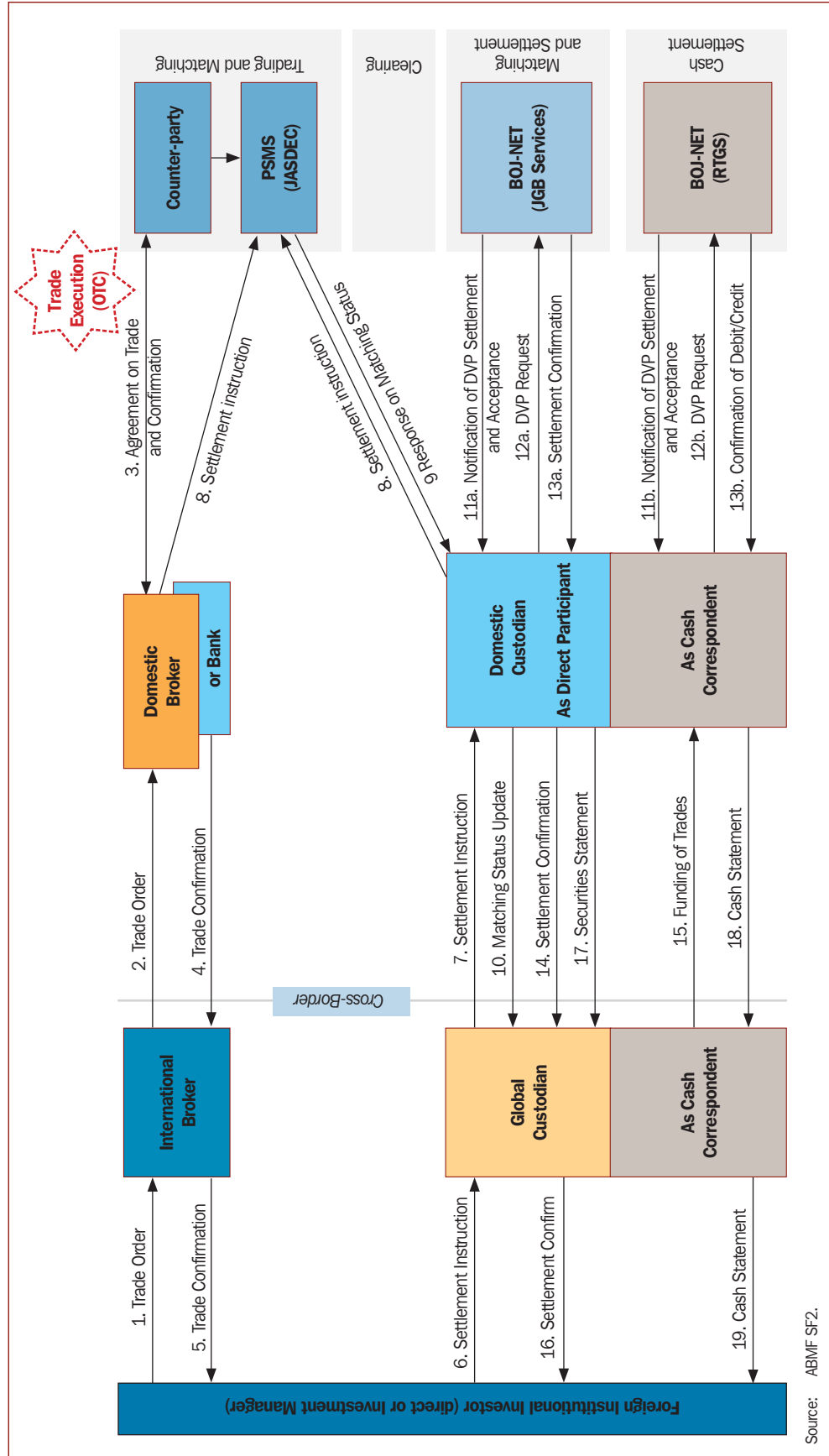

Figure 4.2 Business Process Flowchart: Japanese Government Bond Market/Delivery versus Payment with Matching and Central Counterparty



B. Over-the-Counter Bond Transaction Flow for Foreign Investors (Including Cross-Border, Funding, and Reporting Components)

Figure 4.3 OTC Bond Transaction Flow for Foreign Investors



1. Description of Steps in the Over-the-Counter Bond Transaction Flow for Foreign Investors

- (1) Foreign Institutional Investor places order with International Broker
- (2) International Broker places order with Domestic Broker/Bank
- (3) Domestic Broker/Bank trades over the counter (OTC) with Counterparty (via phone or e.g., Bloomberg)
- (4) Domestic Broker/Bank send trade confirmation to International Broker
- (5) Foreign Institutional Investor receives trade confirmation
- (6) Foreign Institutional Investor instructs Global Custodian on securities settlement details
- (7) Global Custodian instructs Domestic Custodian on securities settlement details
- (8) Domestic Broker and domestic Custodian input trade details into PSMS
- (9) Pre-Settlement Matching System (PSMS) responds with matching status
- (10) Domestic Custodian reports transaction status update to Global Custodian
- (11) Domestic Custodian/Direct Participant receive Notification of Delivery-Versus-Payment (DVP) Settlement and Acceptance from Bank of Japan (BOJ)-NET
- (12) Domestic Custodian/Direct Participant send DVP request to BOJ-NET
- (13) Domestic Custodian/Direct Participant as well as Japanese Government Bond Clearing Corporation (JGBCC) receive confirmation of DVP settlement
- (14) Domestic Custodian sends settlement confirmation to Global Custodian
- (15) Global Custodian funds account with Domestic Custodian, or into foreign currency (FCY) nostro (before end of day)
- (16) Global Custodian sends settlement confirmation to Foreign Institutional Investor
- (17) Domestic Custodian sends securities statement to Global Custodian
- (18) Domestic Custodian sends cash credit/debit confirmation in cash statement to Global Custodian
- (19) Global Custodian sends credit/debit confirmation in cash statement to Foreign Institutional Investor

V. Securities Settlement Infrastructure

A. Securities Settlement Infrastructure

1. Existence of Central Securities Depository and Book-Entry System for Debt Instruments

- a. BOJ acts as the Central Securities Depository (CSD) and provides book-entry transfer system for Japanese government bonds (JGB).
- b. Japan Securities Depository Center, Inc. (JASDEC) acts as CSD and provides book-entry transfer system for corporate bonds.

Figure 5.1 Securities Market Infrastructure in Japan

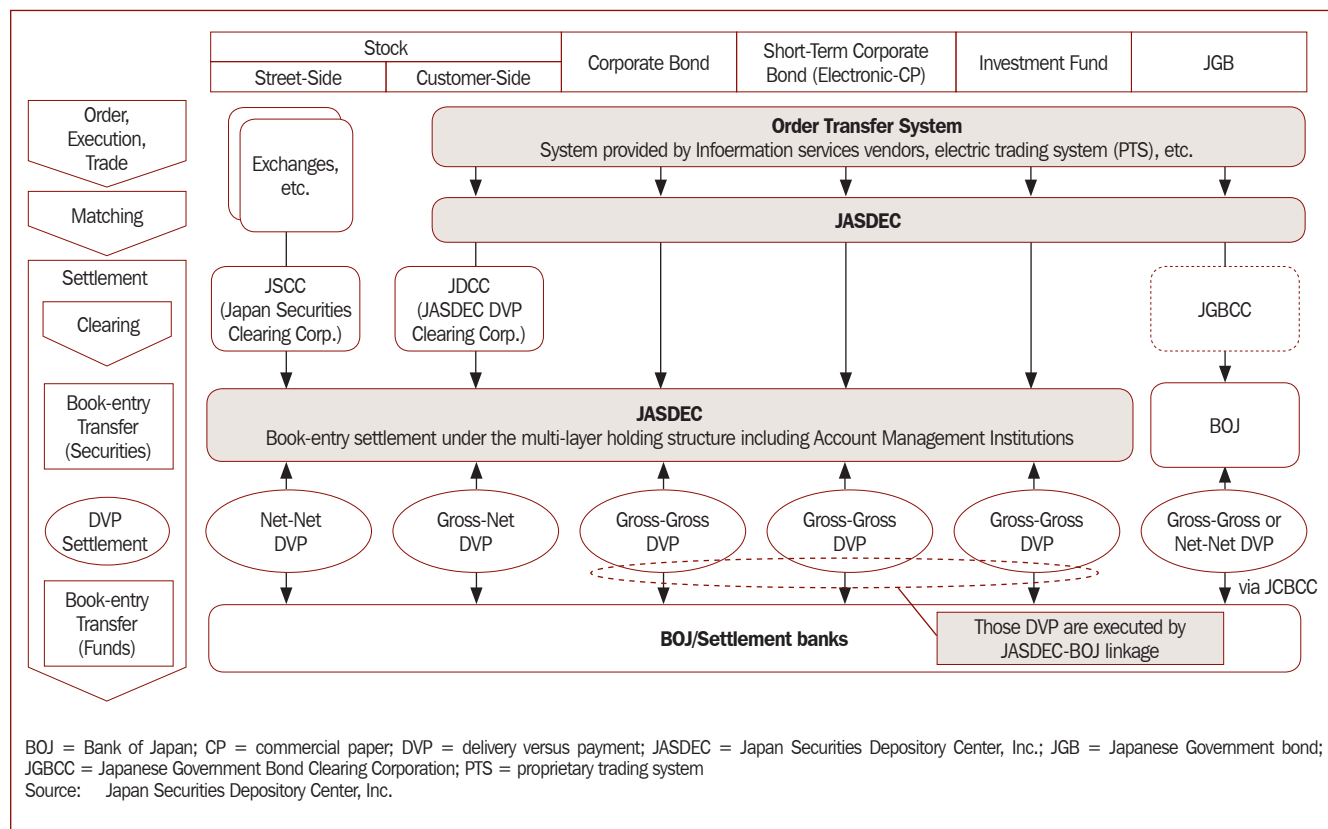

2. Features of Book-Entry Transfer System for Corporate Bonds

a. Complete Dematerialization

Issuers are able to issue in dematerialized form and investors are not allowed to request issuance of bond certificates. Reduction in issuance cost is expected, because no certificates are needed, including sample bond certificates and spare bond certificates.

b. Book-Entry Transfer System by Balance Management

Maintenance of smooth settlement has been possible with the introduction of book-entry transfer system. This enables right transfers by electronically recording the increase and decrease of the balance in the Transfer Account Book.

c. Multi-Layer Holding Structure

Multi-layer holding structure shall be composed of book-entry transfer institution, account management institutions (AMIs), and investors. AMIs can be positioned in a multi-layer holding structure to enable flexibility of business development for AMIs and affiliation among international institutions.

d. Delivery Versus Payment

Reduction of settlement risks has been improved due to DVP settlement, from issuance to redemption, including transfers.

e. Straight-through Processing

Business operation efficiency has been improved by linking with the pre-settlement matching system (PSMS), which realizes the straight-through processing (STP) from trade matching to settlement.

3. Eligible Securities of Book-Entry Transfer System for Corporate Bonds

1. Corporate bonds
2. Municipal bonds
3. Investment company bonds
4. Corporate bonds issued by mutual companies prescribed under the *Insurance Business Act*
5. Specified corporate bonds prescribed in the *Assets Securitization Act*
6. Rights that should be represented by bond certificates issued by companies under special law
7. Rights that should be represented by bond certificates issued by any government or by companies in foreign countries, such as Samurai Bonds.

4. Existence of Delivery-versus-Payment and Real-Time Gross Settlement Mechanism

- a. JASDEC provides securities transfer system, and BOJ provides fund transfer system. The DVP mechanism consists of both systems, which are related mutually.
- b. Under the DVP mechanism JASDEC records the increase or decrease in the balance of beneficial rights in the transfer account book after PSMS confirmation.

JASDEC's system is linked to the BOJ's Financial Network System (BOJ-NET) at the system level, enabling the use of DVP settlement, which involves executing the settlement of funds and recording the increase or decrease in the balance of beneficial rights in the transfer account book at the same time.

5. Existence of a Post-Trade Matching Mechanism

JASDEC provides PSMS for book-entry transfer system for corporate bonds (see Figures 5.2 and 5.3).

Figure 5.2 Japan Securities Depository Center, Inc. Book-Entry Transfer System for Corporate Bonds

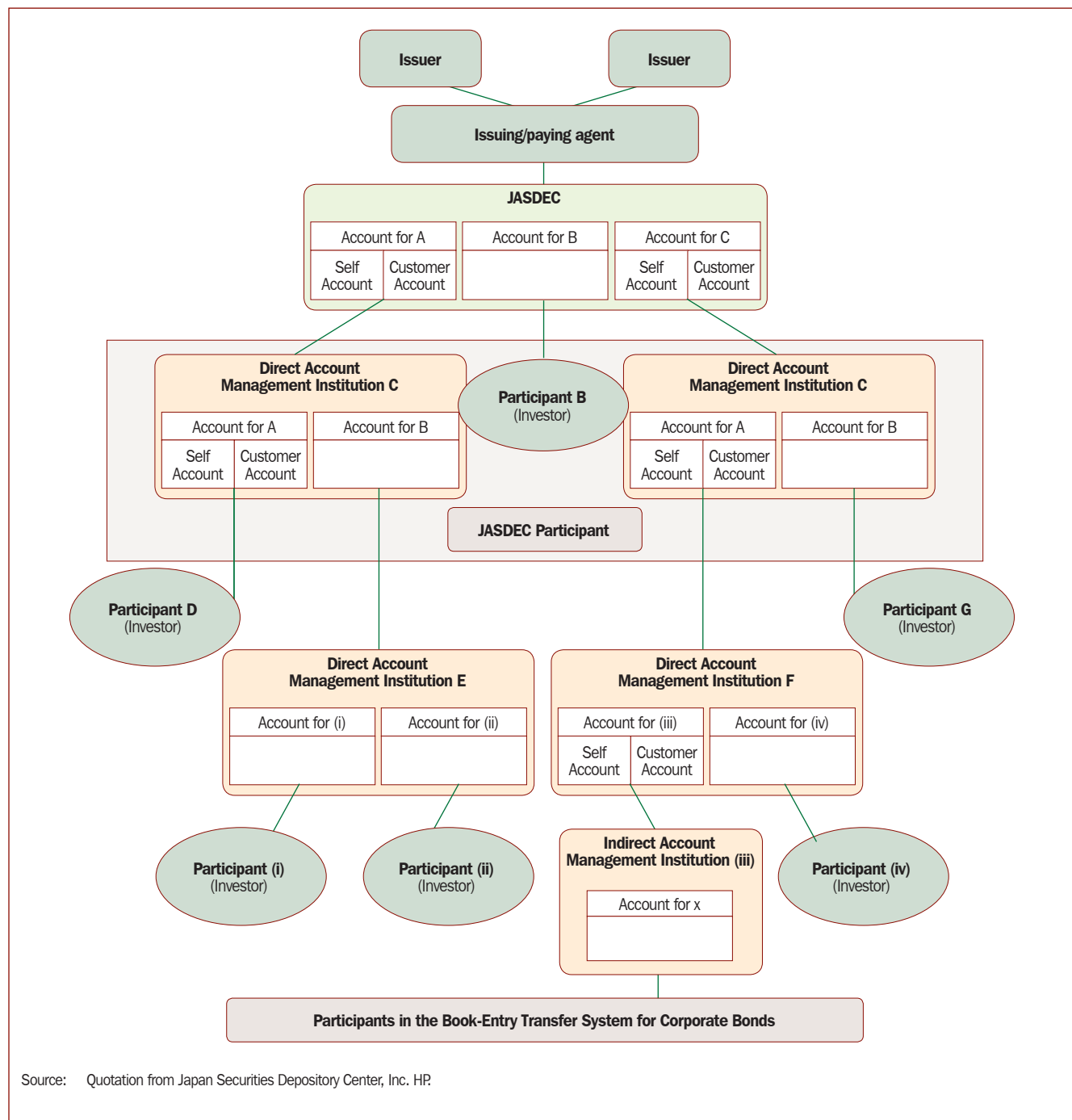

Source: Quotation from Japan Securities Depository Center, Inc. HP.

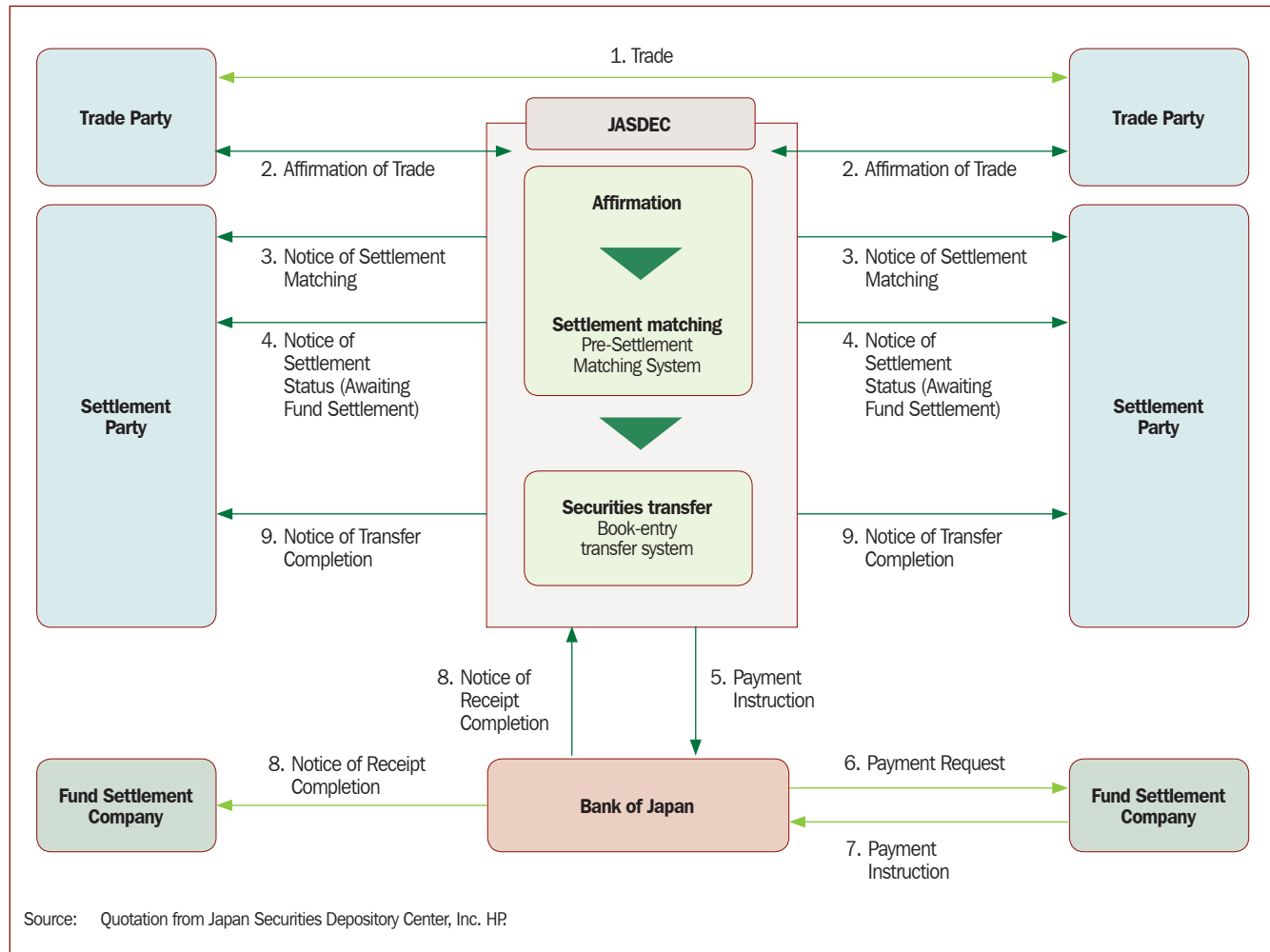
Figure 5.3 The Delivery-versus-Payment Mechanism

6. Existence of an Execution Matching Mechanism

JASDEC provides PSMS and securities transfer system as a set. The Settlement Party uses PSMS to instruct about securities transfer of corporate bonds.

7. Settlement Scheme (Gross-Gross, Gross-Net, Net-Net) for Commercial Paper, Corporate Bonds, Government Bonds and other Debt Securities

The settlement scheme of JASDEC for corporate bonds and commercial papers (CP) is Gross-Gross.

8. Settlement Cycle for Commercial Paper, Corporate Bonds, Government Bonds and Other Debt Securities

The settlement cycle is currently Trade Date + 3 days (T+3). The Working Group of the Japan Securities Dealers Association (JSDA) is now discussing about shortening of settlement cycle of JGB.

B. Challenges and Expected Changes

1. Issues on Current Settlement Infrastructures

Liquidity provisioning mechanism and liquidity-saving mechanism are currently lacking in JASDEC's book-entry system for corporate bonds.

2. Expected Changes on Settlement Infrastructures

- a. The CCP is expected to reduce of settlement risk and provide netting facilities.
- b. The realization of a liquidity-saving mechanism with the Next Generation RTGS of the BOJ-NET is expected.

C. Details of the Book-Entry Bond Transfer System

1. Book-Entry Bond Transfer System

Investors used to hold bonds in various forms, more specifically, in the form of physical certificates that had been issued by the issuer; in registered form, where bondholders were registered on the registry at the designated registrar for the issue; and as book-entry JGBs, where physical certificates were deposited with the BOJ so that trades could be settled by book-entry transfers (within a system established in 1980) among the accounts of brokers and other system participants.

In recent years, however, certificates that needed to be physically delivered or registered bonds, whose transfer required amendment in records of bond-specific registries, hardly stood the test of practical use with the increasing bond trading volume and a growing call for a flexible framework and an expedited process for the settlement of transactions. Meanwhile, the book-entry transfer system for JGBs had several shortcomings. This situation first led to the argument for the review of the settlement procedures for bonds at that time and, later, for the complete overhaul of the securities settlement system in Japan. There had been a growing perception that Japan urgently needed to rectify the existing system to create a safer and more efficient infrastructure that would make the country's securities markets globally competitive.

Against this background, the *Securities Settlement System Reform Law* was enacted in June 2002, and, pursuant to its provisions, the existing legislation for book-entry transfer was later amended and renamed the *Law Concerning the Book-Entry Transfer of Corporate Bonds and Other Securities*. Its objectives including the complete dematerialization of securities, shortening the settlement cycles, and the reduction in settlement risk. The amended law provided the legal framework for the new book-entry transfer systems for corporate and government securities. This law was further revised to the *Law Concerning Book-Entry Transfer of Corporate Bonds, Stocks, and Other Securities*.

On the basis of this framework, the BOJ improved the existing JGB book-entry system in January 2003, and JASDEC started operating a new central custody and book-entry transfer system for securities, including non-government bonds, in January 2006. These book-entry transfer systems have a multi-tier tree-like structure, with a central

custody and transfer agent—the BOJ for JGBs, treasury bills (TBs), and financing bills (FBs), and JASDEC for other eligible securities—on the top tier, from which account management institutions, securities companies, and other institutions with respective master accounts in the system and system participants; other securities companies and investors that have an account at one of the account management institutions cascade down as subsequent tiers or branches.

The bond holdings of system participants are registered or recorded in the transfer account book kept by the account management institution with which they have an account. In principle, all bonds are deposited with the central custody agency at the time of issuance, and the entire issue is dematerialized. None of those book-entry bonds may be withdrawn over their life in the form of either physical certificates or registered bonds.

The previously mentioned *Securities Settlement System Reform Law* also provided measures to affect the abolition of the *Corporate Bond Registration Law* following the set up of the book-entry transfer systems.

2. Development of a Securities Settlement System by the Japan Securities Depository Center

JASDEC (this term will also be used for the current Japan Securities Depository Center, Inc.) was established as a non-profit foundation on 6 December 1984 with the objective of streamlining the delivery of stock certificates. On 27 May 1985, JASDEC was designated as a depository under the *Central Securities Depository Law* (1984 Law, No.30) by the Minister of Justice and the Minister of Finance. It commenced depository services on 9 October 1991.

In the process of reforming the securities settlement system, there was growing debate on the corporatization of JASDEC. Given the pressing need for the reform of the securities settlement system in Japan, it became essential to build a securities settlement system which is globally competitive and convenient for market users. Thus, it became necessary to immediately develop a securities-clearing organization to implement the securities settlement system, equipped with globally competitive capability.

There were also discussions along these lines at the Financial System Council of the then-Ministry of Finance. In its report submitted in June 2000 entitled “The New Financial Framework for the 21st Century,” the Council indicated that “[i]t is preferable that a securities-settlement organization which handles various types of securities should emerge.” In addition, the Council proposed in the same report that it would be essential to establish a securities-clearing organization structured to “be constantly self-motivated to improve its own services in order to respond positively and flexibly to environmental changes,” and “for this to be realized, it would be critical to improve governance to appropriately reflect user opinions and to ensure contestability.” The Financial System Council also proposed that “the way JASDEC is managed should be reviewed from a broad perspective, including governance functions and organizational structure.”

In accordance with this proposal, the Committee for Reform of the Securities Clearing and Settlement System within the JSDA established a working group “to review the

structure and management of JASDEC,” which discussed JASDEC’s governance and other operational functions, and the pros and cons of its corporatization (reorganization to joint stock company or demutualization). As a result of these discussions, a report was submitted in September 2000, which recognized the need for JASDEC’s corporatization from the viewpoint of expandability and increased operational efficiency.

Upon its corporatization, it was decided that JASDEC should be structured in a manner that ensures that its governance function reflects user opinions. In the process of corporatizing JASDEC, the aforementioned Advisory Board on Securities Delivery and Clearing Reform formed a special committee to review specific matters such as basic corporate philosophy and the amount of capital. In November 2001, the committee submitted a report entitled “Specific Framework for Corporatization of JASDEC.” Corporatizing JASDEC was judged to be a preferable approach to realize the need to change the CSD to enable JASDEC’s corporatization. Changes to the CSD were instituted in April 2002, officially making JASDEC a company with shares.

The process of corporatizing JASDEC was not the same as in the case of the TSE, where its legal person (or corporate) status remained when the legal entity, as a legal person with members, was restructured as a company with shares. This is because the Japanese judicial system governing the legally incorporated foundations like JASDEC, which are public-interest corporations, differs significantly from the legal system governing business corporations, i.e., profit-making corporations. There is no system under existing legislation that allows public-interest corporations to restructure themselves to become another kind of legal entity such as profit-making corporations, while maintaining their legal person (corporate) status. Thus, as a means of converting a public-interest corporation to a business corporation, the authorities adopted the method of transferring the operation of the incorporated foundation to the business corporation after its dissolution, to enable the practical corporatization of the public corporation. In terms of specific procedures, a new company to which depository services were transferred was established in January 2002, and through subsequent capital injection, the framework of the business corporation was laid out. In June 2002, JASDEC became a business corporation after the authorities concerned approved the transfer of business.

In addition, the *Law Concerning the Transfer of Short-term Bonds* (CP), which governs the issuance of electronic CPs, came into force. Because the depository organization is required by law to be a business corporation, JASDEC had to become a business corporation in order to process electronic CPs.

On 10 January 2003, JASDEC was designated under the *Law Concerning Book-Entry Transfer of Corporate Bonds, etc.* (2001, No.75, termed *Law on Bond Book-Entry Transfer* below) as a depository agency, to handle various kinds of securities, and began to play a crucial role in the paperless issuance of bonds under the law. The corporate policies of JASDEC, as a business corporation, are (1) to focus on users and pursue highly transparent management, (2) to provide functions equivalent to those of an overseas CSD, and (3) to provide extremely safe and less expensive services. Given its public nature as a social infrastructure, many of JASDEC’s directors are representatives of participating securities firms and banks to ensure governance by participants. An

Operations Committee was formed to take opinions from business experts and make changes based on these opinions. Subcommittees were also formed for different projects, the proceedings of which are published on the JASDEC website.

3. Japan Securities Depository Center, Inc. and the Promotion of Reform of the Securities Settlement System

In recent years, many countries have vigorously implemented reforms in their securities settlement systems to enhance their competitiveness in capital markets. Japan is also engaged actively in the reform process, employing information technologies (IT) and launching DVP (a settlement system to avoid outstanding balances) and STP (electronic processing of trading through settlement).

a. Establishment of Short-Term Corporate Bond (Electronic Commercial Papers) Depository and Book-Entry Transfer System

On 10 January 2003, JASDEC was designated as a depository institution under the *Law Concerning Book-Entry Transfer of Corporate Bonds, etc.* and commenced operation on 31 of March 2003.

Traditionally, CPs were in the form of paper notes and had to be delivered to the assignee for settlement in Japan since 1987. Under the new JASDEC system, CP processing became paperless, completing the process of CP issuance, redemption, and transfer through the electronic paper book-entry system. Through this system, the settlement cycles can be shortened; potential risks pertaining to the delivery of printed securities are eliminated; and custodial costs are also abolished.

JASDEC's short-term corporate bond depository and book-entry transfer system adopt the DVP settlement system, which handles individual securities and related capital in a set (also called gross-gross type, BIS 1 model). The DVP settlement system, which settles individual accounts on a real-time basis, ensures the security of transactions and materializes the settlement of accounts, which satisfies issuer's need for quick financing.

The limited type of the face value of CP notes was also harming distribution. As stamp duty is imposed by individual paper note, the issuers tried to reduce the printing cost by issuing CP in a larger face value. Electronic commercial papers avoid such constraints, enabling the issuance and transfer of CP in smaller values. As a result, electronic CPs create flexibility in capital management and financing.

b. Implementation of the General Delivery-Versus-Payment Settlement System

The DVP settlement system is essential to avoid principal risk due to non-payment of price or non-receipt of securities notes. In addition, coordinated operation between the DVP settlement system and the STP system is required for efficient DVP settlement. In particular, there was a significant need for such settlement with institutional accounts.

The general DVP settlement system for stocks commenced in May 2004 to launch the DVP settlement scheme for the settlement of shares for securities firms, trust banks targeted at institutional investors and standing proxy (custodian) banks.

The securities gross type (capital net type) DVP settlement system was introduced to this settlement system, linking the settlement order information for the settlement of securities such as stocks, via the PSMS, which enabled efficient DVP settlement. This DVP settlement system settles securities transactions by each settlement order, i.e., by the gross of individual transactions.

The JASDEC DVP Clearing Corporation (JDCC), a wholly owned subsidiary of JASDEC, undertakes clearing services as a CCP by taking collaterals from the DVP clearing parties and managing risks.²⁰ While the capital is settled in net amount at the end of the day, as JDCC manages risk, DVP settlement with no principal risk is realized. DVP settlement parties are required to pledge a membership fund (cash) to DVP settlement. In terms of settlement of stocks, the Stock Exchange DVP Settlement System has been operating for exchange trading; stock exchange trading-DVP settlement was launched in the TSE and the Osaka Securities Exchange (OSE) in May 2001.

The JSCC has also implemented DVP as CCP since January 2003.

4. Expansion of Pre-Settlement Matching System

The PSMS enables institutional investors, securities firms and trust banks to handle post transaction checking via electronic processing, eliminating the person-hours required to send faxes or make calls. JASDEC implemented the PSMS for domestic trades by domestic institutional investors in September 2001. In February 2002, PSMS was expanded to cover trades by non-resident investors, public offering, placement, and trading of corporate bonds with share warrants (convertible bonds and corporate bonds with share warrants before the revision of the *Trade Act* on 1 April 2002). In addition, in May 2003, PSMS was expanded to cover JGBs, futures/options and transmission of information on net asset value per share, and information on price setting/termination from securities investment trust management companies to trust banks. When the general DVP clearing system was launched in May 2004, the operational linkage with PSMS was materialized.

To further improve the level of services, PSMS commenced operation to handle JGB repo trading and commenced providing pre-settlement matching services for the newly established JGBCC.

Since January 2006, PSMS has been connected to the depository and settlement system for short-term corporate bonds (CP), as well as for general bonds.

5. Implementation of Depository and Settlement System for General Bonds (Corporate Bonds, Fiscal Investment and Loan Program [FILP] - Agency Bond and Local Bonds)

Historically, the settlement of corporate bonds, investment-and-loan bonds, and local bonds was processed through the renewal of registration in about 160 registration agencies throughout the country. While the Japan Bond Settlement Network, commonly called JB-Net, functioned to connect the registration agencies and market players, as well as the system to electronically process DVP settlements existed via a linkage with BOJ Net, there were still many physical invoice transactions issued in

²⁰ A Central CounterParty (CCP) is a clearing organization to accept debts and credits for those concerned and settle the account

writing. Thus, the overall depository and settlement system for general bonds was still inefficient, and it remained difficult to increase its quality. It was considered that a hierarchically structured depository and settlement system was required to enable efficient settlement. Efforts have therefore been made to enact related laws to enable reform of the securities settlement system in Japan.

In January 2003, the *Law Concerning Book-Entry Transfer of Corporate Bonds, etc.* came into effect to allow paperless settlement of general bonds. In January 2006, JASDEC inaugurated its book-entry transfer system for corporate bonds, becoming the only settlement agency which processes book-entry transfers in Japan. As this system presupposes the application of STP in DVP settlement, it led to a significant advancement in the application of STP/DVP in securities settlement in Japan. The transition period for existing bonds issued as cash bonds and registered bonds ended in January 2008. The efficiency of corporate bond settlement should significantly improve when the transition is completed, and the liquidity of the Japanese corporate bond market is also expected to increase significantly.

6. Paperless Processing of Stock Certificates (Computerized Processing of Stock Certificates)

Paperless processing of stock certificates is the final goal of the computerized processing of securities instruments. This is the last procedure to be initiated in the gradual transition to computerization because intensive study of its effects was required. This is because stock trading emphasizes investor rights (right to self-interest and right to common interest) such as dividends and voting rights, and these rights of stock owners are registered on a stockholder list. In addition, a majority of stockholders keep their stock certificates on hand.

JASDEC has been providing depository services as a depository center for stock certificates since 1991. At present, about 75% of issued shares of listed companies are deposited with JASDEC. In terms of the settlement of shares listed at stock exchanges between securities firms, JASDEC facilitates deposit of securities without any physical delivery of securities. In a similar manner, transactions by institutional investors and nonresidents are processed by securities firms (brokers and dealers) and custodian banks in most cases through JASDEC's depository and clearing system without any physical delivery of securities.

In this sense, while computerization of securities trading had in fact been broadly implemented, there was a limit to the extent that administrative costs required for depositing and transferring share certificates or the cost on issuers was reduced, since there were a relatively large number of actual stock certificates.

The Legislative Council of the Ministry of Justice proposed in 2003 to introduce a system which promoted computerization, and in the following year the Financial Services Agency and the Ministry of Justice submitted a proposal for the revision of the *Law Concerning Book-Entry, Transfer of Corporate Bonds, etc.* and the *Commercial Law* to the Diet, which passed the revisions.

Before listed companies and market players actually adopt this system, administrative procedures, market practices, and computer system design need to be considered. Furthermore, it is essential to familiarize investors (stock holders) with the new

paperless system and raise the ratio of pre-depository of paper-based stock certificates with JASDEC to ensure a smooth transition. The computerization of stock certificate processing was implemented in 2009.

7. Conclusion

The reform of the securities clearing and settlement system in Japan has made significant progress through the establishment of settlement agencies and the realization of cross-sectoral computerization of securities processing, which have advanced institutional reforms. As a result of efforts made by the business sector, including JASDEC, the implementation phase may be in the final stage.

While at present there is some cost in terms of system investment in developing the securities settlement system, it is desirable that not only market players but also investors and issuers enjoy the benefits of computerization through the improvement of user convenience and cost reductions via the realization of STP, DVP, and paperless processing. In order to achieve this goal, both JASDEC and market players should set up a specific goal to improve the efficiency of the securities settlement system and to raise Japan's global competitiveness.

JASDEC's basic corporate philosophy (established in June 2006) is that it "recognizes its public role as the only securities depository center in Japan, and the continuous changes in both the domestic and the international environment and investment structures surrounding the capital market, while, from the viewpoint of both investors and users, JASDEC contributes to the development of society and the functions of the securities market, as a leader of the reform in the securities clearing and settlement system aimed at building highly credible, convenient and efficient securities clearing infrastructure." It is essential for market participants (i.e., JASDEC sponsors) to share this concept and cooperate with each other to improve the level of capital market infrastructures in Japan, as well as in the Asian region, under a national strategy.

VI. Current Japanese Market Situation

A. Tide for the Change

Fortunately, in the past several years the impediments isolating the domestic market from foreign markets have been removed in Japan through the efforts of policymakers and market participants. In 2008, the Financial Services Agency (FSA) revised the Financial Instruments and Exchange Act (FIEA) as part of its plan to enhance the competitiveness of Japan's financial and capital markets, establishing the legal framework for markets oriented towards professional investors (a private offering system for designated investors and designated financial instrument exchange markets). This provided the legal framework for the establishment of a new securities market as mentioned above, one not predicated on legal disclosure, corresponding to the U.S. Rule 144A market.

In addition, the taxation system was reformed in fiscal 2010 to reduce the tax on revenues from domestic corporate bonds held by nonresidents to zero. This is seen as the opportunity to put an end to the state of isolation of Japan's domestic markets. Having done away with these twin constraints in the legal and taxation systems that have conceptually separated domestic bonds from Eurobonds and other international bonds in Japan, if appropriate rules are provided for disclosure and registration (listing) in the near future, the necessity for separating domestic and international bonds will diminish, and Japanese market participants will witness a radical improvement in the mobility and convenience in the Japanese corporate bond market.

B. Current Conditions of the Japanese Corporate Bond Market

1. Going through various system reforms, the corporate bond market in Japan has developed as a free and efficient market and has played an important role in corporate financing. After the global financial crisis in 2008, despite showing downward trend in the second half of 2008, the corporate bond market has shown relatively steady recovery towards 2009 and 2010. The 11 March 2011 earthquake and tsunami hit the market, and the performance of the first half of 2011 showed the slowdown. As a result of the people's effort for the recovery of the Japanese economy, the corporate bonds market has been in the course of recovery.

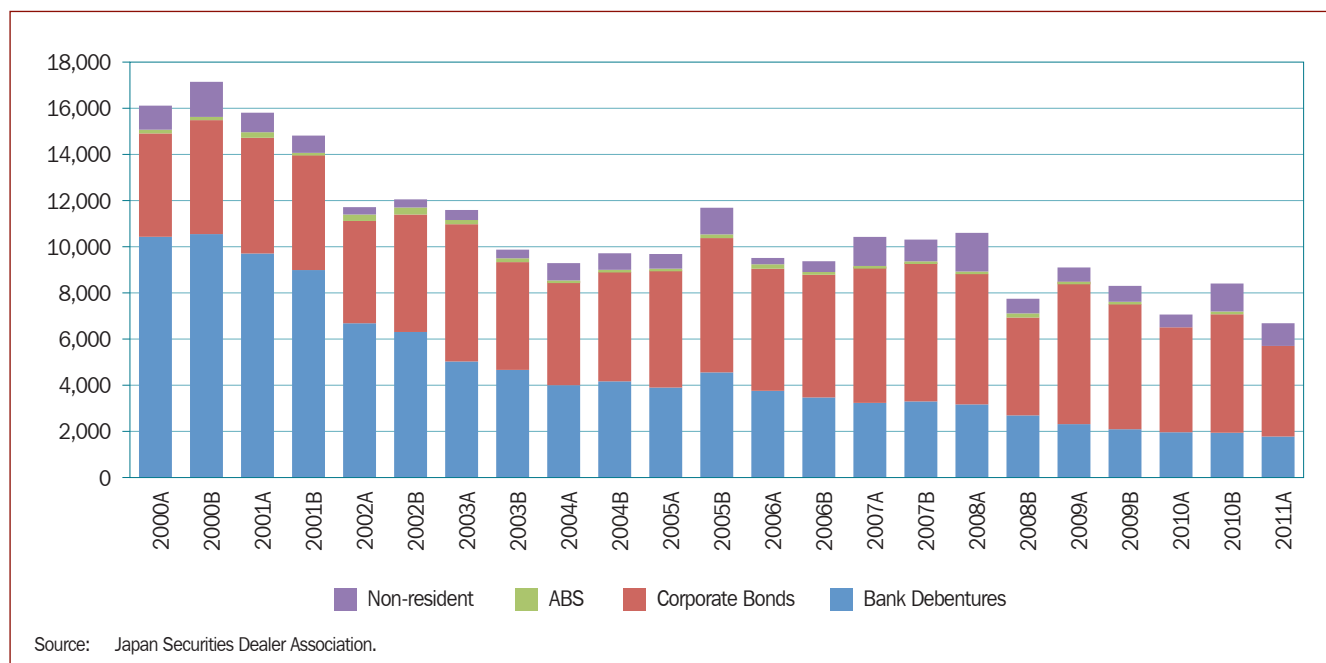
Figure 6.1 Semi-Annual Issuing Amount of Non-Public Sector Bonds, January 2000–June 2011 (¥ billion)**Table 6.1 Semi-Annual Issuing Amount of Non-Public Sector Bonds (¥ billion)**

	Bank Debentures	Corporate Bonds	Asset-Backed Securities	Non-Resident
2000A	10,432	4,479	161	1,042
2000B	10,548	4,938	140	1,520
2001A	9,708	5,014	241	845
2001B	8,990	4,980	97	749
2002A	6,685	4,433	279	319
2002B	6,307	5,088	306	352
2003A	5,029	5,947	182	434
2003B	4,664	4,670	166	375
2004A	4,000	4,517	23	750
2004B	4,168	4,742	89	717
2005A	3,899	5,074	77	635
2005B	4,556	5,820	160	1,154
2006A	3,758	5,290	193	273
2006B	3,470	5,314	120	468
2007A	3,235	5,910	22	1,259
2007B	3,299	6,019	50	942
2008A	3,169	5,655	103	1,674
2008B	2,693	4,240	180	634
2009A	2,314	6,174	1	613
2009B	2,093	5,423	100	689
2010A	1,962	4,548	0	553
2010B	1,941	5,134	120	1,212
2011A	1,777	3,925	0	983

Source: Japan Securities Dealers Association.

2. However, generally speaking, comparing the Japanese corporate bond market with those in the U.S. and Europe (i.e., Euromarket), corporate bond issuance is not as robust as that of the U.S. market. Japan's ratio is low compared with in the United States. Additionally, the importance of corporate bonds as a fund management tool is significantly lower in Japan compared with the U.S. and Europe. Clearly, the Japanese corporate bond market remains a small market compared with the U.S. and European markets.
3. Although various types of companies actively issue corporate bonds in the U.S. and Europe (Euromarket), the issuance of corporate bonds in Japan is still limited to fairly high-rated companies in specific sectors.

As far as Corporate bond holdings in Japan are concerned, the main holders are banks (depository institutions) with individual investors, investment trusts, and foreign investors being relatively minor players.

4. Furthermore, as many investors hold corporate bonds until redemption in Japan, the liquidity of corporate bonds is low and the secondary market is small.
5. As indicated below, there are many complex factors behind the small size of the corporate bond market in Japan. Although there are some factors that cannot be overcome easily, it is believed that there are many other factors that can be prevailed over with the steady efforts of market participants and relevant government agencies. Market participants need to correctly recognize and make efforts to overcome these factors.
6. It is believed that vitalization of the corporate bond market will promote the diversification and decentralization of financing methods by private companies, as well as the expansion of asset management opportunities for investors, leading to strengthening of the financial and capital markets. This in turn will result in the active and steady development of the Japanese economy. To this end, market participants need to take measures to vitalize the corporate bond market in their daily business and establish a solid and liquid market.
7. Since the 2008 global financial crisis, vitalization of the corporate bond market has become a particularly important and urgent issue. At the onset of the financial crisis, the short-term money market became extremely tight and many companies shifted to bank loans. In some cases, it was difficult to borrow money from banks, and new and rollover issuance conditions were very unfavorable in the corporate bond market. In light of these circumstances, private corporations clearly recognized the need to diversify their financing methods and the sources of funds.

Similarly, it has become increasingly essential to develop a corporate bond market with high transparency and liquidity that enables steady financing of large amounts of money on a long-term basis. Because strengthening the equity capital of banks and other financial institutions has become a major issue of global financial regulatory reform following the financial crisis, it is believed that banks' loan activities will change accordingly. It is expected that improving the

corporate bond market function within a new regulatory environment will result in the proper development of financing mechanisms, including bank loans, and contribute to the advancement, enhancement, and stability of Japan's financial and capital markets. The development of the TOKYO PRO-BOND market is in line with this movement.

8. Furthermore, developing the infrastructure of the corporate bond market in Japan and creating a more efficient corporate bond market with higher transparency and liquidity will increase the participation of foreign issuing corporations and investors including those from the Asian region. It will also help Japanese financial and capital markets play a role suitable for the economic scale of Japan in the global market.

Building a market that is useful for such professional investors as institutional investors will contribute to improving the diversity of corporate bond issuers, market usability, and diversification of asset management methods for investors, as well as enable Japanese market players to utilize human resources and information-analysis skills held by Japanese financial institutions and market participants for corporate bond issuance and financing by Asian and other foreign companies. It will also assist the Japanese capital market in playing an important role as a main market internationally and in the Asian region.

C. Factors Characterizing Corporate Bond Market and Its Problems

1. The Japanese corporate bond market has developed its flexibility and efficiency through system reforms such as the abolishment of regulations on corporate bond issuance limits and the revision of the trustee company system (1993), the abolishment of grade criteria for corporate bond issuance and deregulation of bond covenants (1996), and the electronic registration of corporate bond certificates (2006). The credibility of corporate financial reporting has been boosted by developing accounting standards and enhancing the audit system. The above actions have also increased the attractiveness of corporate bonds as financial instruments among investors. Because many companies have recently issued corporate bonds targeting individual investors, corporate bonds are also becoming an attractive investment instrument for individual investors.
2. On the other hand, in spite of the system reforms mentioned above, the corporate bond market in Japan is still small. As has been pointed out, this situation lies in the complex interaction of various factors such as those indicated below:
 - a. Looking at the flow of funds in Japan, while the public sector is significantly short of funds, private non-financial corporations tend to have a surplus of funds. Particularly, in a situation where economic growth is slow and capital investment is restrained, the demand for long-term funds has been sluggish and many companies have issued corporate bonds not to raise new long-term funds but to roll over their existing long-term borrowings.
 - b. In an environment marked by low small- and medium-sized corporate finance demand, because of the government's active supportive measures

and financial policies to help private small- and medium-sized corporations and intensifying loan competition among financial institutions, including banks, large corporations and small- and medium-sized private corporations have been able to finance themselves at lower cost with bank loans rather than corporate bond issuance for a long period of time.

- c. The “Chicken-or-the-Egg” problem, i.e., the inactive issuance of corporate bonds results in and is caused by the low liquidity of corporate bonds, has yet to be solved. Consequently, the liquidity of corporate bonds remains low. As a result, conditions in the secondary market have not been properly reflected in the primary market in a timely manner. Additionally, although market participants need to improve the transparency of corporate bond prices in the secondary market, the “Reference Statistical Prices [Yields] for OTC Bond Transactions” published by JSDA is not sufficiently reliable to serve the role of properly reflecting secondary market conditions. Furthermore, there may be room for further development and improvement of a settlement and clearing system and a corporate bond repo market that can contribute to stimulating the secondary market.
- d. Due to corporate bond underwriting practices, flexible issuance in accordance with needs is difficult because the issuable period of corporate bond is limited and the issue timing is concentrated. Corporate bond issuance procedures are not flexible and agile because the roles and responsibility sharing among securities companies conducting underwriting examinations (Type I Financial Instruments Business Operators), issuer, audit corporations, and certified public accountants have not been defined and the handling rules for comfort letter have not been clarified. Furthermore, the pot system, which is popular in the U.S. and Europe as a standard method of determining the conditions of issuance, has not been established in Japan; as a result, the conditions of issuance cannot be quickly set.
- e. Due to the small size of the corporate bond market in Japan, some Japanese institutional investors have not established an adequate research system nor trained sufficient analysts to conduct credit analysis of corporations, which has been a mid- to long-term issue in the market. Moreover, when investing in a corporate bond, investors in some cases significantly rely on external rating agencies, and tend to adopt a similar investment strategy with those adopted by other institutional investors. Individual investors have difficulty obtaining information on corporate bonds.
- f. There was no sufficient tax exemption system for investment in corporate bonds by non-resident investors until June 2010, when such a system was introduced to promote investment in and holding of corporate bonds by foreign investors. Consequently, up to now, the corporate bond market is not a good place to actively invest for investors with a higher risk appetite.
- g. Defaults by issuing companies have been very rare in Japan. Therefore, sufficient data on the relationship between the credit risk of the issuers and issuance conditions have not been accumulated yet.

- h. In many cases, a negative pledge giving all corporate bonds the same priority is attached to a corporate bond.²¹ As a result, when the issuer is in default, there is a concern that the rights of corporate bondholders will be subordinate to the rights of other creditors. As the covenants that are also attached to debts other than the corporate bonds are not fully disclosed, the preferred or deferred relationship between corporate bonds and other debts is unclear. This point should be improved from the perspective of investor protection.
 - i. In an investment environment where there have been very few corporate bond defaults, a commissioned bank or commissioned person (corporate bond administrators) has not been appointed in many cases except for corporate bonds targeting individual investors. Therefore, there is no consensus about the role of a commissioned bank or commissioned person (corporate bond administrator) and the preservation attachment for corporate bond holders when the corporate bond is in default. There is also no discussion has been held regarding cost sharing.
 - j. As laws and regulations, the concept of bankruptcy, and the role of financial institution in the corporate reconstruction process in Japan are different from those in the U.S. and Europe, many people in Japan believe that only companies that have a certain level of credit strength can issue corporate bonds.
 - k. There remain taxation complexities in the market, such as different tax treatments depending on the type of assigner of a corporate bond. This is one of the factors that impede higher liquidity for corporate bonds.
3. One of the reasons why the corporate financing structure in Japan relies heavily on bank loans rather than corporate bond issuance is that the risk premium of bank loans is lower than that of corporate bonds due to the reasons listed from (a) to (c) below. This is particularly significant in Japan. Therefore, the funding cost of borrowing is cheaper than that of corporate bond issuance. If an appropriate spread could be set that reflects the credit risk, market liquidity, and the handling of pledges regardless of bank loans or corporate bonds, corporate bonds would become more attractive for issuers of corporate bonds as well as for investors, contributing to the diversification of financing methods for corporations and the variety of investment instruments for investors. While it is pointed out that setting an appropriate risk premium on bank loans is an important issue for the financial system in Japan, it is necessary to reduce the risk-premium gap between bank loans and corporate bonds by improving the efficiency, transparency, and liquidity of the corporate bond market. This issue needs to be solved by both market participants and banks by tackling their own issues one by one based on their individual viewpoints, as well as through cooperation with each other in establishing more transparent and sound market practices.

²¹ Negative Pledge Clause - A covenant provision in a bond agreement whereby the issuer agrees not to pledge any assets if such pledging would result in less security for the agreement's bondholders.

- a. In circumstances where companies have less demand for funds because of the sluggish economy, banks have made transactions with borrowers from a mid- and long-term viewpoint and/or under a comprehensive service scheme, including settlements and foreign exchange. Due to public supportive measures and financial policy and intensifying lending competition among banks, lenders cannot set loan interest rates that are appropriate for the real credit risk of the borrower. The related party has to carefully analyze and determine how to evaluate the compensation gained by banks that provide comprehensive financial services and the long-term credit risk involved, and how to compare the cost of corporate bond issuance based on liquidity.
 - b. Banks lend money based on detailed information such as the pledge provided by a borrower company and the short-term funding requirements of the borrower, while the issuance of and the investment in corporate bonds are based on disclosed information such as timely disclosure by securities exchanges, prospectuses, and securities reports. In this manner, banks obtain a broader and more detailed range of information that seems to affect their loan conditions. The related party needs to consider how the market evaluates and determines the above facts.
 - c. Financial institutions such as banks have taken provisional measures through the management of pledges provided by borrowers before executing loans. Also, when the borrower falls into management difficulties, banks not only preserve and recover the debts, but, in some cases, also play a certain role in the insolvency, reorganization, or reconstruction process of the borrower.
4. Corporate bonds are more specific in nature than shares, and their issuing conditions vary in each case. A syndicate loan is also an agile funding method with high liquidity that is similar to a corporate bond. To vitalize the corporate bond market, it is necessary to be developed infrastructure taking into consideration the similarity of corporate bonds to syndicate loans.
 5. Credit default swap (CDS) transactions have recently increased in the U.S. and European markets, with some large-sized companies in Japan also actively conducting CDS transactions. We need to promote the sound development of CDS transactions and the CDS market in Japan, as it supplements the liquidity of the corporate bond market. We also need to carefully monitor the relationship between the CDS market and the corporate bond market.
 6. As a result of the fiscal crisis, some developed countries have recently run up huge financial deficits, focusing attention on the purchase levels and the secondary market prices of government bonds in capital markets. Therefore, we need to keep a close eye on how trends in the government bond market affect the corporate bond market.

D. Reducing the Blackout Period and Expansion of Funding Sources

1. The professional securities market as shown above will increase the convenience for Japanese and Asian issuers and holders of corporate bonds by reducing the blackout period in Japan, simplifying or omitting issuance procedures, omitting procedures in the secondary market, and reducing procurement-related costs, including disclosure costs. This can be done through the establishment of public issue market for professional investors that eschews the legal disclosure requirements applied to retail investors.
2. The expansion and diversification of funding sources (greater distribution of debt portfolios) can be carried out by:
 - a. The creation of a professional issuing market employing English-language disclosure,²² increasing convenience for overseas issuers.
 - b. Limiting market participants to institutional investors and other professionals to ease the obligation of disclosure for issuing companies, and thus expand opportunities for funding for Japanese and regional issuers.

E. Inconvenience of the Current Disclosure System for Public Offering

1. Many of the Japanese corporate bond issuers are having critical views that:
 - a. The Japanese public offering market for domestic corporate bond has been subjected to strict disclosure requirements, which have originally been designed for the Japanese retail investors.
 - b. In reality most of the bonds issued have been purchased by the professional investors.
 - c. On the other hand, existing private placement markets in Japan are not easy to use for issuers and investors. They do not have a secondary market.
 - d. As a result, due to strict restrictions, the chance and the period that issuers can make quick and timely issuance of corporate bonds in the Japanese domestic market are extremely limited through the year in comparison to the Eurobond market.
2. Domestic securities-related regulations for retail investors, such as legal disclosure regulations, will not apply in the new TOKYO PRO-BOND Market.
3. By excluding ordinary and amateur investors, such as private individuals, and catering exclusively to professional investors (institutional investors, etc.), this new market will be able to waive the legal obligation of disclosure applied to retail investors.

²² Japan is in the course of introducing a partial English based documentation for disclosure from April 2012; Although the information for securities should be submitted in Japanese, a most part of the disclosure information for issuer (including already disclosed reference information) can be submitted in English, except for a certain information. (Non-resident issuers' burden will be reduced).

F. Due Diligence by Securities Companies

1. Public Offering

All public offering in the Japanese domestic bond market is subject to due diligence, which are conducted in line with JSDA regulations “Rules for Underwriting Due Diligence of Securities” and “Detailed Manual on Rules for Underwriting Due Diligence of Securities” (hereafter “JSDA Due Diligence Rules”), by each underwriting syndicate member’s Due Diligence Department or Due Diligence Board who is obliged to manage due diligence independently from underwriting business promotion units such as corporate finance group, debt capital markets, investment banking group and the like. Unless JSDA Due Diligence Rules is fulfilled and approved by the Due Diligence Department or the Due Diligence Board, the securities company is not allowed to underwrite the bonds.

Also JSDA Due Diligence Rules require lead manager(s) to obtain a comfort letter. Exempt issuers such as sovereign and quasi-sovereign issuers may be outside the scope of the comfort letter.

JSDA Due Diligence Rules specifies what items to be checked from view point of FIEA and other relevant rules and regulations. Therefore, JSDA Due Diligence Rules are regarded as a formality examination rather than business due diligence.

2. Private Placement

JSDA Due Diligence Rules will not officially apply to small number-private placement (SN-PP), qualified institutional investor (QII)-PP, Offer to Specified Investors (SI). Having said that, due diligence will be conducted depending on an underwriter’s judgment on its necessity. Most cases will be business due diligence instead of formality examination based on JSDA Due Diligence Rule items. In the private placement scheme, an underwriter may acquire a comfort letter as long as relevant parties agree, although JSDA Due Diligence Rules do not require lead managers to acquire a comfort letter.

G. Determination Process for Corporate Bond Issuance Conditions

The establishment of a rational determination process for corporate bond issuance conditions is necessary.

- a. While securities companies conduct a bond demand estimate survey in the process of determining conditions of issuance, the resultant conditions do not necessarily reflect market conditions due to duplicated or false demands. It is pointed out that this is one of the factors that triggers “sale at a discount” (sale under conditions inferior to the conditions of issuance) of corporate bonds in the secondary market.
- b. For instance, in the U.S. the so-called “pot system” is commonly used for the determination of corporate bond issuance conditions. The system eliminates the duplicated or false-investor demand and increases the transparency of the conditions determination process. It also standardizes the corporate bond

issuance procedure and shortens the period required for issuance, resulting in smoother issuance of corporate bonds.

- c. Market players have seen some corporate bond issuances that used the pot system in Japan. Market players believe that it is necessary for market participants to establish a guideline to share common views on practical issues, such as thorough control of client data by securities companies, and find a solution as soon as possible for the purpose of establishing a rational determination process for corporate bond issuance conditions. Introducing the pot system in Japan may be one option. In any case, careful examination is required.

H. Measures to Cope with Default Risk

For the vitalization of the corporate bond market, it is necessary to develop and construct a lower-rated corporate bond market that enables not only high-rated issuers but also corporations with relatively higher credit risk to use the corporate bond market. JSDA and market participants plan to develop the following measures that will protect investors when business conditions deteriorate in issuing companies or companies default on their corporate bonds, for the purpose of expanding the investment in corporate bonds issued by companies with relatively higher credit risk.

1. Granting of Covenants and Information Disclosure

a. Granting of Covenants

- i. Since the abolishment of grade criteria and the deregulation of the financial special contract in 1996, issuers can flexibly grant covenants on corporate bonds issued in and after 1996 reflecting the financial condition of the issuer. JSDA believes that such a flexible scheme should be maintained and enhanced in the future for vitalization of the corporate bond market.
- ii. Currently, covenants granted on a corporate bond issue mainly cover the negative pledge clause (a clause prohibiting the issuer from creating any security interest over a certain property specified in the provision) and cross acceleration.
- iii. While the negative pledge clause is a special agreement to protect investors that prohibits the issuer from creating a security interest over other non-secured debts, it is usually effective only among corporate bonds. In 2009, only two corporate bonds targeting individual investors had covenants covering other debts and loans.

On the other hand, in loans, a certain preservation measure is generally taken in response to the condition of the debtor at the time of executing the loan. In this regard, a corporate bond that was issued before the loan is likely to defer to other debts and loans from a property preservation viewpoint. Therefore, it has been pointed out that theoretically the granted covenants may affect the recovery of debt in the case of corporate bond default by a company with relatively higher risk.

- iv. In the future, when JSDA and market participants promote expanding issuance of and investment in corporate bonds issued by corporations with relatively higher credit risk, it will be necessary to develop an environment where various kinds of covenants can be granted flexibly to reflect the capital and financial

policies of the issuer and to meet the needs of investors, with such covenants being fully reflected in the issuance conditions for corporate bonds. Having said that difficulty can exist when the bond issuer disapproves the covenants to avoid the issue.

- v. For this purpose, taking into consideration the examples in the U.S., JSDA and market participants need to prepare and illustrate by example a model of standard covenants for corporate bonds issued by corporations with relatively higher credit risk as reference to issuers, investors, and securities companies. It will also be necessary to disseminate market practices that enable fundraisers to grant flexible covenants and determine reasonable issuance conditions. But, in Japan, as a general practice, the secured bank loans system has been established; it may be difficult to introduce the US system directly.
- vi. Among these issues, JSDA and market participants should address the use of secured corporate bonds issued by corporations with relatively higher credit risk and the relationship of these corporate bonds to the order of priority of loan pledges.

b. Disclosure of Information on Covenants

- i. The type of covenants granted affects the holder of a corporate bond when the corporate bond is in default and the holder tries to recover the debt. Therefore, it is important for holders to check the covenants granted on other corporate bonds and loans. Holders cannot be confident in making an investment in a corporate bond without proper disclosure of covenants granted on other debts.
- ii. In Japan, covenants granted on a corporate bond are disclosed in a prospectus as a disclosure item at the time of issuance. In the standard form, covenants of debts including loans are to be disclosed in the annual securities report. But it may be difficult to say whether that is a standard practice in Japan.
- iii. As of the end of the fiscal year in March 2009, 219 companies disclosed the covenants of loans and other debts in their annual securities reports. Many covenants relate to financial indicators such as maintenance of net assets and maintenance of profits. There were a few companies that disclosed covenants relating to default such as cross acceleration.
- iv. In the U.S., covenant information on corporate bonds and loans is disclosed as follows:
 - (1) The annual report Form 10-K discloses basic information such as the type of covenants, whether or not the covenants are granted, and the compliance status. JSDA do not know the details, as no indication is made as to which covenants are granted on which debts.
 - (2) If the corporate bond or the loan is subject to important events that require submission of the current report Form 8-K, the detailed information is disclosed on that form. The Form 8-K is a very broad form used to notify investors of any material event that is important to shareholders or the United States Securities and Exchange Commission. This is one of the most common types of forms filed with the SEC. After a significant event like bankruptcy or departure of a CEO [Chief Executive Officer], a public company generally must file a Current Report on Form 8-K within four business days to provide an update to previously filed quarterly reports on Form 10-Q and/or Annual Reports on Form 10-K. Form 8-K is required to be filed by public companies with the SEC pursuant to

the Securities Exchange Act of 1934, as amended. A Form 10-K is an annual report required by the U.S. Securities and Exchange Commission (SEC), that gives a comprehensive summary of a public company's performance. Although similarly named, the annual report on Form 10-K is distinct from the often glossy "annual report to shareholders," which a company must send to its shareholders when it holds an annual meeting to elect directors (though some companies combine the annual report and the 10-K into one document). The 10-K includes information such as company history, organizational structure, executive compensation, equity, subsidiaries, and audited financial statements, among other information.

- v. For the purpose of developing an environment where investors can be confident in making an investment in corporate bonds, JSDA and market participants need to discuss the following issues based on the disclosure system in the U.S., and take measures to properly disclose the necessary information on covenants from an investor protection viewpoint.
 - (1) Disclosure in an annual securities report (promotion of disclosure of covenants about default);
 - (2) Statutory disclosure equivalent to the current report Form 8-K in the U.S.;
 - (3) Timely disclosure required by securities exchanges.

2. Commissioned Company for Bondholders

a. Credit Risk of Corporation and Commissioned Company for Bondholders

- i. A commissioned company for bondholders is in principle appointed at the time of issuance of the corporate bonds under the *Companies Act* and acts as a statutory agent of corporate bondholders to monitor the financial condition of the issuer and preserve/recover the debts at the time of default.
- ii. Currently, while the commissioned company for bondholders is appointed for corporate bonds targeting individual investors, most corporate bonds targeting institutional investors do not appoint a commissioned company for bondholders.
- iii. It is necessary to maintain the current system that enables a corporation with relatively lower credit risk and having a high profile in the corporate bond market to issue corporate bonds flexibly at lower cost. On the other hand, for the purpose of promoting issuance of and investment in corporate bonds of a corporation with relatively higher credit risk, it is possible to grant various covenants as mentioned above on such corporate bonds. Market participants also need to develop an environment where the commissioned company for bondholders can sufficiently fulfill the role of monitoring financial condition and preserving/recovering debts, and where such covenants can be properly reflected in the issuance conditions.
- iv. Market participants also need to prepare a system whereby the absence of a commissioned company for bondholders would not damage the credibility of the corporate bonds issued by such companies and the corporate bond market as a whole if the credit risk increases due to deterioration in the business conditions of the issuer.
- v. Market participants can choose two approaches regarding the appointment of a commissioned company for bondholders: (a) appoint a commissioned

company for bondholders for all corporate bonds; or (b) appoint a commissioned company for bondholders of corporate bonds issued by a corporation with a relatively higher credit risk. For the time being, while discussing the tasks of the commissioned company for bondholders, it is useful for market participants to establish approach (b) as a market practice.

- vi. In the case of corporate bonds issued by a corporation with relatively higher credit risk, market participants will need to prepare and illustrate by example a standard model of appointing a commissioned company for bondholders that can be used as a reference for issuers, investors, and securities companies, and establish the appointment of a commissioned company for bondholders as a market practice.
- vii. Currently, many main banks play the role of a commissioned company for bondholders. Some market participants are concerned that a conflict of interest could occur before or after a corporate bond default if, in the future, corporate bond issuers become more diversified and more corporations with relatively higher credit risk issue corporate bonds. Therefore, market participants need to take measures to increase the credibility and transparency of tasks assumed by the commissioned company for bondholders, as well as discuss what tasks they are to assume.

b. Commissioned Company for Bondholders in the Future

- i. One of the reasons why many issuers do not appoint a commissioned company for bondholders is that issuers are doubtful about whether the tasks assumed by the commissioned company for bondholders justify the cost incurred by the issuer. On the other hand, commissioned companies for bondholders point out that their responsibilities as commissioned company for bondholders are substantial under the *Companies Act*.
- ii. The relationship between the responsibilities and costs of the commissioned company for bondholders should be considered carefully based on the fact that the credit risk of the issuer closely relates to the responsibilities of the commissioned company for bondholders. Market participants need to define the tasks assumed by a commissioned company for bondholders and also establish a system whereby these various factors can be properly reflected in the costs through a market mechanism.
- iii. Tasks assumed by a commissioned company for bondholders in the U.S. (i.e., “Trustees”) are significantly different before and after a corporate bond default. Particularly, the tasks before default include only administrative processes, such as receiving a disclosure document including the annual report on a regular basis, and do not include the tasks of requesting financial information, monitoring, and review.
- iv. Based on the tasks of a trustee in the U.S., there is a need to consider that, for example, the tasks of a commissioned company for bondholders will be limited to the preservation and recovery of debts after the default of corporate bond, or that a set different requirements will be set for appointing a commissioned company for bondholders and for its tasks depending on the credit risk of the issuer or the type of investors.
- v. It is possible that the position and the rights of corporate bondholders will be affected by an event concerning the corporate bond issuer besides default, such as mergers and acquisitions (M&A). Therefore, market participants need to discuss

how to handle event risk as one of the issues relating to the tasks assumed by a commissioned company for bondholders.

I. Taxation (Withholding Tax on Interest Income)

1. Tax-Exemption System for Interest on Corporate Bonds held by Non-Residents

In June 2010, the *Tax-Exemption System for Interest on Corporate Bonds held by Non-Residents (A Three-Year Temporary Measure)* was enacted. This measure intends to promote the investment in and holding of corporate bonds by foreign investors. JSDA and market participants need to disseminate this system and properly apply it on a practical basis to ensure its wide use, as well as cooperate with the relevant organizations and agencies to establish this as a permanent system.

2. Handling of Interest on Corporate Bonds under Unified Taxation Treatment for Financial Income

To increase individual investors' investment in and holding of corporate bonds and public bond investment trusts, there is a need to create an environment where individual investors will be able to easily accept the investment risks. On the taxation side, it will be very useful to promote the unification of the financial income taxation system and allow individual investors to include their capital loss and default loss on corporate bonds and public bond investment trusts to the aggregation of their financial income for the purpose of taxation. In this case, it is necessary to discuss and solve the so-called problem of taxable and non-taxable treatment. JSDA and market participants need to continue promoting the unification of tax treatment of financial income in cooperation with the relevant organizations and agencies.

3. Related Tax Information

The Japan Ministry of Finance has approved a temporary reduction of the withholding tax applied to dividends paid to non-resident investors. The effective rate for foreign investors is 7% and 10% for local investors. This rate reduction lasted until 31 December 2011, after which the withholding tax rate applied to dividends will increase to 15% for foreign investors and 20% for local investors if a further extension of the reduction is not approved by the Diet.

J. Bond Investment Education and Bond Investor Relations

1. It has been pointed out that there are few opportunities to educate individual investors about corporate bonds and that no sufficient basic data are provided for the investment in and the analysis of corporate bonds, such as which corporate bonds are issued and traded, interest rates, and prices.
2. Some institutional investors have not established an adequate research system and nurtured enough analysts to conduct credit analysis of individual issues, which has become a mid- to long-term issue in the market. Moreover, when investing in a corporate bond, investors, in some cases, significantly rely on external rating agencies, and tend to adopt a similar investment strategy with those adopted by other institutional investors.

3. Investor relation (IR) for corporate bonds is important as an interactive communication tool between the issuer and investors, and therefore, some parties insist that the issuer should carry out IR activities proactively and continuously.
4. In addition to enhancing and organizing corporate bond investment education programs and basic data on the corporate bond market, it is necessary to exchange opinions with institutional investors and actively encourage corporate bond IR activities by issuers to promote further understanding on corporate bond investment.

K. Internationalization of the Bond Market and Collaboration with Asia

1. To implement the concrete measures mentioned above, there is a need to establish a market that can serve as a good example for the development of corporate bond markets in emerging countries from an international viewpoint. Additionally, there is a need to fully open the Japanese corporate bond market to the global participants and make it easy to use not only for both domestic and overseas issuers and investors.
2. The Asian Bond Markets Initiative (ABMI), an initiative agreed upon at the meeting of financial ministers in ASEAN Plus Three countries (Japan, China, and Republic of Korea), is a scheme to comprehensively consider and take measures to foster harmonization in the bond markets in Asia, promote the issuance of local currency-denominated bonds, expand demand, and improve the regulatory framework and relevant infrastructure.
3. JSDA and market participants will continue their cooperation with and support for the ABMI. They also need to take measures that can promote globalization of the Japanese corporate bond market by actively conducting promotional activities and exchanging opinions with foreign market participants to make the Japanese corporate bond market easy to use by foreign issuers and investors, including those in Asia.

L. Foreign Bonds, Foreign Exchange Control and Liberalization of the Yen

While the currency of denomination for bonds is the currency of a sovereign state, bonds are used not as a means of payment but as a means of high-risk, high-return investment of savings. Generally, bonds require disclosure of information on the creditworthiness of issuers. Unlike currencies, however, there is no institution to control the supply of bonds, particularly international bonds or foreign bonds, such as a central bank in the case of currencies. However, markets control the supply of bonds through interest rates. Money laundering regulations and the *Patriot Act* are not applicable to bonds.

Generally, bonds are created under contracts and, as such, terms and governing laws can be varied for bonds under the principle of freedom of contract and the practices of jurisdictions. Unlike currencies, which only sovereign states have the right to issue,

bonds represent credit that can be created by the private sector. However, because the value of bonds is expressed by denomination in existing currencies, and because they are paid in existing currencies (aside from the European Currency Union [ECU] basket account in the past, which was transformed into the Euro, but even in this case the currency basket backs up the currency account), issuance of bonds is fundamentally affected by policies that restrict foreign exchange transactions in the countries of the currencies concerned and policies for the liberalization of those currencies. For Asian countries, the liberalization of its currency is an important issue. The Japanese experience may be of some use as an illustrative case.

M. History of Japan's Foreign-Exchange Policy Change and the Liberalization of the Yen

The history of the relationships described above may be explained by Table 6.2 below.

Table 6.2 History of the Foreign-Exchange Policy Change and Liberalization of the Yen

Year	Event
1970	The Tokyo capital market was inaugurated; internationalization of the yen; Asian Development Bank bond.
1971	Nixon Shock: Dollar-gold convertibility suspended; shift of the yen to the floating-rate system in 1973.
1972	GTE stock public offering in Japan (first foreign stock).
1973	Australian government bond (first samurai bond issue).
1974	First German mark public offering of a corporate bond (Mitsubishi Heavy Industries).
1975	First Swiss franc public offering of a corporate bond (Mitsubishi Chemical).
1977	<ol style="list-style-type: none"> Expansion of foreign exchange reserves, yen interest rates drop due to a decline in private-sector fund demand: a record issuance of samurai bonds. Lifting of the ban on the issue of Euroyen bonds by nonresidents: first issue by the European Investment Bank (EIB).
1984	<p>Japan-U.S. Yen-Dollar Committee (Japan-U.S. financial market frictions prompting further internationalization of the yen).</p> <ol style="list-style-type: none"> Substantial easing of issuer qualifications for nonresident Euroyen bonds. Lifting of the ban on the issue of Euroyen bonds by residents; Euroyen bonds, first issue: Mitsubishi Heavy Industries' Euroyen CB worth ¥30 billion (180-day restriction on the recycling of Euroyen bonds to Japan – ban on bringing them in).
1985	Plaza Agreement (major industrialized nations' coordinated response to dollar interest rate rises due to the U.S. trade and fiscal deficits); the managed floating exchange rate system.
1990	Weakening of the yen following the collapse of the bubble economy in Japan.
1993	Abolishment of regulations on corporate bond issuance limits and revision of the trustee company system.
1994	Abolition of recycling restrictions on sovereign Euroyen bonds; first Alpine bond issued.
1996	Foreign exchange control abolished under the Tokyo Big Bang by the Hashimoto Cabinet; Abolition of recycling restrictions on Euroyen bonds issued by residents.
1996	Abolishment of grade criteria for corporate bond issuance and deregulation of bond covenants.
1997	The Asian currency crisis and failures of Sanyo Securities, Hokkaido Shokutaku Bank, Yamaichi Securities.
1999	Appreciation of the yen in the wake of the bursting of the U.S. information technology bubbles.
2006	Electronic registration of corporate bond certificates started.
2010	Announcement of the commencement of the TOKYO PRO-BOND Market.

Source: ADB Consultant.

N. Derivatives Market

1. Bond Futures Trading

Trading in securities futures (Government National Mortgage Association [GNMA] certificates) first started in 1974 in the U.S. Trading in 10-year government bond futures was conducted on the Tokyo Stock Exchange (TSE) in 1985—the year in which they were issued in massive amounts—which was the first financial futures trading in Japan.

In 1988, super long-term (20-year) government bond futures (discontinued in 2002) were listed on the TSE, and trading in U.S. Treasury bond futures—which had the largest trading volume in the world—started on the TSE in 1989. The trading of Treasury bond futures was suspended in Japan in 1998. With the trading in medium-term (5-year) government note futures starting on the TSE in 1996, Japan had finally developed a product mix comparable to that of other countries.

Bond futures are generally traded on the basis of a fictitious issue called a benchmark issue whose price is believed to indicate the level of yield curve then prevailing. Therefore, the price of bond futures is formed in the belief that the prices of individual bonds are above the yield curve of the benchmark issue, or above a yield curve that runs parallel to it. Because a seller can choose an issue just as in a regular settlement, the seller chooses the most reasonably priced issue at that point in time, but the price of the issue to be delivered is computed by multiplying the price of the benchmark issue by a conversion factor prescribed by the exchange.

One of the characteristics of bond futures trading in Japan is that issues are traded in units with a total par value of ¥100 million, about 10 times as large as that of other countries. This compares with \$100,000 in the case of treasury-bond futures traded on the Chicago Board of Trade, or 100,000 Eurodollars in the case of BUND futures traded on the EUREX. This is due to the fact that in cash bond transactions, bonds whose value falls short of ¥100 million are treated as a fraction of a trading unit. As bond-futures trading is usually compared with other countries in terms of the number of contracts, futures traded in Japan tend to be underestimated. Characteristic of the bond futures market of Japan is that it is concentrated in trading in long-term government bond futures. This reflects the fact that the maturities of government bonds are heavily concentrated in 10-year issues, as with cash-bond trading, which is not unique to the bond futures market.

Since the mid-1990s, however, the concentration of cash government bond trading on the benchmark issue, which was a phenomenon peculiar to Japan, has eased. Since the end of March 1999, the practice of designating a government bond as a benchmark issue has been discontinued, with 10-year government bond futures assuming the role played by benchmark issues. Among new products, the contract for difference futures (CFD) on mini-long-term government bonds, which are one-tenth the amount of normal bonds, were listed on the TSE from the end of March 2009, but no trading has occurred since June 2009.

2. Financial Futures Trading

Currency futures trading started in the U.S. in 1972, and Eurodollar short-term interest rate contracts were the first interbank futures listed on a U.S. exchange in 1982. In Japan, Euroyen futures, Eurodollar short-term interest rate futures (whose trading was suspended in 1998), and Japanese yen-U.S. dollar currency futures (contracts were delisted in 1992) were simultaneously listed on the Tokyo International Financial Futures Exchange (TIFFE) in 1989. These contracts were followed by the TIFFE/Tokyo Futures Exchange (TFX) listings of dollar-yen futures in 1991; 1-year Euroyen futures in 1992 (trading was suspended in 1998); Euroyen LIBOR futures in 1999; 5-year and 10-year yen Swapnotes in 2003 (trading was suspended in 2007); and Exchange FOREX margin contracts (Click 365) on U.S. dollars, Euros, UK pounds, and Australian dollars in 2005. In 2009, the TFX listed overnight (O/N) uncollateralized call rate and general collateral (GC) spot-next (S/N) repo rate interest futures.

Financial futures trading in the U.S. began with futures and futures options on commodity exchanges while European countries introduced financial futures exchanges for these products. In Japan, the market is split with bond and stock futures and futures options trading on the stock exchanges, while interbank interest rate and currency futures and options are traded on the TFX, a separate market established by some banks and securities companies.

On the TFX, trading was born concentrated from the start in yen short-term rate futures, and not many currency futures, options on yen interest rate futures (introduced in 1991), or 1-year yen interest rate futures have been traded. To increase the liquidity of these financial futures, the market-making system was introduced for dollar short-term rate futures and yen-dollar currency futures in 1990; dollar-yen currency futures in 1991; and options on yen short-term rate futures in 1992. However, their liquidity has not improved much.

Meanwhile, in April 1996 TIFFE introduced a TIFFE-Standard Portfolio Analysis of Risk (SPAN) system on the basis of which the amount of margin commensurate with the risks involved is computed. Moreover, in an effort to stimulate financial futures trading, it linked the prices of its products to those of the London International Financial Futures and Options Exchange and extended its trading hours in the same year. It made likewise efforts to stimulate trading by introducing the night-trading system for dollar-yen currency futures in 1997 and by extending the night-trading hours in 1998. Since 1995, however, TIFFE/TFX's business, which had grown during the first half of the 1990s, has been decreasing on account of the extremely low interest rate climate.

3. Bond Options Trading

Treasury bond (T-bond) options trading on the Chicago Board Options Exchange and T-note options trading on the American Stock Exchange, conducted simultaneously in 1982, constituted the first trading in listed bond options. T-bond futures options were traded on the Chicago Board of Trade for the first time in 1982. In Japan, the first bond options trading was conducted on the over-the-counter (OTC) market in the name of "trading in bonds with options" in April 1989. Trading in long-term

government bond futures options started in 1990, and trading in medium-term government note futures options (discontinued in 2002) started in 2000, both on the TSE.

Unlike bond futures trading, which are conducted on the basis of a benchmark issue, OTC bond options are traded on the basis of individual issues, such as government bonds, corporate bonds, or foreign bonds. Because they are traded on the OTC market, bond options agreements cannot be assigned to a third party (most of the transactions are for government bonds). As with government bond futures trading, bond options are traded in units of ¥100 million (\$1.1 million at the rate of ¥90 to the dollar) in par value. Because their life (from the date of contract to the date of delivery) is restricted to a maximum period of 1 year, and as they cannot be resold to a third party, contracts usually run a relatively long period—6 months or 1 year.

By contrast, long-term government bond futures options are available in the form of listed American options (the option can be exercised any day during its life), and their trading mechanism is similar to that of long-term government bond futures. Whereas long-term government bond futures have only three contract months with a maximum period of 9 months, long-term government bond futures options offer up to four contract months with a maximum period of 6 months. In addition, compared with OTC bond options, transactions in long-term government bond futures and long-term government bond futures options are concentrated in those with a short remaining life.

In Western countries where options trading have long been conducted, investors are quite familiar with the system. However, in Japan, where there is no custom of options trading, investors utilize options trading less often than futures trading. Particularly, the amount of long-term government bond futures options trading is far smaller than that of long-term government futures trading. This is because investors' interest is concentrated in outright transactions that deal only in options, and covered transactions are not made in conjunction with underlying assets (namely, long-term government bond futures). On the other hand, in conducting OTC bond options trading, investors follow the strategy of combining underlying assets with covered call or target buying.

VII. Fees and Costs

A. Standard Underwriting Fees Schedule for Public Offering Bonds

Table 7.1 Standard Underwriting Fees Schedule for Public Offering Bonds

(bps)	SSA	Corporate	
	(sub-sovereign and agencies)	Prime	Standard
2 years	12.5	12.5	30.0
3 years	17.5	17.5	35.0
5 years	22.5	22.5	40.0
7 years	27.5	27.5	40.0
10 years	30.0	30.0	45.0
12 years	30.0	30.0	45.0
15 years	35.0	35.0	50.0
30 years	47.5	47.5	60.0

Source: ABMF-J Member.

B. Book-Entry and Transfer Fees (JASDEC Account Holding Issuer, etc.)

From the rules concerning service fees applicable to the corporate bonds, etc. book-entry transfer system

Table 7.2 Short-Term Corporate Bonds-Participation in the System

Item of Service Fees	Parties to Pay	Service Contents	Rates
Account opening fees and system connection preparation fees	JASDEC Participants	Processing for opening accounts and setting up a system connection	(1) In the case where a party to pay newly becomes a JASDEC Participant: JPY 200,000 Provided, however, that, when two (2) or more Classified Accounts are opened with the same account name, the account opening fees and system connection preparation fees shall be JPY 200,000, increased by the amount calculated based on the rate set forth in (2) below for each of such Classified Accounts in excess of one (1).

continued on next page

Table 7.2 continuation

Item of Service Fees	Parties to Pay	Service Contents	Rates
			(2) In the case where Classified Accounts are opened (excluding the cases falling under (1) above): JPY 50,000 per account Provided, however, that, when Classified Accounts are opened with the same account name for the first time, the account opening fees and system connection preparation fees shall be the amount calculated based on JPY 50,000 per Classified Account to be opened, minus JPY 50,000.
System connection preparation fees	Issuers	Processing for Issuer registration	JPY 50,000
	Persons appointed as Issuing Agents/Paying Agents; except for persons who have already been appointed as Issuing Agents/Paying Agents	Processing for setting up a system connection	JPY 50,000
Terminal connection fees	All users of the Integrated Web Terminal (excluding Fund Settlement Corporations)	Use of system resources through a continuous terminal connection	The rate of fees for use of system when the number of user IDs of an operational user is one (1) or more but not more than five (5): JPY 10,000 per month, for each company The rate of fees for use of system when the number of user IDs of an operational user is six (6) or more: a. Rate applicable to five user IDs of them; JPY 10,000 per month, for each company b. Rate applicable to the number of user IDs in excess of five (5); JPY 1,000 per month, for each user ID in excess of five (5).
Fixed fees to be borne by Indirect Account Management Institutions	Parties approved as Indirect Account Management Institutions	Processing of the approval as Indirect Account Management Institutions	JPY 50,000, for each approval

Source: Japan Securities Depository Center, Inc.

Table 7.3 Short-Term Corporate Bonds-Book-Entry Transfer Businesses

Item of Service Fees	Parties to Pay	Service Contents	Rates
New record service fees	Issuers relating to the new record	Administration of the Information of the Issue and administration of the balance of issue from the time of issuance until the time of redemption	JPY 0.19 per 10,000 for JPY 1 of the subscription price (for each issue), for each subscription (annualized rate) The monthly amount shall be equal to the amount calculated based on the annualized service fee rate set forth above, multiplied by the number of calendar days during the issue period (including the Issue Date but excluding the Redemption Date) and divided by 365; provided, however, that, if the foregoing amount exceeds JPY 100,000, the monthly amount shall be JPY 100,000.
Book-entry transfer service fees	Issuers and Purchaser JASDEC Participants relating to the new record	Processing for increasing the details recorded in the Transfer Account Book	In the case of the DVP Settlement: JPY 100 per transaction
			In the case of the Non-DVP Settlement: JPY 50 per transaction

continued on next page

Table 7.3 continuation

Item of Service Fees	Parties to Pay	Service Contents	Rates
	Transferor JASDEC Participants and Transferee JASDEC Participants relating to the book-entry transfer	Processing for changing the details recorded in the Transfer Account Book	In the case of the DVP Settlement: JPY 100 per transaction Provided, however, that the rate of fees for the book-entry transfer implemented between the Classified Accounts of the same JASDEC Participant shall be JPY 50 per transaction.
			In the case of the Non-DVP Settlement: JPY 50 per transaction Provided, however, that the rate of fees for the book-entry transfer implemented between the Classified Accounts of the same JASDEC Participant shall be JPY 25 per transaction.
	Issuers and Obliteration Applicant JASDEC Participants relating to the obliteration	Processing for decreasing the details recorded in the Transfer Account Book	In the case of the DVP Settlement: JPY 100 per transaction
			In the case of the Non-DVP Settlement: JPY 50 per transaction
Purchase and cancellation service fees	Purchase and Cancellation Applicant JASDEC Participants	Processing for decreasing the balance in the Transfer Account Book through purchase and cancellation	JPY 50 per transaction
Account balance administration service fees	JASDEC Participants	Administration of the Transfer Account Book during the holding period	JPY 0.065 per 10,000 for JPY 1 of the monthly average account balance, for each JASDEC Participant (annualized rate) The monthly amount shall be equal to the amount calculated based on the annualized service fee rate set forth above, multiplied by the number of calendar days during the applicable month and divided by 365.

Source: Japan Securities Depository Center, Inc.

Table 7.4 Corporate Bonds-Participation in the System

Item of Service Fees	Parties to Pay	Service Contents	Rates
Account opening fees and system connection preparation fees	JASDEC Participants	Processing for opening accounts and setting up a system connection	(1) In the case where a party to pay newly becomes a JASDEC Participant: JPY 200,000 Provided, however, that, when two (2) or more sets (<i>kumi</i>) of the Classified Accounts are opened with the same account name, the account opening fees and system connection preparation fees shall be JPY 200,000, increased by the amount calculated based on the rate set forth in (2) below for each set (<i>kumi</i>) of the Classified Accounts in excess of one (1). In such case, Trust Account (1), Trust Account (2), Trust Account (3), Trust Account (4) and Trust Account (5) (hereinafter referred to as "Each Trust Account in the Holding Account") and Customer Account and Non-resident, Etc. Account (hereinafter referred to as "Customer Account, Etc.") shall be treated as having the same account name.
			(2) In the case where Classified Accounts are opened (excluding the cases falling under (1) above): JPY 50,000 per set (<i>kumi</i>) Provided, however, that, when Classified Accounts are opened with the same account name for the first time, the account opening fees and system connection preparation fees shall be the amount calculated on JPY 50,000 per set (<i>kumi</i>) of the Classified Accounts to be opened, minus JPY 50,000. In such case, Each Trust Account in the Holding Account and the Customer Account, Etc. shall be treated as having the same account name.
System connection preparation fees	Parties appointed as the Issuing Agents and the Paying Agents	Processing for setting up a system connection	JPY 50,000

continued on next page

Table 7.4 continuation

Item of Service Fees	Parties to Pay	Service Contents	Rates
Terminal connection fees	All users of the Integrated Web Terminal (excluding Fund Settlement Corporations)	Use of system resources through a continuous terminal connection	The rate of fees for use of system when the number of user IDs of an operational user is one (1) or more but not more than five (5): JPY 10,000 per month, for each company
			The rate of fees for use of system when the number of user IDs of an operational user is six (6) or more: a. Rate applicable to five user IDs of them; JPY 10,000 per month, for each company b. Rate applicable to the number of user IDs in excess of five (5); JPY 1,000 per month, for each user ID in excess of five (5)
Fixed fees to be borne by Indirect Account Management Institutions	Parties approved as Indirect Account Management Institutions	Processing of the approval as Indirect Account Management Institutions	JPY 50,000, for each approval

Source: Japan Securities Depository Center, Inc.

Table 7.5 Corporate Bonds-Book-Entry Transfer Businesses

Item of Service Fees	Parties to Pay	Service Contents	Rates
New record service fees	Issuers relating to the new record	(i) Administration of the Information of the Issue, (ii) administration of balance and (iii) notice to Paying Agents of information concerning the redemption and interest payment, from the issuance until the redemption	With respect to the total issue amount of each issue: (1) Rate applicable to the portion equal to or less than JPY 100,000,000: JPY 0.95 per 10,000 for JPY 1 (2) Rate applicable to the portion equal to or more than JPY 100,000,001 and less than or equal to JPY 500,000,000: 80% of the rate set forth in (1) above (3) Rate applicable to the portion equal to or more than JPY 500,000,001 and less than or equal to JPY 1,000,000,000: 60% of the rate set forth in (1) above (4) Rate applicable to the portion equal to or more than JPY 1,000,000,001 and less than or equal to JPY 5,000,000,000: 40% of the rate set forth in (1) above (5) Rate applicable to the portion equal to or more than JPY 5,000,000,001 and less than or equal to JPY 10,000,000,000: 20% of the rate set forth in (1) above (6) Rate applicable to the portion equal to or more than JPY 10,000,000,001 and less than or equal to JPY 50,000,000,000: 10% of the rate set forth in (1) above (7) Rate applicable to the portion equal to or more than JPY 50,000,000,001 and less than or equal to JPY 100,000,000,000: 5% of the rate set forth in (1) above (8) Rate applicable to the portion equal to or more than JPY 100,000,000,001: 2.5% of the rate set forth in (1) above
Book-entry transfer service fees	Transferor JASDEC Participants and Transferee JASDEC Participants relating to the book-entry transfer	Processing for changing the details recorded in the Transfer Account Book	In the case of the DVP Settlement: JPY 100 per transaction Provided, however, that the rate of service fees for the book-entry transfer implemented between the Classified Accounts of the same JASDEC Participant shall be JPY 50 per transaction. In the case of the Non-DVP Settlement: JPY 50 per transaction Provided, however, that the rate of service fees for the book-entry transfers implemented between the Classified Accounts of the same JASDEC Participant shall be JPY 25 per transaction.
Purchase and cancellation service fees	Purchase and Cancellation Applicant JASDEC Participants	Processing for decreasing the balance under the Transfer Account Book through purchase and cancellation	JPY 50 per transaction

continued on next page

Table 7.5 continuation

Item of Service Fees	Parties to Pay	Service Contents	Rates
Account balance administration service fees	JASDEC Participants	Administration of the Transfer Account Book during the holding period	<p>With respect to the monthly average account balance for each JASDEC Participant: (annualized rate)</p> <p>(1) Rate applicable to the portion equal to or less than JPY 500,000,000,000: JPY 0.065 per 10,000 for JPY 1</p> <p>(2) Rate applicable to the portion equal to or more than JPY 500,000,000,001 and less than or equal to JPY 1,000,000,000,000: 60% of the rate set forth in (1) above</p> <p>(3) Rate applicable to the portion equal to or more than JPY 1,000,000,000,001 and less than or equal to JPY 5,000,000,000,000: 40% of the rate set forth in (1) above</p> <p>(4) Rate applicable to the portion equal to or more than JPY 5,000,000,000,001 and less than or equal to JPY 10,000,000,000,000: 20% of the rate set forth in (1) above</p> <p>(5) Rate applicable to the portion equal to or more than JPY 10,000,000,000,001 and less than or equal to JPY 20,000,000,000,000: 10% of the rate set forth in (1) above</p> <p>(6) Rate applicable to the portion equal to or more than JPY 20,000,000,000,001 and less than or equal to JPY 30,000,000,000,000: 5% of the rate set forth in (1) above</p> <p>(7) Rate applicable to the portion equal to or more than JPY 30,000,000,000,001: 2.5% of the rate set forth in (1) above</p> <p>The monthly amount shall be equal to the amount calculated based on the annualized service fee rates set forth above, multiplied by the number of calendar days during the applicable month and divided by 365; provided, however, that, if the foregoing amount is less than JPY 100,000, the monthly amount shall be JPY 100,000.</p>
Portion			Rate and Amount
1.	Equal to or less than ¥100 million:		¥0.95 per 10,000 for ¥1 (Max: ¥9,500)
2.	Equal to or more than ¥100,000,001 and less than or equal to ¥500 million		80% of the rate set forth in (1) above (Max: ¥38,000)
3.	Equal to or more than ¥500,000,001 and less than or equal to ¥1 billion		60% of the rate set forth in (1) above (Max: ¥57,000)
4.	Equal to or more than ¥1,000,000,001 and less than or equal to ¥5 billion		40% of the rate set forth in (1) above (Max: ¥190,000)
5.	Equal to or more than ¥5,000,000,001 and less than or equal to ¥10 billion		20% of the rate set forth in (1) above (Max: ¥190,000)
6.	Equal to or more than ¥10,000,000,001 and less than or equal to ¥50 billion		10% of the rate set forth in (1) above (Max: ¥475,000)
7.	Equal to or more than ¥50,000,000,001 and less than or equal to ¥100 billion		5% of the rate set forth in (1) above (Max: ¥475,000)
8.	Equal to or more than ¥100,000,000,001		2.5% of the rate set forth in (1) above (Minimum: ¥237,500)

Source: Japan Securities Depository Center, Inc.

C. Fee to the Fiscal Agent and/or Paying Agent

Table 7.6 Standard Fee Rate for Fiscal Agent and/or Paying Agent

Fee Item	Portion/Rating	Rate
1. Coupon Payment Fee (one time: twice a year)	Total Outstanding Amounts	¥0.075 per 10,000 for ¥1
2. Redemption Fee	Total Redemption Amounts	¥0.075 per 10,000 for ¥1
3. Paying Agent for CP issuance and redemption	Per one payment	Several thousand yen per one issue/redemption
4. Agent Fee related to Bonds		
a. Fiscal Agent Annual Fee (Yearly) (Outstanding amount)	Total Outstanding Amounts (¥10 billion)	¥0.075 per 10,000 for ¥1 (¥75,000)
a. CCB (Commissioned Company for Bondholders) Fee	-AA	1 basis point (bp)/p.a. x Outstanding Amount
	A	2 bps/p.a. x Outstanding Amount
	BBB	4.5 bps/p.a. x Outstanding Amount
In case of the CCB attached bonds, both of above fees (a. +b.) will be charged.		
Source: ABMF-J Member.		

D. Standard Fiscal Agent Fee for Public Offering of Corporate Bonds

Table 7.7 Standard Fiscal Agent Fee for Public Offering of Corporate Bond

Maturity	Total Payable Amount in Case of Bond Size ¥10 billion
3 years	¥12 million
5 years	¥13 million
7 years	¥14 million
Source: ABMF-J Member.	

E. Others

Table 7.8 Other Fees and Costs

Item	Details
1. Credit Rating Fee	Credit rating fee will vary greatly depending on the target, content and the size.
2. Stamp Duty	The buyer pays a stamp duty of ¥200 per trade for physical certificate transfers. JASDEC-held securities are exempt from stamp duty.
3. Registration Costs	Registrars do not charge to register equity share certificates, but may pass on their agents' costs in terms of transporting and processing the registration documents. For bonds other than JGBs, registrars charge ¥800 to ¥1200 for registration per transaction.
Source: ABMF-J Member.	

VIII. Market Statistics

A. Overview

The total value of public and corporate bonds issued in fiscal 2010 (ending 31 March 2011) was ¥183.7 trillion. Of this amount, ¥151.1 trillion, or 82% of the total value, was accounted for by government bonds, underscoring their dominant presence in the public and corporate bond market in Japan.

Up until fiscal 2008, Japanese government bond (JGB) issuance had been on the decline along with the upswing in the central government’s financial position, but issuance mounts again given the deterioration in the government’s finances caused by the slump in the economy following the Lehman Shock in September 2008.

Figure 8.1 Issuance of Bonds by Type, FY 1990 to FY 2010 (¥ trillion)

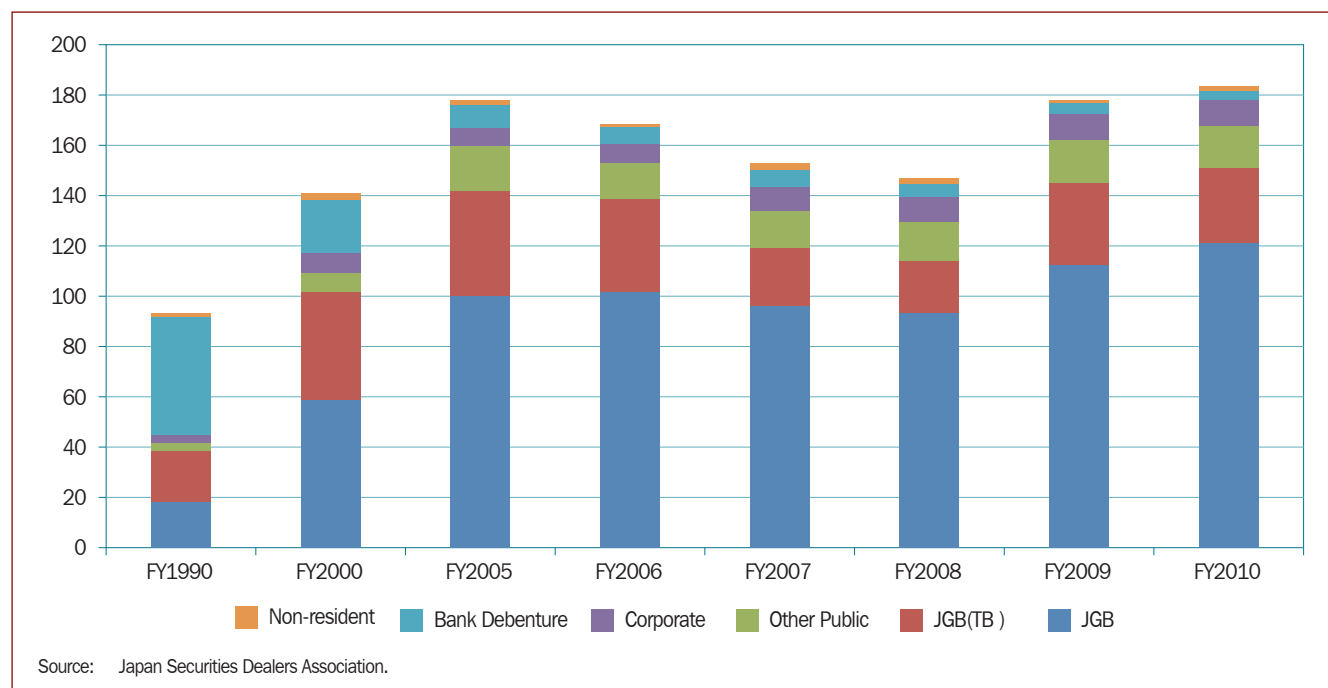

Table 8.1 Issuance of Bonds by Type, FY 1990 to FY 2010 (¥ trillion)

	FY1990	FY2000	FY2005	FY2006	FY2007	FY2008	FY2009	FY2010
JGB	18.3	58.8	100.1	101.8	96.4	93.2	112.4	121.1
JGB(TB)	20.5	42.8	41.9	36.8	22.8	21.0	32.9	30.0
Other Public	2.9	7.5	17.9	14.6	15.0	15.3	16.8	16.7
Corporate	3.4	8.3	7.4	7.5	9.6	9.9	10.6	10.1
Bank Debenture	46.9	21.0	8.8	6.7	6.5	5.5	4.2	3.8
Non-resident	1.4	2.6	1.6	0.8	2.6	2.1	1.2	1.9
Total	93.2	141.0	177.6	168.1	152.9	147.0	178.1	183.7
Notes: Other Public includes local government bonds and government agency bonds. Corporate etc. includes asset-backed bonds and convertible-type bonds.								
Source: Japan Securities Dealers Association.								

The amount of bank debentures issued in fiscal 2010 stood at ¥3.8 trillion, down largely from ¥46.9 trillion in fiscal 1990. This market movement suggests that the Japanese industry's dependency on long-term credit banks as a source of long-term capital has come to an end.

The total issue value of corporate bonds reached ¥10.1 trillion in fiscal 2010, keeping almost the same level for 4 consecutive years but occupying only 5.5% of the total bond issue value. The dematerialization of bonds issued in Japan put a temporary halt in the issuing market in 2006.

Meanwhile, once depressed in the aftermath of default on Argentine government debt in 2002, the issuance of yen-denominated foreign bonds was steadily recovering. Thereafter with certain ups and downs, the yen-denominated foreign bonds continue to be used as an important financing source for foreign issuers supported by their needs for the diversification of the currency risk in bond issuance. And because of a measure for credit enhancement called "GATE," which the Japan Bank for International Cooperation (JBIC) introduced in April 2010 to facilitate the new Samurai Bond issues, the total issue value of yen-denominated foreign bonds recovered to ¥1.9 trillion in fiscal 2010.

B. Outstanding Amount of Bonds Issued in Japan

Figure 8.2 Outstanding Amount of Bonds (¥ trillion)

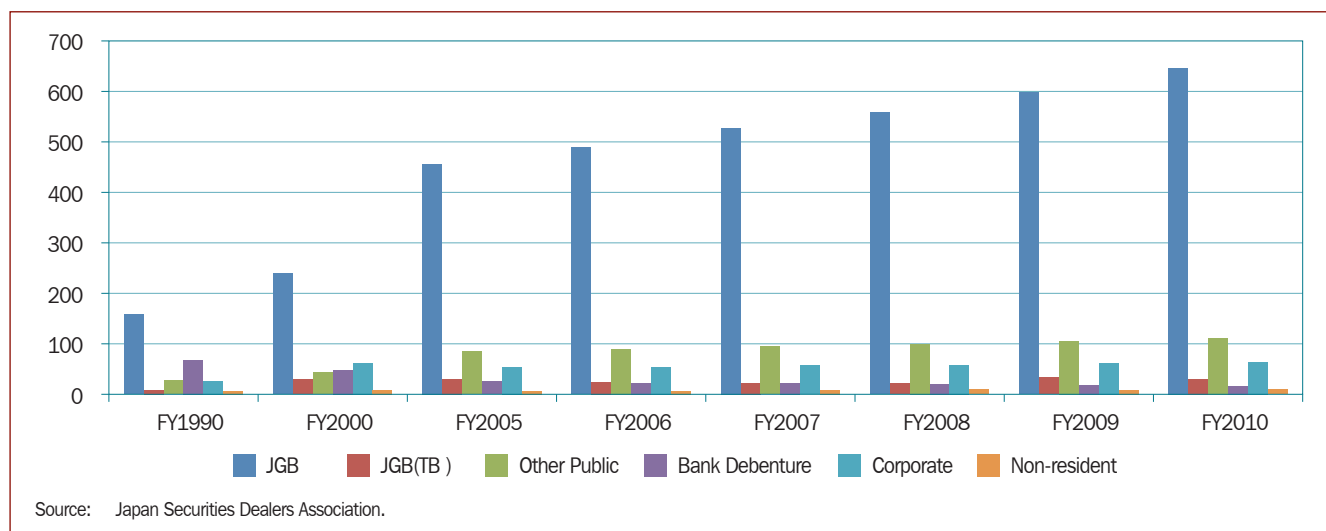

Figure 8.3 Outstanding Amount of Bonds (Percentage)

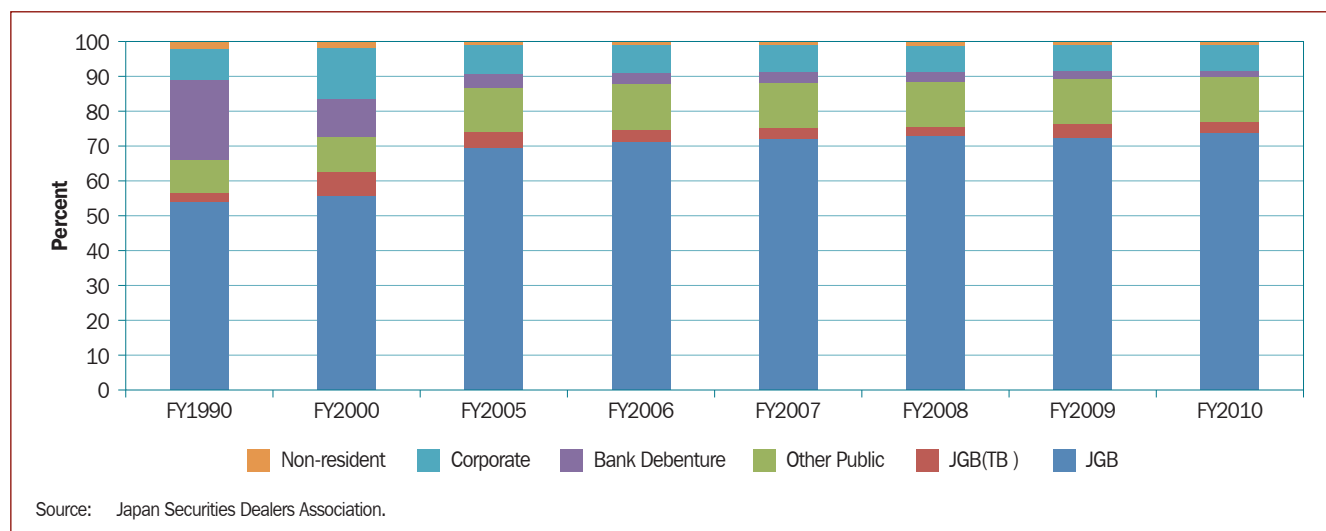

Table 8.2 Outstanding Amount of Bonds, FY 1990 to FY 2010 (¥ trillion)

	FY1990	FY2000	FY2005	FY2006	FY2007	FY2008	FY2009	FY2010
JGB	158.1	239.6	455.7	488.8	527.5	558.0	598.2	646.8
JGB (TB)	8.2	29.6	29.9	24.8	22.8	21.0	32.9	30.0
Other Public	27.1	42.9	84.5	89.2	94.4	99.1	105.8	111.5
Bank Debenture	67.7	48.2	25.5	22.9	22.0	20.9	18.9	16.7
Corporate etc.	26.0	61.9	54.5	54.3	56.7	58.1	61.4	64.0
Non-resident	6.0	8.2	6.7	6.5	8.1	9.3	9.0	9.5
Total	293.1	430.5	656.9	686.6	731.5	766.4	826.3	878.5

Source: Japan Securities Dealers Association.

C. Size of Local Currency Bond Market in U.S. Dollars

Table 8.3 Size of LCY Bond Market in USD (Local Sources)

Date	Govt (in USD Billions)	Corp (in USD Billions)	Total (in USD Billions)
Mar-98	2210.77	955.72	3166.49
Jun-98	2152.91	913.75	3066.66
Sep-98	2245.23	918.95	3164.18
Dec-98	2763.54	1093.59	3857.13
Mar-99	2774.72	1030.72	3805.44
Jun-99	2786.00	1020.99	3806.99
Sep-99	3243.76	1164.64	4408.41
Dec-99	3481.93	1209.39	4691.33
Mar-00	3593.62	1194.70	4788.32
Jun-00	3543.20	1151.18	4694.38
Sep-00	3576.00	1123.70	4699.71
Dec-00	3499.39	1053.14	4552.53
Mar-01	3249.07	936.77	4185.85
Jun-01	3429.45	953.91	4383.36
Sep-01	3724.84	980.42	4705.26
Dec-01	3529.78	882.27	4412.05
Mar-02	3646.14	844.37	4490.51
Jun-02	4195.30	924.39	5119.70
Sep-02	4255.01	889.03	5144.05
Dec-02	4503.57	897.54	5401.11
Mar-03	4670.36	875.34	5545.70
Jun-03	4724.96	852.10	5577.06
Sep-03	5221.11	885.71	6106.82
Dec-03	5541.83	907.14	6448.96
Mar-04	5883.32	913.25	6796.57
Jun-04	5807.90	864.38	6672.27
Sep-04	5906.54	835.63	6742.17
Dec-04	6556.28	891.14	7447.42
Mar-05	6497.34	831.55	7328.89
Jun-05	6426.45	792.01	7218.46
Sep-05	6389.37	769.63	7159.00
Dec-05	6301.63	743.68	7045.31
Mar-06	6374.52	736.68	7111.20
Jun-06	6547.67	749.03	7296.70
Sep-06	6405.61	713.58	7119.19
Dec-06	6389.38	706.94	7096.32
Mar-07	6448.51	710.78	7159.29
Jun-07	6153.55	688.45	6842.01
Sep-07	6639.39	746.86	7386.25
Dec-07	6874.22	773.10	7647.32
Mar-08	7779.36	870.14	8649.50
Jun-08	7319.51	822.76	8142.27
Sep-08	7291.62	826.60	8118.22

continued on next page

Table 8.3 continuation

Date	Govt (in USD Billions)	Corp (in USD Billions)	Total (in USD Billions)
Dec-08	8564.36	963.19	9527.55
Mar-09	7842.17	892.41	8734.58
Jun-09	8112.59	921.42	9034.01
Sep-09	8827.21	1001.28	9828.49
Dec-09	8655.57	964.17	9619.74
Mar-10	8794.24	956.15	9750.39
Jun-10	9465.66	1014.24	10479.90
Sep-10	10134.24	1076.72	11210.96
Dec-10	10605.84	1112.95	11718.78
Mar-11	10418.08	1085.63	11503.71
Jun-11	10887.29	1103.96	11991.25

Source: Asian Development Bank, AsianBondsOnline. http://asianbondsonline.adb.org/japan/data/bondmarket.php?code=LCY_in_USD_Local

D. Size of Local Currency Bond Market in Percentage of Gross Domestic Product

Table 8.4 Size of Local Currency Bond Market (Local Sources) (% GDP)

Date	Govt (in %GDP)	Corp (in %GDP)	Total (in %GDP)	Govt (in USD Billions)	Corp (in USD Billions)	Total (in USD Billions)
Mar-98	57.3	24.8	82.0	2210.77	955.72	3166.49
Jun-98	58.5	24.8	83.4	2152.91	913.75	3066.66
Sep-98	60.3	24.7	85.0	2245.23	918.95	3164.18
Dec-98	62.2	24.6	86.8	2763.54	1093.59	3857.13
Mar-99	65.5	24.3	89.9	2774.72	1030.72	3805.44
Jun-99	67.2	24.6	91.8	2786.00	1020.99	3806.99
Sep-99	69.0	24.8	93.8	3243.76	1164.64	4408.41
Dec-99	71.7	24.9	96.6	3481.93	1209.39	4691.33
Mar-00	73.9	24.6	98.5	3593.62	1194.70	4788.32
Jun-00	75.2	24.4	99.6	3543.20	1151.18	4694.38
Sep-00	77.0	24.2	101.3	3576.00	1123.70	4699.71
Dec-00	79.6	24.0	103.6	3499.39	1053.14	4552.53
Mar-01	81.4	23.5	104.9	3249.07	936.77	4185.85
Jun-01	84.9	23.6	108.5	3429.45	953.91	4383.36
Sep-01	88.8	23.4	112.1	3724.84	980.42	4705.26
Dec-01	93.4	23.3	116.7	3529.78	882.27	4412.05
Mar-02	98.0	22.7	120.7	3646.14	844.37	4490.51
Jun-02	102.0	22.5	124.5	4195.30	924.39	5119.70
Sep-02	105.5	22.0	127.6	4255.01	889.03	5144.05
Dec-02	108.9	21.7	130.6	4503.57	897.54	5401.11
Mar-03	112.6	21.1	133.7	4670.36	875.34	5545.70
Jun-03	115.5	20.8	136.3	4724.96	852.10	5577.06
Sep-03	118.8	20.2	139.0	5221.11	885.71	6106.82
Dec-03	121.2	19.8	141.0	5541.83	907.14	6448.96
Mar-04	124.2	19.3	143.5	5883.32	913.25	6796.57
Jun-04	127.4	19.0	146.4	5807.90	864.38	6672.27

continued on next page

Table 8.4 continuation

Date	Govt (in %GDP)	Corp (in %GDP)	Total (in %GDP)	Govt (in USD Billions)	Corp (in USD Billions)	Total (in USD Billions)
Sep-04	130.6	18.5	149.1	5906.54	835.63	6742.17
Dec-04	135.0	18.4	153.4	6556.28	891.14	7447.42
Mar-05	139.7	17.9	157.5	6497.34	831.55	7328.89
Jun-05	142.7	17.6	160.2	6426.45	792.01	7218.46
Sep-05	144.9	17.5	162.4	6389.37	769.63	7159.00
Dec-05	147.9	17.5	165.3	6301.63	743.68	7045.31
Mar-06	149.2	17.2	166.5	6374.52	736.68	7111.20
Jun-06	148.6	17.0	165.6	6547.67	749.03	7296.70
Sep-06	149.8	16.7	166.5	6405.61	713.58	7119.19
Dec-06	149.9	16.6	166.5	6389.38	706.94	7096.32
Mar-07	148.7	16.4	165.1	6448.51	710.78	7159.29
Jun-07	147.7	16.5	164.2	6153.55	688.45	6842.01
Sep-07	148.1	16.7	164.8	6639.39	746.86	7386.25
Dec-07	149.0	16.8	165.8	6874.22	773.10	7647.32
Mar-08	150.4	16.8	167.2	7779.36	870.14	8649.50
Jun-08	151.4	17.0	168.4	7319.51	822.76	8142.27
Sep-08	151.7	17.2	168.9	7291.62	826.60	8118.22
Dec-08	153.9	17.3	171.2	8564.36	963.19	9527.55
Mar-09	157.7	17.9	175.7	7842.17	892.41	8734.58
Jun-09	161.7	18.4	180.1	8112.59	921.42	9034.01
Sep-09	166.4	18.9	185.2	8827.21	1001.28	9828.49
Dec-09	171.0	19.0	190.0	8655.57	964.17	9619.74
Mar-10	173.4	18.9	192.3	8794.24	956.15	9750.39
Jun-10	176.1	18.9	195.0	9465.66	1014.24	10479.90
Sep-10	176.9	18.8	195.7	10134.24	1076.72	11210.96
Dec-10	179.5	18.8	198.4	10605.84	1112.95	11718.78
Mar-11	182.0	19.0	201.0	10418.08	1085.63	11503.71
Jun-11	185.8	18.8	204.7	10887.29	1103.96	11991.25

Source: Asian Development Bank, AsianBondsOnline, http://asianbondsonline.adb.org/japan/data/bondmarket.php?code=LCY_in_GDP_Local

E. Size of Foreign Currency Bond Market in U.S. Dollars (Bank for International Settlement)

Table 8.5 Foreign Currency Bonds (BIS) (\$ billions)

Date	FCY Denominated Bonds (in USD billions)
Dec-95	230.4
Dec-96	197.4
Dec-97	155.0
Dec-98	132.9
Dec-99	124.7
Dec-00	105.0
Dec-01	95.2
Dec-02	104.2
Dec-03	119.5
Mar-04	125.5

continued on next page

Table 8.5 continuation

Date	FCY Denominated Bonds (in USD billions)
Jun-04	131.5
Sep-04	131.2
Dec-04	141.1
Mar-05	141.1
Jun-05	139.7
Sep-05	143.5
Dec-05	140.1
Mar-06	144.8
Jun-06	149.9
Sep-06	149.4
Dec-06	151.2
Mar-07	150.7
Jun-07	149.6
Sep-07	157.8
Dec-07	164.1
Mar-08	179.8
Jun-08	177.4
Sep-08	175.7
Dec-08	185.2
Mar-09	169.2
Jun-09	167.7
Sep-09	174.4
Dec-09	170.6
Mar-10	171.1
Jun-10	168.0
Sep-10	182.5
Dec-10	183.6
Mar-11	184.6

Source: Asian Development Bank, AsianBondsOnline. http://asianbondsonline.adb.org/japan/data/bondmarket.php?code=FCY_in_USD

F. Size of FCY Bond Market in Percentage of Gross Domestic Product (Bank for International Settlement)

Table 8.6 Foreign Currency Bonds to Gross Domestic Product Ratio

Date	as % of GDP	FCY Denominated Bonds (in USD billions)	GDP (in USD billions)
Dec-95	4.8	230.4	4768.5
Dec-96	4.5	197.4	4350.8
Dec-97	3.9	155.0	3946.2
Dec-98	3.0	132.9	4444.6
Dec-99	2.6	124.7	4854.4
Dec-00	2.4	105.0	4396.4
Dec-01	2.5	95.2	3780.3

continued on next page

Table 8.6 continuation

Date	as % of GDP	FCY Denominated Bonds (in USD billions)	GDP (in USD billions)
Dec-02	2.5	104.2	4136.0
Dec-03	2.6	119.5	4572.8
Mar-04	2.6	125.5	4737.6
Jun-04	2.9	131.5	4557.2
Sep-04	2.9	131.2	4522.0
Dec-04	2.9	141.1	4855.6
Mar-05	3.0	141.1	4652.3
Jun-05	3.1	139.7	4504.8
Sep-05	3.3	143.5	4408.5
Dec-05	3.3	140.1	4261.0
Mar-06	3.4	144.8	4272.3
Jun-06	3.4	149.9	4406.3
Sep-06	3.5	149.4	4276.2
Dec-06	3.5	151.2	4261.8
Mar-07	3.5	150.7	4336.2
Jun-07	3.6	149.6	4165.9
Sep-07	3.5	157.8	4482.3
Dec-07	3.6	164.1	4613.2
Mar-08	3.5	179.8	5174.1
Jun-08	3.7	177.4	4835.4
Sep-08	3.7	175.7	4807.2
Dec-08	3.3	185.2	5564.6
Mar-09	3.4	169.2	4972.4
Jun-09	3.3	167.7	5017.3
Sep-09	3.3	174.4	5305.2
Dec-09	3.4	170.6	5062.2
Mar-10	3.4	171.1	5071.5
Jun-10	3.1	168.0	5375.5
Sep-10	3.2	182.5	5729.5
Dec-10	3.1	183.6	5907.5
Mar-11	3.2	184.6	5722.8

Source: Asian Development Bank, AsianBondsOnline, http://asianbondsonline.adb.org/japan/data/bondmarket.php?code=FCY_in_GDP

G. Size of Foreign Currency Bond Market in U.S. Dollars (Local Sources)

Table 8.7 Foreign Currency Bonds Outstanding (Local Sources) (\$ billions)

Date	Government	Banks and Financial Institutions	Other Corporates	Total Foreign Currency
Mar-04	25.11	10.48	16.92	52.51
Jun-04	26.23	10.28	18.84	55.35
Sep-04	24.79	10.51	17.70	52.99
Dec-04	25.77	9.98	18.41	54.16
Mar-05	24.58	10.95	17.77	53.30
Jun-05	25.32	10.44	17.16	52.91

continued on next page

Table 8.7 continuation

Date	Government	Banks and Financial Institutions	Other Corporates	Total Foreign Currency
Sep-05	24.57	16.97	16.33	57.87
Dec-05	24.73	18.17	15.93	58.84
Mar-06	25.04	24.91	16.77	66.72
Jun-06	25.47	26.14	16.28	67.89
Sep-06	25.41	31.40	14.28	71.09
Dec-06	23.68	38.08	15.52	77.28
Mar-07	24.50	40.57	13.33	78.40
Jun-07	25.11	42.33	12.44	79.87
Sep-07	24.21	43.60	12.05	79.86
Dec-07	25.63	43.66	11.89	81.19
Mar-08	27.33	44.80	11.56	83.69
Jun-08	27.38	46.48	11.49	85.35
Sep-08	25.61	45.90	10.32	81.83
Dec-08	25.51	44.24	9.92	79.67
Mar-09	24.40	45.48	9.46	79.34
Jun-09	26.54	47.27	8.78	82.60
Sep-09	26.86	48.42	8.98	84.26
Dec-09	28.21	49.92	8.96	87.09
Mar-10	29.24	25.45	6.56	61.25
Jun-10	30.48	57.95	8.41	96.84
Sep-10	29.94	58.91	17.15	106.01
Dec-10	29.83	58.03	19.54	107.40
Mar-11	33.59	70.85	7.31	111.75

Source: Asian Development Bank, AsianBondsOnline, http://asianbondsonline.adb.org/japan/data/bondmarket.php?code=FCY_Bonds_Outstanding

H. Foreign Holdings in Local Currency Government Bonds

Table 8.8 Foreign Holdings in LCY Government Bonds (¥ billions)

Date	Foreign Holdings	Total	% of Total
Mar-98	18329.8	299330.9	6.12
Jun-98	20168.6	304280.9	6.63
Sep-98	22855.7	322506.1	7.09
Dec-98	27311.6	319853.5	8.54
Mar-99	27388.0	339031.7	8.08
Jun-99	22255.0	340901.1	6.53
Sep-99	22679.8	351270.9	6.46
Dec-99	18355.3	358662.7	5.12
Mar-00	18518.7	366534.6	5.05
Jun-00	23578.8	371657.8	6.34
Sep-00	25216.5	376972.5	6.69
Dec-00	23262.8	391080.7	5.95
Mar-01	24287.4	408789.0	5.94
Jun-01	23826.0	425186.1	5.60
Sep-01	22495.9	436887.9	5.15

continued on next page

Table 8.8 continuation

Date	Foreign Holdings	Total	% of Total
Dec-01	21596.4	451665.3	4.78
Mar-02	16539.3	469271.7	3.52
Jun-02	17259.1	487917.4	3.54
Sep-02	18181.9	504534.8	3.60
Dec-02	16812.8	519791.5	3.23
Mar-03	17407.2	537762.7	3.24
Jun-03	16903.8	546794.8	3.09
Sep-03	14527.0	545420.9	2.66
Dec-03	16708.1	556416.9	3.00
Mar-04	19648.9	570718.7	3.44
Jun-04	19856.6	577944.7	3.44
Sep-04	23468.5	599219.8	3.92
Dec-04	25668.6	618862.3	4.15
Mar-05	26386.5	641809.7	4.11
Jun-05	30392.9	659216.6	4.61
Sep-05	29455.9	658626.5	4.47
Dec-05	31331.5	672305.7	4.66
Mar-06	30231.9	667328.0	4.53
Jun-06	34899.0	658792.1	5.30
Sep-06	34473.0	674981.4	5.11
Dec-06	37325.8	675523.0	5.53
Mar-07	40208.2	672703.0	5.98
Jun-07	37114.5	660587.1	5.62
Sep-07	41063.0	669646.6	6.13
Dec-07	47931.3	682772.3	7.02
Mar-08	47372.7	694998.4	6.82
Jun-08	48006.2	683680.6	7.02
Sep-08	52928.9	682108.3	7.76
Dec-08	44990.5	696747.9	6.46
Mar-09	43949.5	680869.8	6.45
Jun-09	41357.5	674845.3	6.13
Sep-09	39647.0	678676.6	5.84
Dec-09	34673.8	679311.8	5.10
Mar-10	31631.4	682052.1	4.64
Jun-10	32951.8	708486.0	4.65
Sep-10	37049.4	725748.4	5.10
Dec-10	35918.4	727959.6	4.93
Mar-11	36510.6	726268.0	5.03

Source: Asian Development Bank, AsianBondsOnline. http://asianbondsonline.adb.org/japan/data/bondmarket.php?code=Foreign_Holdings

I. Domestic Financing Profile

Table 8.9 Domestic Financing Profile

Date	Domestic Credit (% of Total)	Bonds (% of Total)	Equity (% of Total)	Domestic Credit (in \$ billions)	Bonds (in \$ billions)	Equity (in \$ billions)	Total (in \$ billions)
Dec-00	0	59.05	40.95	0	4552.53	3157.22	7709.75
Dec-01	57.60	28.02	14.38	9069.83	4412.05	2264.53	15746.41
Dec-02	56.70	31.31	11.99	9781.71	5401.11	2069.30	17252.12
Dec-03	53.71	31.75	14.54	10910.66	6448.97	2953.10	20312.73
Dec-04	50.61	33.43	15.97	11275.46	7447.42	3557.67	22280.55
Dec-05	45.71	32.92	21.37	9782.90	7045.31	4572.90	21401.11
Dec-06	44.49	33.64	21.87	9387.00	7096.32	4614.07	21097.39
Mar-07	44.40	33.46	22.14	9501.32	7159.29	4737.54	21398.15
Jun-07	43.67	33.45	22.88	8933.79	6842.00	4681.05	20456.84
Sep-07	44.40	34.35	21.25	9546.21	7386.25	4569.15	21501.62
Dec-07	44.92	35.16	19.91	9769.09	7647.32	4330.92	21747.33
Mar-08	46.53	36.65	16.83	10981.76	8649.5	3971.39	23602.66
Jun-08	45.58	36.37	18.06	10204.86	8142.27	4042.79	22389.92
Sep-08	47.03	37.55	15.42	10167.38	8118.22	3334.41	21620.01
Dec-08	49.19	38.29	12.52	12239.04	9527.55	3115.80	24882.40
Mar-09	49.39	38.96	11.65	11071.96	8734.58	2610.66	22417.20
Jun-09	48.32	38.15	13.53	11440.95	9034.01	3203.51	23678.47
Sep-09	48.29	38.38	13.33	12366.34	9828.49	3413.35	25608.18
Dec-09	48.29	38.49	13.23	12069.29	9619.74	3306.08	24995.11
Mar-10	47.50	38.53	13.97	12018.87	9750.50	3534.69	25304.06
Jun-10	48.14	39.51	12.36	12768.33	10480.01	3277.30	26525.65
Sep-10	48.20	39.69	12.12	13615.13	11211.08	3423.74	28249.95
Dec-10	47.45	39.62	12.94	14039.00	11722.90	3827.77	29589.68
Mar-11	0	76	24	0	11512.83	3634.79	15147.62

Source: Asian Development Bank, AsianBondsOnline, http://asianbondsonline.adb.org/japan/data/bondmarket.php?code=Domestic_Financing_profile

J. Trading Volume

Table 8.10 Trading Volume (\$ billions)

Year	Govt Bonds	Corp Bonds	Total
Mar-99	2934.45	65.06	2999.51
Jun-99	4448.98	58.39	4507.37
Sep-99	4979.03	69.43	5048.46
Dec-99	4492.24	67.82	4560.06
Mar-00	4306.39	88.56	4394.95
Jun-00	4824.48	106.83	4931.31
Sep-00	4417.15	105.14	4522.29
Dec-00	4704.77	100.88	4805.65
Mar-01	3801.78	111.31	3913.09
Jun-01	4292.83	109.15	4401.98
Sep-01	4096.92	95.11	4192.03
Dec-01	3399.44	122.50	3521.94

continued on next page

Table 8.10 continuation

Year	Govt Bonds	Corp Bonds	Total
Mar-02	2877.31	122.21	2999.52
Jun-02	3848.96	127.63	3976.59
Sep-02	3780.42	119.53	3899.95
Dec-02	3758.50	131.9	3890.40
Mar-03	4228.12	131.19	4359.31
Jun-03	5348.85	138.46	5487.31
Sep-03	6161.63	150.66	6312.29
Dec-03	6010.11	136.35	6146.46
Mar-04	6572.17	148.55	6720.72
Jun-04	7451.95	158.75	7610.70
Sep-04	7641.00	155.31	7796.31
Dec-04	7933.90	176.57	8110.47
Mar-05	7107.04	156.74	7263.78
Jun-05	7349.86	145.05	7494.91
Sep-05	7445.76	145.11	7590.87
Dec-05	7402.82	130.00	7532.82
Mar-06	8462.15	129.66	8591.81
Jun-06	10361.46	142.38	10503.84
Sep-06	9419.71	96.87	9516.58
Dec-06	10155.32	69.42	10224.74
Mar-07	11305.20	73.00	11378.20
Jun-07	11999.13	77.44	12076.57
Sep-07	13635.97	81.09	13717.06
Dec-07	14489.81	86.45	14576.26
Mar-08	15545.71	100.64	15646.35
Jun-08	14076.61	88.74	14165.35
Sep-08	12547.80	81.20	12629.00
Dec-08	13442.04	113.93	13555.97
Mar-09	11763.39	93.50	11856.89
Jun-09	10908.12	70.85	10978.97
Sep-09	11511.81	58.66	11570.47
Dec-09	10776.30	53.89	10830.19
Mar-10	8984.88	55.33	9040.21
Jun-10	10530.51	84.85	10615.36
Sep-10	11886.53	79.73	11966.26
Dec-10	12122.52	75.81	12198.33
Mar-11	11108.42	75.56	11183.98
Jun-11	12245.31	94.28	12339.59

Source: Asian Development Bank, AsianBondsOnline. http://asianbondsonline.adb.org/japan/data/bondmarket.php?code=Trading_Volume

IX. Islamic Finance in Japan

A. Background on Introducing Islamic Finance in Japan

Japan has strong economic ties with Islamic countries, particularly Middle East oil producing countries, which are demonstrated by huge cash outflow from Japan to those countries every year. Facilitating the reverse flow of investment from Islamic countries towards Japan and other Asian regions is very meaningful for a balanced growth of the global economy, particularly in the age of high oil price.

In 2007, a number of Japanese public and private institutions started to explore Islamic finance as one of the means to attract Islamic investors (particularly those who are awash with petrodollar) to invest in Japan by participating in the Islamic Financial Services Board (IFSB), an international standard-setting organization for the Islamic finance services industry headquartered in Kuala Lumpur, Malaysia, as observer (see Table 9.1).

Table 9.1 Japanese Organizations in the Islamic Financial Services Board

Name	Nationality	Member Status
Bank of Japan	Japan	Observer Member
Bank of Tokyo-Mitsubishi (Malaysia)	Malaysia	Observer Member
Japan Bank for International Cooperation	Japan	Observer Member
Japan Securities Dealers Association	Japan	Observer Member
Mizuho Corporate Bank	Japan	Observer Member
Nomura Asset Management Malaysia	Malaysia	Observer Member
Nomura Securities	Japan	Observer Member
Sumitomo Mitsui Banking Corporation	Japan	Observer Member
(8 institutions)		

Source: Japan Securities Dealers Association.

In terms of private transactions, in addition to the early commitment of Tokio Marine Group to the Takaful operations since the beginning of this century, a couple of Japanese companies and their overseas subsidiaries have carried out Islamic capital market transactions overseas as follows:

1. Each Malaysian subsidiary of ION Credit Service and Toyota Financial Service issued Malaysia ringgit-denominated *Sukuk al Musharakah* in 2007 and 2008, respectively.
2. Daiwa Asset Management arranged the listing of the first Shari'ah compliant exchange-traded fund (ETF) for Japanese stocks in Singapore in 2008.
3. Nomura Holdings issued the first US dollar-denominated *Sukuk al Ijarah* (\$100 million) in July 2010 in Malaysia based on aircraft leasing.
4. Daiwa Securities Capital Markets acted as co-lead arranger for Islamic real-estate investment trusts (REIT) listed on the Singapore Exchange (SGX) in November 2010.

B. Regulatory Framework for Islamic Finance in General

For the time being, Japan is not equipped with a full-ranged regulatory framework for operating Islamic finance. However, in December 2008, the Japanese banking and insurance business regulation was relaxed to allow subsidiaries of Japanese banks and insurance companies to provide certain Islamic finance services in such forms as *Murabahah* (cost-plus sale) or *Ijarah* (leasing) by amending the *Ordinance for Enforcement of the Banking Law* and the *Insurance Business Law*.

At present, there is not an explicit movement for Japanese banks to set up such subsidiaries in Japan, except for a few cases where subsidiaries of Japanese banks are applying for the regulatory authorization required for conducting Islamic financial operations in overseas. Consequently, issues of Shari'ah compliance, or that of supervision of the market, have not yet been taken up for discussion in Japan.

C. Regulatory and Legal Framework for Islamic Bonds (Sukuk)

1. Background on the Amendment of Legislation for Fostering Sukuk Market in Japan

In 2010, further steps were contemplated to facilitate Sukuk issuance by Japanese domestic corporations (or other public or quasi-public entities) under the Japanese legal system. Since the latter half of 2010, the momentum within the governmental agency, Japan Financial Services Agency (J-FSA) became explicit such as:

- a. Recommendation by expert advisory group within J-FSA (July 2010) that “[i]t would be necessary to improve the tax treatment of Islamic finance by taking certain measures such as treating the dividends on Sukuk in the same manner as interests on bonds.”
Interests on book-entry bonds paid to non-residents and foreign entities are excluded from taxation following the tax reform in 2010.
- b. Policy assessment by J-FSA (August 2010);
- c. Submission of the tax reform request by the J-FSA (August 2010) (“Tax Reform Request”);
- d. Assessment and acceptance of the Tax Reform Request by Tax Commission (December 2010);

- e. Outline of the tax reform 2011 announced by the government (December 2010) (“Tax Reform Outline 2011”); and
- f. Action Plan for Japan’s New Growth Strategy, announced by the FSA on 24 December 2010: “the FSA will promote the development of the environment for Islamic bond issuance in Japan.”

2. Amendment of Legislation for Issuing Sukuk under Japanese Law

Following the momentum described above, National Diet passed a bill on 17 May 2011 to facilitate Sukuk issuance in Japan by way of amendment of the *Asset Securitization Act* (*shisan ryudoka ho* 「資産流動化法」). The bill is accompanied by amendments on relevant tax legislation with a view to creating a level tax playing field compared to conventional bonds.

A bill entitled “The Financial Instruments and Exchange Act (Amendment) for Reinforcement of Infrastructure of the Capital Market and Financial Business” (or the Bill), was presented before the National Diet on 1 April 2011 by the government of Japan. The bill involves an amendment of the *Asset Securitization Act* which anticipates accommodating a legal framework for the issuance of Sukuk, particularly Sukuk Ijarah, in Japan. The Sukuk Ijarah, under the new legal framework, will be established typically by taking the form of (Special) Bond-Type Beneficial Interests (*tokubetu shasai-teki jueki-ken* 「特別社債の受益権」) to be issued under the architecture of a specific purpose trust (*tokutei mokuteki shintaku* 「特定目的信託」) (SPT) pursuant to the amended *Asset Securitization Act*. The outline of the structure is illustrated below; whereby steps are taken in the manner illustrated in Figure 9.1. The (Special) Bond-Type Beneficial Interest is a certain type of beneficial interest under a SPT, for which a predetermined amount of money is distributed and a condition is attached to the effect that the originator shall purchase (buy back) the underlying assets or such other terms to be prescribed in the Cabinet Order.

Figure 9.1 Issuance Scheme

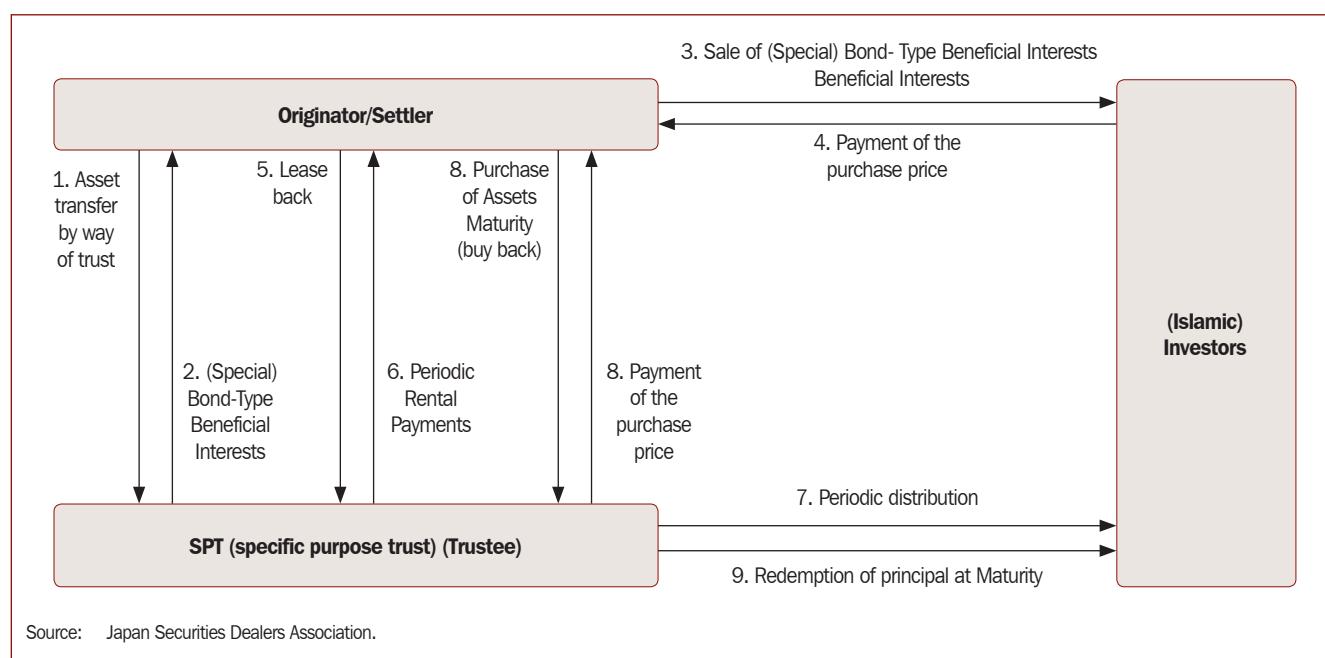

- (1) A Japanese institution acting as the originator (or settler in the context of the SPT Agreement) and a trustee, which would typically be a trust bank, enter into a specific purpose trust agreement (SPT Agreement) whereby the originator transfers the ownership of an asset (such as real estate, “Underlying Asset”) to the trustee who holds the same on trust.
- (2) The originator acquires (Special) Bond-Type Beneficial Interests in exchange for the transfer of the Underlying Asset to the trustee pursuant to the SPT Agreement.
- (3) The originator sells the (Special) Bond-Type Beneficial Interests to investors that include Islamic investors.
- (4) Investors pay the amount equivalent to the purchase price for the (Special) Bond-Type Beneficial Interests to the originator.
- (5) The originator enters into an Ijarah lease agreement with the trustee in respect of the Underlying Asset.
- (6) The originator makes periodic rental payments to the trustee under the Ijarah lease agreement.
- (7) The trustee makes periodic distribution of the profit to the investors by way of dividends on the (Special) Bond-Type Beneficial Interests, which are funded by the rental payments under the Ijarah lease agreement.
- (8) At maturity, the originator purchases (buys back) the Underlying Asset at a predetermined price equivalent to the (Special) Bond-Type Beneficial Interests amount then outstanding.
- (9) The trustee redeems the (Special) Bond-Type Beneficial Interests by utilizing the purchase price received from the originator.

In order for an instrument to fall within the definition of the (Special) Bond-Type Beneficial Interests under the new Art. 230 of the *Asset Securitization Act*, it needs to have all the following key characteristics:

- a. Amount of distribution.** The amount of distribution must be set out in the SPT Agreement in the form of a pre-determined amount or such other calculation whose method is to be prescribed in the Cabinet Order, which deems to result a pre-determined amount.²³
- b. Structure of payments.** The principal must be redeemed at a pre-determined point in time. The payment structure must allow not only payment at the end of the Sukuk term but also in installments.
- c. Voting rights.** The holders of the (Special) Bond-Type Beneficial Interests are not granted voting rights save for prescribed resolutions such as amendment and termination of the SPT Agreement.
- d. Asset-based nature (rather than asset backed).** The credit standing of the originator (i.e., the settler of the SPT) should have a material effect on the investment decision of the investors. On the face of the provision of the *Asset Securitization Act*, the asset-based nature of the (Special) Bond-Type Beneficial Interests is recognized by a purchase undertaking of the Underlying Asset by the originator under the SPT Agreement or other alternative arrangements to

²³ The draft Cabinet Order has not yet been disclosed to the public as of 11 July 2011 but is expected to allow periodic distribution determined by reference to market rate of interest such as Libor.

be prescribed in the Cabinet Order (which would likely be an arrangement where the Underlying Assets are recognized in the balance sheet of the originator, regardless of the transfer of its ownership to the trustee pursuant to the SPT Agreement).

3. Recognition of Sukuk Established or Issued under Foreign Law

It has not been explicitly reported that the Sukuks issued under overseas jurisdiction have been offered in Japan. Some factors that are attributable to the above include uncertainty of tax treatment, a lack of market demand within Japan which has little Muslim population, and challenges over regulatory definitions of overseas Islamic products.

D. Type of Instruments Available, Segments, and Tenure

The (Special) Bond-Type Beneficial Interests (which is anticipated to be recognised as “Sukuk” by Islamic investors) introduced in the recently amended *Asset Securitization Act* aim typically at the issuance of the Sukuk al Ijarah within the context of Japanese legislation.

E. Tax-Related Issues

There are four key measures in the amendment of the relevant tax legislation to address taxation issues that would otherwise put the (Special) Bond-Type Beneficial Interests at a disadvantage in view of conventional bond issues:

1. Exclusion from Taxation on the Distribution of Profits

The distributions of profit on the book-entry (Special) Bond-Type Beneficial Interests payable to:

- a. Foreign corporations and non-residents (who do not have permanent establishment in Japan) shall be excluded from taxation, and
- b. Domestic banks and other Japanese financial institutions shall be exempted from withholding tax.

2. Tax Transparency of the Special Purpose Trust

The conditions for deductibility of dividends paid by the SPT have been amended to the effect that the (Special) Bond-Type Beneficial Interests have been exempted from the requirement that more than 50% of the issue amount must be offered domestically.

3. Exclusion of Asset Transfer-Related Tax

The purchase (buy back) transaction of the Underlying Asset from SPT to the originator (or the settler of the SPT) shall be excluded from:

- a. Registration license tax; and
- b. Real estate acquisition tax (in respect of the SPT involving real estate as an underlying trust asset) in relation to the (Special) Bond-Type Beneficial Interests under the SPT.

4. Exemption from Capital Gain Tax

Foreign corporations shall be exempted from capital gain tax upon the secondary sale of the (Special) Bond-Type Beneficial Interests.

Figure 9.2 New Taxation Measures

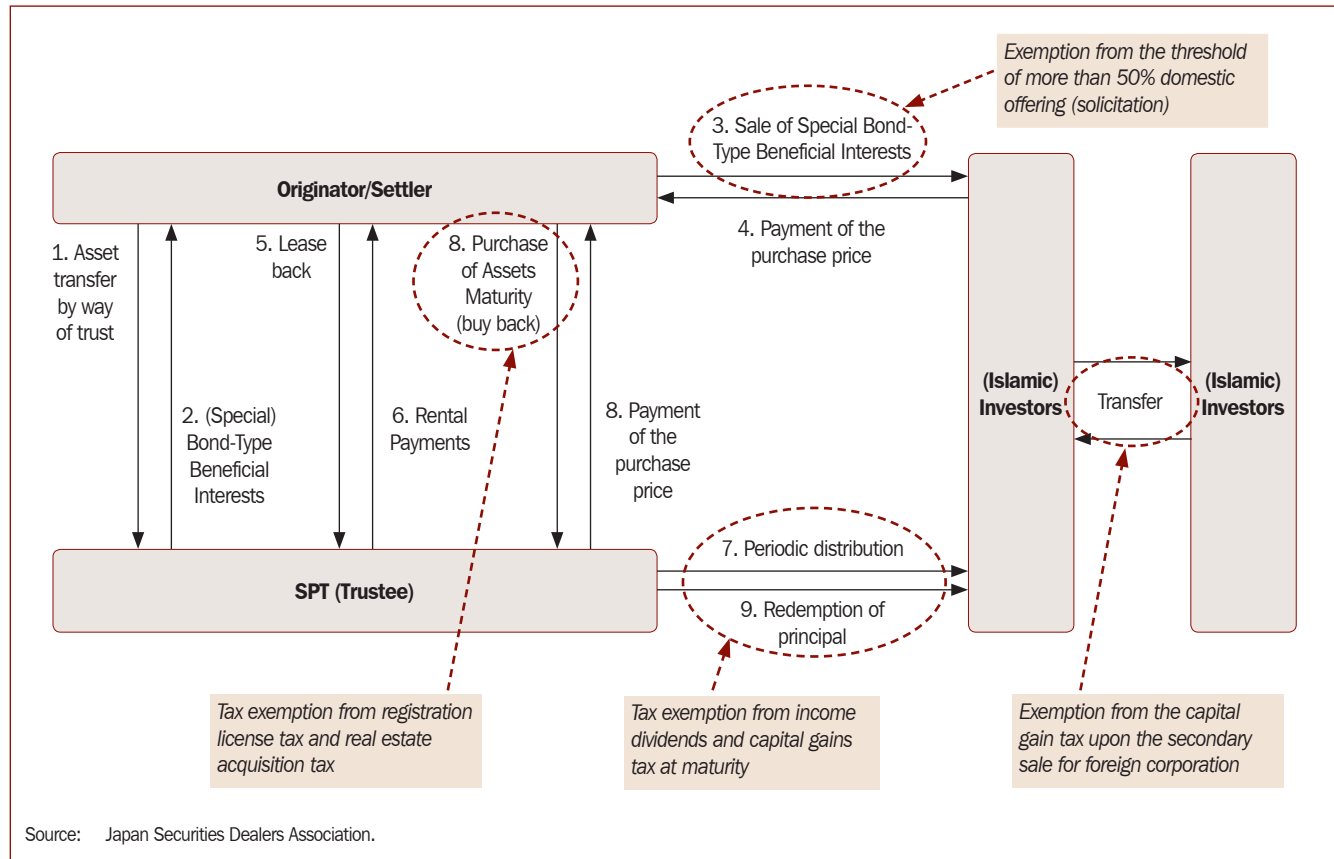

F. Impediments for Structuring Sukuk

1. The newly introduced Japanese Sukuk is a (Special) Bond-Type Beneficial Interests issued by SPT under the amended *Asset Securitization Act*, which is legally unique compared with the most commonly used type of trust certificates based on the Declaration of Trust. Thus, the usability of such vehicle is not well tested in the international context.
2. As this structure presupposes the Underlying Assets which actually exist and produce a stream of fixed cash-flows, it would be difficult to be used for the development-type real-estate leasing project where the Underlying Assets do not physically exist yet.
3. Relevant infrastructures such as settlement system, listing, implementation rules, accounting treatment, etc. should be developed concomitantly for facilitating the issuance of Japanese Sukuk.

In this regard, the TOKYO PRO-BOND Market, which was established by TOKYO AIM, a joint venture between the Tokyo Stock Exchange and the London Stock Exchange in

May 2011, decided to include the (Special) Bond-Type Beneficial Interests among its eligible bonds for listing and trading.

G. Significance of the Islamic Finance and Islamic Bonds (Sukuk) Market

Only one Shari'ah-compliant finance deal have been reported in Japan involving *tokumei kumiai*, a statutory category of partnership established by an agreement between a business operator and an investor who invests in a specified business of the operator, in the field of real-estate finance transaction. However, other types of Islamic financial transactions have not yet been achieved within Japan, including Islamic banking and Sukuk Issuance.

As mentioned above, several Japanese entities have issued Sukuks in overseas markets.

X. Next Step: Future Direction

A. Future Direction

1. Improvement of the Transparency of Bond Price Information

- a. Japan Securities Dealers Association (JSDA) manages the system of Reference Statistical Prices [Yields] for OTC Bond Transactions as an infrastructure of corporate bond price information. These reference prices are widely used by investors and market participants, and are indispensable infrastructure in the financial and securities markets.
- b. However, as the reference price sometimes diverges from the actual price (such as the execution price and the bid offer) and has a time lag, it is pointed out that it is necessary to review and improve the system.
- c. It is necessary to improve the transparency of corporate bond price information and build credibility for the information.

2. Enhancement of the Repo Market and Its Infrastructure

To vitalize the corporate bond secondary market, it is necessary to develop and enhance infrastructures such as a corporate bond repo market and a settlement/clearance system. Such efforts are believed to contribute to the expansion of the primary market.

Although the corporate bond repo market is expected to work as a financing and fund management tool for market participants and as means of avoiding fails, the need for repo transactions is not so large given the current corporate bond issuance size.

JSDA and market participants are engaged in discussions on how to enhance the securities settlement service functions in advance based on the corporate bond repo market and the lending functions in the U.S. and Europe in order to cope with the growth in issuance size and the expanding needs of corporate bond repo transactions in the future.

3. Enhancement of Functions of Settlement and Clearing Systems

A clearing house is indispensable to mitigate settlement risk, to improve the usability of investors and market participants, and to ensure liquidity. However, at the moment, as the issuance size and the transaction of corporate bonds are limited and, thus, the

netting effect of corporate bonds is not very large, JSDA and market participants have not yet established a settlement agency like the one for government bonds. Market participants need to hold discussions about the establishment of a clearing house for corporate bonds and other functional enhancements of a settlement and clearing system for corporate bonds in order to meet the growth of issuance size and the growing need for a clearing house.

B. Group of Thirty Compliance²⁴

The so-called G-30 Recommendations were originally conceived as the Group of Thirty's Standards on Securities Settlement Systems in 1989, detailing in a first of its kind report nine recommendations for efficient and effective securities markets and covering legal, structural and settlement process areas. The recommendations were subsequently reviewed and updated in 2001, under leadership of the Bank for International Settlements (BIS), and through the efforts of a Joint Task Force of the Committee On Payment and Settlement Systems (CPSS) and the Technical Committee of the International Organisation of Securities Commissions (IOSCO). Compliance with the G30 Recommendations in individual markets is often an integral part in securities industry participants' and intermediaries' due diligence process.

Table 10.1 Group of Thirty Compliance

Recommendation	Implemented
1 Eliminate paper and automate communication, data capture, and enrichment	Yes
2 Harmonize messaging standards and communication protocols	Yes
3 Develop and implement reference data standards	Yes
4 Synchronize timing between different clearing and settlement systems and associated payment and foreign exchange systems	Yes
5 Automate and standardize institutional trade matching	(Yes)
6 Expand the use of central counterparties	(Yes)
7 Permit securities lending and borrowing to expedite settlement	Yes
8 Automate and standardize asset servicing processes, including corporate actions, tax relief arrangements, and restrictions on foreign ownership	Yes
9 Ensure the financial integrity of providers of clearing and settlement services	Yes
10 Reinforce the risk management practices of users of clearing and settlement service providers	Yes
11 Ensure final, Simultaneous transfer and availability of assets	Yes
12 Ensure effective business continuity and disaster recovery planning	Yes
13 Address the possibility of failure of a systematically important institution	Yes
14 Strengthen assessment of the enforceability of contracts	Yes
15 Advance legal certainty over rights to securities, cash, or collateral	Yes
16 Recognize and support improved valuation methodologies and closeout netting arrangements	Yes
17 Ensure appointment of appropriately experienced and senior board members (of the boards of securities clearing and settlement infrastructure providers)	Yes
18 Promote fair access to securities clearing and settlement networks	Yes
19 Ensure equitable and effective attention to stakeholder interests	Yes
20 Encourage consistent regulation and oversight of securities clearing and settlement service providers	Yes

Source: Group of 30.

²⁴ Group of 30 (G30). 2003. *Global Clearing and Settlement – A Plan of Action*. <http://www.partad.ru/wrld/word/g30app1.pdf>; <http://www.group30.org/images/PDF/Global%20Clearing%20and%20Settlement%20Final%20Monitoring%20Report%202006.pdf>

C. Group of Experts Final Report: Summary of Market Barriers Assessment – Japan (April 2010)

The GoE Report refers to the published results in 2010 of the Group of Experts (GoE) formed under Task Force 4 of the Asian Bond Market Initiative (ABMI). In the report, published under the leadership of the Asian Development Bank (ADB), a group of securities market experts from the private and public sector in ASEAN+3, as well as International Experts, assessed the ASEAN+3 securities markets on potential market barriers, the costs for cross-border bond transactions, and the feasibility for the establishment of a Regional Settlement Intermediary (RSI). The findings in the GoE Report lead to the creation of ABMF.

Table 10.2 Summary of Market Barriers Assessment

Potential Barrier Area	Current Situation	Market Assessment Questionnaire Scores	Overall Barrier Assessment
Quotas	There are no market entrance requirements for foreign investors.	OK	OK
Investor registration	There are no registration requirements for foreign investors.	OK	OK
FX controls - conversion	The Japanese yen is freely convertible. There are no foreign exchange restrictions. Both third-party foreign exchange (FX) and offshore FX transactions are possible.	OK	OK
FX controls - repatriation of funds	As above. Sale proceeds or income from investments can be freely repatriated.	OK	OK
Cash controls - credit balances	Foreign investors can freely open cash accounts in Japanese yen. Credit balances are allowed.	OK	OK
Cash controls - overdrafts	There are no restrictions on overdrafts for non-residents.	OK	OK
Taxes	Tax generally works well. However, extensive documentation may be required for exemptions. In particular, gaining exemption for municipal bond issues is onerous. As a result, International Central Securities Depositories (ICSDs) do not currently provide a service for these bonds. The calculation of tax requires historical information in some exceptional cases.	LOW	LOW
Omnibus accounts	Omnibus accounts are permitted.	OK	OK
Settlement cycle	The settlement cycle is T+3.	OK	OK
Message formats	Japan Securities Depository Center, Inc. (JASDEC) (the central securities depository [CSD] for corporate bonds), and most local market participants, use SWIFT message formats. However, BOJ-Net (the CSD for government bonds) does not use SWIFT formats.	OK	OK
Securities numbering	ISIN codes are available for all local bond issues, and are available at the time of issue. JASDEC and most local market participants use ISIN. However, BOJ-Net does not use ISIN.	OK	OK
Matching	There are trade matching and pre-settlement matching systems for bonds.	OK	OK
Dematerialisation	Most corporate bonds and municipal bonds are held in Japan Securities Depository Centre (JASDEC) in dematerialized form. Some physical certificates still exist.	LOW	LOW
Regulatory framework	The regulatory regime is regarded as stable and consistent and no adverse comments were received in this area.	-	OK

BOJ-Net = Bank of Japan-Financial Network System; ISIN = International Securities Identification Number; SWIFT = Society for Worldwide Interbank Financial Telecommunication

Source: Asian Development Bank. [https://wpqr1.adb.org/LotusQuickr/asean3goe/Main.nsf/h_58E34A1388F9070B48257729000C0A4E90F408746827C16248257729000C1334/\\$file/Part3.pdf](https://wpqr1.adb.org/LotusQuickr/asean3goe/Main.nsf/h_58E34A1388F9070B48257729000C0A4E90F408746827C16248257729000C1334/$file/Part3.pdf)

XI. Examples of the Recommended Expression (RE) of Related Translations

1. Laws and Ordinances

- a. (RE) *Act on Special Measures Concerning Taxation* (Japanese law translation by Ministry of Justice) = 租税特別措置法 (*sozei tokubetsu sochihou*) (AE) *Special Taxation Measures Law*
- b. (RE) *Companies Act* (Japanese law translation by Ministry of Justice) = 会社法 (*kaishahou*) (AE) *Company Law*, (AE) *Corporations Act*, (AE) *Corporations Law*
- c. (RE) *Financial Instruments and Exchange Act* (Abbreviation: FIEA) (Japanese law translation by Ministry of Justice) = 金融商品取引法 (*kinyuu shouhin torihikihou*) (AE) *Financial Instruments and Exchange Act* (Abbreviation: FIEA)
- d. (RE) *Order for Enforcement* = 施行令 (*sekourei*)

Reference: Cabinet Order = 政令 (*seirei*),

Cabinet Office Ordinances = 内閣府令 (*naikakufurei*)

The Order for Enforcement of the Financial Instruments and Exchange Act = 金融商品取引法施行令

- e. (RE) *Cabinet Office Ordinance on Disclosure of [Corporate Information, etc./Information, etc. on Issuers of Foreign Government Bonds, etc./Information, etc. on Specified Securities]* = [企業内容/外国債/特定有価証券] 開示府令 (*kaiji furei*)²⁵
- f. (RE) *Cabinet Office Ordinance on Definitions under Art. 2 of the Financial Instruments and Exchange Act* = 定義府令 (*teigi furei*)²⁶
- g. (RE) *Cabinet Office Ordinance on Securities Information* = 証券情報の提供又は公表に関する内閣府令 (*naikakufurei*)

²⁵ From the Name of Laws and Regulations, Financial Services Agency (FSA) Japan http://www.fsa.go.jp/frtc/kenkyu/event/20070424_01.pdf

²⁶ From the Name of Laws and Regulations, Financial Services Agency (FSA) Japan http://www.fsa.go.jp/frtc/kenkyu/event/20070424_01.pdf

- h. (RE) *Cabinet Office Ordinance on Financial Instruments Business, etc.* = 業府令 (*gyoufurei*)²⁷
- i. (RE) *Law Concerning Book-Entry Transfer of Corporate Bonds, Stocks, and Other Securities* = 社債、株式等の振替に関する法律 (*shasai kabusiki tou no furikae ni kansuru houritsu*)

2. Disclosure Documents

- a. (RE) specified securities information = 特定証券情報 (*tokutei shouken jouhou*)
- b. (RE) Issuer filing information = 発行者情報 (*hakkoushajouhou*)
- c. Securities registration statement (SRS) = 有価証券届出書 (*yuukashouken todokedesho*)
- d. (RE) Annual securities report = 有価証券報告書 (*yuukashouken houkokusho*)
(AE) securities report
- e. (RE) Semiannual securities report = 半期報告書 (*hanki houkokusho*) (AE) semiannual report
- f. (RE) Quarterly securities report = 四半期報告書 (*shihanki houkokusho*) (AE) quarterly report
- g. (RE) Extraordinary report = 臨時報告書 (*rinji houkokusho*) (AE) current report
- h. (RE) Shelf registration statement = 発行登録書 (*hakkoutourokusho*)
- i. (RE) Supplement to shelf registration statement (Practical term) = 発行登録追補書類 (*hakkoutouroku tsuihoshorui*)²⁸
- j. (RE) securities notice = 有価証券通知書 (*yuukashouken tsuuchisho*)

3. Offering and Distribution

- a. (RE) public offering (Abbreviation: PO) = 募集 (*boshuu*)
(Japanese law translation by Ministry of Justice and FSA's official translation)

Under the FIEA, an offering which is subject to requirements to disclose the solicitation documents stipulated in the FIEA is called “public offering”, and an offering which is not subject to such requirements is called “private placement.” However, the expression does not always reflect the economic nature of the offering. For example, offering to specified investors is in a strict legal sense “private placement,” but is similar to “public offering” by its true nature. Issuers are required to submit specified securities information in place of securities registration statement (SRS).

- b. (RE) public offering of newly-issued securities = 新発債公募 (*shinpatsusai koubo*)

²⁷ Government of Japan. Financial Services Agency. <http://www.fsa.go.jp/en/news/2010/20100331-4/05.pdf>

²⁸ Footnote 34. <http://www.fsa.go.jp/en/news/2010/20100331-4/03.pdf>

Especially in the context that needs to distinguish between a public offering and a secondary distribution, this term is used.

- c. (RE) secondary distribution = 売出し (*uridashi*)
(Japanese law translation by Ministry of Justice and FSA's Official translation)

Especially in the context that does not need to distinguish between a public offering and a secondary distribution, "public offering" is sufficient for translation.

- d. (RE) Specified Investor = 特定投資家 (*tokutei touseika*)

This is the most frequently used expression in the practice of business in Japan. This expression is used in the FSA's public relations (PR) materials.²⁹
Alternative expression (AE) 1 = specific investor
This word was used in relatively old PR materials in the FSA.³⁰

Alternative expression (AE) 2 = professional investor
(Japanese law translation by Ministry of Justice and FSA's official translation)

- e. (RE) Private placement for specified investors = 特定投資家私募 (*tokutei touseika shibo*)

This word is legally correct because this is part of private placement in Japanese Law (FIEA).

- f. (RE) Offer to specified investors (Abbreviation: Offer to SI) = 特定投資家公募 (*tokutei touseika koubo*)

This word is a practical translation focusing on the reality that many investors can be subject to public offering.

- g. (RE) Offer of newly-issued securities to specified investors = 特定投資家(新発)公募 (*tokutei touseika shinpatsu koubo*)

If the primary market offering of the new issue is distinguished from the private placement of already-issued securities, the above expression will be used.

(AE) Primary offering to specified investors

- h. (RE) Offer to specified investors = 特定投資家私売出し (*tokutei touseika shiuridashi*)

(AE) Private placement for specified investors

²⁹ (AE) shelf registration supplement, Japanese law translation by the Ministry of Justice and FSA's Official translation.

³⁰ Footnote 35. <http://www.fsa.go.jp/en/newsletter/2009/01b.html>; <http://www.fsa.go.jp/sesc/english/aboutsesc/all.pdf>

- i. (RE) Offer of already-issued securities to specified investors = 特定投資家(既発)公募 (*tokutei tousika kihatsu koubo*)

(AE) Secondary offering to specified investors

Especially in the context that needs to distinguish between a private placement of newly issued securities and an offer of already-issued securities, this term is used.

- j. (RE) Securities for specified investors = 特定投資家向け有価証券 (*tokutei toushika muke yuukashouken*)

This expression is used in the SESC's PR materials while the expression "(AE) securities intended for specified investors" is used in the FSA's PR materials.³¹

- k. (RE) Private Placement for qualified institutional investors (QIIs) (Abbreviation: QII-PP) = 適格機関投資家私募 (*tekikaku kikan toushika shibo*)

- l. (RE) Private Placement of newly-issued securities for QIIs (AE) primary private placement for QIIs

- m. (RE) Private Placement for QIIs (Abbreviation: QII-PP) = 適格機関投資家私売出し (*tekikaku kikan toushika shiuridashi*)

- n. (RE) Private Placement of already-issued securities for QIIs (AE) secondary private placement for QIIs

- o. (RE) Private Placement for small number of people (Abbreviation: SN-PP) = 少数私募 (*shouninzuu shibo*)

- p. (RE) Private Placement of newly-issued securities for small number of people (AE) primary private placement for small number of people

- q. (RE) Private Placement for small number of people (Abbreviation: SN-PP) = 少数私売出し (*shouninzuu shiuridashi*)

- r. (RE) Private Placement of already-issued securities for small number of people (AE) secondary private placement for small number of people

4. Others

- a. (RE) Commissioned Company for bondholders (practical and understandable term) = 社債管理者 (*shasaikanrisha*)
(AE) bond manager (Japanese law translation by Ministry of Justice)
(AE) bond administrator (This word was used in relatively old materials in the era of the previous commercial code.)
- b. (RE) financial instruments business operator = 金融商品取引業者 (*kin-yuushouhin torihiki gyousha*)

³¹ Footnote 34. <http://www.fsa.go.jp/en/newsletter/2009/01b.html>; <http://www.fsa.go.jp/sesc/english/aboutsesc/all.pdf>

- c. (RE) registered financial institution = 登録金融機関 (*touroku kin-yuukikan*)
- d. (RE) financial instruments business operator, etc = 金融商品取引業者等 (*kin-yuushouhin torihiki gyousha tou*)
- e. (RE) Director-General of the Kanto Local Finance Bureau = 関東財務局長 (*kantouzaimukyokuchou*)
(AE) Director of the Kanto Local Finance Bureau (old expression)

References

- Ministry of Finance (MOF) Debt Management Report 2011
http://www.mof.go.jp/english/jgbs/publication/debt_management_report/2011/
- “Securities Market in Japan 2010” JSRI
<http://www.jsri.or.jp/web/publish/market/index.html>
- Japan Securities Dealers Association (JSDA)
<http://www.jsda.or.jp/en/index.html>
<http://www.jsda.or.jp/index.html>
- Tokyo Stock Exchange Group (TSE)
<http://www.tse.or.jp/english/index.html>
<http://www.tse.or.jp/>
- TOKYO AIM
<http://www.tokyo-aim.com/english/>
<http://www.tokyo-aim.com/japanese/>
- TOKYO PRO-BOND Market
http://www.tokyo-aim.com/probond_e/
<http://www.tokyo-aim.com/probond/>
- Japan Securities Depository Center Inc. (JASDEC)
<http://www.jasdec.com/en/>
<http://www.jasdec.com/>
- Financial Services Agency (FSA), The Japanese Government
<http://www.fsa.go.jp/en/index.html>
<http://www.fsa.go.jp/>

- AsianBondsOnline, Asian Development Bank
<http://asianbondsonline.adb.org/japan/structure/overview.php>
- “Grand Design for an Asian Inter-Regional Professional Securities Market (AIR-PSM)”
National Institute for Research Advancement of Japan
<http://www.nira.or.jp/pdf/airpsm.pdf>

Contact (ADB Consultant):

Prof. Shigehito Inukai
Faculty of Law, Waseda University
1-6-1, Nishiwaseda, Shinjuku-ku, Tokyo, 〒169-8050
Tel & Fax (Direct): + 81-(0)3-3202-2472
Mobile: +81-(0)80-3360-7551
E-Mail: shige.inukai@me.com

Republic of Korea Bond Market Guide

Contents

Acknowledgement	ix
I. Structure, Type, and Characteristics of the Bond Market.....	1
A. Classification and Descriptions of the Korea Bond Market	1
B. Descriptions of Public Offering and Private Placement Markets.....	4
C. Exchange Listed Market	4
D. Professional (Wholesale) Market and Retail Market	5
E. Definition of Professionals and Professional Investor.....	5
F. Methods of Issuing Bonds	5
G. Credit Rating Agencies and the Credit Rating of Bonds	9
H. Bond-Related Systems for Investor Protection	13
I. Listing of Bonds and Medium-Term Notes	18
J. Governing Laws on Bond Issuance.....	25
K. Related Legal and Regulatory Issues of the Market.....	25
L. Self-Governing Rules of the Market	26
II. Primary and Secondary Market-Related Regulatory Framework.....	27
A. Related Rules and Regulations on Issuing Debt Instruments	27
B. Regulations and Rules related to Buying Debt Instruments in the Secondary Market	30
C. Taxation Framework and Tax Requirements	40
III. Trading of Bonds and Trading Market Infrastructure.....	43
A. Over-the-Counter Trading of Bonds	43
B. Exchange Trading of Bonds	44
C. Bond Repurchase Market.....	50
D. FreeBond	61
E. Secondary Market Yields and Terms of Bond Issues.....	64
F. Transparency in Bond Pricing	65
G. Business Process Flowchart (Over-the-Counter Market/Delivery versus Payment).....	66
H. Business Process Flowchart (Exchange Market/Delivery versus Payment)	67
J. Short Sale of Bonds.....	76
K. Korea Treasury Bonds Exchange-Traded Funds Market.....	76
M. Bond-Related Futures Market: Korea Treasury Bonds Futures Market.....	78

IV. Possible Impediments for the Realization of a Cross-Border Market	82
A. Tax-Related Issues	82
B. Disclosure and Investor Protection Rules for Issuers	83
C. Restriction for Qualified Institutional Investors in Private Placement	87
D. Registration Requirement for Foreign Investors	88
E. Reporting Requirements for Non-Resident Trade Report and Foreign Exchange-Denominated Instruments	89
F. Non-Resident Requirements	89
G. Restrictions on Over-the-Counter Transactions by Non-Residents	89
H. Credit Rating System and Its Relation to Regulations.....	90
I. The Use of Omnibus Accounts for Settlement	90
J. Availability of Information in English	92
K. Restrictions in Accounting Standard	92
L. Limited Opportunities to Utilize Bond Holdings.....	93
M. Degree of Lack of Liquidity in the Secondary Market	93
V. Description of the Securities Settlement System.....	94
A. Existence of Uniform Legal Framework for All Types of Securities	94
B. Dematerialization or Immobilization versus Physical Securities	94
C. Legal Ownership Structure of Dematerialized or Immobilized Securities	94
D. Legal Ownership Transfer Mechanism	95
E. Existence of a Central Securities Depository and Book-Entry System for Debt Instruments.....	95
F. Settlement System in Korea.....	96
G. Existence of Delivery versus Payment and Real-Time Gross Settlement Mechanism	97
H. Existence of Post-Trade Matching Mechanism.....	98
I. Existence of Execution Matching Mechanism.....	98
J. Settlement Scheme for Corporate Bonds, Government Bonds and Others (Gross-Gross, Gross-Net, Net-Net)	99
K. Settlement Cycle for Corporate Bonds, Government Bonds and Other Debt Securities	99
L. Brief History of the Development of the Securities Settlement Infrastructure	100
M. Issues on Current Settlement Infrastructures	101
N. Expected changes on settlement infrastructures	101
VI. Costs and Charging Methods	103
A. Registration Fee at the Central Securities Depository	103
B. Transfer Fee (Book-Transfer Fee) at the Central Securities Depository.....	103
C. Average Ongoing Costs for Debt Instruments.....	103
D. Market Charges	104
VII. Market Size and Statistics	105
A. Bonds Issued.....	105
B. Outstanding Amount of Bonds Issued	106
C. Bond Trading Volume and Value (Over the Counter).....	106
D. Bond Trading Volume and Value (Exchange).....	107
E. Statistics of Over-the-Counter Institutional Repo Market	108
F. Size of Local Currency Bond Market in US Dollars.....	109
G. Size of LCY Bond Market in % of GDP.....	110
H. Size of FCY Bond Market in % of GDP (BIS)	112
I. Size of FCY Bond Market in USD (Local Sources)	113

J. Issuance Volume of LCY Bond Market in USD	114
K. Foreign Holdings in LCY Government Bonds	116
L. Trading Volume	117
M. Domestic Financing Profile	118
VIII. Next Step	119
A. Group of 30 Compliance	119
B. Group of Experts Final Report: Summary of Barriers Market Assessment – Korea (April/2010)	120
C. Revision of the <i>Commercial Act</i> and Corporate Bond Effective 2012	122
D. Commissioned Company System for Bondholders	124
E. Bankruptcy Procedures	125
Appendixes	127
References	133

Boxes, Figures, and Tables

Boxes

Box 1.1	Korea Financial Investment Association Rules on Securities Underwriting	8
Box 1.2	Financial Services Commission Regulation on Public Disclosure of Information on Over-the-Counter Trading	14
Box 1.3	Korea Financial Investment Association Regulation on Reporting on the Records of Over-the-Counter Trading	15
Box 1.4	Financial Services Commission Regulation on Reporting Quote Information	15
Box 1.5	Korea Financial Investment Association Regulation on Reporting on the Information on Quotation	16
Box 1.6	Korea Financial Investment Association Regulation on Disclosure of the Closing Quotes	17
Box 2.1	Definition of Foreign Corporation	36
Box 2.2	Scope of Foreign Corporation	36
Box 2.3	Definition of Foreign Nationals	36
Box 2.4	Definition of Omnibus Account Regarding Foreign Investment in Bonds	37
Box 2.5	Regulations Regarding Exemptions from Registration	37
Box 2.6	Regulations on Special Cases for Foreigner Investment Registration	38

Figures

Figure 1.1	Bond Listing System	19
Figure 2.1	Procedure for Applying for Foreign Investor Investment Registration Certificate through a Local Agent	40
Figure 2.2	Procedure for Applying for Foreign Investor Investment Registration Certificate in Person	40
Figure 3.1	Structure of the Bond Over-the-Counter Market	44
Figure 3.2	Repo Trading Mechanism	50
Figure 3.5	Operation of FreeBond	62
Figure 3.6	Process to List or Trade KTB ETF on the KRX	77
Figure 3.7	Separate Trading of Registered Interest and Principal of Securities	78

Tables

Table 1.1	Korean Credit Rating Agencies	9
Table 1.2	Bond Grades and Definitions	10
Table 1.3	Grade Hierarchy and Definition	11
Table 1.4	Korean Bond Pricing Agencies	12
Table 1.5	Initial Listing Criteria for Domestic and Foreign Bonds	18
Table 1.6	Listing Fees	23
Table 2.1	Minimum Net Asset Requirement for Investment Trading Business (W Billion)	32
Table 2.2	Minimum Net Asset Requirement for Investment Brokerage Business (W Billion).....	33
Table 2.3	Minimum Net Asset Requirement for Collective Investment, Trust, Investment Advisory, and Discretionary Investment Businesses (W Billion)	34
Table 2.4	Questions and Answers on Investment Registration Certificate and Documentation	35
Table 2.5	Official Documents that Authenticate the Lawful Identity of the Investor	39
Table 3.1	Proportion of Korea Exchange Bond Market (W trillion, %)	43
Table 3.2	Classification of Quotation Price, Quantity, and Trading Units.....	45
Table 3.3	Description of Settlement Process	46
Table 3.4	Trading Rules for Small-Lot Bond	47
Table 3.5	Bonds Eligible for Trading in the Special Market.....	47
Table 3.6	Requirements for Appointment as PPD	49
Table 3.7	Bonds Eligible for Trading at the Repo Market.....	51
Table 3.8	Settlement in the Repo Market.....	53
Table 3.9	Settlement at the REPO Market	55
Table 3.10	KRX Repo Trading System	55
Table 3.11	KRX Repo Settlement System.....	56
Table 3.12	Expiration of Repo	57
Table 3.13	Details of the Repo Trade Submitted by Repo Sellers or Brokerage Firms	59
Table 3.14	Questions and Answers on FreeBond and Over-the-Counter Trade Matching	64
Table 3.15	Secondary Market Yield and Terms of Bond Issues.....	64
Table 3.16	Types of Real-Time Bond Index	65
Table 3.17	Questions and Answers related to Market Infrastructure: InSet and SAFE	71
Table 3.18	Questions and Answers related to Clearing/Securities Settlement (Answered by KSD)	75
Table 3.19	Listed Korea Treasury Bond Exchange-Traded Funds.....	77
Table 3.20	Korea Treasury Bond Exchange-Traded Funds Trading System.....	77
Table 3.21	Korea Treasury Bonds Futures Trading System	79
Table 3.22	3-Year Korea Treasury Bonds Futures	79
Table 3.23	Underlying Basket Bonds for 3-Year Korea Treasury Bonds Futures.....	79
Table 3.24	Specification of 5-Year Korea Treasury Bonds Futures.....	80
Table 3.25	Underlying Basket Bonds for 5-Year Korea Treasury Bonds Futures.....	80
Table 3.26	Specification of 10-Year Korea Treasury Bonds Futures.....	81
Table 3.27	Underlying Basket Bonds for 10-Year Korea Treasury Bonds Futures.....	81
Table 4.1	Overview of Credit Rating Framework and Governing Regulations	90
Table 5.1	Brief History of the Development of the Securities Settlement Infrastructure.....	100
Table 5.2	Korea Securities Market Settlement System.....	101
Table 5.3	Main Contents of the New Securities Settlement System.....	101
Table 6.1	Fee Rates by Classification of Bond.....	103
Table 6.2	Maintenance Fee (Deposit Fee) at the Central Securities Depository (monthly basis)	103
Table 6.3	Brokerage Commission	104
Table 7.1	Bonds Issued (W billion).....	105
Table 7.2	Outstanding Amount of Bonds Issued (W billion).....	106

Table 7.3	Bonds Issued (W100 million).....	106
Table 7.4	Bond Trading Volume and Value Exchange (W100 million)	107
Table 7.5	Trading Value and Balance (W100 million)	108
Table 7.6	Trading Volume of the Purchased Securities (W 100 million).....	108
Table 7.7	Size of LCY Bond Market in USD (Local Sources) (\$ billion)	109
Table 7.8	Size of LCY Bond Market in % GDP (Local Sources) (% GDP, \$ billion).....	110
Table 7.9	FCY Bonds to GDP Ratio (\$ billion).....	112
Table 7.10	FCY Bonds Outstanding (Local Sources) (\$ billion)	113
Table 7.11	Issuance Volume of LCY Bond Market in USD (\$ billion)	114
Table 7.12	Foreign Holdings in LCY Government Bonds (W billion)	116
Table 7.13	Trading Volume (\$ billion).....	117
Table 7.14	Domestic Financing Profile (\$ billion).....	118
Table 8.1	Global Clearing and Settlement – A Plan of Action	119
Table 8.2	Summary of Barriers Market Assessment – Korea (April 2010).....	120
Table 8.3	Question and Answer related to the New Commercial Act Scripless Provisions (Answered by KSD).....	124

Acknowledgement

The Asian Development Bank (ADB) Team, comprising Satoru Yamadera (Economist, ADB Office of Regional Economic Integration, - September 2011), Seung Jae Lee (Principal Financial Sector Specialist), Shinji Kawai (Senior Financial Sector Specialist [Banking]), Shigehito Inukai (ADB consultant), Taiji Inui (ADB consultant), and Matthias Schmidt (ADB consultant), would like to express their sincere gratitude to national member and expert institutions Korea Financial Investment Association (KOFIA), Korea Exchange (KRX), Korea Securities Depository (KSD) and Korea Capital Market Institute (KCMI). They kindly provided answers to the questionnaires prepared by the ADB team, thoroughly reviewed the draft of the Market Guide, and gave their valuable comments.

It is also noteworthy to mention that the creation of the so-called ASEAN+3 Bond Market Forum-Korea (ABMF-K) group comprising of the abovementioned members, experts, and other volunteer supporters is a major achievement (as market associations go, it is an excellent suggestion for other markets) and the effort undertaken and the commitment given by the group was substantial.

The ADB team also would like to express special thanks to Citibank, Deutsche Bank AG, HongKong Shanghai Banking Corporation (HSBC), J.P. Morgan, and State Street for their contribution as international experts in providing information from their respective market guides, as well as their valuable expertise. Because of their cooperation and contribution, the ADB Team started the research on solid ground.

Last but not least, the Team would like to thank all the interviewees who gave their comments and responses to questions during the market consultations.

It should be noted that any part of this report does not represent official views and opinions of any institution which participated in this activity as ABMF members and experts. The ADB Team bears responsibility for the contents of this report.

February 2012

Asian Development Bank (ADB) Team

List of Interviewees:

Seoul, 27 June 2011

- Korea Exchange (KRX)
- Korea Capital Market Institute (KCMI)
- Korea Financial Investment Association (KOFIA)
- Financial Supervisory Service (FSS)
- Korea Securities Depository (KSD)

Seoul, 28 June 2011

- SC First Bank
- Citibank Korea
- Lee & Ko (Law Firm)
- Bank of Korea

Seoul, 29 June 2011

- HSBC
- J.P. Morgan Chase

I. Structure, Type, and Characteristics of the Bond Market

A. Classification and Descriptions of the Korea Bond Market

1. Classification of Bonds

Publicly offered bonds are classified by type of issuer into the following:

- i. Government bond,
- ii. Municipal bond,
- iii. Special bonds including monetary stabilization bond (MSB), bank bonds, and other financial bonds,
- iv. Corporate bonds, and
- v. Asset-backed securities (ABS).

2. Description of Bonds

a. Government Bonds

The first government bonds in the Republic of Korea were the nation-building government bonds in 1949. Since then, a wide variety of government bonds have been issued and integrated into Korea Treasury bonds (KTB) since the “Bonds on Fund for Management of Government Bonds” were issued in 1994.

Currently, government bonds issued include KTB, National Housing Bond (NHB) Type 1 and 2, and Foreign Exchange Equalization Fund Bonds (FEEFB), which are denominated in foreign currency. Among these, KTB are issued in the largest volume and trading is active. Accordingly, the on-the-run KTB market yields serve as a benchmark yield.

There are currently four types of KTB issued by maturity—3-year, 5-year, and 20-year—depending on the rate of interest. These fall into fixed-interest type bonds (3-year, 5-year, 10-year, and 20-year) and inflation-linked KTB (10-year maturity). Inflation-linked KTB links the principal and coupon rate of the KTB to prices, thereby eliminating inflation risk that comes with investing in KTB, thus ensuring the purchasing power parity of the bonds.

b. Municipal Bonds

Municipal bonds are issued by local governments, which comprise industrial development bonds and subway construction bonds.

c. Special Bonds

Special bonds consist of MSB issued by Bank of Korea, bank bonds issued by commercial banks, and other financial bonds issued by financial institutions excluding commercial banks.

d. Corporate Bonds**i. Issuance of Corporate Bonds**

Corporate bonds issuances are divided into direct issuances and indirect issuances depending on who issues the bonds.

(1) Direct issuance

- (2) Indirect issuance.** Indirect issuance comprises of firm commitment, stand-by agreements, and a best-effort-basis depending on who handles the risk related to the underwriting. In addition, bonds comprise of par value, discount issue, and issues at a premium.

ii. Types of Corporate Bonds

Corporate bonds can be categorized into bonds with guarantees or collateral, ways of paying interest, and the rights given to holders of corporate bonds.

- (1) Bonds with Guarantees or Collateral.** Bonds with guarantees or collateral can be classified further into guaranteed bonds, collateral bonds, and non-guaranteed bonds.

(a) Guaranteed Bonds

Guaranteed bonds refer to corporate bonds where a financial institution guarantees the redemption of the principal and interest. Guarantees of the principal and interest payments are provided by banks, Korea Credit Guarantee Fund, Korea Technology Finance Corporation, merchant banks, financial investment companies, and surety insurance companies. The issuing company pays a guarantee fee to the guaranteeing company.

(b) Collateral Bonds

Collateral bonds are secured by physically guaranteeing redemption of the principal and payment of interest. They are issued in accordance with the *Secured Bond Trust Act*.

(c) Non-guaranteed Bonds

Non-guaranteed bonds are issued by the issuer's credit without the guarantee or collateral provided by a financial institution for principal redemption. Most Korean corporate bonds are issued as debentures.

The underwriters of the bonds are required to undergo credit assessment of the debentures from two or more different credit rating agencies.

(2) Bonds Categorized by Interest Payment

Bonds categorized by their interest payment are coupon bonds, discount bonds, and compound bonds.

Coupon bonds refer to corporate bonds with coupons denoting the payment of interest at a regular schedule.

Discount bonds are corporate bonds where the principal and interest rate are the par value, and the interest is discounted in the lump sum.

Compound bonds involve the computation of compound interest for the interest cycle. Thereafter, the principal and interest are paid in a lump sum on the date of maturity.

(3) **Bonds Categorized by Redemption Period**

Depending on the redemption periods, bonds can be divided into short-term bonds, medium-term bonds, and long-term bonds. Generally, short-term bonds have redemption periods under 1 year; medium-term bonds, between 1 year and 5 years; and long-term bonds, over 5 years. Of note, long-term bonds refer to bonds that mature in 10 or 20 years in the United States of America.

(4) **Bonds Categorized by Method of Interest Payment**

In addition, there are fixed-income bonds and floating rate notes (FRN) depending on how interest is paid. Fixed-income bonds involve the payment of fixed periodic returns, and FRN has a variable interest rate that is linked to the benchmark interest rate.

(5) **Bonds categorized by Bondholder**

Bonds categorized by the holder of bonds are convertible bonds, bonds with warrant, exchangeable bonds, participating bonds, and bonds with embedded option.

Convertible bonds (CB) can be converted to the issuing company's equity on certain conditions. Meanwhile, bonds with warrants entitle the holder to purchase a certain quantity of any future issue of the company's stocks at a fixed price after a set period of time has passed.

Exchangeable bonds permit the holders to exchange their bond holding for the listed shares of a company under previously agreed conditions within a set timeframe. Participating bonds entitle the holder to receive dividends.

Bonds with embedded options allow the issuer to redeem all or part of the bond before it reaches its maturity date. The options include call options where the issuer can redeem the principal and interest before maturity and put options, which allows the holder of the bond the right to demand the issuer to repay the principal on the bond.

e. Asset-Backed Securities

An ABS is a security issued based on underlying assets originating from corporations or financial institutions. By standardizing and pooling the financial assets from originators in specific terms, such assets are securitized utilizing the cash flows of underlying assets and credit enhancement. The ABS then channels the principal and interest to the concerned parties.

B. Descriptions of Public Offering and Private Placement Markets

1. Public offering

Public offerings generally refer to actions with the aim of selling to multiple ordinary investors. The *Financial Investment Service and Capital Market Act* (FSCMA) defines public offering as public offering and public sale.

The term “public sale” in the Act refers to gathering 50 or more investors, as calculated by a formula prescribed by presidential decree and Financial Services Commission (FSC) regulation on issuance, public disclosure, etc. of securities, to make an offer to sell or invite offers to purchase securities already issued (see FSCMA Art. 9. 9 in Appendix 1).

In other words, this means soliciting 50 or more investors (the sum of those who have received recommendations) that have not made, applied to, or bought the same type of securities as the securities being offered within 6 months from the day offers to buy are made. As such, the FSCMA refers to recommendations for application for public offering and sale to the public during the previous 6 months. Here, “public” refers to parties that are subject to the offers and sale, consisting of 50 or more investors.

2. Private Placement

Private placement refers to a private offering of securities for new issuance to investors. It entails that the issuer issues securities directly to certain demand-side parties to raise capital from them. This means that the bond certificate is only issued to the subscriber, or has undergone third-party underwriting. It is referred to as private placement since it is not intended for the public.¹

An official definition of “private placement” can be found in Art. 9, *Financial Investment Service and Capital Market Act* (see Appendix 1.1).

C. Exchange Listed Market

The Korean bond exchange market is comprised of the inter-dealer market (IDM) and the retail market. Between these markets, primary dealers mainly participate in the IDM.

Before the Asian financial crisis in the late 1990s, the Korean bond market comprised mostly corporate bonds. In 1998, during the financial crisis, the International Monetary Fund (IMF) bailout prompted the Korean government to announce the “Measure to Improve Government Bond Policies and Vitalize the Bond Market.” As part of the process to facilitate development of the government bond market, primary dealers (PDs) were introduced in 1999, and the IDM was opened in the Korea Exchange (KRX). Participants in the IDM are limited to financial investment firms and banks. The bid-and-ask order details presented by each dealer are collected and disclosed on the system, and transactions are made among dealers. The tick size is W1 and uses the limit-order method. The order quantity is a whole number multiple of W1 billion. The market is open from 9:00 a.m. to 3:00 p.m., and transactions are

¹ Korea Financial Investment Association, 2010 *Capital Market in Korea*. Korea Financial Investment Association, p.117–118.

made through individual competitive bidding using multiple prices depending on the priority of best quotation and time principle from the presented bid-ask price. Settlement generally takes place through Bank of Korea (BOK)-Wire and the bonds are transferred through escrow accounts at the Korea Securities Depository (KSD). It is thus similar with, yet slightly different from the over-the-counter (OTC) market-delivery versus payment (DVP) method. In other words, the OTC-DVP method settles the total amount for each transaction, while in the exchange market, the funds are settled depending on the participant, and bonds are subtracted depending on the participant and bond issues. The settlement date is T+1.

In the ordinary bond market, transactions generally involve retail bonds, small-cap government and public bonds, and equity-linked corporate bonds, with ordinary investors being the main participants. Retail and small-cap bonds are traded in units of W1,000, while equity-related corporate bonds and ordinary bonds are traded in units of W100,000. Transactions are concluded through individual competitive bidding through four types of competitive bidding principles, depending on the priority of price, time, brokerage, and quantity.

D. Professional (Wholesale) Market and Retail Market

Discussion on the professional (wholesale) market is currently under “Qualified Institutional Buyer (QIB) market.”

E. Definition of Professionals and Professional Investor

The FSCMA classifies an ordinary investor and a professional investor based on their professional knowledge and experience, as well as the amount of assets. A professional investor refers to an investor who does not need any strong investor protection measures considering its own expertise and experience, such as a nation, a local municipality, a central bank, and a financial institution. Most individual investors fall under the classification of an ordinary investor with the exception of an investor whose financial investments exceeds W5 billion. Such classification aims to protect ordinary investors from taking huge risks in making investments due to the lack of such understanding of the financial investment instruments.²

F. Methods of Issuing Bonds

1. Government Bonds (Korean Treasury Bonds)

The procedure for issuing KTBs is enumerated below:³

a. Establish Plans to Issue Korean Treasury Bonds

The Ministry of Strategy and Finance should discuss with relevant agencies any plans to issue KTBs and the issue is subject to deliberation by the National Assembly. A detailed issuing plan should also be established within the annual KTB issuance limit approved by the legislature. An announcement of issuing plans and bidding should

² Footnote 1, p. 297.

³ Footnote 1, p. 125.

then be released. The Minister of Strategy and Finance announces annual/monthly plans for each year. In principle, the date and time of bidding the issuing amount, coupon rate and settlement will be disclosed up to 3 days prior to the commencement of bidding.

b. Bidding

The bidding date for KTBs is as follows:

- i. 3-year KTB: Every first Monday
- ii. 5-year KTB: Every second Monday
- iii. 10-year KTB: Every third Monday (Wednesday for inflation-linked KTB)
- iv. 20-year KTB: Every fourth Monday

Bidding time are scheduled from 10:40 a.m. to 11:00 a.m. Bidding is done through the BOK-Wire, a network operated by the BOK. The bid interest rates are grouped in intervals of 3 basis points (bp) from the highest successful bid downwards within the range of amount to be issued. The highest successful bid's interest rate in each group is applied. Participants in the bidding are:

- i. Only KTB primary dealers are eligible to participate in KTB auctions.
- ii. Non-primary dealer bidders may bid through KTB primary dealers who act as proxy agents.
- iii. However, if a retail investor bids through a primary dealer, the bid security deposit and written bid should be submitted in advance.

c. Announcement of Bidding and Results

The Minister of Strategy and Finance announces the details of bidding and the accepted bids when they are complete.

d. Issuance of Korean Treasury Bonds and Settlement of Successful Bids

The issuance of KTB and payment of the successful amount are done after the bidding date. On the day of settlement, the KSD is notified by BOK-Wire immediately after the underwritten amount is remitted, and the settlement and issuance are completed. All KTB types are registered, issued and deposited at the KSD. Accordingly, transaction and exercise of rights are possible without issuance of physical bond certificates.

2. Corporate Bonds

The procedure for issuing corporate bonds is enumerated below:⁴

a. Company Registration

An entity seeking to issue corporate bonds must register with the FSC for public issue of non-guaranteed bonds.

b. Acquire Credit Rating

The company, after registration with FSC, must submit itself for credit assessment. The evaluation will require a period of 2 to 4 weeks. A credit rating from two or more credit rating agencies is also required.

⁴ Footnote 3.

c. Decision by Board of Directors

Issues related to issuing corporate bonds are decided through a resolution by the company's board of directors, which indicates the issuing amount, issuing interest rate, managing company, and other relevant information.

d. Sign to Pay Principal and Interest as Agent

The company must decide where to pay corporate bond and which institution will pay the principal and interest after the corporate bond is issued as indicated by its agent in the application form and bond certificate.

e. Select Manager and Trustee

The company will then select a managing company that will underwrite and manage the corporate bonds, and a trustee that will take the necessary measures to protect the bond holders from the period of time involving payment for bonds to principal repayment.

f. Due Diligence

The lead manager then checks for risk factors through due diligence of companies.

g. Submit Securities Report

The company subsequently Submit securities report and attached documents (subscription agreement, trustee agreement, principal and interest payment agency agreement, etc.) to the Korea Financial Investment Association (KOFIA).

h. Effectivity

Unsecured corporate bonds take effect 7 days after the registration statement submission. Secured bonds, collateral bonds, and ABS take effect 5 days after the registration statement has been submitted. Shelf registration for corporate bonds is 5 days after registration statement submission.

i. Submit Prospectus

When the bond takes effect after the submission of the registration statement, the issuer distributes and discloses the prospectus to its branches, KOFIA, and firms that will accept applications.

j. Issuance and Payment

Issuance, payment and listing take place simultaneously.

k. Issuance Reporting

After issuance is complete, an issuance report is submitted to the Financial Supervisory Service (FSS).

l. Report Underwriting by Managers

Managers must report underwriting performance to KOFIA 5 days from issuance day. Regulations on securities underwriting is detailed in Chapter 3 of KOFIA Rule (Box 1.1).

Box 1.1 Korea Financial Investment Association Rules on Securities Underwriting

KOFIA Rule 3. REGULATIONS ON SECURITIES UNDERWRITING BUSINESS	
CHAPTER III UNDERWRITING OF NON-GUARANTEED BONDS	
Article 11. (Underwriting of Non-Guaranteed Bonds)	<p>(1) In the case of an underwriter underwriting non-guaranteed bonds, such bonds shall be those that have been rated by at least two (one agency, in the case of underwriting ABS issued in the form of bonds pursuant to the Act on ABS or in inevitable cases such as the business suspension of credit rating agencies) credit rating agencies from among those approved for the credit ratings business pursuant to the provisions of the Act on Use and Protection of Credit Information. However, non-guaranteed bonds issued by foreign corporations, etc., shall be deemed as those rated in accordance with this provision if they are rated by two or more credit rating agencies (referring to international credit rating agencies as prescribed by the Governor of the Financial Services Commission in Item e of [Article 2-11(2)1] of the FSC's Regulations on Securities Issuance and Disclosure; the same hereinafter in this chapter). [Amended on 26 February 2009]</p> <p>(2) In the case of underwriting non-guaranteed bonds, the issuer of non-guaranteed bonds and the trustee for the subscription of such bonds (hereinafter referred to as "trustee") shall enter into a standard trustee agreement on non-guaranteed bonds (hereinafter referred to as "standard trustee agreement"). However, this provision shall not apply to non-guaranteed bonds falling under any of the following Items:</p> <ol style="list-style-type: none"> 1. Bonds issued by credit-specialized financial companies under the Credit-Specialized Financial Business Act; 2. Bonds issued by merchant banking corporations; 3. Bonds issued by banking institutions under the Banking Act; 4. Bonds issued by financial investment companies; 5. ABS issued in the form of bonds pursuant to the Act on ABS; 6. ABS issued in the form of bonds pursuant to the Act on Mortgage Backed Bonds Companies; and 7. Bonds announced by the Association, among those issued by corporations subject to other special acts. <p>(3) Notwithstanding Paragraph (2), in the case of underwriting non-guaranteed bonds issued by foreign corporations etc., a trustee agreement modified from the standard trustee agreement may be used upon the Association's approval.</p> <p>(4) The standard trustee agreement on non-guaranteed bonds mentioned in Paragraph (2) shall be determined by the Association.</p> <p>(5) The issuer and trustee of non-guaranteed bonds shall not have a relationship falling under any Item of [Article 6(1)]. However, this provision shall not apply to non-guaranteed bonds issued by the Korea Exchange and other securities financial companies.</p>
Article 12. (Determination of Issuing Conditions of Non-Guaranteed Bonds)	The lead manager shall, in relation to the underwriting of non-guaranteed bonds, determine the issuing conditions, such as the coupon rate, upon consultation with the issuer.
Article 13. (Restrictions on the Managing Underwriter of Non-Guaranteed Bonds)	<p>(1) A financial investment company in any of the following relationships with the issuer shall not be allowed to engage in the business of managing underwriter for non-guaranteed bonds of the financial investment company concerned. However, this provision shall not apply to non-guaranteed bonds issued by the Korea Exchange and securities financial companies:</p> <ol style="list-style-type: none"> 3. Relationships where an issuer or a related party of the issuer holds 5/100 or more of a managing underwriter's stocks, etc.; 4. A managing underwriter or a related party of the managing underwriter holds 5/100 or more of the issuer's stocks; and 5. Relationships falling under any Items of [Article 6 (1) 4 through 6]. <p>(2) The lead manager of non-guaranteed bonds shall not, if the underwriter and issuer have a relationship as defined in [Article 6 (1)1], allow the underwriter concerned to underwrite the largest portion of stocks, or to engage in practical managing affairs such as participation in determining the underwriting price; provided, however, that this provision shall not apply to non-guaranteed bonds issued by the Korea Exchange and securities financial companies.</p>

continued on next page

Box 1.1 continuation

Article 14. (Underwriting of Won-Denominated Bonds)	A financial investment company shall underwrite won-denominated bonds that satisfy the requirements of any of the following items: <ol style="list-style-type: none"> 1. Won-denominated non-guaranteed bonds shall receive a rating from two or more (one in unavoidable case such as the agency's suspension of business) credit rating agencies. [Amended on 26 February 2009]; and 2. Won-denominated bonds shall be registered and issued pursuant to [Article 309 (5)] of the Act (excluding the bonds sold overseas).
Article 18. (Disclosure of Business Records of a Managing Underwriter of Bonds)	(1) The managing underwriter (including a broker for offering and private placement) for bond issuance (including the privately-placed bond issues) shall prepare and report to the Association the matters related to an issuer, in accordance with <Annexed Paper 3: Forms>, within five (5) days from the date of issuance. However, in the case of jointly engaging in the managing affairs, the managing underwriter that prepares the securities registration statement shall report to the Association. [Amended on 26 February 2009] (2) The Association may post the information that it was notified of by the managing underwriter pursuant to Paragraph (1) on its Internet website.

Source: Korea Financial Investment Association. 23/12/2009. Regulations on Securities Underwriting Business.

G. Credit Rating Agencies and the Credit Rating of Bonds

1. Private Credit Rating Agencies for Bonds

There are four credit rating companies in Korea—Korea Ratings, KIS Pricing, NICE Pricing Services, and SCI Pricing. Table 1.1 provides a general overview of Korean credit rating agencies.

Table 1.1 Korean Credit Rating Agencies^a

	Korea Ratings	KIS	NICE	SCI
Capital	W34.05 billion	W5 billion	W5 billion	W17.75 billion
No. of employees	170	109	121	217
Web site	www.korearatings.com	www.kisrating.com	www.nicerating.com	www.sci.co.kr
M/S (%) ^b	34.3	33.4	31.6	0.6
Largest shareholder	Fitch (73.55%)	Moody's (50%+1 share), KIS (50%-1)	NICE (100%)	SP Partners (19.19%)
Initiation of operations	November 1987	September 1985	June 1987	Established April 1992 Began credit assessment from January 2000
Bonds for evaluation	Corporate bonds, CP, ABS	Corporate bonds, CP, ABS	Corporate bonds, CP, ABS	CP, ABS
Partner companies in credit assessment	Fitch	Moody's	Japan R&I, China Dagong Rating	Japan JCR

^a As of June 2009.

^b Market share source was generated from the Financial Supervisory Service press release.

ABS = asset-backed securities; CP = commercial paper

Sources: Press Release 279 of the financial Supervisory Service, 13 March 2009; Credit Information Services Providers' Operating results; 2008

2. Credit Rating Assessment

a. Corporate Bond Assessment

When a company issues corporate bonds to raise long-term capital for over 1 year from the direct financing market, they are required to obtain a credit rating from a specialized credit rating agency for all non-guaranteed bonds to protect small-cap investors who lack professional knowledge on the issuer, and to induce a reasonable price in the bond market.

All non-guaranteed corporate bonds, excluding government bonds and bonds for which the government has guaranteed the payment of principal and interest as well as municipal bonds and MSBs issued by BOK, must receive a credit rating to be included in the trusted assets of banks and investment trust companies. In other words, bonds being issued without guarantee, including those by ordinary companies, specialized lenders, financial investment firms, commercial banks, the Korea Development Bank, government-funded agencies and pension funds, must first receive a credit assessment from a specialized credit rating agency. Corporate bonds' credit ratings are used as criteria for deciding upon investment when issuing and trading non-guaranteed bonds. It is also used as criteria for the mark-to-market value of funds that are subject to mark-to-market.

Bonds are rated in 10 grades depending on how much of the principal and interest is payable, from AAA to D. AAA to BBB are investment grade where the principal and interest are deemed to be recoverable, while BB to C are classified as speculative grade as they are heavily influenced by change in the investment environment.

Table 1.2 Bond Grades and Definitions

Grade	Definition
AAA	Highest ability to repay principal and interest
AA	Excellent ability to repay principal and interest but slightly less than AAA-rated bonds
A	Very good ability to repay principal and interest but vulnerable to economic conditions and environment
BBB	Good ability to repay principal and interest but possibility exists of economic conditions and environment deterioration lowering its ability to repay principal and interest going forward
BB	Although its ability to repay principal and interest is not immediately problematic, the bonds have speculative factors since stability to go forward is not guaranteed
B	Ability to repay principal and interest is lacking; is speculative; in recession repayment of interest is not certain
CCC	Uncertainties currently exist in its ability to repay principal and interest. Highly speculative given the high risk of default.
CC	Higher uncertainty factors exist compared with the upper grades.
C	High risk of default; lacks ability to repay principal and interest
D	Unable to repay
Note: Among the above grades, AA to B are marked with the signs + or - to denote the superior or inferior recoverability of principal and interest. Source: Korea Investors Service.	

b. Commercial Paper Assessment

Issuance condition and the decision to invest are determined by the credit rating of the issuers of commercial paper (CP), which is issued to raise short-term operating funds.

Accordingly, the government has objective credit rating agencies grade the credit of issuing companies and disclose the results to develop the commercial-note market into one where blue-chip companies may raise short-term capital. This assessment is used to protect investors and enable financial institutions to serve as brokerages, and ensure financial soundness of management.

Companies that seek to obtain short-term financing by issuing unsecured debentures or notes to borrow and lend money among customers with merchant banks, brokerage houses, and banks acting as intermediaries are required to undergo credit assessments for their commercial paper.

Credit rating grades for commercial paper are used to determine the soundness of the commercial paper (unsecured commercial paper and merchant bank intermediary notes) issuance and are used as criteria for deciding terms and conditions of issuance. Credit ratings for commercial paper comprise six grades from A1 to D. Among the grades, A1 to A3 are investment grades where the issuers have been acknowledged to have the ability to repay principal and interest in a timely manner; B and C are speculative grades where the repayment of principal and interest on time is heavily influenced by changes in the environment.

Table 1.3 Grade Hierarchy and Definition

Grade	Definition
A1	Best ability to repay on time and best stability of repayment ability
A2	Very good ability to repay on time but stability slightly inferior to A1
A3	Good ability to repay on time with good stability but inferior to A2
B	Adequate ability to repay on time but speculative issues exist on its stability depending on short-term changes in conditions
C	Highly speculative issues in ability to repay on time and in its stability
D	Cannot repay

Note: Among the above grades, A2 to B grades are marked with + or – to denote the superior or inferior ability to repay principal and interest.
Source: Korea Investors Service

c. Asset-backed Securities Assessment

Asset-backed securities (ABS) are given credit rating grades the same way as non-guaranteed corporate bonds or commercial paper, depending on the type (ABS and Asset Backed Commercial Paper). The credit rating system and definitions are made the same as the system and definition of non-guaranteed corporate bonds and commercial paper, thereby easing decisions on the issuer's ability to repay principal and interest on the ABS.

3. Mark-to-Market of Bonds

a. Summary

In November 1998, after the Asian financial crisis, the government introduced the mark-to-market policy to enhance transparency of trusted asset management, secure confidence, and raise the asset quality of financial institutions. Before the mark-to-market system was introduced, bonds were evaluated on book value. This latter method prompted questions on its accuracy, given that it derived a mathematical

average of the principal and interest during the time it was held, regardless of any changes in the value of the bonds due to interest changes in the market. This resulted in a difference between the market price and book value and became problematic when it was sold before maturity or if a company went bankrupt.

Mark-to-market aligns market value and valuation by assessing the value of a bond by reflecting changes in the interest and credit of the issuer. Bond prices change depending on the market interest rate, akin to daily fluctuations in the price of equity. Mark-to-market refers to evaluating this changing bond price and using the market or fair price. To this end, KOFIA announced the “mark-to-market base yield” in November 1998 to enhance the mark-to-market system.

After valuations by bond rating agencies became mandatory in 2004, KOFIA halted its mark-to-market and changed its mark-to-market base yield to types of bonds, yield to maturity (YTM), and market yield, which is a type of reference yield that KOFIA discloses. From November 2009, the yield-reporting companies for deriving yield by bond type, YTM, and market yields changed from financial investment firms to credit assessment companies. In addition, KOFIA has also been monitoring the valuation price of each credit rating agency according to its sampling standards aiming to evaluate each bond rating agency as per the *Regulations on the Operations and Business of a Financial Investment Company*. KOFIA monitors approximately 10,000 issues per month by various rating agencies. The results are reported to each company and to the FSS. These results are posted at KOFIA Bond Information Service (www.kofiabond.or.kr) each quarter.

b. Private Credit Rating Agencies for Bonds Established

In July 2000, the FSS designated three companies—Korean Bond Pricing Co., Ltd., NICE Pricing Services, and KIS Pricing—to implement the mark-to-market policy by providing the market value of all bonds held by financial institutions, thereby increasing the effectiveness of the mark-to-market policy’s risk management. The three companies have been rating bonds from November 2000.

Table 1.4 Korean Bond Pricing Agencies

Name	KBP	KIS Pricing	Nice Pricing Services
Capital	W5 billion	W3 billion	W6.55 billion
Largest shareholder	Korea Ratings	KIS	NICE

Sources: Korea Financial Investment Association, Chapter 9 in 2010 *Capital Market in Korea*

c. Effect of Bond Mark-to-Market Valuation

The bond mark-to-market valuation has brought about the following changes in Korea’s bond market:⁵

i. Vitalizing the Secondary Bond Market

With bond transactions being limited to a few issues, the trading of certain issues that had not been purchased or sold recently often plunged due to price uncertainty. However, with the mark-to-market policy resulting in the disclosure of the fair prices of all issues, their prices were benchmarked and trading became reinvigorated. In

⁵ Footnote 1, p. 149–150.

addition, with the price of bonds and the value of funds changing each day, financial institutions started trading bonds proactively, avoiding the previous practice of holding them until maturity.

ii. Energizing of the Primary Bond Market

Previously, trading of corporate bonds was severely restricted, which meant that trading prices were uncertain despite the bond ratings, making setting yields difficult. This depressed lead managers' business and underwriting. However, due to the introduction of the mark-to-market policy, the fair prices of issued corporate bonds given by bond rating agencies are now benchmarked as market prices. This has facilitated greater issuance of corporate bonds.

iii. Facilitation of New Product Development

Providing fair prices for new products that are issued in response to market demands including option embedded bonds, swaps, and structured notes has facilitated the issuance and distribution of these products. It has also enabled the design of structured notes and pricing models to be presented to financial institutions and the market, thereby facilitating investment and new issuances. In addition, it has provided market prices and spot yield curves, which are the basics of risk management and enable prior analysis of risk factors for new products.

iv. Enhancement of Transparency and Expertise of the Investment Trust Industry

The practice of mark-to-market pricing of bonds included in funds has enhanced the transparency of fund management. It has also promoted specialization in bond investment and the rational valuation of investment performance, thereby raising investor awareness of trust products. In addition, through mark-to-market pricing of held bonds, the rational valuation of assets was enabled, providing market values to all bonds held by financial institutions, which increased the effectiveness of the mark-to-market policy's risk management.

H. Bond-Related Systems for Investor Protection

1. Overview

KOFIA places the highest of priority on protecting investors. As a self-regulatory organization, KOFIA promotes discipline and fair practices in the securities markets. It also recommends policies to the government to improve regulations and laws to better protect all market participants, especially investors. KOFIA also contributes to the protection of bond investors through the standard debenture entrustment contract, which sets forth the roles and responsibilities of the trustees, and monitors whether they are maintaining their ability to repay the principal and interest on their loans.

When an event of default occurs to the issuer, which is one of the major details of an entrustment contract based on relevant provisions in the contract, the trustee announces this information to the trust and Bond Information Service (BIS), which enables notification to all the investors.

2. Disclosure in the Secondary Market

a. Disclosure of Over-the-Counter Trade Execution Details

After a brokerage house sells a bond in the OTC market, it must report to KOFIA the details of the transaction within 15 minutes, categorized by the nature of transaction. KOFIA then discloses this information.

The disclosure mandate was introduced in 2000 to enhance market transparency and increasing credibility in trade price. Aspirations towards enhancing market transparency and encouraging more bond derivatives into the market was the reason behind the introduction of the 15-minute rule. Previously, the details of a transaction were reported to KOFIA after 3:00 p.m. when the market was closed. Under such system, transaction details could not serve as market information in a timely manner, undermining discovery function of the appropriate price, which hindered the development of bond derivatives.

In 2000, when the disclosure of trade execution details was introduced, the details of the transaction had to be reported within 30 minutes. This was reduced the following year to within 5 minutes, and then settled to within 15 minutes in 2002. In order to increase the accuracy of reporting details of OTC bond transactions, KOFIA created the Bond-Trade Report and Information Service (B-TriS), which enables real-time management of data between KOFIA and financial investment companies. As of June 2010, an average of 3,724 trade executions was reported daily. The 15-minute rule not only enhanced market transparency, but reduced the cost of searching for price information. Furthermore, it increased the pace of the information distributed through the real-time provision of issues, trading volume, yields, and investor categorization codes, and encouraged more investors to trade bonds.

The disclosure mandate is stipulated under Art. 5–8 of the *FSC Regulation on Financial Investment Business* and the *Regulations on Business Conduct and Services of Financial Investment Companies* of KOFIA (Boxes 1.2 and 1.3).

Box 1.2 Financial Services Commission Regulation on Public Disclosure of Information on Over-the-Counter Trading

Article 5–8. (Public Disclosure of Information on Over-the-Counter Trading)

- (1) The Association (KOFIA) shall systematically manage information about the issuance of bonds and disclose it to the public, such as terms and conditions of issuance that investment traders or investors need for over-the-counter trading.
- (2) The Association shall manage the data of yields from trading bonds in the over-the-counter market, the quote information and the details of trading or brokerage by cases and disclose them to the public, so that investment traders or investors can refer to them for over-the-counter trading.

Source: Financial Services Commission (FSC). 2010. *Regulations on Financial Investment Business*.

Box 1.3 Korea Financial Investment Association Regulation on Reporting on the Records of Over-the-Counter Trading

Article 7-5. (Reporting on the Records of Over-the-Counter Trading, etc.)

(1) A financial investment company engaged in bond trading shall, when trading or brokering bonds with investors in the OTC market, report the records on the case-specific trading and brokering related on such bond trading within 15 minutes from the point of settlement of the sales agreement through the electronic media, etc. to the Association. In this case, the details on the scope of reporting, etc. shall be prescribed by the chairman of the Association.

Source: Korea Financial Investment Association. 26/03/2010. *Regulations on Business Conduct of Financial Investment Companies*.

b. Disclosure of Over-the-Counter Quotation Information

Besides the 15-minute rule, which promotes post-trade transparency, it was also necessary to introduce a service for enhancing pre-trade transparency so that market transparency in general and liquidity could be enhanced. Therefore, KOFIA introduced the Bond Quotation System (BQS) in 2007. At that time, most OTC bond trades were using private messenger services, such as Yahoo and MSN, as a negotiating method. Compared with telephone negotiation, private messenger contributed, in part, to a reduction in bid-ask spreads and increased liquidity. However, it also comprised of multiple messenger groups, and thus dispersed liquidity and made it difficult to access market quotation information in real time. In fact, private messenger served as an entry barrier for new participants such as retail investors and foreigners. Therefore, the government announced the introduction of the disclosure of OTC quotation information in line with the “Reformation of Bond Trading Market” (12 December 2006).

KOFIA requires financial investment firms (including banks and merchant banks), as well as inter-dealer brokers (IDBs), to report, in real time, all the information on quotes and exercise price of all bonds traded in the OTC market through the BQS. Through this system, all OTC quotes are collected and disclosed, enhancing the function of price discovery and increasing transparency and liquidity in the OTC market. Disclosure of quotation information is provided for in Art. 5-9 of the *FSC Regulations on Financial Investment Business* and Art. 7-3 of KOFIA’s *Regulations on Business Conduct and Services of Financial Investment Companies* (Boxes 1.4 and 1.5).

Box 1.4 Financial Services Commission Regulation on Reporting Quote Information

Article 5-9. (Reporting on Quote Information)

Every investment trader or inter-dealer broker shall report quote information and the details of trading or brokerage by case to the Association when engaging in over-the-counter trading or brokerage.

Source: Financial Services Commission. 18/01/2011. *Regulations on Financial Investment Business*.

Box 1.5 Korea Financial Investment Association Regulation on Reporting on the Information on Quotation

Article 7-3. (Reporting on the Information on Quotation)

- (1) A financial investment company engaging in bond trading shall report the information on quotation in relation to OTC trading or the brokering of OTC trading of bonds through the proprietary bond trading system to the Association without delay. [Amended on 26 February 2010]
- (2) Notwithstanding Paragraph (1), in cases where a company falling under Sub-item b of Item 8 of [Article 5-1] of the Regulations on the Financial Investment Business (hereinafter referred to as the "banks, etc." in this Article) trade or broker bonds in the OTC market through a financial investment company engaged in bond trading excluding banks, etc., the reporting shall be substituted by such financial investment company engaged in the bond trading thereof.
- (3) In cases where the Association judges that reporting on the information on quotation cannot be conducted ordinarily due to Acts of God [sic], emergencies and computing errors, etc., it may designate the methods and timing of reporting differently. [Amended on 26 February 2010]
- (4) Details on the scope of reporting on the information on quotation pursuant to Paragraph (1) shall be prescribed by the chairman of the Association. [Amended on 26 February 2010] [The Title of this Article Amended on 26 February 2010]

Source: Korea Financial Investment Association. 2010. *Regulations on Business Conduct of Financial Investment Companies*.

c. Disclosure of Final Quotation Yields

When the market closes, KOFIA posts the yield of each bond that represents the Korean bond market on its BIS. Thus, they can be used as major indices for economic policies, financial institutions' asset management, and the appraisal of investment performance (tallied at 11:30 a.m. and 3:30 p.m. each working day and/or disclosed at 12:00 noon and 3:30 p.m. each working day). The final quotation yield disclosed by KOFIA comprises of the final quotation yields for particular yields to maturity (eight types, 15 yields) and final quotation yields by yield to maturity (five types, 47 yields). In addition, to help energize the OTC bond market, KOFIA discloses base yields that are used for daily closings and derives the final settlement price for government bonds (3-year, 5-year) and MSB (364 days), and market-making quotation yields for bond-specialized dealers. KOFIA also discloses CP issuance information management, yields and indices, Certificate of Deposit (CD) yields and transaction status, customer repurchase agreement (RP) transaction status, and intermediary transactions of RP among institutions. Moreover, since December 1999, KOFIA has announced on a daily basis the KOFIA-Bloomberg Bond Index, an indicator of changes in the bond value of certain groups over time.

From 27 February 2009, KOFIA began to disclose default rates and recovery rates to enhance the price discovery function of the high-yield bond market, and promote the development of new bond-related products, and to use as raw data for risk management. In addition, from June 2009, KOFIA has provided real-time bond indices, enabling real-time assessment of the bond market and the development of new index-linked bond products, including exchange-traded funds (ETFs). Related to this, the first Korean KTB ETF was listed on KRX on 29 July 2009. Art. 7-8 of the KOFIA *Regulations on Business Conduct and Services of Financial Investment Companies* stipulates the disclosure of closing quotes.

Box 1.6 Korea Financial Investment Association Regulation on Disclosure of the Closing Quotes

Article 7–8. (Disclosure of the Closing Quotes)

- (1) The Association shall disclose the closing quotes in each of the following Items through the electronic media, etc.:
 1. The yield of a particular remaining period; and
 2. The yield for each maturity of the remaining period;
 3. [Deleted on July 21, 2009].
- (2) The selection standards of a financial investment company engaged in bond trading to report the yield in relation to the disclosure of the closing quotes and the yield disclosure methods in accordance with Paragraph (1) shall be prescribed by the chairman of the Association.

Source: Korea Financial Investment Association. 26/03/2010. *Regulations on Business Conduct of Financial Investment Companies.*

3. Introduction of the Electronic Disclosure System

KOFIA has played a key role in improving transparency of OTC bond trading and valuation. Starting in July 2002, all securities companies have been required to report trading details to KOFIA within 15 minutes after trading execution. KOFIA has built a sophisticated website (www.kofia.or.kr) which discloses pricing information to public and vendors. Information disclosed include name of the firm, branch number, type of transaction, counterparty, and other details about the securities traded. KOFIA publishes an average of more than 2,000 transactions a day involving W10 trillion to W15 trillion.

To keep the public informed about interest rate movement in benchmark bonds, KOFIA releases on a daily basis two important daily bond yields to the public. The first one, the representative bond yield (RBY), represents a weighted-average yield of certain bonds in terms of trading volume. The second is the final quotation bond yield (FQBY), which is the final yield at which bonds are traded or the last yield quoted for daily transactions. FQBYs of certain types of different bonds are regarded as benchmark yields in the Korean bond markets. FQBYs are currently released twice daily at 12:00 noon and 4:00 p.m.

On 4 December 2007, KOFIA launched the BQS, the OTC BQS, which is a system that collects and disseminates all data pertaining to quote information on OTC trading. With the implementation of the system, quotes are collected in a single, centralized system. This is expected to gradually contribute to better price discovery, and enhance transparency and liquidity in the secondary market. The market rate formed through this system will function as a benchmark rate and improve the efficiency of the secondary market.

Under the existing supervision regulation of securities business, securities companies, banks, and specialized bond brokers are required to report to the KOFIA in real-time the OTC quotes for the bonds they hold. The quote information collected is then released by the KOFIA in real time. As of January 2008, 84 financial institutions report their quotes to the BQS.

From 27 February 2009, KOFIA has disclosed default rates and recovery rates to enhance the price-discovery function of the high-yield bond market, to develop new bond-related products, and to use as raw data for risk management. In addition, from

June 2009, it has announced real-time bond indices, enabling real-time assessment of the bond market and the development of new index-linked bond products including ETFs. Related to this, the first Korean KTB ETF was listed on the KRX on 29 July 2009. As of April 2011, seven types of bond ETFs are listed and traded with a total value of about \$1.3 billion.

I. Listing of Bonds and Medium-Term Notes

1. Criteria

a. Rationale

Bond listings mean that bonds issued on the stock market are allowed to be traded.⁶

b. Advantages of Bond Listings

The advantages of bond listing include:

- i. **Improving public confidence in the issuing firm.** This is made possible by making public the company's operations and information on bond listings.
- ii. **Used as substitute securities and collateral assets.** Listing is used as the consignment guarantee money of stocks, futures, and options trading, and as the deposit money and security deposit to be paid to the public institution.
- iii. **Selected to be incorporated as an investment for financial products.** Financial institutions like investment trusts incorporate mostly listed securities as constituents for funds.

c. Listing Criteria

Bonds are listed in accordance with the provisions specified in the *Listing Regulation*. The KRX lists the bonds whose listing has been requested after careful examination of listing eligibility. Table 1.5 shows the listing criteria for domestic and foreign bonds.

Table 1.5 Initial Listing Criteria for Domestic and Foreign Bonds

Classification	Initial listing of domestic bonds	Initial listing of foreign bonds
Issuing corporation	Corporation with capital stock of at least W500 million. This requirement is not applied to secured bonds, mortgage bonds and asset-backed securities.	It should be a corporation listed on one of foreign exchanges. Listing of foreign stock or Depository Receipts on the stock market or KOSDAQ market of Korea Exchange. Shall be a corporation that has issued the stocks by way of public offering or distribution.
Net Worth	-	Net worth of more than W10 billion. Capital should not have been impaired as of the end of the latest fiscal year.
Public offering or secondary distribution	The bonds should have been issued through public offering or secondary distribution.	The bonds should have been issued through public offering or secondary distribution.
Total amount issued	It should be more than W300 million. In case of secured bonds or mortgage bonds, it should be more than W50 million.	It should be more than W300 million. In case of secured bonds or mortgage bonds, it should be more than W50 million.

continued on next page

⁶ Korea Financial Investment Association. Art. 390 (2) 1 of the FSCMA on listing regulations stipulates that: "Listing regulations shall include... matters regarding listing standards and listing review of securities."

Table 1.5 continuation

Classification	Initial listing of domestic bonds	Initial listing of foreign bonds
Total par value of unredeemed bonds	Total par value of unredeemed bonds should be at least W300 million. In case of secured bonds or mortgage bonds, it should be more than W50 million.	Total par value of unredeemed bonds should be at least W300 million. In case of secured bonds or mortgage bonds, it should be more than W50 million.
Uniform bond certificates	The bond certificates concerned should be the uniform certificates specified in the FSCMA.	-
Denomination of bond certificates	In case of convertible bonds, they should be one denomination (W100,000).	In case of convertible bonds, they should be one denomination (W100,000).
Registered bonds	In case of convertible bonds, it should be registered under the <i>Bond Registration Act</i> .	It should be registered under the <i>Bond Registration Act</i> .
Credit rating	-	Credit rating by a credit appraisal agency should be higher than BBB. ^a

^a Table of corporate bond rating by domestic credit rating organization.
 Notes: Government bonds, municipal bonds, and specific laws bonds are listed when the listing application is received without listing examination. However, the listing criteria are applied to the specific laws bonds that require filing of securities registration statement.
 Source: Korea Exchange, <http://eng.krx.co.kr>

2. Procedure

a. Listing Procedure

Listing application for bonds can be submitted over the Internet using the bond listing system, <http://bonds.krx.co.kr> (available only in Korean). The supplementary documents can be submitted by facsimile or when the securities registration statement is uploaded through the bond listing system. The result can also be confirmed over the Internet. Figure 1.1 illustrates the bond listing system.

Figure 1.1 Bond Listing System

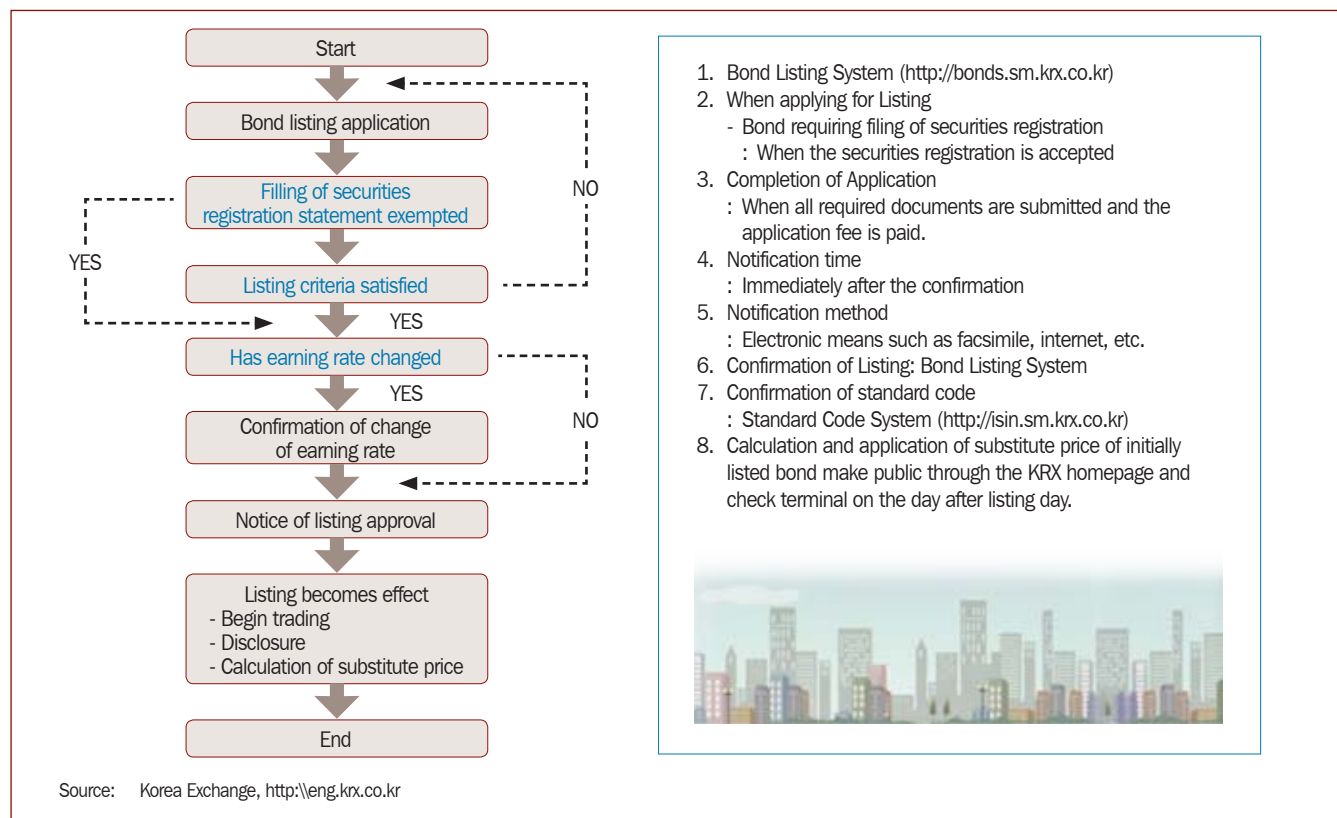

b. Listing of Government Bonds

Government bonds are listed upon receipt of the listing application, without listing examination. Of the government bonds issued presently, Treasury bonds and foreign exchange stabilization bonds are listed on the issuing day according to the regulations governing shelf listing of bonds; the National Housing Bonds (NHB [1 and 2]) are listed on the first day of each month.

Listing of Treasury bonds and foreign exchange stabilization bonds are handled by the Bank of Korea (BOK) over the Internet. Listing of NHBs (1 and 2), on the basis of the application for self-listing for bonds scheduled to be issued during the following year at the end of each year, the Korea Exchange (KRX) lists the scheduled quantity on the first day of each month, and adjusts the listing value upon receiving the notice of issuance value following confirmation of bond issuance for the concerned month.

c. Listing of Municipal Bonds

The same with government bonds municipal bonds are listed without listing examination, taking into account their public benefits. Listing of shelf-listed municipal bonds, i.e., the provincial development bonds and local subway bonds, is handled in the same way as NHBs (1 and 2), and listing of bonds issued through public offering is handled in the same way as corporate bonds.

The documents required for listing application for provincial development bonds and subway bonds are an application for self-listing and a report on result of issuance. The documents required for listing of municipal bonds issued through public offering include an application for listing, trust deed, underwriting agreement or sales contract, a copy of an agreement on offering on commitment (only in case where the concerned bonds are issued through indirect offering). Listing application for bonds can be submitted over the Internet.

d. Listing of Special Bonds

Listing requirements and methods for specific laws bonds differ depending on bond type.

i. Monetary Stabilization Bonds

The same as government bonds, listing application for monetary stabilization bonds is made on the day of sale or bidding, and they are listed on the issuance day.

ii. Shelf-listed Bonds

Industrial financial bonds, Korea National Housing Corporation (land) bonds, and land development bonds are listed as shelf-listed bonds in the same way as local subway bonds, which are municipal bonds. This means, on the basis of application for self-listing for the bonds scheduled to be issued in each month during the following year at the end of each year, the KRX lists the scheduled quantity on a fixed day (for example, on 27th of each month for industrial financial bonds), and adjust the listing value upon receiving the notice of issuance value following confirmation of issuance of bonds for the concerned month.

iii. Public Bonds

Bonds of public corporations are issued indirectly through securities firms. For their convenience, the issuing firms are allowed to compile all bonds issued during the month and submit the listing application for such bonds collectively by 10th of the following month.

iv. Presale Bonds

Listing of presale bonds (bonds are issued together after accumulating all bonds sold during the month, thus their issuing date is same, but sale dates are different), which are bank bonds, is handled as a shelf listed bond until June 2001. However, with the abolition of the taxation regulations concerning the holding period in July 2001, presale bonds are listed by giving a different name to each sale date (with same issuing date).

v. Bonds Requiring Filing of Securities Registration Statement

Filing of the securities registration statement was exempted for the merchant bonds, card bonds, lease bonds, discount financial bonds, and new technology financial bonds. Such bonds issued during the month were accumulated and listing application was made by 10th of the following month. However, with the amendment of the *Securities and Exchange Act (SEA)* in July 2001, the filing of the securities registration statement became an obligation. Consequently, in accordance with the bond issuance plan for a fixed duration (up to 1 year period), issuers of such bonds has to file an application for self-listing with the Financial Services Commission (FSC), and an application for additional self-listing has to be filed every time bonds are issued during the specified period. Listing application should be made after filing the application for additional self-listing.

e. Listing of Corporate Bonds

Corporate bonds are required to list on the issuing day and the issuing firms submit a listing application; the KRX then lists the bonds after listing examination. Listing application should be made after the FSC has accepted the securities registration statement.

f. Listing of Foreign Bonds

Foreign bonds refer to the bonds issued by a foreign legal entity (including foreign corporations established in accordance with foreign governments, foreign municipal governments, foreign public organizations and foreign status and laws, as well as the international financial bodies established by an international convention). Because of the difficulties involved in assessing the trustworthiness and/or soundness of foreign corporations, listing of foreign bonds requires a careful listing examination. Accordingly, in order to ascertain the facts that issuing conditions of bonds meet the requirements for investor protection and are compatible with the listing and trading systems of the KRX, anyone who intends to list foreign bonds is required to consult with the KRX on matters such as listing procedures and time prior to submission of an application. This process also enables initiation of appropriate measures.

3. Application Form

a. Application Form

The applicant for the initial bond listing must submit the initial bond listing application form (bond listing request for national bonds) and attached documents.

b. Related Documents

- i. Samples such as government bonds, municipal bonds, monetary stabilization bonds, and specific laws bonds that are continually issued for sale throughout the month are submitted only once but are omitted when issuing registered bonds.
- ii. For indirect issuers, copies of the trust instrument, acceptance contract, or sales contract, and collection consignment contract.
- iii. Business description (including corrections to statements)
- iv. Financial statements and auditor's reports for the past 3 business years
- v. Auditor's report on the financial statements of the most recent business year
- vi. Documents that verify the payment of bond
- vii. Miscellaneous documents deemed necessary by the KRX

Exempted Documents are:

- i. Documents (iii) to (vii): Municipal bonds of secondary distribution, specific laws bonds (except for specific laws bonds that submit the securities registration statement), and bonds that are exempted from filing the securities registration statement.
- ii. Documents (iv) to (v): Guaranteed bonds and non-guaranteed bonds that submit business reports based on Art. 159 of the Financial Investment Services and Capital Market Act (FSCMA).
- iii. Documents (ii) to (v): If securities registration statement that has come into effect has been submitted.

c. Application Form for Foreign Bonds

Application documents for foreign bonds include:

- i. As defined in statutes or appropriate documents
- ii. For indirect issuers, copies of the trust instrument, acceptance contract, or sales contract, and collection consignment contract
- iii. Copy of the assignment contract as a listing representative
- iv. Auditor's report, or comparable documents, on the financial statements for the past 3 business years
- v. Copy of the credit rating report
- vi. Miscellaneous documents deemed necessary by the KRX

Documents (i) to (vi) are exempted if securities registration statement that has come into effect have been submitted.

d. Methods for Submitting Documents

Documents may be submitted through the following:

- i. Mail, by means of someone, electronic document or fax.
- ii. Among the accompanying documents that must be submitted, those that were not submitted at the time of the listing application may be submitted within 3 days after the concerned bond is issued.

4. Listing Fees and Annual Dues

a. Rationale

The KRX collects listing fees from institutions that apply for bond listings. The purpose of the fees that must be paid when listing is for the KRX to maintain the various expenses required to provide all sorts of services to the issuing institution. Included are listing fees and annual dues.

b. Listing Fees

i. Initial Listing Fees

The following amounts are applied for listing amounts classified by issue using face values when calculating initial listing fees for bonds (Table 1.6). However, for shelf-listed bonds and non-shelf-listed bonds, the monetary amount for listing bonds issued on the same day continuously throughout the month is calculated by assigning bonds issued on the same day as one issue by each listing request date. Listing fees are paid when the listing request is made. For shelf-listed bonds, they are paid when the results for the issue are announced.

Table 1.6 Listing Fees

Listing Amount (W billion)	Listing Fees (W thousand)
<1	100
≥1 and <2	150
≥2 and <5	300
≥5 and <10	700
≥10 and <15	1,000
≥15 and <25	1,200
≥25 and <50	1,300
≥50 and <100	1,400
≥100 and <200	1,500
≥200 and <500	1,600
≥500	1,700

Source: Korea Exchange, <http://eng.krx.co.kr>

ii. Listing Change Fees

Bond listing corporations that change listed bonds due to mergers, spin-off, or business transfers, and corporate name changes are charged with change listing fees of W300,000 per bond.

iii. Relisting Fees

Bonds that are applicable to bond delisting standards due to bankruptcy, etc. are delisted. However, if the cause for delisting is solved and the bond is relisted, then a fee of W300,000 is charged per bond.

c. Annual dues

The total annual dues during the remaining repayment period for bonds must be paid in advance at the time of the listing application; for shelf-listed bonds, annual dues are paid when the issue results are announced. In this case, monetary amounts (rounded to the lowest W100) calculated by monthly installments (rounded down to the lower month) are used for remaining repayment periods of less than a year. If the remaining repayment period is greater than 5 years, then the monetary value is calculated based on 5 years.

The standard charges and fees for the annual dues of bonds are based on the listing date (relisting date) and charged W100,000 for the remaining repayment periods of 1 year per each issue. However, for shelf-listed bonds and non-shelf-listed bonds, annual dues for the amount of bonds issued on the same day continuously throughout the month are based on the issuing date.

The dues are charged by assigning the amount of bonds issued on the same day-month one issue, categorizing them by interest payment methods and by remaining repayment periods.

d. Fee Exemptions and Restoration

The following are fee exemptions and restoration:

- Listing fees and annual dues: Government bonds, municipal bonds, and monetary stabilization bonds.
- Annual dues: Bonds that exist for less than a year from the listing date; bonds that are issued by KRX securities trading members (excluding bond specialist members).
- Change listing fees are imposed on listed bonds of corporations when listings change (changes to listings) due to changes to stocks and due to mergers of the listed corporation's stock certificate occur.

e. Restoration

The KRX restores the listing fees and annual dues (pursuant to Clause 4) for bonds that are denied their listing applications. Corporations that list bonds must follow the stipulations agreed to in the listing contract when their bonds are delisted during the remaining repayment period and have already been prepaid for.

According to the notifications for the cause of delisting and the restoration of annual dues, monthly installments up to the delisting date are deducted from the total annual dues paid and the remaining amount is restored to the corporation (rounded to the lowest W100).

More details on listing fees and dues can be found under Rules and Regulations in the Korea Exchange website.⁷

⁷ Korea Exchange. www.krx.co.kr

J. Governing Laws on Bond Issuance

The *Regulation on Securities Issuance and Disclosure (RSID)*, enacted in February 2009, is an FSC regulation that overhauled the *Regulation on the Issuance and Disclosure of the Securities* by adding regulatory improvements and additional authorities entrusted by FSCMA.

To ensure the fairness of securities issuance and investor protection, RSID specifically defines items which investors should be notified of in the form of descriptions on the registration statement and investment prospectus, along with the forms and other documents they should accompany. In particular, when it comes to the registration statements of collective investment securities and asset-backed securities (ABS), and the registration statement on mergers, business transfers and split-offs, split-and-mergers, comprehensive exchanges or transfer of stocks, RSID defines different specifics and required documents.⁸

K. Related Legal and Regulatory Issues of the Market

1. Legal and Regulations in the Korea Bond Market

a. Financial Investment Services and Capital Market Act

In February 2009, Korea's financial regulatory structure witnessed a fundamental change in with the enforcement of the Financial Investment Services and Capital Market Act (FSCMA). In order to promote fair market competition, financial innovation and stricter investor protection, FSCMA drastically altered the regulatory framework of the Korean capital market.

With its implementation, the previous major capital market laws such as *SEA*, *Futures Trading Act*, *Korea Securities and Futures Exchange Act*, *Indirect Investment Asset Management Act*, *Trust Business Act*, and *Merchant Banks Act* were all abolished and replaced by FSCMA.

b. Regulations on Securities Underwriting Business

The *Regulations on Securities Underwriting Business*, enacted in December 2008, is a KOFIA regulation that stipulates the obligations of underwriters (securities companies) to protect investors. The obligations are created under KOFIA's self-regulation function with the aim of maintaining order in the primary market, and regulating underwriting business practices among members companies.⁹

2. Purpose of Regulations

The purpose of these regulations is to prescribe necessary matters in conducting securities underwriting business in accordance with Art. 286(1) of the FSCMA by financial investment companies that have received accreditation for financial investment business from the FSC, or those that engage in such business by registering with the FSC.

⁸ Footnote 1, p. 316.

⁹ Korea Financial Investment Association. 2008. *Regulations on Securities Underwriting Business*.

L. Self-Governing Rules of the Market

1. Self-Regulatory Organizations

a. Korea Financial Investment Association (KOFIA)

The KOFIA is an incorporated membership organization with the purpose of maintaining business order between members, assuring fair trade, protecting investors, and promoting the sound development of financial investment services. Members of the association are financial investment firms, general administration companies, collective investment scheme assessment companies, bond assessment companies, and members under the conditions prescribed by its Articles of the Association. KOFIA aims to promote fair business practices among member companies, create a fair business culture in the securities trading market, and maximize the function of investor protection. As such, KOFIA undertakes such activities as self-regulation to protect investors and maintain market order among member companies; dispute mediation between members regarding their business activities; registration and management of investment advisers and managers; OTC trading management for non-listed stocks and non-listed bonds; and establishment of dispute mediation rules for the industry's self-mediation of conflicts.

b. Korea Exchange

KRX is a stock company, which aims to fix and stabilize fair prices in the transactions of securities and exchange-traded derivatives, and facilitate the stability and efficiency of other transactions. It established and operates the stock market, the KOSDAQ market, and the futures market.

Under FSCMA, the stock market is a market established for the trading of securities, such as debt securities, equity securities, beneficiary securities, investment contract securities, derivative-combined securities, and securities depository receipts. KOSDAQ was established for the trading of specific securities designated by FSCMA, such as corporate bonds and stocks. Therefore, the stock market and KOSDAQ differ in the kinds of stocks they deal. The futures market is a market established by the KRX for trading exchange-traded derivatives.

The responsibilities of KRX include:¹⁰

- i. the establishment and operation of the stock market, KOSDAQ, and the futures market;
- ii. transactions of securities and exchange-traded derivatives;
- iii. transaction confirmation;
- iv. debt acquisition;
- v. deduction;
- vi. confirmation of settlement securities, settlement item, and settlement amount;
- vii. settlement execution guarantees;
- viii. follow-up measures on settlement failure and settlement instruction as a result of transactions on the securities market and the derivatives market;
- ix. report and disclosure of a listed corporation; and
- x. self-resolution of disputes arising from transactions in the stock market, KOSDAQ, and the futures market.

¹⁰ Footnote 1, p. 320–321.

II. Primary and Secondary Market-Related Regulatory Framework

A. Related Rules and Regulations on Issuing Debt Instruments

1. Disclosure requirements

In the preparation and disclosure of an investment prospectus, Art. 123 of the *Financial Investment Service and Capital Market Act (FSCMA)* states that:¹¹

When an issuer publicly offers or sells securities in accordance with Article 119, the issuer shall file an investment prospectus (hereinafter referred to as “investment prospectus”), prepared in accordance with the manner prescribed by Presidential Decree, with the Financial Services Commission (FSC) on the day on which the relevant registration statement becomes effective (or the day on which the supplements to a universal shelf registration statement are filed, in cases where the supplements to the universal shelf registration statement shall be filed in accordance with Article 119 (2) and keep it at a place specified by Ordinance of the Prime Minister to make it available to the public for inspection.

<Amended by Act No. 8863, Feb. 29, 2008>

No investment prospectus shall contain any description different from the one described in the relevant registration statement (including any supplements to a universal shelf registration statement under Article 119 (2); hereafter the same shall apply in this Chapter) or omit any description stated therein: Provided, that a description of the balance between confidentiality in corporate management, etc. and protection of investors, etc., as prescribed further by Presidential Decree.

An issuer of the collective investment securities specified by Presidential Decree shall file an additional investment prospectus separately from the one under paragraph (1) in accordance with the following subparagraphs, with the Financial Services Commission (FSC), and shall keep it at a place specified by Ordinance of the Prime Minister to make it available to the public for inspection: Provided, that such filing, keeping, and disclosure

¹¹ Chapter I, Part III of the *Financial Investment Service and Capital Market Act*.

may be omitted, if offering or selling such collective investment securities is discounted:

<Amended by Act No. 8863, Feb. 29, 2008>

A revised investment prospectus shall be filed at least once after the investment prospectus under paragraph (1) is filed within an interval prescribed by Ordinance of the Prime Minister; and

In cases where an amendment to registration is filed in accordance with Article 182 (8), an investment prospectus in which such amendment is reflected shall be filed within five days after a notice of amended registration is delivered.

2. Credit Rating Requirements

Regulation 11 of the *Regulations on Securities Underwriting Business* provides for the credit rating requirements of non-guaranteed bonds. Chapter III of the regulation states that:¹²

In the case of an underwriter underwriting non-guaranteed bonds, such bonds shall be those that have been rated by at least two (one agency, in the case of underwriting ABS issued in the form of bonds pursuant to the Act on ABS or in inevitable cases such as the business suspension of credit rating agencies) credit rating agencies from among those approved for the credit ratings business pursuant to the provisions of the Act on Use and Protection of Credit Information.

However, non-guaranteed bonds issued by foreign corporations, etc., shall be deemed as those rated in accordance with this provision if they are rated by two or more credit rating agencies (referring to international credit rating agencies as prescribed by the Governor of the Financial Services Commission (FSC) in the Item of [§2-11(2)1] of the FSC's Regulations on Securities Issuance and Disclosure; the same hereinafter in this chapter).

3. Lead Time for Registration Approval

The minimum lead time (number of business days) for registration approval is provided for in Art. 120 of the FSCMA, which states that:¹³

The registration of securities under Article 119 (1) and (2) (hereinafter referred to as "securities registration") shall be effective on the day after the expiration of the time period prescribed by Ordinance of the Prime Minister, considering the type of securities or the characteristics of the transaction, etc., which shall begin on the day on which the registration statement is submitted and accepted by the Financial Services Commission. <Amended by Act No. 8863, Feb. 29, 2008>

The Financial Services Commission (FSC) shall not refuse to approve a registration statement, unless it is not prepared in conformity with the

¹² Regulation 11 on Underwriting of Non-Guaranteed Bonds, Chapter III of the *Regulations on Securities Underwriting Business*.

¹³ Footnote 12, Art.120 on "Effective Date of Registration Statement, etc."

prescribed form of the registration statement, there is any false description or representation in the registration statement concerning a material fact, or any description or representation of a material fact is omitted.

<Amended by Act No. 8863, Feb. 29, 2008>

The effectiveness under paragraph (1) shall not include any effect of acknowledging that the descriptions of the relevant registration statement are true or correct, or the Government's assurance or approval of the value of the securities.

An issuer of securities shall, when it intends to withdraw its securities registration, file a withdrawal statement with the Financial Service Commission (FSC) no later than the day before the date set for offering to acquire or purchase the securities stated in the relevant registration statement.

<Amended by Act No. 8863, Feb. 29, 2008>

4. Availability of Shelf Registration and Associated Documentation Requirements

If the bond issuer uses the shelf registration, the bond issuer must submit the “universal shelf registration statement” to the Financial Services Commission (FSC). The legal provision for shelf registration is stipulated at Art. 119 (2) in FSCMA, which states that:¹⁴

When a registration statement for a total amount of securities to be publicly offered en bloc over a certain period of time (hereinafter referred to as “universal shelf registration statement”) in accordance with the guidelines and methods prescribed by Presidential Decree, considering the type of securities, scheduled issue period, frequency of issuance, requirements for the issuer, etc., is submitted to and accepted accordingly by the Financial Services Commission (FSC), such securities may be publicly offered or sold without necessarily submitting a registration statement each time such securities are publicly offered or sold during the period of time stated therein, notwithstanding paragraph (1).

In such cases, the documents related to the universal shelf registration statement (hereinafter referred to as “supplements to universal shelf registration statement”), as prescribed by Presidential Decree, shall be submitted each time such securities (excluding collective investment securities, specified by Presidential Decree) are publicly offered or sold.

<Amended by Act No. 8863, Feb. 29, 2008>

5. Regulated Suspension Period

The maximum regulated suspension period is 6 months. The suspension period is imposed by the Financial Supervisory Service (FSS), if some financial investment institutions violate the regulation or the FSCMA.

¹⁴ Footnote 12, Art. 119 (2) on “Registration of Public Offering and Sale.”

B. Regulations and Rules related to Buying Debt Instruments in the Secondary Market

1. Continuous Disclosure Rules or Requirements

Art. 33 on “Business Report and Public Disclosure” of FSCMA states that:¹⁵

A financial investment business entity shall prepare business reports for three, six, nine, and twelve months respectively from the commencement date of each business year, and shall submit them to the Financial Services Commission (FSC) within the period of time prescribed by Presidential Decree, not exceeding 45 days after the lapse of each relevant term as specified above.

<Amended by Act No. 8863, Feb. 29, 2008>

A financial investment business entity shall keep a summary of the business reports submitted under paragraph (1) containing the material facts of each business report for public disclosure, in the head office, branch offices, and sales offices for one year from the date on which the report is submitted to the Financial Services Commission (FSC), and shall also disclose it to the public through its Internet homepage, etc.

<Amended by Act No. 8863, Feb. 29, 2008>

In the event that anything that is likely to produce a significant impact on the business management status of a financial investment business entity, such as occurrence of any massive financial scandal or non-performing claims, as prescribed by Presidential Decree for each type of financial investment business, the financial investment business entity shall report it to the Financial Services Commission (FSC), and shall disclose it to the public through its Internet homepage, etc.

<Amended by Act No. 8863, Feb. 29, 2008>

A financial investment business entity shall submit reports indicating monthly business affairs in addition to business reports under paragraph (1) to the Financial Services Commission (FSC) by the end of the next month.

<Newly Inserted by Act No. 9407, Feb. 3, 2009>

Matters concerning the business reports submitted under paragraph (1), the descriptions contained in the document for public disclose under paragraph (2), and the public disclose of the business management status under paragraph (3), the reports submitted under paragraph (4) and other necessary matters shall be prescribed by Presidential Decree.

<Amended by Act No. 9407, Feb. 3, 2009>

¹⁵ Art. 33 on “Business Report and Public Disclosure, etc.,” Section 1, Chapter III, Part II of the *Financial Investment Service and Capital Market Act*.

2. Restrictions for Investors

a. Licensing

Pursuant to Article 12 (1) of FSMCA, an entity that wishes to run a licensed financial investment business shall select all or part of its business units for licensing from FSC. A single business unit can be defined through the combination of factors such as the types of financial investment business, the scope of financial investment products, and classes of investors. More specifically, the constituents of financial investment business are the six types of investment business such as investment trading, investment brokerage, collective investment, investment advisory, trust, and discretionary investment business. The product scope consists of securities, exchange-traded derivatives, and over-the-counter (OTC) derivatives. Investors are divided into ordinary and professional investors.

In addition, in accordance with Article 18 (1) of FSCMA, an entity that wishes to operate a registered financial investment business shall create a single business unit by combining the aforementioned three factors and select all or part of the business units for registration with FSC as a financial investment business. The Enforcement Decree of FSCMA sets forth the minimum level of net assets required to run each licensed or registered business unit based on the associated risk and the required level of investor protection for each service. For example, a higher level of minimum net assets is required for investment trading and trust services, compared to investment brokerage and collective investment services, respectively. Likewise, as the registration of a business unit is a relaxed means of an entry, it requires a lower level of minimum net assets than a licensed business unit.

With regard to the financial investment instrument, OTC derivatives require the highest level of net assets. Between securities and exchange-traded derivatives, securities require a higher minimum level of net assets due to the more frequent release of new products on the market. In addition, the minimum net asset requirement is reduced to half of financial investment firms to add more services, grow in size, and enhance their expertise through lowered entry barriers.

Based on the Enforcement Decree, if a financial investment company launches an investment trading service that handles debt securities, equity securities, beneficiary securities, derivatives-combined securities, and securities depository receipts, the company should hold a minimum account of net assets of W50 billion. But in the case of only managing debt securities, the net asset requirement is W20 billion, while equity securities business (excluding collective investment securities) alone requires a minimum net asset of W25 billion. Table 2.1 shows the minimum net asset requirement for an investment trading business.

Table 2.1 Minimum Net Asset Requirement for Investment Trading Business (W Billion)

Business Area	Financial Investment Product	Minimum Net Assets (ordinary and professional/professional)
Trading	Securities ¹	50/ 25
Trading	Debt securities ²	20 / 10
Trading	State, local government and special bonds	7.5 / 3.75
Trading	Equity securities (excluding collective investment securities)	25 / 12.5
Trading	Collective investment securities	5 / 2.5
Trading	Exchange-traded derivatives	10 / 5
Trading	Exchange-traded derivatives (securities for underlying asset)	5 / 2.5
Trading	OTC derivatives	90 /45
Trading	OTC derivatives (securities for underlying asset)	45 / 22.5
Trading	OTC derivatives (non-securities for underlying asset)	45 / 22.5
Trading	OTC derivatives (currency/interest rates for underlying asset)	18 / 9
Trading (Excluding underwriting)	Securities ¹	20 / 10
Trading (Excluding underwriting)	Debt securities ²	8 /4
Trading (Excluding underwriting)	State, local government and special bonds	3 / 1.5
Trading (Excluding underwriting)	Corporate bonds	4 / 2
Trading (Excluding underwriting)	Equity securities (excluding collective investment securities)	10 / 5
Trading (Excluding underwriting)	Collective investment securities	2 / 1
Trading (Excluding underwriting)	Repurchase agreement (RP) ³	6 (Professional)
Trading (Excluding underwriting)		6 / 3

¹ Securities mean financial investment instruments that comprehensively cover debt securities, equity securities, beneficiary certificates, derivatives-combined securities and securities depository receipts (Article 3 of FSCMA).
² Debt securities include state bonds, local government bonds, special bonds, corporate bonds and corporate commercial papers.
³ Financial instruments for RP include government bonds, public offering bonds issued by listed companies and state-owned companies, guaranteed bonds, ABS and MBS for public offering and beneficiary certificates.
Source: Korea Financial Investment Association, Chapter 12 in 2010 *Capital Market in Korea*.

For the brokerage business, the minimum net asset requirement is W1 billion with the amount halved to W500 million if the company only targets professional investors who require relatively lower levels of protection. Based on this formula, a company that wants to carry out both brokerage and dealing will require a total net asset of W11 billion, which is broken down to W1 billion for brokerage and W10 billion for dealing. Table 2.2 shows the minimum net asset requirements for investment brokerage business.

Table 2.2 Minimum Net Asset Requirement for Investment Brokerage Business (W Billion)

Business Area	Financial Investment Product	Minimum Net Assets (ordinary and professional/professional)
Brokerage	Securities ¹	3 / 1.5
Brokerage	Debt securities ²	1 / 0.5
Brokerage	Equity securities (excluding collective investment securities)	1 / 0.5
Brokerage	Collective investment securities	1 / 0.5
Brokerage	Repurchase agreement (RP) ³	0.5 (Professional)
Brokerage	Exchange-traded derivatives	2 / 1
Brokerage	Exchange-traded derivatives (securities for underlying asset)	1 / 0.5
Brokerage	OTC derivatives	10 / 5
Brokerage	OTC derivatives (securities for underlying asset)	5 / 2.5
Brokerage	OTC derivatives (non-securities for underlying asset)	5 / 2.5
Brokerage	OTC derivatives (currency /interest rates for underlying asset)	2 / 1
Brokerage (ECN)	Listed securities	15 / 7.5
Brokerage (OTC bond transaction)	Securities; debt securities	3 (Professional)

¹ Securities mean financial investment instruments that comprehensively cover debt securities, equity securities, beneficiary certificates, derivatives-combined securities and securities depository receipts (Article 3 of FSCMA).
² Debt securities include state bonds, local government bonds, special bonds, corporate bonds and corporate commercial papers.
³ Financial instruments for RP include government bonds, public offering bonds issued by listed companies and state-owned companies, guaranteed bonds, ABS and MBS for public offering and beneficiary certificates.
Source: Korea Financial Investment Association, Chapter 12 in 2010 *Capital Market in Korea*.

For the collective investment business, a company must have a minimum net asset of W8 billion to run all types of funds such as equity funds (including money market funds), real estate funds, special assets funds, and mixed assets funds. However, only W2 billion is required to run a single type of fund, such as real estate funds or special assets funds.

In the trust business, net assets of W25 billion are required if a financial investment company is to manage all types of trust properties, while monetary trust alone requires only a minimum of W13 billion in net assets.

For registered businesses such as investment advisory and discretionary investment services, a minimum net asset of W500 million and W1.5 billion are required, respectively. In addition, if a bank or an insurance company wishes to offer financial investment services concurrently, the minimum net asset requirements for the services should be examined based on an amount with the capital requirements for banking or insurance business (as prescribed in the banking act or the insurance act) deducted.

Table 2.3 Minimum Net Asset Requirement for Collective Investment, Trust, Investment Advisory, and Discretionary Investment Businesses (W Billion)

Business Area	Financial Investment Product	Minimum Net Assets (ordinary and professional/professional)
Collective investment	Securities collective investment scheme (CIS) Real estate CIS Special asset CIS Mixed assets CIS Short-term finance CIS	8 / 4
Collective investment	Securities CIS Short-term finance CIS	4 / 2
Collective investment	Real estate CIS	2 / 1
Collective investment	Special asset CIS	2 / 1
Trust	Money, securities, monetary claims, movables, real estate, rights related with real estate, intangible property rights	25 / 12.5
Trust	Money	13 / 6.5
Trust	Securities, monetary claims, movables, real estate, rights related with real estate, intangible property rights	12 / 6
Trust	Movables, real estate, rights related with real estate	10 / 5
Investment advisory	Securities, exchange-traded derivatives, OTC derivatives	0.5 / 0.25
Discretionary investment	Securities, exchange-traded derivatives, OTC derivatives	1.5 / 0.75

Source: Korea Financial Investment Association, Chapter 12 in 2010 *Capital Market in Korea*.

3. Definition of Qualified Institutional Investors and Professional Investors

The government is currently looking into the implementation of the Qualified Institutional Buyer (QIB) system in the Korean bond.

4. Requirements and Restriction for Non-residents

a. Foreign Investor Registration

Foreign investors who wish to acquire or dispose of securities listed on the securities market, or securities offered or sold for listing, must register with the FSS. The documents required by FSS should be submitted in person or through a local agent¹⁶ and an investment registration certificate (IRC) will be issued. After submitting an IRC, a licensed local investment dealer or investment broker may open an account for securities trading on behalf of foreign investors. Under the respective laws, including the FSCMA, foreign investors are permitted to acquire securities within certain investment ceilings. Currently, they can invest in 37 stock issues of 36 companies as of 30 November 2009.

Foreign investor registration aims to manage the matters pertaining to foreign investment limits and other related issues. Through the system, statistics on foreign investment including foreign holdings will also be managed. Furthermore, the IRC is used to authenticate the real name of an investor when opening an account.

¹⁶ This is based on Art. 6-22 of the *Regulations on Financial Investment Business*. Foreign investors may designate their respective local agent to represent them in exercising their rights on the securities acquired and in handling other related matters. Any one of the entities listed below may be designated as a local agent for a foreign investor: Korea Securities Depository, foreign exchange banks, investment dealers, investment brokers, collective investment managers, and internationally recognized securities depository institutions. No other person or entity may be appointed a local agent by a foreign investor. A designated agent shall fulfill its fiduciary duty.

Table 2.4 Questions and Answers on Investment Registration Certificate and Documentation

Q&A related to IRC/Documentation (Answered by FSS)	
Questions	Answers ^a
IRC concept: IRC concept being reviewed by FSS; good news and should be projected to FIIs; what timeline for review (even if no exact date?)	The FSS is always open to comments and suggestions by foreign investors. As an effort to ease the IRC process for foreign investors, the FSS currently operates [an] electronic registration system for foreign investors where foreign investors/custodians can submit IRC application and the required documents on-line [sic]. At this time the FSS does not have an official comment to make with regards to IRC but the FSS welcomes opinions of foreign investors and that we try to seek measures that may make the Korean financial market more accessible to foreign investors.
Granting of IRC: Is there an official FSS commitment on turnaround or which should be official version for SF1 market guide?	The FSS tries not to create any unnecessary delays with the IRC granting process and if all the required documents have been submitted, it usually takes no more than four hours (4 hrs) [sic].
IRC process: Participants mentioned 'upon presentation of documents' or similar; does that mean that docs have to actually be submitted to FSS or only to custodian who then bears sole responsibility and applies online?	The documents may be submitted to FSS by the investor or through the custodian who is acting on behalf of the investor. The documents can either be submitted either in person or through the FSS online system.
^a Provided by Financial Supervisory Service. FII = foreign institutional investors; FSS = Financial Supervisory Service; IRC = investment registration certificate; SF1 = Sub-Forum 1 Source: <Please indicate source>.	

b. Investors Subject to Registration

Generally, individuals of foreign nationality who have not maintained residence in Korea for more than 6 months will be subject to registration if they intend to invest in listed securities. The same applies to corporations. Any corporation that does not have an office in Korea and was established according to foreign laws must register in order to invest in listed securities in Korea. This means that citizens residing outside Korea need not register for an IRC because of their Korean nationality. However, foreign corporations (local subsidiaries) established by Korean nationals are viewed as foreign entities; therefore they must register with the FSS for an IRC. In addition, the main office and branch offices (except branch offices established within Korea) of a foreign corporation are viewed as a single foreign entity and are only required to have one IRC issued.

In the case of funds, however, a master fund and sub-fund cannot be registered together according to Art. 6–10(2) of the *Regulations on Financial Investment Business*, in order to ensure the effectiveness of investment registration. If they are registered together, a single beneficiary owner may eventually have more than two certificates. However, when a master fund is not yet registered, each sub-fund is able to register individually since these sub-funds are considered separate beneficiary owners.

Box 2.1 to 2.3 show the relevant laws regarding investors subject to registration.

Box 2.1 Definition of Foreign Corporation

Article 9 (Definition of Other Terms)	<p>The term “foreign corporation, etc.” in this Act shall mean a person falling under any of the following subparagraphs:</p> <ol style="list-style-type: none"> 1. Foreign government; 2. Foreign municipal government; 3. Foreign public organization; 4. Foreign company established under foreign Acts and subordinate statutes; 5. International institution designated by the Presidential Decree; or 6. Other corporations located in a foreign country as designated by the Presidential Decree.
Source: Financial Investment Services and Capital Markets Act.	

Box 2.2 Scope of Foreign Corporation

Article 13 (Scope of Foreign Corporation)	<ol style="list-style-type: none"> (1) The term “international institution designated by the Presidential Decree” under Article 9(16) (v) of the Act shall mean an international institution established in accordance with a treaty. (2) The term “corporations located in a foreign country as designated by the Presidential Decree” under Article 9(16)(vi) of the Act shall mean those falling under any of the following subparagraphs: <ol style="list-style-type: none"> 1. A fund or association established, supervised or managed in accordance with foreign Acts and subordinate statutes; 2. A fund or association established, supervised or managed by a foreign government, foreign municipal government or foreign public organization; or 3. A fund or association established, supervised or managed by an international organization established in accordance with a treaty.
Source: Enforcement Decree of the Financial Investment Services and Capital Markets Act.	

Box 2.3 Definition of Foreign Nationals

Article 6-1. (Definitions)	(1) The term “foreign national” refers to a private individual of foreign nationality without his/her domicile, or abode in Korea for six months or longer, or a foreign legal entity as defined in Article 9(16) of the Act.
Source: Financial Services Commission. 16 November 2011. <i>Regulations on Financial Investment Business</i> .	

c. Exemption from Registration

Foreign nationals, foreign-incorporated entities, or local branches of a foreign corporation engaging in business activities in the Republic of Korea that qualify as “foreigner under national treatment” status shall be exempt from registration upon submitting documents verifying their status. Registration will also be exempted in the case of acquiring stocks on the OTC market for the purpose of “direct investment,”¹⁷ as well as disposing of direct investments, but the details of the relevant transactions must be reported promptly to the FSS.

¹⁷ This is based on Article 2(1)(iv)(a) of the *Foreign Investment Promotion Act*. In general, with the amount of the foreign investment being W50 million or more, the term “foreign investment” shall refer to where a foreign investor purchases 10% or more of holdings of a Korean corporation or where a foreign investor purchases holdings after signing such contracts as a management participation contract or a research and development contract with a Korean corporation.

Exemption from registration will also apply to cases where government bonds and market stabilization bonds are acquired and sold by using “omnibus accounts” under the name of the International Central Securities Depository (ICSD)¹⁸ while having an ICSD account at the same time. Box 2.4 below provides the definition of omnibus account on foreign investment in bonds and Box 2.5 provides the regulations regarding exemptions from registration.

Box 2.4 Definition of Omnibus Account Regarding Foreign Investment in Bonds

When foreigners intend to engage in bond trading activities, they entrust the International Central Securities Depository (ICSD) with custodial and settlement services. The ICSD then opens an account with the country of the investment destination under its own name to carry out investment services, such as managing customers' accounts and making orders. Such an integrated account is referred to as an omnibus account. Though the account is opened under the ICSD's own name, the beneficiary owners of the investment capital are those customers (foreigners), involved in transactions with the ICSD. Therefore, the ICSD carries out securities investment on behalf of its customers, and the profits will be returned to the customers.

With the amendment to the old Regulations on Supervision of Securities Business, the exemption of registration has been made applicable to individual investors if they engage in the trading of government treasury bonds and monetary stabilization bonds through a Euroclear or Clearstream omnibus account. Also, the trading of treasury bonds and monetary stabilization bonds among foreigners is possible when they use an ICSD account. Additionally, with the amendment to the Detailed Rules of the Regulations on Financial Investment Business, institutional improvements have been made to support foreign investment in bonds. Such improvements include easing the reporting obligation for foreign investors when they engage in bond transactions through an omnibus account.

Source: Korea Financial Investment Association, Chapter 14 in *2010 Capital Market in Korea*.

Box 2.5 Regulations Regarding Exemptions from Registration

Article 6-1. (Definitions)	1. The term “foreigner treated as a citizen” refers to any of the following foreigners: provided that excluded herein are non-residents as defined in Article 10(2)(i),(ii), and(vi6) of the Enforcement Decree of the Foreign Exchange Transaction Act: <ol style="list-style-type: none"> A person who works in a business office or any other office in Korea or who engages in any business activity in Korea; and A foreign legal entity that has its principal place of business in Korea or a domestic branch office, liaison office, or any other office of a foreign legal entity;
Article 6-10. (Application for Registration of Investment)	(2) Notwithstanding paragraph (1), the registration of investment is not required in any of the following cases: <ol style="list-style-type: none"> Where it is intended to dispose of stocks acquired by exercising a right to overseas securities within three months from the date of acquisition; Where it is intended to acquire or dispose of stocks in connection with direct investment: provided that the cases where stocks are acquired from the securities market are excluded herein; and Where it is intended to acquire or dispose of state bonds or monetary stabilization bonds through an account opened in the Korea Depository in the name of an international depository and clearing organization that has completed the registration of investment; provided that, excluded herein are cases where the obligation to report is waived in the manner prescribed by the Governor of the Financial Supervisory Service, the details of bonds traded by a foreigner through an international depository and clearing organization that has completed the registration of investment in its own name.
Article 6-26. (Special Exceptions to Application)	(3) As to cases where a foreigner intends to acquire bonds issued in Korean won in Korea by a foreign corporation and sold overseas (including cases where a foreigner acquires the bonds in Korean won sold in Korea by such foreign corporations for retiring them after purchasing), Articles 6-10, 6-14, 6-15, and 6-21 shall not apply. (4) As to foreign exchange stabilization bonds issued in foreign currency in Korea by the Government, Articles 6-7, 6-10, 6-14, 6-15, and 6-21 shall not apply.

Source: Financial Services Commission. 18/01/2011. *Regulations on Financial Investment Business*.

¹⁸ This is based on Article 5-1(1) (i) of the *Detailed Rules of the Regulations on Financial Investment Business*. This shall refer to Euroclear and Clearstream.

d. Special Cases for Foreigner Registration

When registering an investment, one ID is issued per beneficiary owner. There are certain exceptions, however, to make investment more convenient for foreign investors. Overseas branches or business offices of a domestic investment dealer or investment broker can register separately when it is necessary to arrange the outsourcing of transactions in the securities market. A foreign financial institution can register separately under its own company name when it needs to manage its own assets and customers' assets separately.

An investment dealer or an investment broker can also separately file for registration of an investment under its own name when it is necessary to process entire orders for an investor group and distribute them. An investor group refers to a large number of foreign investors (foreign corporations only) whose investment management activities are managed by one and the same person under relevant laws or agreements.

A foreign investor group can make orders by using the same ID. Here, foreign investors eligible for making orders are those where the investment manager of the investor group has reported to the relevant investment dealer or investment broker before engaging in trading. Investment dealers and brokers have an obligation to make and keep a record of orders, order execution and order distribution.

Box 2.6 Regulations on Special Cases for Foreigner Investment Registration

- (1) Notwithstanding Article 6-10 (2), the registration of investment may be done additionally in the name of the relevant financial institution or similar in any of the following cases: Provided, that a statement shall be added to indicate that the registration is for the separate management of customers' assets in cases under subparagraph 2, or that the registration is for processing orders from an investor group in cases under subparagraph 3:
 1. Where it is necessary for an overseas branch office or an overseas business office of a domestic investment trader or broker or an investment trader or broker in Japan that are specified in subparagraph 1 of the notification with regard to the remittance of Japanese investors' fund for securities to make an arrangement for the entrustment of transactions in the securities market;
 2. Where it is necessary for a foreign financial institution or similar to manage assets for management separately by segregating its own assets from customers' assets; and
 3. Where it is necessary for an investment trader or broker to process orders from an investor group by consolidating the orders in accordance with Article 6-7 (3).
- (2) Any overseas depository that intends to acquire underlying stocks in order to issue depository receipts or secondary depository receipts shall file for registration of investment for each underlying stock of the depository receipts in addition to the registration of investment filed for the investment of its own assets, and in such cases the registered name shall include the class of the depository receipts and the name of the underlying stocks in addition to the name of the overseas depository.
- (3) Any foreigner who intends to acquire securities in accordance with Article 6-7 (1) 8 or 9 may file for the registration of investment for each issue of the securities, and in such cases the registered name shall include the name in which the securities were issued in addition to the name of the foreign depository.

Source: Financial Services Commission. 18/01/2011. *Regulations on Financial Investment Business*.

e. Registration Application Procedure

i. Summary

A foreign investor who wishes to register with the FSS in person or through a local agent may do so by submitting the completed registration application form (Form No. 34 of Supplementary Volume 1 of *Detailed Rules of the Regulations on Financial Investment Business*) to the FSS, along with the official documents that authenticate the lawful identity of the investor. After confirming all the documents, the FSS will

issue the IRC to the foreign investor directly or through a local agent. Table 2.5 shows the documents that authenticate the identity of a foreign investor.

Table 2.5 Official Documents that Authenticate the Lawful Identity of the Investor

For an individual investor	A passport or any other equivalent document issued by a foreign government stating the name, the date of birth and other personal information of the applicant may suffice. Notarization is required when submitting a copy. (Notarized letter of authorization is required when registering through a local agent.)
For a legal entity	A certificate of incorporation (COI) and other similar documents issued by a central government, local governments, or a public regulatory authority of a foreign nation stating the name of the entity, the date of incorporation, the name of the issuing authority and the date of the issuance may suffice. Notarization is required when submitting a copy. (Notarized letter of authorization is required when registering through a local agent.)

Source: Korea Financial Investment Association, Chapter 14 in *2010 Capital Market in Korea*.

Although separate registrations were required in the past for those investing in stocks and bonds, the registration system was improved to permit investing in stocks and bonds with a single IRC with the amendment to the *Regulations on Supervision of Securities Business* on 26 May 1998. However, investors that only have one registration certificate issued for stock investment prior to the amendment must register for bond investment separately if they wish to invest in bonds

The FSS has developed an electronic registration system for foreign investors to shorten the time required for investment registration, which has been in operation since 1 June 2007. Under the system, financial institutions (local agents of foreign investors) file investment registration applications and submit relevant documents through the Financial Information Exchange System (FINES) to the FSS, and receive registration certificates electronically.

ii. Detailed Procedures

Detailed discussions on for IRC through a local agent or in person can be found in “Capital Market in Korea.”¹⁹

1) Designating a Local Agent and Registering through the Agent

The local agent applies for the foreign investor’s IRC by electronically submitting the IRC application and relevant documents to the FSS through FINES (<http://fines.fss.or.kr/>). The FSS then reviews the documents. When approved, an IRC will be issued electronically (Figures 2.1 and 2.2 below for the detailed procedure for registration).

¹⁹ Footnote 1, p. 233–234.

Figure 2.1 Procedure for Applying for Foreign Investor Investment Registration Certificate through a Local Agent

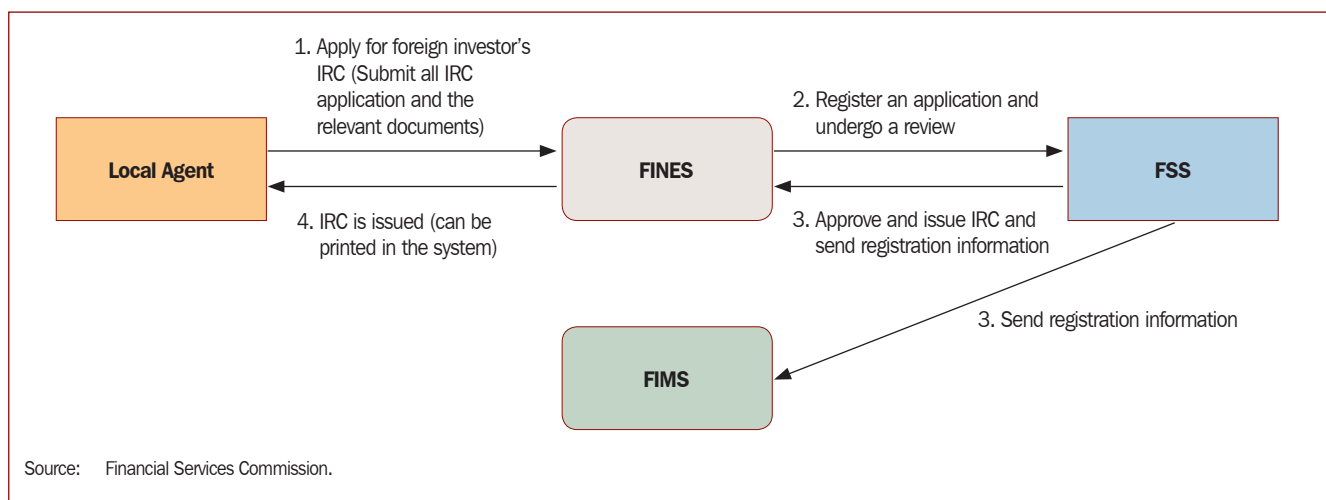

2) Registering in Person

Foreign investors can submit the IRC application and all official documents, authenticating their identities in person. The FSS will issue an IRC after confirming the documents.

Figure 2.2 Procedure for Applying for Foreign Investor Investment Registration Certificate in Person

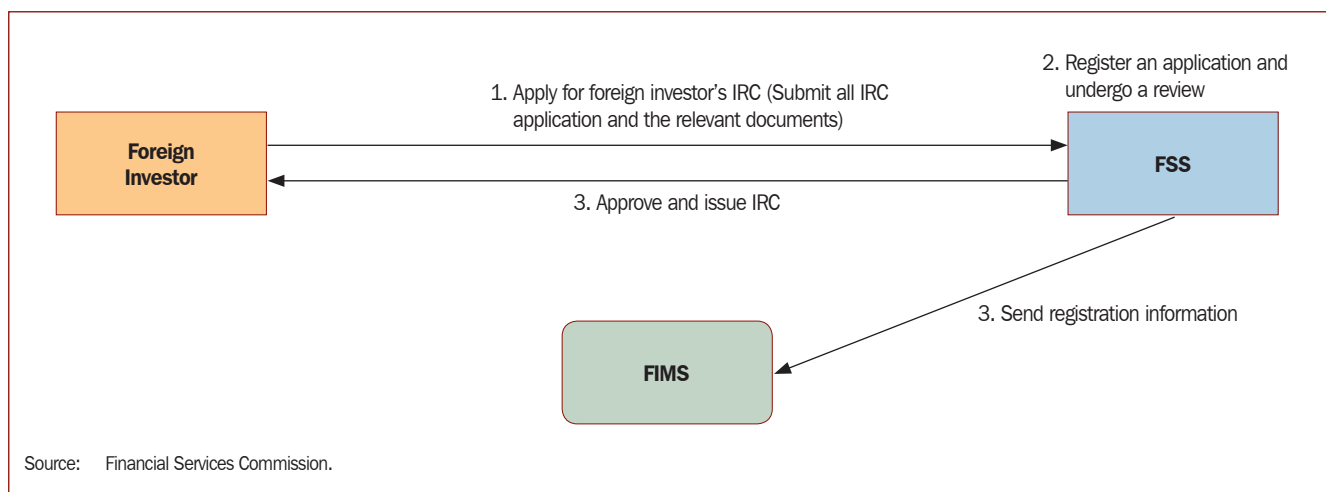

C. Taxation Framework and Tax Requirements

1. Tax on Financial Investment Instruments

a. Taxable Income

According to the *Income Tax Act (ITA)*, “interest and discount amounts” are considered taxable interest income.

Bonds are usually issued at par or at discount. Bonds issued at par pay interest on a quarterly or yearly basis to bondholders based on the coupon rate, considering the market interest rate at the point of issuance. Bonds issued at discount pay the principal and amount of interest simultaneously at the point of maturity. The term “discount amount” in this context means an amount of interest paid at the point of maturity of the bonds issued at discount. That amount shall be the difference between the amount of redemption at maturity and the value of bonds discounted by the market interest rate at the point of issuance.

The taxable discount amount stipulated in ITA only refers to issuance discount (the amount according to the market interest rate at the point of bond issuance), not the market discount (the amount according to the market interest rate at the point of early bond redemption). If a person redeems their bonds before maturity, they have to pay tax on the amount of interest accrued during possession of the bonds. For instance, if an investor who bought 3-year discount bonds with an amount of W3 million of discount wants to sell the bonds after only a year of possession, out of the total discount amount of W3 million, W1 million—the discount amount allocated for one year of possession—is the interest income liable for taxation. (This is referred to as the holding period tax system for bonds.)

Usually both the interest and discount amount of bonds are taxable, except when they are 1) government bonds; 2) industrial finance bonds; 3) deposit protection fund bonds and compensation fund bonds for deposit protection fund bonds; and 4) monetary stabilization bonds issued by the Bank of Korea on the open market. In these cases, to help promote and develop the government bond market, only the amount of interest accrued by the coupon rate exclusive of the discount amount is considered to be taxable interest income according to Subparagraph 2 of Art. 22-2 of Enforcement Decree of Income Tax Act. Furthermore, if a person transfers his/her bonds to another person before maturity, they could accrue capital gains due to the interest rate difference between the interest rate at the point of bond issuance and at the point of the transfer. But Korea’s taxation law do not levy tax on capital gains accrued from the transfer of bonds. When calculating taxable income, the amount of interest and dividend income shall be included in the total gross income accrued during the corresponding year according to Art. 16 (2) and Art. 17 (3) of ITA. Therefore, necessary expenses are not recognized as expenses.

b. Receipt Date of Income

The date of receipt of income from bond interest shall be the date of receipt of such payments for interest and discount amounts for bearer public bonds, and the payment date under the agreement for interest and discount amount in the case of non-bearer public bonds, according to Subparagraph 2 and 3 of Art. 45 of EDITA. The receipt income accrued from coupon interest shall be the date of coupon, which is the receipt date of such payment. As for the discount, the receipt date of income shall be the date of maturity, which is the receipt date of such payment.

In the case of the sale of bonds before maturity, the receipt date of income from interest shall be the sale date of the relevant bonds. Therefore, when discount bonds are sold before maturity, the receipt date of income from the sale of the relevant bonds shall be the sale date, and if the bonds were redeemed at maturity, the date of

redemption at maturity shall be the date of income from such payment according to Subparagraph 10 of Art. 45 of EDITA.

Meanwhile, in the case of commercial notes or cover notes with short maturity terms traded by the passbook in custody, the receipt date of income shall be the date of discount sale if the owner of the notes decides to pay withholding tax on the same day. (Such bonds are referred to as prepaid interest bonds).²⁰

²⁰ Footnote 1, p. 265–267.

III. Trading of Bonds and Trading Market Infrastructure

A. Over-the-Counter Trading of Bonds

The over-the-counter (OTC) market accounts for 80% of the Korean bond market. The Korea Exchange (KRX) market accounts for 20% of the Korean bond market.

Table 3.1 Proportion of Korea Exchange Bond Market (W trillion, %)

Year	BOND Market (Total)				KTB				KTB (Benchmark only)			
	KRX	OTC	Total	Market Share of KRX	KRX	OTC	Total	Market Share of KRX	KRX	OTC	Total	Market Share of KRX
2000	26.9	928.2	955.1	2.8%	21.6	251.3	273.0	7.9%	17.3	71.3	88.6	19.5%
2001	13.8	1,401.7	1,415.5	1.0%	10.1	443.1	453.2	2.2%	4.1	166.2	170.2	2.4%
2002	47.9	1,079.9	1,127.8	4.2%	42.6	343.2	385.8	11.0%	11.9	106.1	118.0	10.0%
2003	212.6	1,234.1	1,446.7	14.7%	207.9	453.9	661.9	31.4%	123.6	153.9	277.5	44.5%
2004	377.5	1,439.5	1,817.0	20.8%	358.4	707.8	1,066.2	33.6%	256.8	313.8	570.5	45.0%
2005	365.4	1,541.3	1,906.7	19.2%	337.7	729.3	1,067.0	31.6%	272.8	345.5	618.3	44.1%
2006	295.5	1,341.6	1,637.1	18.1%	267.4	660.1	927.5	28.8%	215.6	338.0	553.6	38.9%
2007	355.8	1,185.5	1,541.3	23.1%	316.7	570.5	887.2	35.7%	183.7	199.7	383.4	47.9%
2008	376.3	1,417.2	1,793.5	21.0%	321.2	603.0	924.3	34.8%	169.3	247.5	416.8	40.6%
2009	504.4	2,073.6	2,578.0	19.6%	427.1	1,057.2	1,484.3	28.8%	225.2	544.4	769.6	29.3%
2010	584.2	2,785.8	3,370.0	17.3%	413.7	1,542.8	1,956.5	21.1%	312.3	673.7	986.0	31.7%
2011	350.1	1,407.2	1,703.4	20.2%	330.1	742.5	1,072.0	30.8%	306.0	346.5	052.0	48.9%
Jan	53.6	226.7	280.3	19.1%	49.1	110.2	159.3	30.8%	43.8	38.9	82.6	53.0%
Feb	44.5	188.1	232.6	19.1%	41.4	95.4	136.8	30.3%	38.0	51.7	89.7	42.3%
Mar	60.4	261.7	322.2	18.8%	55.8	139.8	195.6	28.5%	51.0	84.0	115.0	44.3%
Apr	51.6	223.9	275.5	18.7%	47.5	121.0	168.6	28.2%	44.1	56.7	100.8	43.7%
May	66.3	231.9	298.2	22.2%	61.7	117.6	179.3	34.4%	58.69	65.3	124.0	47.3%
Jun	79.70	274.88	354.6	22.5%	74.55	158.46	233.0	32.0%	70.52	69.95	140.5	50.2%

Source: Korea Exchange.

Before the Korean government made it mandatory for primary dealers (PD) to deal in the exchange market to develop the Korea Treasury bond (KTB) market (in October 2002), the OTC market accounted for 98-99% of all bond trading. The

main participants in the OTC bond market are institutional investors, including banks, asset management companies, pension fund managers, and insurance companies. Institutional investors trade bonds through financial investment firms that serve as brokers. In other words, each institutional investor presents an ask and a bid price to the financial investment firms they trade with, and the investment firm matches the ask price and bid price to establish a deal. The investment firms, which serve as brokers, exchange offers and bid prices among themselves, thereby facilitating trading. In other words, financial investment firms are central to facilitating bond trading in the OTC market among institutional investors.

The Korea Financial Investment Association (KOFIA) introduced the OTC Bond Quotation System (BQS) in collaboration with the Financial Supervisory Commission (FSC). BQS was introduced to increase transparency in the OTC bond market.

Figure 3.1 Structure of the Bond Over-the-Counter Market

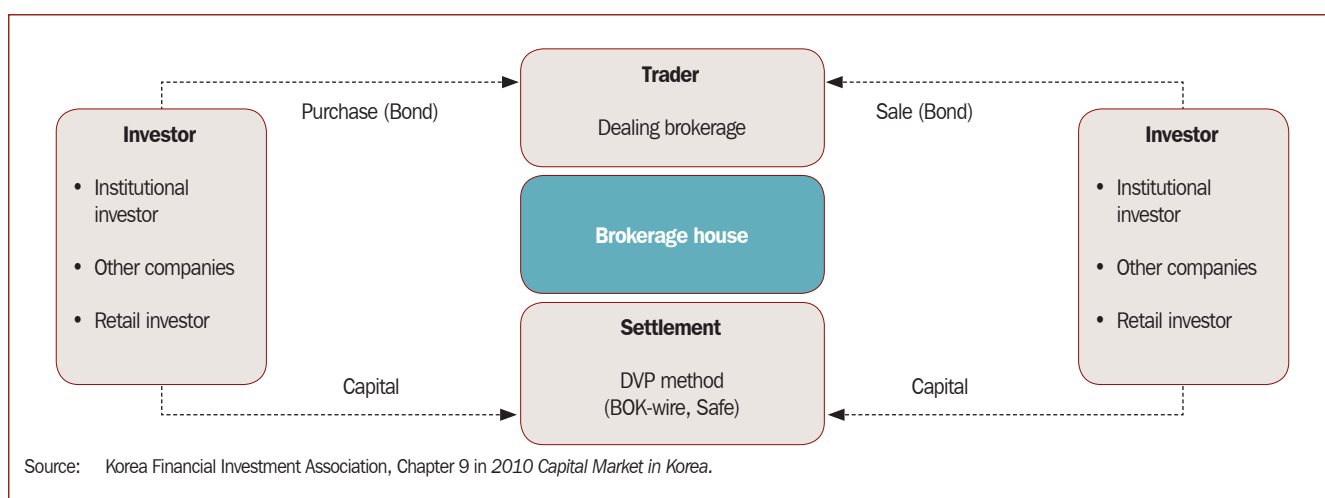

B. Exchange Trading of Bonds

a. Ordinary Bond Trading System

i. Bonds Eligible for Trading

All bonds listed on the KRX, such as government bonds, municipal bonds, specific laws bonds, convertible bonds (CB), bonds with warrants (BW), exchangeable bonds (EB), corporate bonds, etc. are eligible for trading.

ii. Trading Hours

Trading hours are from 9:00 a.m. to 3:00 p.m. every day except holidays and Saturday.

iii. Offer Price

Price quotations are accepted and the time for receiving quotation is from 8:00 a.m. to 3:00 p.m. Quotation price, quotation quantity, and trading units are classified in Table 3.2 as per equity-linked bond, general bond, and foreign currency bond. There is no price change limit.

Table 3.2 Classification of Quotation Price, Quantity, and Trading Units

Classification	Equity-linked bond	General Bond	Foreign currency bond
Quotation price unit	W1	W1	1 point
Quotation quantity unit	Face value W10,000	Face value W10,000	10,000 point
Trading unit	Amount of bond note (min. face value W100,000)	Face value W100,000 (small-lot/retail bond: W1,000)	10,000 point
Source: Korea Exchange. http://eng.krx.co.kr			

iv. Price Determination in Individual Competitive Auction with Single Price (Simultaneous Offer Trading)

Under this system all the quotations, received in a certain span of time, are deemed to have been received at the same time, and the trading is made in single price which shall then be applied to initial price determination, or the same occurring after resumption of either the market or trading (applying quotations received 10 minutes since resumption).

- (1) In the above case, the trade shall be executed between the matched quotations as follows:
 - (a) The total quantity of offers with the price lower than the matched price and the total quantity of bids with the price higher than the matched price.
 - (b) With regard to bids and offers at the matched price, the quantity are mentioned below:
 - (i) total quantity of either bid or offer quotations at the matched price; and
 - (ii) among the quantities of quotations on the counter side, the quantity above the trading unit of the issue concerned.
- (2) Priority of simultaneous quotation is as follows
 - (a) Price priority
 - (b) In case of same price range, the quotations for customer account transactions have priority over the quotations for proprietary account transactions
 - (c) Quantity priority per quotation
 - (d) The order of quantity allocation (10 times of trading unit → 100 times → 1000 times → half of the residual → the total residual quantity)

v. Price Determination in Multiple Price Auction (Continuous Auction)

In case the lowest offer price matches the highest bid price among the competitive bids and offers, trading shall be made at the price of quotation received first, and trades between the matching bids and offers are executed according to the priority of quotations (priorities in price and time).

vi. Reported Trading System

When the members request the KRX to execute a trade between the bid and offer quotations of which the issue of debt security, price and quantity are the same, the KRX execute such trade at such price and quantity.

To input a report in the KRX's system through the member's system, the KRX executes the reported trading between corresponding quotations and at the same time it considers settlement is finished.

vii. Settlement

Table 3.3 Description of Settlement Process

Item	Descriptions
Kind of trading	Applicable only to the same day settlement (T+0) trading
Settlement between investors and securities company	
Time limit of settlement	By 3:30 p.m. of settlement date In case of registered bond, registration notice or registration certificate shall replace the sold bonds, and required documents for the change of registration shall be attached.
Collection of commission for customer account trading	If trading is made through entrustment of selling or buying from an investor, a member company shall collect commission according to the rates reported to the Korea Exchange.
Settlement by a member	
Time limit of settlement	By 4:00 p.m. of settlement date
Settlement method	A member has to make a payment to settlement agency prior to time limit after netting. Settlement of foreign currency bond shall be made in Korean won converted by basic rate on the settlement date according to <i>Foreign Exchange Control Regulation</i>
Settlement by Securities Delivery Bill	If it is impossible to deliver the traded bonds due to defective bonds, selling small-lot bond, foreigner's selling or selling bonds with low liquidity, the securities delivery may be replaced by Securities Delivery Bill issued by the Korea Exchange.
Source: Korea Exchange. http://eng.krx.co.kr	

b. Small-Lot Public Bond Trading System

i. Small-Lot Bond Standard

Small-lot bond means the one issued in that month and in the previous month based on trading date with an amount of less than W50 million at face value per account (per person in case of common account).

ii. Applicable bonds

- (1) Type-I National Housing Bonds
- (2) Seoul Subway Debentures and Seoul regional development debentures
- (3) Public bond for community development issued by special city, metropolitan cities and provinces according to the *Regional Public Enterprise Act*
- (4) Provincial subway debentures (Busan, Daegu, Daejeon, Kwangju, and Incheon)

iii. Market Concentration Trading System of Small-Lot Bond

Market concentration trading system of small-lot bond was introduced for the purpose of improving convenience of buyers of the “add-on” fractional bonds and mitigating personal burden by raising easier exchange of bonds to be bought by persons at the time of registration of real-estate or automobile. Taking into consideration liquidity of bonds, eligible bonds in this system are the bonds having been issued in that month or in the preceding month, and the quotation of trading is less than W50 million per account (or per person in case of common account).

(1) Report of Small-Lot Bond Self-Trading

In spite of the above system, if trading price of small-lot bond is above market price or made after trading hours, it is possible to have self-trading, with limitation to the trading with settlement in that day, outside of market on the basis of reported market yield. In this case the member is liable to report to the KRX the trading hour, name of issue, quantity and price (yield).

(2) Exclusive Member for Buying Small-Lot Bond

In order to have smooth trading the KRX nominates, among member companies, exclusive members for buying small-lot bond who submit compulsory bids, which is being run with 20 firms as of March 2010.

(3) Reported Market Price System

Reported market yield means the one calculated by the KRX; arithmetic average price disregarding high price of 10% and low price of 20%. The KRX calculates the said ratio when an exclusive member company reports a desired price for the purchase to enhance easier exchange by persons who are to compulsorily purchase the “add-on” fractional bonds and to promote consumption of bonds based on market fair price. Reported market price is applied to trading at the time of market closing of the next day so that a person can dispose the public bonds they owned at this price.

iv. Trading Rules Applicable to Small-Lot Bond.

Table 3.4 shows the trading rules especially applicable to small-lot bond.

Table 3.4 Trading Rules for Small-Lot Bond

Item	Descriptions
Common account for small-lot bond only	One-time trading for the “add-on” fractional bonds by an individual is possible through common account only for small-lot bond under the name of a member without opening a separate account.
Bid price per kind of bond	Seoul subway debentures, Seoul regional development debentures, and provincial subway debentures shall be classified into categories per same issuance date, and their bid prices are submitted as one group
Trading unit	Face value W 1,000
Priority of simultaneous quotation	W10 million → W50 million → W300 million → W500 million → the residual
Trading at market closing	Single price by reported market price of previous day shall be applied to trading from 20 minutes prior to closing till market closing

Source: Korea Exchange. <http://eng.krx.co.kr>

c. Primary Dealer Trading System**i. Bonds Eligible for Trading**

Government bonds are traded exclusively in the special market. Applicable bonds are Korea treasury bonds (KTBs), monetary stabilization bonds, and Korea Deposit Insurance Corporation (KDIC) bonds. The details of the bonds eligible for trading in the special market are shown in Table 3.5.

Table 3.5 Bonds Eligible for Trading in the Special Market

Item	Details
Benchmark KTBS	The most recently issued (on-the-run) KTBS in their respective maturity ranges. Primary dealers are required to perform market making for the benchmark KTBS.
Non-benchmark KTBS	KTBS other than the benchmark issue (off-the-run issues)
Monetary stabilization bonds	The most recent two MSB issues whose outstanding amounts are W200 billion or more (among 1-year and 2-year maturity of MSBs)
KDIC bond	The most recent two 5-year KDIC bonds issues whose issuance amounts are W200 billion or more.

KTBS = Korea Treasury bonds; MSB = monetary stabilization bonds; KDIC = Korea Deposit Insurance Corporation
Source: Korea Exchange. <http://eng.krx.co.kr>

ii. Trading Hours and Quotation Price

(1) Trading Hours

Trading hours are from 9:00 a.m. to 3:00 p.m. for specialized market of government bonds. Holidays are public holidays, Labor Day, Saturday, 1 day at the end of the year, and other necessary days designated by the KRX.

(2) Quotation

Price-based limit quotation is used in this market. The quotation tick-size is W1; quotation quantity unit is face value W10,000 and trading unit is W1 billion.

(3) Kinds of Quotation

Quotation is divided into market-making quote and trading quote. The former is further divided into a two-way market-making quote and one-way market-making quote. A two-way market-making quote is the one that a primary dealer or a preliminary primary dealer submits as buying and selling quote simultaneously while one-way market-making quote is the one that a bond dealer (general dealer) submits as selling or buying quote.

Trading quote means a one-way quote that a participant submits to trade with market-making quote. In case of customer account trading, only one-way market-making quote and trading quote are available

iii. Trading Execution and Settlement

The specialized market of government bonds adopts a full automatic trading system based on the Internet-order environment of the KRX Trading System (KTS) for government securities in accordance with the individual competitive trading principle of multiple prices (simultaneous quotation not available).

Multilateral netting settlement and collective settlement are applied thereto so that in spite of innumerable trading by participants, it is possible for the KRX to minimize quantities of settlement bonds and the needed money. At present, payment adopts the fund-transfer method through Bank of Korea (BOK)-Wire while settlement of government bonds adopts transfer method between deposit accounts at the Korea Securities Depository (KSD).

Settlement period is T+1 (or T+2 for trading on the preceding day of reserves day) and time limit is 4:00 p.m. of the settlement day.

(1) Trading Execution and Settlement (Summary)

- (a) Method of Trading Execution
 - (i) Full automatic trading method using Internet-order environment and individual competitive trading principle of multiple prices (simultaneous quotation not available) to be applied
 - (ii) Settlement method: Multilateral netting settlement and collective settlement
 - (iii) Payment: Fund transfer method through BOK-Wire
 - (iv) Settlement of government bonds: Transfer method between deposit accounts at KSD

- (b) Settlement Period and Time Limit
 - (i) Settlement period: T+1 (or T+2 for trading on the preceding day of reserves day)
 - (ii) Time limit: 4:00 p.m. of the settlement day

iv. Participants in Government Bonds Market

Participants in the government bonds market include:

- (1) Government bond dealers such as (i) securities companies and (ii) banks which, have obtained the permit from the government and are the members of the KRX; and
- (2) Ordinary institutional investors, such as (i) pension funds, (ii) insurance companies, and (iii) asset management companies.

Depending on their functions, government bond dealers are categorized into primary dealer (“PD”) and the ordinary dealer (“dealer”).

PDs have rights to directly participate in the underwriting of KTBs in the primary market, but are required to act as market maker in the KTS of the KRX. Dealers are able to participate in the KTS of the KRX, but are not allowed to directly underwrite KTBs in the primary market. There are 20 PD companies as of the end of December 2010.

v. Primary Dealer System

Primary dealer is rendered benefit such as preferential bidding opportunity in the issuance market of government bonds, bidding on behalf of non-competition bidding participants, takeover of government bonds and financial support. Meanwhile, the PD is a market maker who takes over more than 5% of total government bonds issued and performs market-making duties in specialized market for government bonds.

A Preliminary Primary Dealers (PPD) shall be nominated as a PD 1 year after its appointment as PPD by the Minister of Strategy and Finance if the agency submits application for PD, and satisfies the following requirements (Table 3.6):

Table 3.6 Requirements for Appointment as PPD

Item	Details
Financial soundness	Securities firm: net capital ratio for business \geq 350% Bank, merchant bank: BIS net worth ratio \geq 10.0%
Dealing manpower	More than five persons with more than 3 years experience
Research manpower	More than three persons with more than 3 years experience
Back-office manpower	More than four persons with more than 1 year experience
Business period of government bonds dealing	More than 2 years from permission date for government bond dealer to the application date for PPD

BIS = Bond Institutional Settlement; PPD = Preliminary Primary Dealer
Source: Korea Exchange. <http://eng.krx.co.kr>

C. Bond Repurchase Market

1. The Repurchase (Repo) Market

Figure 3.2 illustrates the repo trading mechanism.

Figure 3.2 Repo Trading Mechanism

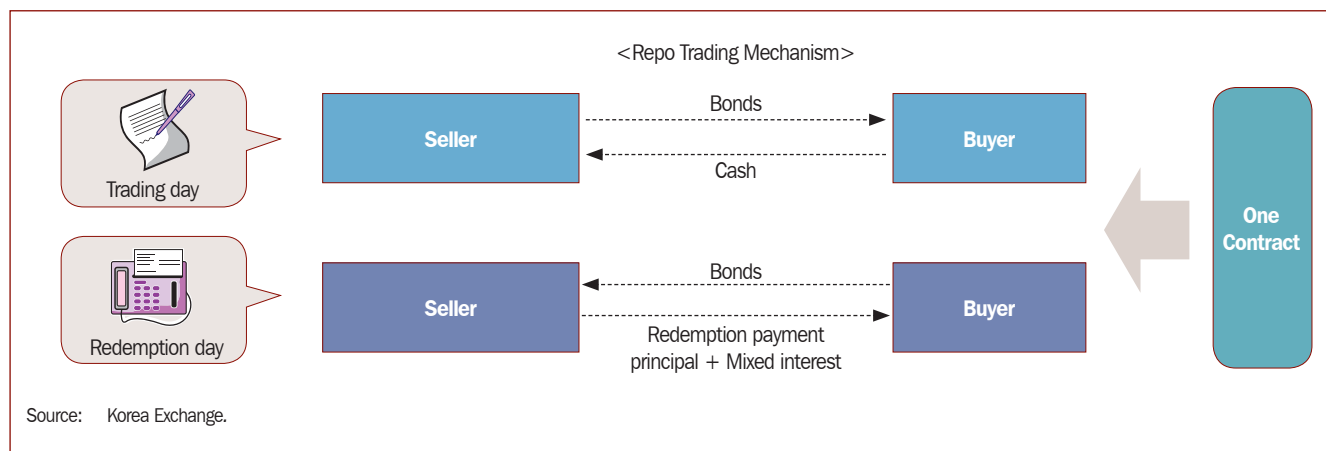

Besides bonds, stocks and real estate property may be used as an underlying asset for repurchase agreement. However, repo traditionally refers to a short-term loan transaction using bonds as collateral and the repo market is closely related to the bond market. Because the repo transaction uses bonds as underlying asset, it not only influences the supply and demand in the bond market, but also offers the opportunity to profit from the price difference between the repo and bond, which helps the process of price discovery. Thus, the repo market plays as bridge between the short-term money market and capital market.

2. Korea Exchange Repo Trading System

a. Bonds Eligible for Trading

Securities which can be transacted by repo are bonds, stocks, commercial paper (CP), Certificate of Deposit (CD) and monetary stabilization bond (MSB). However, transaction with repo at the KRX market is limited only to certain bonds listed in Table 3.7. The reason is to secure stability of repo transactions through restriction of the objects to the ones with low risk, high liquidity, diversified investor base, and stable cash flow. Accordingly, excluded from repo transactions are such bonds as redemption-by-installment bond, floating rate note except Korea Treasury bond, equity-related bond, mortgage bond, privately-offered bond, subordinate bond, asset-backed bond, etc. In other words, tradable securities in the KRX repo market are government bonds (Treasury bond, foreign-exchange stabilization bond), specific laws bond (MSBs, KDIC bond) and blue-chip company bond (credit rating over AAA) that satisfy aforementioned requirements.

Table 3.7 Bonds Eligible for Trading at the Repo Market

Classification	Applicable Items	Requirements
Government bonds	Treasury bonds Foreign exchange stabilization bond	More than W200 billion of outstanding amount
Specific law bonds	Monetary stabilization bonds KDIC bonds	Vanilla bond
Corporate bonds	Unsecured debentures issued by companies in KOSPI stock market Guaranteed bonds	Above requirements + bonds of issuer and guarantee agency with credit rating over AAA
<small>KDIC = Korea Deposit Insurance Corporation; KOSPI = Korea Composite Stock Price Index Source: Korea Exchange. http://eng.krx.co.kr</small>		

Among bonds with outstanding amount of at least KRW 200 billion as of the trading day, only KTBs, Korea International Bond, monetary stabilization bond, bonds issued by the KDIC and corporate bonds with credit rating AAA or higher are eligible for repo trade. The reason for specifying the bonds, eligible for repo trade is to ensure the reliability of repo trade by limiting the eligibility to those bonds with low risk, high liquidity and diversified investors base (outstanding balance of at least W200 billion). Even if the bonds meet the requirements noted above, if the yield of bond displays an erratic pattern of a possibility that the bond would be redeemed early or converted into another security, such bond is not eligible for repo trade. Thus, only plain vanilla bonds with no conditions attached are eligible for repo trade.

b. Kinds of Trading Period

The main reason why a bond dealer uses the repo market is to resolve the temporary shortage of fund and the excess or shortage of securities, which may arise during market making in the cash market; hence, most of repo term is less than 1 year.

There are 10 types of Repo term, i.e., overnight, 2 days, 3 days, 4 days, 7 days, 14 days, 21 days, 30 days, 60 days, and 90 days. The repurchase date for each repo term is the 2nd day, 3rd day, 4th day, 5th day, 8th day, 15th day, 22nd day, 31st day, 61st day, and 91st day, respectively, counting from the day on which the purchase price is settled (in case the repurchase date is a market holiday, it is postponed the next business day).

Most markets of advanced countries generally adopt term repo which specifies trading period at the contract date of repo, and most of the periods are within 1 month.

The term repo is applied to the KRX repo market following international tendency and eight terms (1-day, 2-day, 3-day, 4-day, 7-day, 14-day, 21-day and 30-day). Having less than 1 month trading period with abundant liquidity, 60-day and 90-day repo are available.

c. Trading (Submission of Quotation) Hours

Quotation receiving and trading time at the repo market of the KRX is from 9:00 a.m. to 3:00 p.m. and is the same as that of KTS.

d. Quotation Price

According to the characteristic of repo trading, repo rate is applied to quotation in the repo market and is quoted in yield terms, to two decimal places. Quotation quantity unit and trading unit are W10,000 and W5 billion, respectively. Only designated quotations are applicable in the case of repo selling, while both designated quotations (a kind of special collateral quotations) and non-designated quotations (a kind of general collateral quotations) are accepted in repo buying. Participants in the market places orders with the KRX through a web browser installed in their own personal computer.

e. Participants in Repo Market

No restriction is imposed on participation in the repo market for repo trading made OTC because it is made through a broker or directly between parties concerned. Those who are entitled to participate in the KRX repo market are same as direct participants of KRX trading system for government securities to effectively support dealer financing and promote link trading like arbitrage trading between markets. That is, only securities members and bond specialist members (banks) of KRX can participate in the market. To participate in the repo market, every participant has to follow these procedures: permission of trading on bonds (from the Financial Service Commission) → acquisition of membership in the KRX → submission of agreement of repo trading to the KRX → registration as participant → acquisition of electronic authentication. In addition, the government has also participated in the market since 2 June 2003 in accordance with introduction of the repo trading system for KTB.

f. Trade Execution in the Repo Market

i. Trade Execution

The OTC market is accompanied by time and cost resulting from observation of quotation due to non-concentration of quotation information. To improve such problem, the KRX repo market adopts, as a standardized intra-market trading, an individual competitive trading (perfect competition trading) with multiple prices which aims to secure smooth contract trading and transparency of trading through concentration of quotations (only principle of price over time priority is applied without individual competitive trading with single price.). Namely, quotations submitted by participants are collected from the screen of the repo trading system at the KRX as per price range and in the order of submission, and then trade execution is made according to perfect competition trading method by multiple prices. Furthermore, designated buying quotations in the quotation book (refer to terminology of intra repo market) shall compete in selling quotations for the same item, and non-designated buying quotations are able to compete all kinds of selling quotations.

Trading shall be realized at repo rate of the preceding quotation if there is an agreement between selling quotation at the highest repo rate and buying quotation at the lowest repo rate. Generally speaking, contract price (or repo rate) in the repo market has a tendency to be formed higher than rediscount rate of the BOK but lower than interest of unsecured short-term financial market (call rate). Start leg price is not changed for the period until repurchase date in spite of substitution or exchange of bonds (fixed repo rate).

ii. Money for Trading

As per money to be paid by buyer to seller in consideration of trading bonds according to the contract, it is calculated through applying haircut to the market value of the bonds. The money for trading mentioned here is a fund to be lent by a buyer to a seller and it shall be the calculation basis of repurchase interest. The seller shall pay the same money back with repurchase interest to buyer on repurchase date.

In case of repo trading at the KRX, the market value of the object bond shall be calculated on the basis of the price of a fair evaluation agency, and a buyer of repo (lender of money) is required to hold excess security according to haircut. The formula for such is:

$$\text{Trading amount} = \text{trading bonds (total face value)} \times \text{market value}/100 \div \text{Haircut},$$

where the market value is the value calculated on the basis of bond par value W10,000. This means the simple arithmetic average of evaluation value which is the result of re-calculation, with due regard to transition period until the application day, of yield of the said bond to be announced by the market-value evaluation agency for evaluation of trading bonds and margin bonds. Haircut is the discount rate for taking risk of price fluctuation during repo transaction period, and it means the ratio to be claimed by a buyer to a seller and has a function of initial margin.

g. Closing of Trading

i. Settlement in the Repo Market

As a clearing agency for securities based on the *Financial Investment Service and Capital Market Act* (FSCMA), the KRX guarantees performance of settlement in relation to repo transactions. Therefore, it plays the role of CCP (Central Counter Party) of seller and buyer, respectively, as far as settlement is concerned. Additionally, it provides each concerned party with buy-back service for agreement of non-repurchase since the execution of repo trading (tri-party Agent). Therefore, participants may participate in the repo market free from worry about settlement default.

Table 3.8 Settlement in the Repo Market

Item	Descriptions
Settlement and repurchase agency	KRX (settlement guarantee)
The KRX (settlement guarantee)	Settlement by netting after unifying trading repurchase and additional deposit on that day
Settlement method	Cash payment: transfer through BOK-Wire based on data calculated/informed by the KRX Securities delivery: transfer through Safe System of KSD based on data calculated/informed by the KRX
Time limit settlement (on that day)	Trading on that day: trading day 4:00 p.m. Repurchase on that day: repurchase date 4:00 p.m. Additional deposit: accrual day of deposit 4:00 p.m.
BOK = Bank of Korea; KRX = Korea Exchange; KSD = Korea Securities Depository Source: Korea Exchange, http://eng.krx.co.kr .	

ii. Return of Dividend

If dividend occurs from trading bonds during the repo trading period, the buyer should pay back the pertinent dividend to the seller according to the contract. Time of payback is the day of accrual in case of classic repo adopted by the KRX. On the other hand, the buyer returns it after deduction from repurchase amount in case of sell/buyback. Meanwhile, in most advanced countries, withholding tax is not levied on financial income. Therefore, their procedures of dividend return are simple. However, the procedures in Korea, which maintains withholding system on financial income, are rather complicated in the case of repo trading, which results in restriction of trading.

iii. Marking to Market

Marking to market means a series of procedures to maintain value of securities on a proper level through collecting additional deposit after calculating disclosed risk of one or the other party's all agreement of non-repurchase with the same party in preparation of price fluctuation of trading bonds per trading day to guarantee settlement performance of repo trading.

In marking to market, there are such methods as direct execution between parties, one acted by a tri-party agent and the other executed by a CCP of an international trend. In the case of repo trading at the KRX, the KRX shall play the role of a CCP for both parties and shall be responsible, as a repurchase agency, for doing marking to market and collecting additional deposit when disclosed to risk.

vi. Repurchase Amount

The repurchase amount is the money to be paid to a buyer by a seller according to trading agreement and is calculated as follows:

$$\text{Repurchase amount} = \text{Trading amount} \times (1 + \text{repo rate} \times \text{Repo transaction period}/365)$$

h. Settlement by Cash

It might happen that a person, who is to pay back trading bonds or maintenance margin security on repurchase date, meets an uncontrollable situation being unable to secure bonds due to lack of liquidity of object bonds in spite of his sufficient financial ability to pay. As such it might be difficult for some dealers to make bonds settlement and the adverse effect of such settlement default might spread if the situation is left without any measures. Thus, to prevent such situation, the KRX has a system of settlement by cash in place of settlement by bonds under the condition of imposing adequate penalty subject to agreement of both seller and buyer. The rate of penalty depends on the premium required for re-buying the corresponding bonds by the other party, and other market situations.

i. Settlement at the Repo Market

Repo trading shall expire if the repurchase date arrives. The contract expires on the repurchase date in case of normal arrival of expiration. However, if any of the following causes occur either on trading bonds or on a party, then the date of the occurrence shall be the repurchase date for stabilization of repo transactions, and the contract shall be terminated earlier than the original date. In cases of normal arrival

of repurchase date and the repo seller's refusal of exchange, the contract shall expire through exchanging trading bonds and repurchase amount.

In case of settlement default by a party, however, all the contracts between the parties shall be able to be settled by cash. As in the case of repo trading at the KRX, the KRX as CCP shall pay instead the shortage money resulting from the settlement of cash and file a claim against the defaulting party to get appropriate compensation.

Table 3.9 Settlement at the REPO Market

Item		Descriptions
Normal repurchase		Arrival of repurchases date
Early repurchase	Finalization per trading	Refusal of exchange by a seller Delisting of trading bonds Earlier refund of principal and interest of trading bonds
	Finalization of all agreements of non-repurchase (finalization as Single Agreement)	Settlement default by seller or buyer (including additional deposit) Suspension or ban from trading with banks due to dishonor of bill or check/suspension of business/bankruptcy, dissolution, application of rehabilitation or commencing de-facto rehabilitation according to laws
Source: Korea Exchange, http://eng.krx.co.kr		

j. Trading/Settlement System

i. Korea Exchange Repo Trading System (Summary)

Table 3.10 KRX Repo Trading System

Items	Systems
Type of REPO trading	- Term REPO - Classic REPO
Market participant	a security's member of the KRX (including bond specialist member)
Counter trading party	the KRX (anonymous trading)
Eligible bonds for	- government bonds (treasury bond, foreign, exchange stabilization bond) - specific laws bond (monetary stabilization bonds, KDIC bond) - corporate bond (credit rating over AAA) * as of the trading day, total par value of unredeemed bonds should be more than W200 billion
Trading unit	KRW5 billion (par value basis)
Market value	value calculated by the KRX based on evaluation values of 3 bond pricing agencies nominated by the head of FSC (simple arithmetic average price)
Trading amount	market value of trading bond/[haircut (2%) + 1]
repo rate	Annual interest rate that the seller agreed to pay at the time of repurchase
Repo terms and repurchase date	1 day (Overnight), 3-day, 7-day, 14-day, 21-day, 30-day, 60-day, 90-day (8 Repo terms)
Trading (offering) hours	09:00 a.m. to 3:00 p.m.
Trading method	individual competition trading with multiple prices (price/time priority) (no auction at single price)
Realization of trading	when there is a match between bid and asked

continued on next page

Table 3.10 continuation

Items	Systems
Kinds of offer	- ask: only designated quotation is accepted - bid: designated/non-designated are accepted * designated: designation of a specific item * non-designated: non-designation of a specific item
Quotation unit	0.01%
Price limit	not applicable * safety device for prevention of offer input by mistake (dealer's terminal/trading system)
Source: Korea Exchange. http://eng.krx.co.kr	

ii. Korea Exchange Repo Settlement System (Summary)

Table 3.11 KRX Repo Settlement System

Items	Systems
Repurchase agency	KRX
Settlement obligation	KRX
Settlement method	- cash payment: transfer in-between BOK reserves accounts (BOK-Wire) - securities delivery: account transfer on depositor's account (KSD Safe)
Time limit to settle	- trading portion: by 4:00 p.m. of trading day - repurchase portion: by 4:00 p.m. of repurchase day - deposit money/dividend: by 4:00 p.m. of accrual day
repurchase amount	trading amount \times (1 + repo rate \times contract term/365)
Return of dividend (including transfer pay)	return of interest accrued from trading bond/maintenance margin bond
Marking to market	- settlement method: evaluation of whole quantities considering all the contracts as single contract per counterpart - Margin Call: when requested amount for settlement exceeds exemption rate
Type of deposit	- haircut (initial deposit): the amount to be borne by a seller due to discount of market value of trading bonds at initial trading contract - additional deposit: deposit to be paid according to Margin Call of the KRX
Payment of deposit	- type: cash/bonds - payment: report by 1:00 p.m./payment by 4:00 p.m.
Substitution of bonds	- reason: request by seller (only for non-designated buying, it is allowed once per contract) - available period: next day of trading settlement - one day prior to repurchase - application/response: by 1:00 p.m./2:00 p.m. - substitute bonds: bonds having more than evaluation value of trading bond before substitution (1 item among same category)
Exchange of bonds	- reason: request by buyer due to dishonor of issuer of trading bonds - available period: next day of trading settlement - one day prior to repurchase day - application/response: by 1:00 p.m./by 2:00 p.m. (earlier repurchase in case of refusal) - exchangeable bonds: bonds having more than evaluation value of trading bond (1 item among same category)
Earlier repurchase	- reason: settlement default of a party to contract, etc. - settlement method: securities or cash
Source: Korea Exchange. http://eng.krx.co.kr	

k. Accounting Procedures under the Repo System

i. Repo Trading Day

The repo seller shall deliver bonds, fill trading amount received from buyer in the account of 'selling of repo bonds' of short-term debt account, and re-assort collateral transferred to buyer from commodity (investment) bonds to 'repo bonds'.

The repo buyer shall receive bonds, fill money paid to seller in the account 'buying of repo bonds' of short-term lending, and deal secured debt provided by seller with notes.

ii. Spot Trading of Repo Buying Bonds

The seller, who sells secured bonds at spot market (spot selling) after buying repo, shall be responsible to buy the bonds at spot market and to return them so that restoration shall be recorded as 'financial liability'. The seller shall offset substitutive payment and financial liability when effecting substitutive payment of interest. When repurchasing bonds (spot), the seller shall debit financial liability, and shall compare preceding evaluation value with buying price of bonds to reflect profit and loss on 'evaluated profit and loss of repo trading'.

Following spot trading of buying bonds, the seller is liable to make voluntary payment of withholding tax for interest accrued during spot trading period, and thus, he shall enter the amount into 'tax on interest income' account, and then debit at the time of paying it to tax office.

iii. Expiration of Repo

Accounting procedures at the time of expiration of repo trading are divided into three kinds as follows:

Table 3.12 Expiration of Repo

Kind of Expiration of Repo Trading	Accounting Procedures
Normal expiration or early repurchase by refusal of exchange	Seller/buyer offset trading amount and repo buying/selling account and appropriate the refunded interest for payment/income commission account
Cash settlement or early repurchase by settlement default	Seller/buyer deal repo trading bond based on spot selling/buying
Early repurchase by early refund	Seller deals repo trading bond based on spot selling and buyer appropriates cash by early refund for debt account and offset in case of repurchase

Source: Korea Exchange, <http://eng.krx.co.kr>

3. Over-the-Counter Institutional Repo Market

i. Repo Market in Korea

The repo markets in Republic of Korea consist of 1) the institutional repo market where repo trading occurs mainly for the purpose of financing and operating funds between financial institutions, 2) the customer repo market where financial institutions trade with non-financial corporations or individuals in terms of received deposits, and 3) the BOK repo market where the central bank, as a part of its open market operation, trades with financial institutions in order to manage the money supply and interest rates.

Most financial institutions can participate in the OTC institutional repo market, whereas only financial institutions who are the members of the KRX are allowed to trade in the KRX repo market.

ii. Direct Trade versus Brokered Trade

Repo trades in the OTC institutional repo market are divided into direct trades and brokered trades. Under direct trades, the participants themselves look for their counterparties. If they have a difficulty finding a counterparty, they may request a brokerage company to find one for them. A brokerage company serves as a bridge between compatible participants based on their trading conditions. There are four brokerage companies in the OTC institutional repo market. According to the trade volume as of 30 June 2011, the percentage of brokered trades is approximately 75%.

iii. Tri-Party Repo Agent

A tri-party repo agent is an independent third party that provides services, including settlement and collateral management services after repo trades are executed. The KSD acts as a tri-party repo agent that provides participants with the aforementioned services to facilitate repo trades in the OTC institutional repo market from their initial execution to their repurchase date.

iv. Participants

The regulations for financial investments prescribe that financial institutions are eligible as participants in the OTC institutional repo market. Any participant who opens a securities ledger in the KSD and receives approval from the KSD can participate in the KSD's repo system. The KSD regulates that foreign participants must appoint a standing proxy for their repo transactions.

v. Eligible Securities

Securities that are allowed to be traded in the OTC institutional repo market are those prescribed in the FSCMA. Bonds, CPs, exchange-traded funds (ETFs) and equities are eligible for the KSD's repo system as long as these securities are deposit-eligible, subject for evaluation, and denominated in Korean won. Equities have been eligible for repo since October 2011.

vi. Types of Transactions

A participant normally designates a repurchase date at the time of concluding a repurchase agreement. This type of transaction is a fixed-term repo. On the other hand, an open-ended repo has no designated repurchase date. In the OTC institutional repo market, both types of transaction are used, and the repo term completely depends on the agreement between a repo seller and a repo buyer. Most of the repo term is 1 day.

vii. Business Hours of the Korea Securities Depository Repo System

The KSD's tri-party repo services are administered from 9:00 a.m. to 5:00 p.m.

If necessary, the KSD may change the business hours, in which case the KSD shall give its participants prior notice on the change of business hours.

viii. Trade Capture and Matching

i. Submission of Details of Repo Trade

Upon the execution of repo transactions, repo sellers (for direct trades) or brokerage firms (for brokered trades) shall submit the details of the repo trade to the KSD. Upon receiving the details of the repo trade, the KSD shall notify repo buyers (for direct trades) of the details of the repo trade, or notify repo sellers and buyers (for brokered trades) of the details of the repo trade.

Table 3.13 Details of the Repo Trade Submitted by Repo Sellers or Brokerage Firms

Item	Content	Option
Basic Information	Counterparty, repo position (buy/sell), purchase price, purchased securities, repo rate	-
Type of Transaction	Term: fixed maturity (enter transaction period) Open: no fixed maturity (no need to enter transaction period)	Term/Open
Transaction/ Single Agreement	-Transaction: to separate from existing trades with the same counterparty and enter into a transaction. -Single agreement: combine with other repo transactions entered into with the same counterparty to form a single agreement.	Transaction/Single
Settlement Agent	If the party wishes to settle through its settlement agent, the name of the settlement agent needs to be entered. (The details of the settlement agent shall be registered in advance.)	A/C No. of securities ledger held with the settlement agent
Methods of Settlement	DVP: simultaneous settlement through the DVP system between the BOK (central bank) and the KSD. FOP: separate settlement of securities and payment (the participant may choose the type of payment).	DVP/FOP
Base Currency	A range of currencies are available for purchase.	Korean won/US dollar/ Japanese yen/euro
Charges	The party subject to the service charges to the KSD	Both parties/Seller/Buyer
Interval of Repo Interest Payment	Enter the interval if it has been agreed that the repo interest shall be paid/received on a regular basis.	Daily, 1-,2-,3-,4-,6-month, Repurchase date
Daily Mark-to-Market	Whether to choose the KSD'S daily Mark-to-Market process	Yes/No
Threshold	To specify the ratio or amount of exemption from the obligation to maintain the margin ("threshold")	Margin amount or ratio
Margin Ratio	Enter the agreed margin ratio, if any. If a margin ratio is not specified, the margin ratio is calculated by dividing the purchased securities' market value on the start-leg settlement date by the purchase price and the ratio is automatically entered into the KSD's repo system.	-
Fund Information	If the sellers or buyers or both parties are asset management companies, fund information is needed	-

A/C =account; BOK = Bank of Korea; DVP = delivery versus payment; FOP = free of payment; KSD = Korea Securities Depository
Source: Korea Securities Depository

ii. Trade Matching

If there is no discrepancy between the details of the repo trade agreed by buyers and sellers, repo sellers or buyers who are notified of the details of the repo trade shall confirm the contents of the details of the repo trade. Upon the completion of confirmation, the KSD shall finalize the settlement statement by giving a Repo reference number for each transaction.

i. Settlement of Repo Trade

i. Start-Leg Settlement

Settlement of securities is done by book-entry transfer from the seller's securities ledger to the buyer's securities ledger. Settlement of fund is done by using the account with the BOK or the account with the commercial bank.

The delivery-versus-payment (DVP) system functions through a direct link between the securities settlement system of the KSD and the financial wire network of the BOK. This allows real time and simultaneous settlement on a gross, trade-by-trade basis for start-leg settlement. If the details of the repo trade are matched, the KSD repo system checks whether there are sufficient numbers of securities for the transactions in the seller's securities ledger. If there are securities sufficient to cover the purchased securities in the account, the KSD system then locks the securities

balance to prevent it from being used for other purposes and instructs the buyer to transfer the funds via the BOK. Upon the buyer's completion of the payment, based on such instruction, the settlement of the purchased securities is executed.

On the other hand, when the trade parties are using the free-of-payment (FOP) method, they should make payment for start-leg settlement using the agreed-upon payment means, and the seller needs to notify that fund settlement has been made through the KSD repo system. Upon such notice by the seller, the settlement of the purchased securities is completed.

ii. Close-Leg Settlement

Repo trades are terminated on the repurchase date. However, if the trade parties agree otherwise, or the event of default occurs, repo trades may be terminated before the repurchase date. In cases where repurchase date is designated at the time of concluding an agreement for repo trades, one party may, at any time, ask the KSD for the termination of the repo transaction with the consent of the other party even before the repurchase date. In cases where there is no designated repurchase date, and unless otherwise agreed upon by the parties of the repo transaction, they shall request for the termination of the repo transaction, provided, that such request is made at least three business days, including the desired repurchase date, in advance.

In case of an event which causes the default of a contractual obligation of a seller or buyer, the repurchase date for the relevant repo transaction shall be deemed to have been prematurely arrived. The KSD shall notify the relevant participants of such fact and terminate the repo transaction. Both DVP and FOP methods can be used for the close-leg settlement.

j. Trade Management

i. Rollover

The parties may apply for rollover on the termination date. In this case, only the existing transactions are terminated on the day when such an adjustment is made, and the parties engage in a new transaction. The settlement may be completed by making payment of the repo interest. Conditions other than the termination date would consistently apply to the new transaction.

ii. Substitution of Purchased Securities

The seller in a repo transaction may substitute the purchased securities, in whole or part, for other securities with the consent of the buyer. Meanwhile, in case the redemption of purchased securities is scheduled or in case depreciation of the purchased securities' market value is expected due to insolvency, decree of bankruptcy, commencement of the rehabilitation proceedings or other reasons on the part of the issuer of the purchased securities, the buyer can request the exchange of purchased securities with other securities. The seller should comply with such request of the buyer.

iii. Change in Repo Trade Conditions

The parties may change part of the trading conditions, if necessary. In this case, the new conditions will apply only to the changed part and all other terms and conditions will remain constant.

k. Mark-to-Market

In order to minimize market risk, the KSD carries out mark-to-market (MTM) on a daily basis. Since the purchased securities is used as collateral in repo trades, the value of the purchased securities must be monitored on a daily basis to ensure that they do not drop below a certain range. Due to the MTM, sellers and buyers can minimize exposure to the risk arising from price fluctuations and enhance the stability of the repo trade. When the repo transaction is terminated, the KSD repo system returns any margin involved in the transaction to each paying party. With regard to purchased securities and margin securities, the KSD shall conduct MTM on a daily basis in the following order:

- i. Calculation of the required collateral value,
- ii. Calculation of the transaction exposure,
- iii. Calculation of the net margin, and
- iv. Calculation of the amount of the net exposure.

After conducting daily MTM, the KSD shall notify repo sellers or buyers of the result of the MTM no later than 10:30 a.m.

The party who incurred the net exposure of the other party shall pay cash margin or securities margin with the consent of the other party. The amount of margin equals to the amount of the net exposure to the other party with net exposure. The margin transfer must be fulfilled no later than 2:00 p.m. on the notified date.

l. Income Payment Management

Although legal title to the purchased securities passes to the buyer in repo trades, economic costs and benefits of the purchased securities remain with the seller. Therefore, if a coupon is paid, it will be handed over to the seller on the coupon value date. The KSD assists the buyer's interest payment process in order to boost the convenience of repo sellers or buyers.

The methods of the interest payment vary depending on whether the purchased securities are held in the repo account of buyer's securities ledger. If the buyer holds the purchased securities in his or her repo account, the interest is automatically paid to the seller. The KSD's repo system will directly pay the interest to the seller on the relevant interest payment date.

On the other hand, if the buyer transferred the purchased securities from his or her repo account to somewhere, the buyer should pay the interest to the seller on the interest payment date through the KSD.

D. FreeBond

1. FreeBond

a. Background

Similar to developed nations, the bond market in Republic of Korea has traditionally used telephone voice trading as a negotiated sale method. With the advances in information technology after the Asian financial crisis, instant messenger became

an important trading method, particularly among young brokers, as the advantages of speed and storage function became widely known. This new method sped up the way trading is executed and enabled market participants to overcome limitations, contributing to the development of the Korean bond market.

However, private messenger undermined price discovery function, and when it crashed or slowed down, the bond market as a whole was paralyzed. In addition, there were structural problems since it was difficult to adapt to the needs of market participants. Against this backdrop, the government created a taskforce in March 2009 and announced the Reformation of Bond Trading Market that October, which aims to establish a specialized bond trading system. Based upon the measure, KOFIA established the online bond trading system, FreeBond and launched it in April 2010.

Since the late 1990s, major developed nations have successfully introduced electronic bond trading systems using advances in information technology. However, in the case of Republic of Korea, legal restrictions have hindered the introduction of alternative trading system(ATS).

b. Main Contents

i. Definition and Composition of FreeBond

FreeBond, operated by KOFIA, enables financial investment firms and market participants to discover quotes and supports trade negotiations. Participants refer to bond trading brokers, dealers, managers, and traders who apply to use the system and are approved by KOFIA pursuant to regulations on registration of financial investment companies. In addition, KOFIA's operation enables continuous communication with market participants, better reflecting the needs of participants.

As for the bond information system (BIS) and information vendors, FreeBond comprise of two main components: instant messenger and T-Board (Figure 3.5). Unlike private messenger, chat rooms are included in the system. T-Board offers trading functions such as bid/ask prices discovery, orders, negotiation and confirmation, and analyses and reference. Instant messenger, a replacement of the current private messenger, provides functions specialized for bond trading including 1: N chatting and automatic storage of chatting records, on top of the general functions of private messenger.

Figure 3.5 Operation of FreeBond

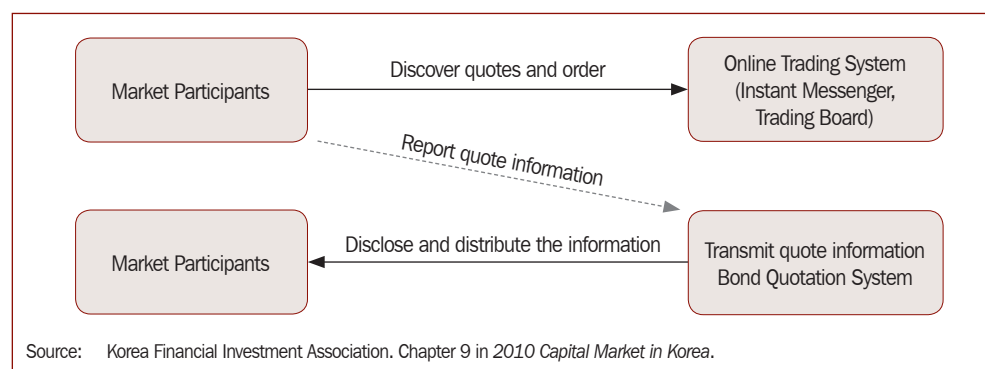

- 1) Market participants discover bid/ask price on FreeBond and execute orders.
- 2) Quote information is transmitted to BQS.
- 3) The concentrated information is disclosed to the market through KOFIA's Bond.

ii. Characteristics of FreeBond

The major strengths of FreeBond are its specialization, security, and stability. In terms of specialization, the system can only be used by bond trading professionals in line with the *Regulation on Business and Operation of Financial Investment Companies*. When a financial investment company applies to use the system and receive approval from KOFIA, bond traders from that company are able to access FreeBond. Under this system, FreeBond can develop into a specialized system, unlike private messenger which anyone can access.

In addition, T-Board enables market participants to find quotes in real time, issues of interest, information on bond issuance, and it offers a bulletin board for trading. Unlike private messenger, chat histories and quotes are encrypted, preventing hacking from occurring. Furthermore, its use is managed by KOFIA's registration process, enhancing credibility in the system.

To boost the stability of FreeBond, the system is backed up with double servers to prevent system failures from trade concentration, and it is managed around the clock.

iii. Expected Effects

The success of FreeBond in the market with its wider use by market participants is expected to become a turning point in the advancement of the OTC bond market in Republic of Korea for the following reasons:

- 1) It will significantly improve the bond trading infrastructure.
- 2) The formalized and safer FreeBond will not only boost the security of bond trading but it will also integrate the market which had been divided by different messenger groups.
- 3) Users can enjoy the ease and convenience of bond trading on FreeBond. Information asymmetry will be reduced, and price discovery and the search of trading counterparts will be easier.

FreeBond was designed by and for bond traders, which makes it especially “market friendly” and thus convenient for users. The system reflects all the requirements needed for trading, such as a variety of trading methods and analyses.

When FreeBond adds the settlement function and builds a global network with advanced bond trading system in the future, foreign investors will find it more convenient to participate in the Korean bond market and domestic financial institutions will be able to expand into overseas markets. This will eventually lead to the globalization of the Korean bond market. In addition, the use of bond market information concentrated in the system will make it possible to calculate real-time bond indices and facilitate the development of new products, such as bond ETFs and interest derivatives.

While the bond and equity markets are the two major pillars supporting the Korea capital market, the bond market is still underdeveloped compared to the equity market. However, the launch of FreeBond will spur the advancement of the bond market, allowing it to serve its main role in the capital market.²¹

Table 3.14 Questions and Answers on FreeBond and Over-the-Counter Trade Matching

Questions	Answers ^a
KSD mentioned OTC trade matching is done at KOFIA, but outside FreeBond; details?	<ul style="list-style-type: none"> • KOFIA does not perform the role of matching over-the-counter bond transactions. • Participants in the over-the-counter bond market including securities firms and investors conduct the discovery of ask/bid prices, negotiations, transactions through FreeBond (KOFIA) and private messenger services such as Yahoo. - After transaction occurs, matching is confirmed by each trading party, and settlement is made in T+1 - T+30 through the KSD's SAFE system and the Bank of Korea's BOK-wire, using delivery versus payment. • Based on the needs of the market and the relevant laws, KOFIA plans to transform FreeBond into an ATS equipped with a settlement function.
KOFIA requires trade reporting within 15 minutes; everybody agrees this is good for transparency, etc.; however, requirement is to report trades at IRC level – this is a big issue for CPs because allocation of trades across individual (IRC) accounts may not happen within 15 minutes; possible chance to help ease market issue	<ul style="list-style-type: none"> • KOFIA's <i>Regulations on Business Conduct and Services of Financial Investment Companies</i> and the Enforcement Bylaws (hereinafter be referred to as the "Regulations, etc.") require financial investment companies to report the trading of bonds to KOFIA within 15 minutes of the trade. However, the 15-minute rule does not apply to commercial papers. ※ Types of bonds subject to the 15-minute rule: government bonds, municipal bonds, monetary stabilization bonds, bank debentures, other financial bonds, corporate bonds, and asset-backed securities - Under separate provisions* of the Regulations, etc., the trading of commercial papers must be reported to KOFIA by 5:30 p.m. on the day of trade. Therefore, the issue described in the question above is not likely to occur. * Art. 7–14 of the "Regulations on Business Conduct and Services" of Financial Investment Companies and Article 52 of the Enforcement Bylaws ※ In accordance with the <i>Act on Issuance and Distribution of Electronic Short-Term Bonds</i>, which is expected to take effect in January 2013, most CPs are likely to be replaced by short-term bonds. In this scenario, the trading of short-term bonds will not be subject to the 15-minute rule.
<p>^a Provided by KOFIA ATS = Alternative Trading System; IRC = investment registration certificate; KOFIA = Korea Financial Investment Association; KSD = Korea Securities Depository; SAFE = Speedy, Accurate, Faithful, and Efficient Source: Korea Exchange. www.krx.co.kr</p>	

E. Secondary Market Yields and Terms of Bond Issues

Table 3.15 Secondary Market Yield and Terms of Bond Issues

Type of Bond	Instrument	Time to Maturity
Government	KTB 3years	2 years 6 months–3 years
	KTB 5 years	4 years 6 months–5 years
	KTB 10 years	9 years–10 years
	KTB 20 years	10 years–20 years
	NHB1 5 years	4 years 6 months– 5 years 1 month
Municipal	Region15 years	4 years 6 months–5 years 1 month
Special	Land 3 years	2 years 6 months–3 years 1 month

continued on next page

²¹ Footnote 1, p. 144–147.

Table 3.15 continuation

Type of Bond	Instrument	Time to Maturity
MSB	MSB 91days	85 days–91 days
	MSB 364 days	10 months–1 year
	MSB 2 years	1 year–2 years
Financial	KDB 1 years	10 months–1 year 1 month
Corporate	Corp 3 years -non AA-	2 years 9 months–3 years

KDB = spell out; KTB = Korea Treasury bond; MSB = monetary stabilization bond; NHB = National Housing Bonds;
Source: Korea Exchange, www.krx.co.kr

F. Transparency in Bond Pricing

Transparency in the Republic of Korea OTC bond market has been enhanced so dramatically due to the KOFIA's role as a self-regulatory organization.

1. The Role of Korea Financial Investment Association

KOFIA, based on FSCMA, FSC Regulations under FSCMA, and FSC Enforcement Rules under FSCMA, manages the information related to the transactions of bonds and their disclosure. Through these actions, KOFIA enhances the price discovery function of the OTC bond market and increases price transparency. In addition, KOFIA is working toward developing a wide variety of policies in order to help the development of the Korean bond market.

2. Disclosure of Real-Time Bond Index

The purpose of the disclosure is to yield real-time bond index based on KOFIA's FreeBond, which is used as a benchmark index for bond ETFs (see Table 3.16).²² The expected effect is to understand real-time trends of the bond market in the following areas:

Table 3.16 Types of Real-Time Bond Index

Index Name	Cycle	Source	First Disc.	Starting Index	Standard Point of Time
MKFTB Index	30 second	FreeBond	June 2009	100	'04.6.16
KTB Index	1 minute	Collected by KRX, etc.	June 2009	10,000	'09.6.1
KEBI TB Index	5 minute	FreeBond	July 2009	100	'09.6.30
MK MSB Index	1 minute	FreeBond	January 2010	10,000	'10.1.1
MK MMI* Index	1 minute	FreeBond	July 2010	10,000	'10.6.1
KOBI Credit Index	1 minute	FreeBond	December 2010	10,000	'10.9.1

Source: Korea Financial Investment Association

- a. (Investor-side) Facilitate spread trading between spot bonds and bond ETFs, and enable investment in baby bonds.
- b. (Issuer-side) Reduce capital-raising costs due to the increased demand.
- c. (Financial firms-side) Use as a standard to evaluate investment performance and as a risk management index.

²² Footnote 1, p.156–159.

G. Business Process Flowchart (Over-the-Counter Market/Delivery versus Payment)

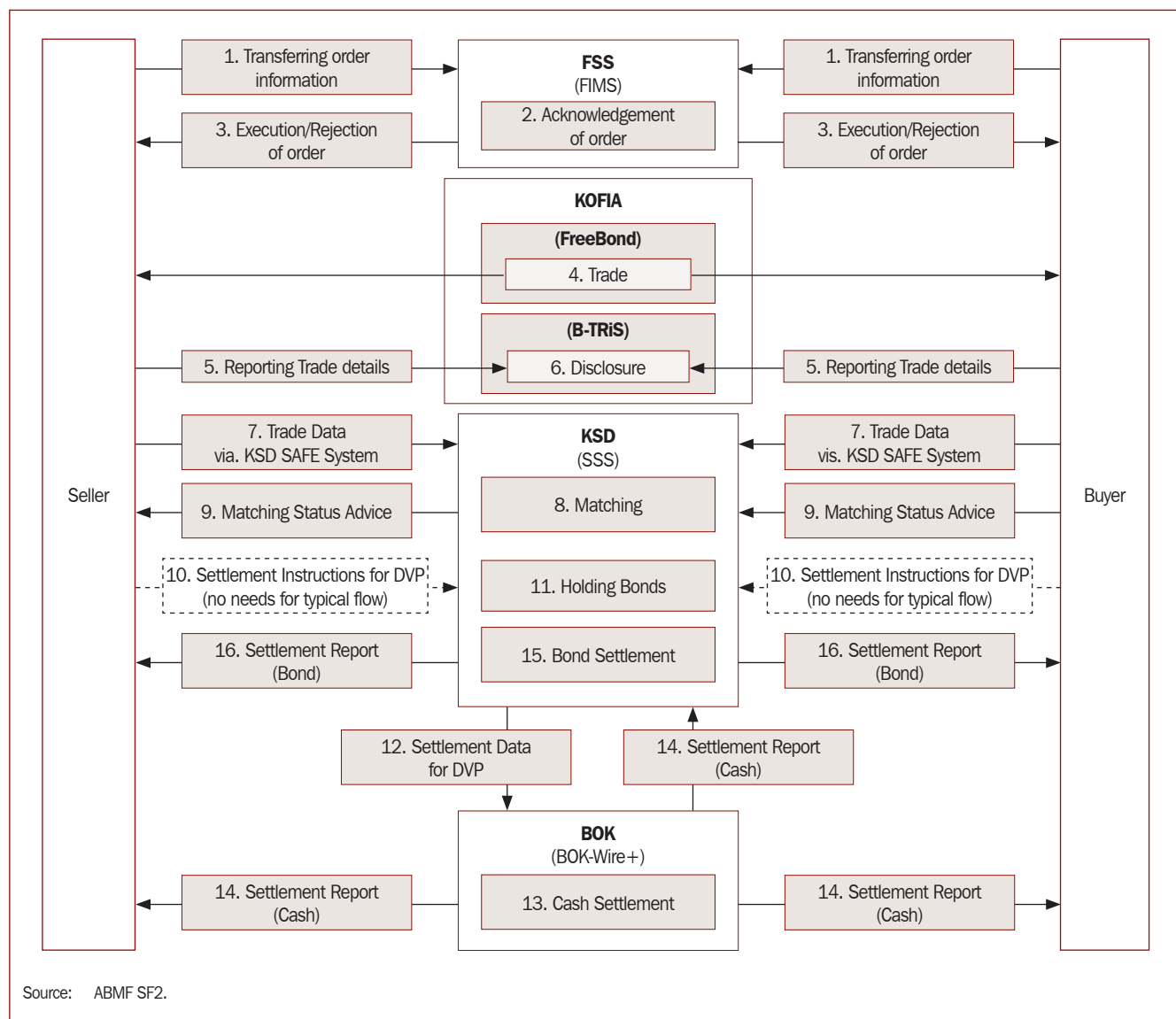

OTC Market

1. If the client is a foreign investor, the seller side and/or the buyer side of securities companies transfer order information to Financial Supervisory Service (FSS) via Foreign Investment Management System (FIMS).
2. FSS acknowledges or rejects order.
3. If holding is enough, FSS transfers order information to the seller side and/or the buyer side of securities companies and Korea Exchange.
4. The seller and buyer trade over the counter with a formalized bond trading system, whose name is FreeBond.
5. Both the seller and buyer must report trading details to the KOFIA within 15 minutes after trading execution.
6. KOFIA discloses this information on its Bond-Trade Report and Information Service (B-TrIS).

7. The seller and buyer send trade data to KSD.
8. KSD collates trade data from the seller and buyer.
9. KSD sends matching status advise to the seller and buyer.
10. The seller and buyer send settlement instructions for DVP to KSD.
11. KSD holds bonds before cash settlement.
12. KSD sends settlement data to BOK.
13. BOK executes cash settlement.
14. BOK sends settlement report to the seller, the buyer and KSD.
15. KSD executes bond settlement.
16. KSD sends settlement report to the seller and buyer.

H. Business Process Flowchart (Exchange Market/Delivery versus Payment)

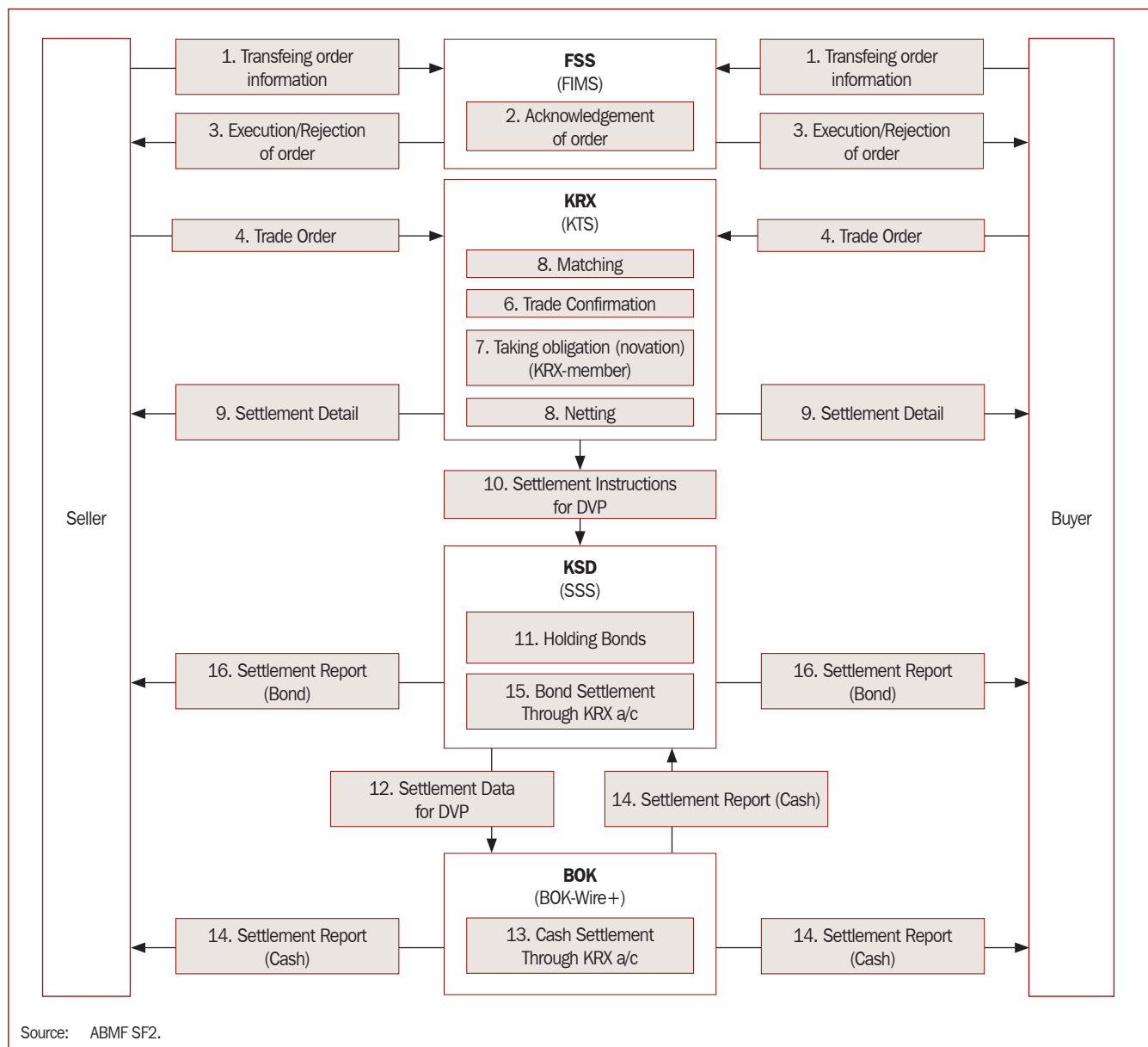

Clearing / Settlement Flow Chart provided by Korea Exchange

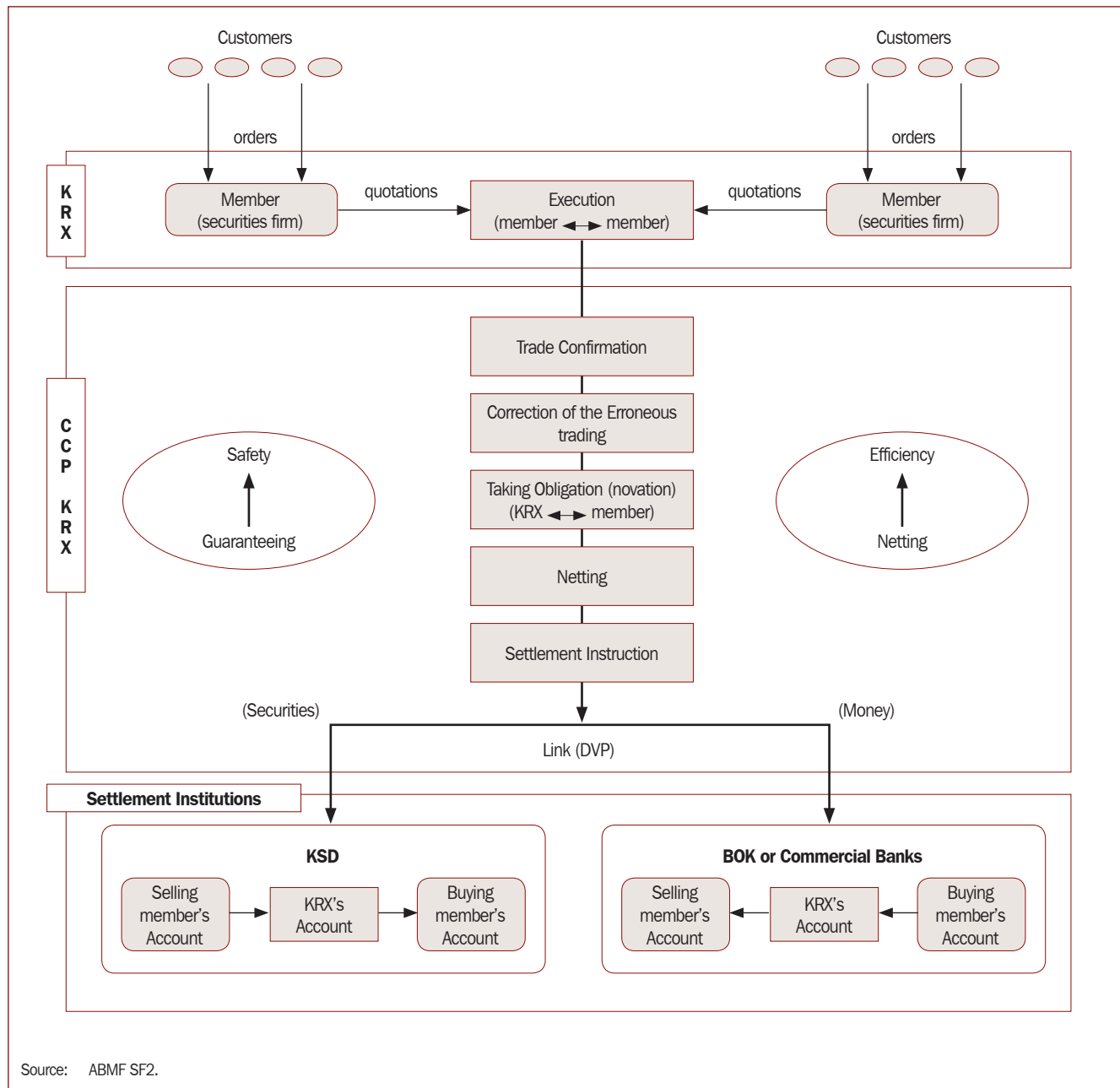

Source: ABMF SF2.

I. Korea Over-the-Counter Bond Transaction Flow (For Foreign Investors)

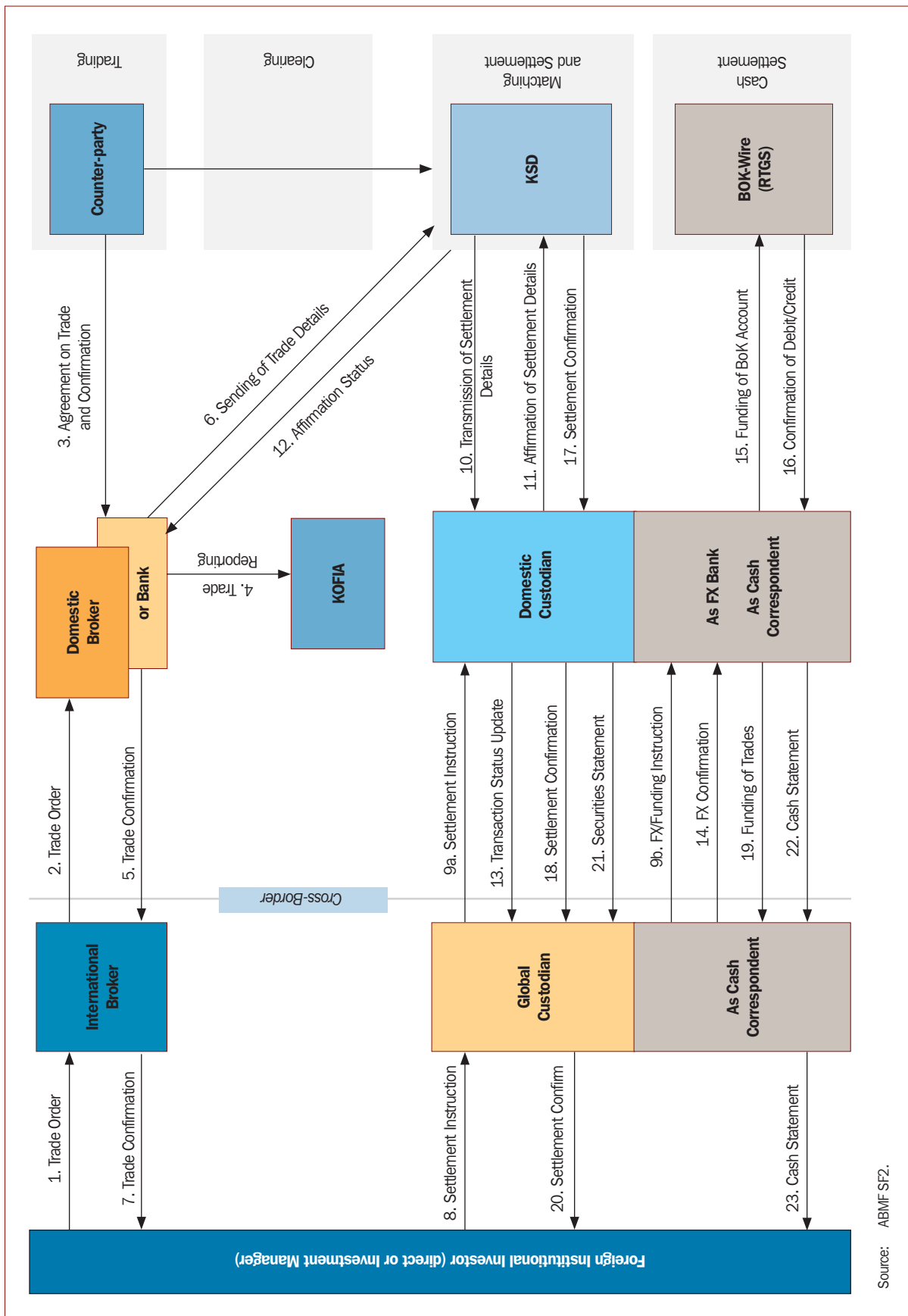

Source: ABMF SF2.

Trade Date: T
Settlement Date: T+2

Description of Steps in the OTC Bond Transaction Flow for Foreign Investors

Trade Date

1. Foreign Institutional Investor places order with International Broker
2. International Broker places order with Domestic Broker/Bank
3. Domestic Broker/Bank trades OTC with Counterparty (via phone or, e.g., Bloomberg)
4. Domestic Broker/Bank and Counterparty report trade to KOFIA within 15 minutes of trade
5. Domestic Broker/Bank send trade confirmation to International Broker
6. Domestic Broker/Bank sends trade details to KSD
7. Foreign Institutional Investor receives trade confirmation

T+1

8. Foreign Institutional Investor instructs Global Custodian on securities settlement details, and foreign exchange (FX)/funding
9. Global Custodian instructs Domestic Custodian on (a) securities settlement details, and (b) FX/funding requirements
10. KSD sends Preliminary Settlement Data to Domestic Custodian, via SAFE
11. Domestic Custodian affirms settlement details
12. KSD sends affirmation status to Domestic Broker/Bank
13. Domestic Custodian reports transaction status update to Global Custodian
14. Domestic Custodian sends FX confirmation to Global Custodian

Settlement Date

15. Domestic Custodian funds BOK account
16. Upon transfer of cash, BOK sends settlement confirmation to Domestic Custodian
17. Upon transfer of securities, KSD sends settlement confirmation to Domestic Custodian
18. Domestic Custodian sends settlement confirmation to Global Custodian
19. Global Custodian funds account with Domestic Custodian, or into foreign currency (FCY) nostro (before end of day)
20. Global Custodian sends settlement confirmation to Foreign Institutional Investor
21. Domestic Custodian sends securities statement to Global Custodian
22. Domestic Custodian sends cash credit/debit confirmation in cash statement to Global Custodian
23. Global Custodian sends credit/debit confirmation in cash statement to Foreign Institutional Investor (FII)

Additional Comments on the OTC Bond Transaction Flow for Foreign Investors

- Bond transactions in the OTC market have been subject to mandatory book-entry settlement (at KSD) since 1995. Market participants pre-match through KSD's InSet system

- OTC market participants have option to negotiate settlement date between T+1 and T+30. Assumption of T+2 of more representative for FII trades
- 4 – Trade reporting by all trading counterparties to KOFIA within 15 minutes
- 6 – Here, trading counterparties actually send trade details into KSD
- 10 – KSD sends future settlement details to Domestic Custodian, and
- 11 – Domestic Custodian only needs to affirm/confirm details, based on client instructions received
- 12 – Subsequently, KSD send affirmation status back to trading counterparty
- 16,17 – Sequence set based on typical sequence in other markets, where CSD sends request for funding, cash then settles first, upon which securities side settles; whether sequence of actual sending confirmations is as expected, would need to be confirmed

Table 3.17 Questions and Answers related to Market Infrastructure: InSet and SAFE

Questions	Answers ^a
<p>Exactly what does InSet represent, at what stage in the settlement process?</p>	<p>1) Definition</p> <p>InSet stands for Institutional Settlement, and refers to the settlement of over-the-counter (OTC) securities. For OTC bond transactions, Bond Institutional Settlement handles the entire settlement process.</p> <p>2) Features</p> <p>(RTGS) The Bond Institutional Settlement system processes the settlement of securities and cash for OTC transactions of bonds, CDs, and CPs in the RTGS (Real-Time Gross Settlement, DVP model 1) method to eliminate principal risk.</p> <p>(Consecutive settlement) In addition, taking account of the characteristics of OTC bond transactions, the Bond Institutional Settlement also implemented 'consecutive settlement,' to reduce settlement liquidity risk for participants.</p> <p>(Cash settlement through central bank) The Bond Institutional Settlement system is connected to the Bank of Korea BOK-Wire+ by CCF (Computer-to-Computer Facility) method, and settlement operations are conducted by exchanging electronic messages.</p> <p>3) Access paths</p> <p>(Participation) An application must be submitted to participate in Bond Institutional Settlement. The documents required for application are Account Opening and Participation Application Form, Cash Settlement Account Reporting Form, and documentation for authorized operations staff.</p> <p>(Link between participant and KSD) The participant (securities firm, asset management company, custodian bank, etc.) is linked to KSD by CCF. Participants who do not have this type of connection can process operations by means of web server.</p>
<p>Exactly what does SAFE represent, at what stage in the settlement process: we also heard of SAFE+?</p>	<p>SAFE is the acronym of the information technology (IT) system implemented and operated by KSD in order to conduct its CSD functions. (SAFE stands for Speedy, Accurate, Faithful and Efficient.) SAFE+ (SAFE Plus) is KSD's next generation system. The former system was overhauled to enhance efficiency and stability. SAFE+ went live in February 2011 and it is the current system operated by KSD.^b</p>

continued on next page

Table 3.17 continuation

Questions	Answers ^a												
<p>KSD's Next Generation System SAFE+? (Korea Securities Depository Newsletter)</p>	<p>KSD's Next Generation System SAFE + went live on 7 February 2011, after a development period of over 23 months.</p> <p>Background: The object of KSD's Next Generation System implementation was to respond swiftly and flexibly to rapidly changing financial environment and customer needs, and to evolve into a customer-oriented low-cost high-performance global IT system. Ten years had passed since the existing SAFE system was set up, and the aging IT system and low capacity became factors of instability and reduced scalability. The lack of system flexibility restricted the entry of new products, and expansion of account number and account book structures, as well as causing other IT and business operations issues. These factors ultimately necessitated the implementation of a new IT system.</p> <p>KSD Next Generation System Implementation Background</p> <ol style="list-style-type: none"> 1) Instability and lack of scalability due to aging system and insufficient capacity 2) Restrictions on introducing new products and creating global linkages caused by the system's complexity and lack of flexibility 3) Increasing customer complaints and unsatisfactory response to various customer needs due to provider-oriented IT scheme 4) Limitations on accommodating new participant and services types due to lack of scalability 5) A need to prepare foundation for introducing the Electronic Securities System <p>Development Period KSD launched the Next Generation IT System Task Force in July 2007, and established a comprehensive implementation plan. Then in the project preparation stage, BPR/ISP consulting for system implementation was conducted for six months beginning from December 2007 in order to establish the directions and Master Plan. Based on the results of the BPR/ISP consulting, the SI, external PMO and system auditor for the project were selected, and the SI project took off on 6 March 2009. * SI Project Period: 6 March 2009 to 7 February 2011 (23.5 months)</p> <p>Major Tasks Twelve project tasks including backbone system implementation went live in three stages. The SI project commenced in March 2009, with the 1st stage ITAMS system going live in October 2009, and the ERP and EP system in 30 November 2009. The backbone operations system, the core of the Next Generation System, was developed for a period of 23.5 months: analysis 4 months, design 5 months, development 7 months, integration testing 5 months, and user testing 2 months.</p> <p>Next Generation System Project Tasks</p> <table border="1" style="width: 100%; border-collapse: collapse;"> <thead> <tr style="background-color: #008080; color: white;"> <th>Stage</th> <th>Project Task</th> <th>Live Date</th> </tr> </thead> <tbody> <tr> <td>Stage 1</td> <td>ITAMS</td> <td>26 October 2009</td> </tr> <tr> <td>Stage 2</td> <td>ERP EP(Enterprise Portal)</td> <td>30 November 2009</td> </tr> <tr> <td>Stage 3</td> <td>Backbone operation system Data standardization and metadata system Network Server/infrastructure Database system Security system AP based monitoring system (ATMS) Integrated IT management system (ITMS) Unified messaging system (UMS)</td> <td>7 February 2011</td> </tr> </tbody> </table>	Stage	Project Task	Live Date	Stage 1	ITAMS	26 October 2009	Stage 2	ERP EP(Enterprise Portal)	30 November 2009	Stage 3	Backbone operation system Data standardization and metadata system Network Server/infrastructure Database system Security system AP based monitoring system (ATMS) Integrated IT management system (ITMS) Unified messaging system (UMS)	7 February 2011
Stage	Project Task	Live Date											
Stage 1	ITAMS	26 October 2009											
Stage 2	ERP EP(Enterprise Portal)	30 November 2009											
Stage 3	Backbone operation system Data standardization and metadata system Network Server/infrastructure Database system Security system AP based monitoring system (ATMS) Integrated IT management system (ITMS) Unified messaging system (UMS)	7 February 2011											

continued on next page

Table 3.17 continuation

Questions	Answers ^a																											
	Backbone operation system program development scale: 6,285 lines of code (LOC)																											
	<table border="1" style="width: 100%; border-collapse: collapse;"> <thead> <tr> <th style="background-color: #008080; color: white;">Operation</th> <th style="background-color: #008080; color: white;">LOC</th> <th style="background-color: #008080; color: white;">Operation</th> <th style="background-color: #008080; color: white;">LOC</th> </tr> </thead> <tbody> <tr> <td>Securities Deposit</td> <td>962</td> <td>Securities Settlement</td> <td>495</td> </tr> <tr> <td>Entitlements</td> <td>557</td> <td>Collective Investment</td> <td>951</td> </tr> <tr> <td>Securities Management</td> <td>971</td> <td>Transfer Agent</td> <td>706</td> </tr> <tr> <td>International</td> <td>553</td> <td>Securities Registration</td> <td>474</td> </tr> <tr> <td>Securities Info</td> <td>188</td> <td>Common</td> <td>428</td> </tr> </tbody> </table>				Operation	LOC	Operation	LOC	Securities Deposit	962	Securities Settlement	495	Entitlements	557	Collective Investment	951	Securities Management	971	Transfer Agent	706	International	553	Securities Registration	474	Securities Info	188	Common	428
Operation	LOC	Operation	LOC																									
Securities Deposit	962	Securities Settlement	495																									
Entitlements	557	Collective Investment	951																									
Securities Management	971	Transfer Agent	706																									
International	553	Securities Registration	474																									
Securities Info	188	Common	428																									
	<p>Additionally, the KSD Next Generation System implementation project applied organized project management and methodology in conducting the project, and attained CMMI* Level3 upon system launch.</p> <p>* Capability Maturity Model Integration (CMMI): System development and maintenance process improvement and organization maturity model developed by the Carnegie Mellon Software Engineering Institute (SEI)</p> <p>Major Changes After Implementing the Next Generation System</p> <p>The deposit and settlement system was overhauled and re-implemented to realize a customer-oriented system, bringing the following changes in terms of customers, IT system and business operations.</p> <p>1) Enhanced customer convenience and service quality</p> <ul style="list-style-type: none"> • Customer-oriented User Interface. The previously separate SAFE and e-SAFE systems were integrated into a single UI to increase convenience. The new UI combines the former interface which was divided by the type of securities, operations and system into one single user-friendly UI. • Improved file download/upload function. Automatic transmission of large volume data, such as beneficial owners lists which customers frequently send to KSD, by means of a Web Service method was introduced, eliminating the inconvenience of manually uploading and downloading files and enabling swift data processing. <ul style="list-style-type: none"> * HTTP and standardized messaging (XML) based data delivery method • Integrated customer and user info management. User information, which had previously been managed separately for each system, has been integrated into one data management system to enhance customer service support. <p>2) Scalable and flexible system</p> <ul style="list-style-type: none"> • Support for electronic underwriting and issuance for financial bonds. Financial bond issuance and underwriting information was previously exchanged by means of instant messaging clients. The new system incorporated it into the financial bond electronic underwriting and issuance support system, enhancing efficiency and reducing risk. <p>Data regarding issuance/underwriting, pre-notices, contracts, and related documents can be received and processed through the system.</p> • Speedier accommodation of new instruments. The operation of the deposit system used to be divided by securities type. It is now integrated to enable the flexible accommodation of new instruments. • Foundation for the Electronic Securities System. By building a web system exclusively for issuing companies, one-stop services for corporate actions including capital increase, voting and appraisal rights can be provided. This also prepares the ground for retail investors and non-financial companies to hold deposit accounts as direct participants when the Electronic Securities System is implemented. <p>3) Enhanced stability and efficiency of deposit & settlement services</p> <ul style="list-style-type: none"> • Reorganized participant account number and management structure. The account numbering system has been extended (7 digits → 12 digits) to prepare for the inclusion of different account types after the implementation of the Electronic Securities System. • Set-up for absorption of Separate Safe Custody System into Deposit System. The transition of the Separate Safe Custody System, based on physical shares, into the Deposit System, will be promoted in order to eliminate the inefficiency of issuing paper certificates and remove the legal risk associated with the beneficial owner and safe custody applicant being different parties. 																											

continued on next page

Table 3.17 continuation

Questions	Answers ^a																					
	<ul style="list-style-type: none"> Enhanced support for derivatives services. The application of the Computer to Computer Facility (CCF) method was expanded for securities lending and borrowing, Repo and secured call loan management system to dramatically speed up operation processing. Expanded processing capacity of FundNet. In response to the growth and globalization of the fund market, the daily processing capacity of FundNet has been tripled (22,000 to approximately 60,000 cases). Increased automation of corporate actions processing for foreign currency securities. The scope of automated corporate action services for foreign currency securities has increased from one type (cash dividends) to 6 types (capital increase, stock dividends, voting rights, etc.). <p>4) Application of latest IT and increased performance</p> <ul style="list-style-type: none"> For development, the CBD methodology was applied to draw business components to increase development productivity and enhance system scalability and flexibility. In terms of UI, .Net Smart Client technology was adopted to improve performance and maximize user convenience. The server and daily processing capacity has been doubled from that of the previous system. Processing speed is also expected to be twice as fast as the former system. <p>KSD Next Generation System IT and Performance Changes</p> <table border="1" style="width: 100%; border-collapse: collapse;"> <thead> <tr> <th style="background-color: #008080; color: white;">Division</th> <th style="background-color: #008080; color: white;">SAFE</th> <th style="background-color: #008080; color: white;">SAFE PLUS</th> </tr> </thead> <tbody> <tr> <td>Development Methodology</td> <td>Information Engineering</td> <td>Component-Based Development (CBD)</td> </tr> <tr> <td>UI</td> <td>ActiveX-Internet</td> <td>.Net Smart Client</td> </tr> <tr> <td>Interface</td> <td>Closed and Web (html)</td> <td>SOA-oriented Web Service</td> </tr> <tr> <td>Server Capacity</td> <td>approx 2.2 million tpmc</td> <td>approx 6.45 million (2.9)</td> </tr> <tr> <td>Processing Capacity (Daily)</td> <td>approx 3.8 million</td> <td>approx 8.34 (2.2)</td> </tr> <tr> <td>Processing Speed</td> <td colspan="2">Speed increased over x 2</td> </tr> </tbody> </table> <p>Expected Effects</p> <p>KSD's Next Generation System has been developed with the objectives of: i) expanding automation of operations, ii) creating customer-friendly user interface, iii) expanding processing capacity to respond to changes in the financial environment, and iv) implementing a system compliant with international standards. The implementation of the Next Generation System is expected to bring cost reduction and value improvement amounting to about W43 billion annually for the entire market including both KSD and customers.</p>	Division	SAFE	SAFE PLUS	Development Methodology	Information Engineering	Component-Based Development (CBD)	UI	ActiveX-Internet	.Net Smart Client	Interface	Closed and Web (html)	SOA-oriented Web Service	Server Capacity	approx 2.2 million tpmc	approx 6.45 million (2.9)	Processing Capacity (Daily)	approx 3.8 million	approx 8.34 (2.2)	Processing Speed	Speed increased over x 2	
Division	SAFE	SAFE PLUS																				
Development Methodology	Information Engineering	Component-Based Development (CBD)																				
UI	ActiveX-Internet	.Net Smart Client																				
Interface	Closed and Web (html)	SOA-oriented Web Service																				
Server Capacity	approx 2.2 million tpmc	approx 6.45 million (2.9)																				
Processing Capacity (Daily)	approx 3.8 million	approx 8.34 (2.2)																				
Processing Speed	Speed increased over x 2																					
<p>^a Answer provided by Korea Securities Depository.</p> <p>^b Details are shown on the article in <i>KSD Newsletter</i>, Spring 2011.</p> <p>Source: Korea Securities Depository.</p>																						

Table 3.18 Questions and Answers related to Clearing/Securities Settlement (Answered by KSD)

Questions	Answers ^a																		
<p>Please provide a very detailed flow identifying components and cut-off times, after internal deliberation:</p>	<p>Daily Operations</p> <ul style="list-style-type: none"> • Receipt of trade report and affirmation (by 7:00 p.m. on T+0) Participant, ISIN, Quantity, Price, Consideration, Classification for bid or offer, Intended settlement date, Commission, Tax, etc. • Correction of trade report is possible • Transmission of settlement statement (7:00 p.m. on T+0) • Securities block of the seller's deposited balance (from 9:30 a.m. on T+1) • Delivery and Payment (from 9:30 a.m. to 5:00 p.m. on T+1) <div data-bbox="516 573 1442 1423" style="border: 1px solid black; padding: 10px;"> <p style="text-align: center;">IS Systems – Bond (fund) KSD </p> <p style="font-size: small;">Source: ?????.</p> </div>																		
<p>Market materials mention T+1 to T+30: some market participants mentioned T+0 settlements: so is it rather T+0 to T+30?</p>	<p>It depends on what criterion is used. The settlement cycle of OTC bonds transactions is T-1 to T+30. However, if exceptions and other transactions are included, the settlement cycle can be deemed to be T+0 to T+30.</p> <table border="1" data-bbox="503 1554 1437 1764"> <thead> <tr> <th>KRX/OTC</th> <th>Securities Type</th> <th>Settlement Cycle</th> </tr> </thead> <tbody> <tr> <td>KRX</td> <td>Trading of Government Bond</td> <td>T+1</td> </tr> <tr> <td>KRX</td> <td>Trading of Bond Repurchase Agreement</td> <td>T</td> </tr> <tr> <td>KRX</td> <td>Trading of Retail Bond</td> <td>T</td> </tr> <tr> <td>OTC</td> <td>Bonds</td> <td>T+1(T*)~T+30</td> </tr> <tr> <td>OTC</td> <td>CD, CP</td> <td>T</td> </tr> </tbody> </table> <p style="font-size: x-small;">* Settlement on trade day (T) is possible in some exceptional cases.</p>	KRX/OTC	Securities Type	Settlement Cycle	KRX	Trading of Government Bond	T+1	KRX	Trading of Bond Repurchase Agreement	T	KRX	Trading of Retail Bond	T	OTC	Bonds	T+1(T*)~T+30	OTC	CD, CP	T
KRX/OTC	Securities Type	Settlement Cycle																	
KRX	Trading of Government Bond	T+1																	
KRX	Trading of Bond Repurchase Agreement	T																	
KRX	Trading of Retail Bond	T																	
OTC	Bonds	T+1(T*)~T+30																	
OTC	CD, CP	T																	
<p>Officially T+1 for bonds, but T+2 to T+4 evident for FII trades: key question: what should be the mention in the SF1 'ultimate market guide'?</p>	<p>The settlement cycle of the KSD bond settlement system is T+1 (from date of Trade Data input to date of Settlement Completion).</p>																		

Table 3.18 continuation

Questions	Answers ^a
KSD system (which one actually) cut-off for OTC trades at EOD on T: Custodians cannot confirm in absence of client instruction: brokers forced to cancel/delete trade; then re-input into KSD on T+1(which could be SD).	<p>There are two types of cut-off in the KSD system. One is the cut-off for inputting trade data on trade date (T), and the other is the cut-off for settlement on settlement date (T+1).</p> <p>Your statement above describes a situation in which the broker has entered the trade data before the EOD on T but the custodian has not confirmed the trade due to delay/absence of instruction from the client, causing the broker to delete the trade and re-input them on the next day (settlement date).</p> <p>However, if trade data is entered before the cut-off, and the custodian is unable to confirm the trades that day, the custodian can confirm the trades next day on the settlement date and process the settlement. Therefore, there is no need for the broker to delete the trade data and re-enter it on the settlement date.</p>
<p>^a Answer provided by Korea Securities Depository. Source: Korea Securities Depository..</p>	

J. Short Sale of Bonds

The regulating method on short sale of bonds is stipulated in FSCMA and Enforcement Rule of FSCMA. The regulation on short sale of bonds is less strict compared to that of equity securities. According to FSCMA, investors are not allowed to make short sale on the listed equity-linked bonds such as convertible bonds, bonds with warrant, participating bonds, and exchangeable bonds. On the other hand, other bonds are eligible for short sale.

As far as the listed equity-linked bonds, while naked short sale is not permitted, covered short sale is allowed. In case of conducting a covered short sale or placing a quotation after receiving an entrustment for a covered short sale, a member should not submit the quotation at a price lower than the latest market price.

In the OTC market, Enforcement Decree of FSCMA and Enforcement Rule of FSCMA allow only the “investment trader” prescribed in FSCMA to conduct short sale of bonds, both covered short sale and naked short sale. When conducting the short sale, the quotation price should be lower than the latest market price of both in the KRX market and OTC market. However, banks are currently prohibited from conducting the naked short sale.

K. Korea Treasury Bonds Exchange-Traded Funds Market

The enforcement of the FSCMA in February 2009 has led the introduction of ETFs tracking the yields of KTBs.²³ Subsequently, 3-year KTB ETFs were introduced in July 2009. Since KTBs are traded in the inter-dealer market in the Korea Exchange (“KRX”) participated by mainly Institutional Investors, where the minimum trading unit is KRW 1 billion, and in the OTC market participated by the securities companies, where the average trading unit is KRW 10 billion, it is not easy for the retail investors to directly invest in KTBs. However, since KTB ETFs are priced at a range of W5,000 to W100,000 per share, the retail investors with small investment capital can easily purchases KTB ETFs, subsequently increasing the popularity of bond investment. As

²³ An Exchange Traded Fund (ETF) is an index fund designed to track the movement of underlying index and is traded like stocks in the exchanges. As an index fund, ETF offers the convenience of trading stocks, as well as the advantage of diversified investment.

of May 2010, five ETFs tracking the yield of 3-year KTBs are listed in the KRX, and it is expected that more KTB ETFs will be listed in the future.

To list KTB ETF on the KRX, the asset under management must be at least W10 billion and more than 100,000 shares must be issued. Settlement method of KTB ETF is the same as that of stocks. KTB ETF is settled on T+2 day, using the book entry clearing method through the account in the KSD.

Figure 3.6 Process to List or Trade KTB ETF on the KRX

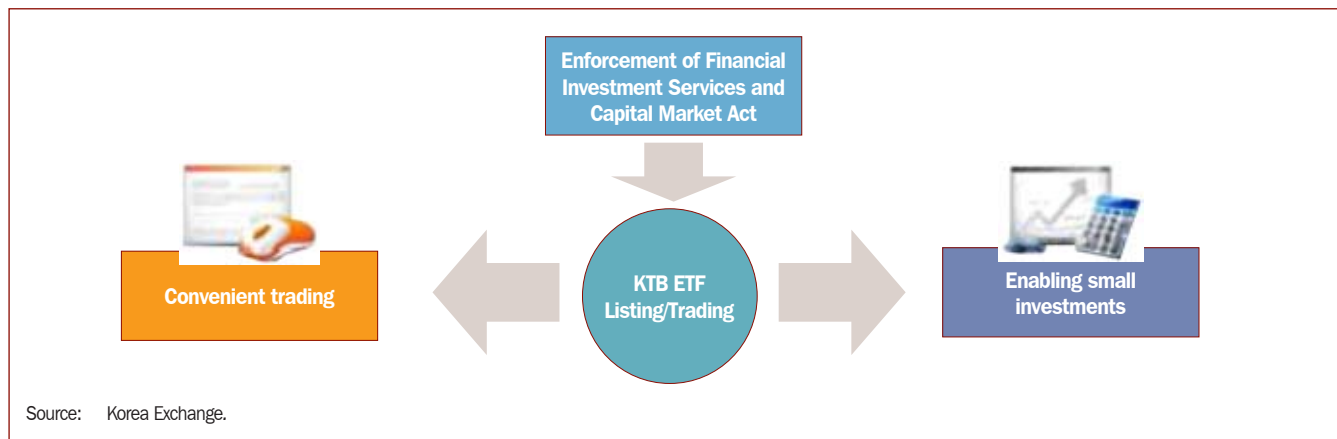

Table 3.19 Listed Korea Treasury Bond Exchange-Traded Funds

Bond Index	Management Company	Name of ETF	Trust Principal	Listed Date
KTB index	Woori Asset Management	KOSEF KTB	W300 billion	31 July 2009
	KB Asset Management	K-Star KTB	W300 billion	29 July 2009
	Mirae Asset Maps	Tiger KTB3Y	W120 billion	27 August 2009
	Korea Investment Trust	KINDEX TB	W100 billion	31 July 2009
MKF TBI	Samsung Asset Management	KODEX TBOND	W100 billion	29 July 2009

Source: Korea Exchange.

Table 3.20 Korea Treasury Bond Exchange-Traded Funds Trading System

Item	Description
Trading hour	Regular session (9:00 a.m. – 3:00 p.m.) Off-hours session (7:30 a.m. – 8:30 a.m., 3:10 p.m. – 6:00 p.m.)
Tick size	W5
Trading unit	1 unit
Daily price limit	± 15%
Types of orders	Limit order, Market order, Limit-to-market-on-close order, Immediately executable limit order, Best limit order
Short selling	Allowed (Uptick rule is not applied)

* Trading hour, daily price limit and the types of order are the same as those of stocks.

Source: Korea Exchange.

L. Separate Trading of Registered Interest and Principal of Securities

Separate Trading of Registered Interest and Principal of Securities (STRPS) refers to the bonds whose coupons have been separated from the principal.

Figure 3.7 Separate Trading of Registered Interest and Principal of Securities

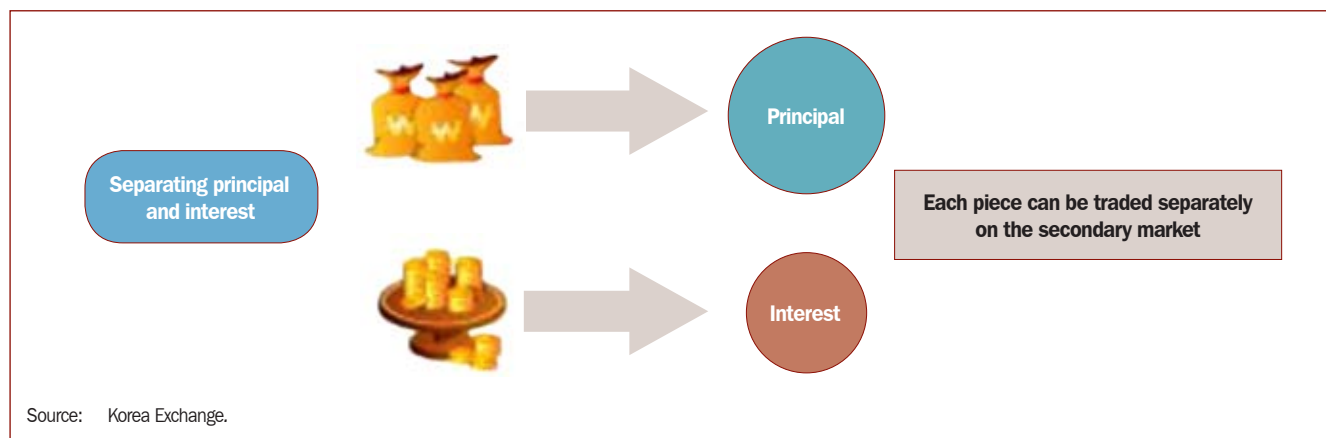

For example, 5-year KTB issued on 10 September 2010 pays the interests on 10 March and 10 September of each year for the next 5 years. By stripping this 5-year KTB, a total of 11 zero-coupon bonds (10 coupon payments and one principal) may be traded. The opposite concept of the STRIPS is called “reconstitution,” which is recombining each zero coupon bonds into original one.

STRIPS was first introduced in the US in 1985, and now used in many Organisation of Economic Co-Operation and Development countries, including Canada, Belgium, Germany, Italy and Japan. Republic of Korea first introduced STRIPS for 5-year KTB in March 2006 to promote the growth of market for long-term bonds. However, the stripping of KTBi is not allowed because the principal of KTBi is linked to inflation. The KTB holder can request stripping of KTB using the BOK-Wire via the KSD. Same method can be applied to send the written request for the reconstruction.

M. Bond-Related Futures Market: Korea Treasury Bonds Futures Market

1. Korea Treasury Bonds Futures Trading System

As the issuance volume of KTBs increased, KTB futures was introduced to provide a risk management tool in September 1999. Along with the growth of bond market size and introduction of bond mark-to-market requirement in July 2000, there was a need to manage the risk associated with the price volatility. To address this need, 3-year KTB futures was introduced first, and then 5-year KTB futures in August 2003 and 10-year KTB futures in February 2008 to provide the tools for managing the risk of price volatility of medium-term and long-term KTB.

Table 3.21 Korea Treasury Bonds Futures Trading System

	10 year KTB Futures	5 year KTB Futures	3 year KTB Futures
Underlying asset	10 year KTBs with 5% coupon rate (Face value W100 million)	5 year KTBs with 5% coupon rate (Face value W100 million)	3 year KTBs with 5% coupon rate (Face value W100 million)
Trading unit	Face value W100 million	Face value W100 million	Face value W100 million
Tick size	0.01	0.01	0.01
Tick value	W10,000 (= 100,000,000 × 0.01 × 1/100)	W10,000 (= 100,000,000 × 0.01 × 1/100)	W10,000 (= 100,000,000 × 0.01 × 1/100)
Trading hour	9:00 a.m. – 3:15 p.m. (Last trading day: 9:00 a.m. – 11:30 a.m.)	9:00 a.m. – 3:15 p.m. (Last trading day: 9:00 a.m. – 11:30 a.m.)	9:00 a.m. – 3:15 p.m. (Last trading day: 9:00 a.m. – 11:30 a.m.)
Contract month cycle (Listed contract months)	March, June, September, and December (2 contract months)	March, June, September, and December (2 contract months)	March, June, September, and December (2 contract months)
Last trading day (Final Settlement day)	Third Tuesday of the contract month (the next business day following the last trading day: t+1)	Third Tuesday of the contract month (the next business day following the last trading day: t+1)	Third Tuesday of the contract month (the next business day following the last trading day: t+1)
Settlement method	Cash settlement	Cash settlement	Cash settlement
Daily price limit	None	None	None
Quotation price limit	Base price ± 2.7%	Base price ± 1.8%	Base price ± 1.5%
Launch date	25 February 2003	22 August 2003	29 September 1999

Source: Korea Exchange.

2. Specification of 3-Year Korea Treasury Bond Futures

Table 3.22 3-Year Korea Treasury Bonds Futures

Item	Description
Underlying Asset	3-Year Korea Treasury Bond with 5% coupon rate and semiannual coupon payment
Contract Size	W100 million
Contract Months	The first two consecutive months in the quarterly cycle (March, June, September, and December)
Trading Hours	9:00 a.m. to 3:15 p.m. (09:00 a.m. to 11:30 a.m. on the last trading day)
Tick Size and Value	0.01 point, representing a value of W10,000
Last Trading Day	Third Tuesday of the contract month
Final Settlement Day	The following day of the last trading day
Final Settlement	Cash
Position Limit	It can be adopted when the KRX deems necessary
Listing Date	29 September 1999

Source: Korea Exchange.

3. Underlying Basket Bonds for 3-Year Korea Treasury Bond Futures

Table 3.23 Underlying Basket Bonds for 3-Year Korea Treasury Bonds Futures

Underlying basket bonds used to determine the final settlement price for KTB3 F 1203				
Issue Name	Code No.	Issue Date	Maturity	Coupon Rate
Treasury 0350-1406	KR1035017162	10 June 2011	10 June 2014	3.50%
Treasury 0300-1312	KR10350170C2	10 December 2010	10 December 2013	3.00%
Treasury 0350-1609	KR1035017196	10 September 2011	10 September 2016	3.50%

continued on next page

Table 3.23 continuation

Underlying basket bonds used to determine the final settlement price for KTB3 F 1206				
Issue Name	Code No.	Issue Date	Maturity	Coupon Rate
Treasury 0325-1412	KR1035017100	December 10, 2011	December 10, 2014	3.25%
Treasury 0350-1406	KR1035017162	June 10, 2011	June 10, 2014	3.50%
Treasury 0350-1609	KR1035017196	September 10, 2011	September 10, 2016	3.50%

Source: Korea Exchange.

Among KTBs with a 6-month coupon payment, KRX has the discretion to select single or plural bonds which will be included in the basket and then used to compute the final settlement price. KOFIA sends KRX the yields for each individual bond in the basket, as of 11:30 a.m. and 3:30 p.m. every trading day, and KOFIA also distributes the information to KOSCOM and other information vendors.

4. Five-Year Korea Treasury Bonds Futures

a. Specification of 5-Year Korea Treasury Bonds Futures

Table 3.24 Specification of 5-Year Korea Treasury Bonds Futures

Item	Description
Underlying Asset	5-year Korea Treasury Bond with 5% coupon rate and semiannual coupon payment
Contract Size	W100 million
Contract Months	The first two consecutive months in the quarterly cycle(March, June, September, and December)
Trading Hours	09:00 a.m. to 3:15 p.m. (09:00 a.m. to 11:30 a.m. on the last trading day)
Tick Size and Value	0.01 point, representing a value of W10,000
Last Trading Day	Third Tuesday of the contract month
Final Settlement Day	The following day of the last trading day
Final Settlement	Cash
Position Limit	It can be adopted when the KRX deems necessary
Listing Date	22 August 2003

Source: Korea Exchange.

b. Underlying Basket Bonds for 5-Year Korea Treasury Bonds Futures

Table 3.25 Underlying Basket Bonds for 5-Year Korea Treasury Bonds Futures

Underlying basket bonds used to determine the final settlement price for KTB3 F 1203				
Issue Name	Code No.	Issue Date	Maturity	Coupon Rate
Treasury 0350-1609	KR1035017196	10 September 2011	10 September 2016	3.50%
Treasury 0400-1603	KR10350171399	10 March 2011	10 March 2016	4.00%

Underlying basket bonds used to determine the final settlement price for KTB3 F 1206				
Issue Name	Code No.	Issue Date	Maturity	Coupon Rate
Treasury 0350-1609	KR1035017196	10 September 2011	10 September 2016	3.50%
Treasury 0400-1603	KR10350171399	10 March 2011	10 March 2016	4.00%

Source: Korea Exchange.

5. Ten-Year Korea Treasury Bonds Futures

a. Specification of 10-Year Korea Treasury Bonds Futures

Table 3.26 Specification of 10-Year Korea Treasury Bonds Futures

Item	Description
Underlying Asset	10-Year Korea Treasury Bond with 5% coupon rate and semiannual coupon payment
Contract Size	W100 million
Contract Months	The first two consecutive months in the quarterly cycle(March, June, September and December)
Trading Hours	09:00 a.m. to 3:15 p.m. (09:00 a.m. to 11:30 a.m. on the last trading day)
Tick Size and Value	0.01 point, representing a value of W10,000
Last Trading Day	Third Tuesday of the contract month
Final Settlement Day	The following day of the last trading day
Final Settlement	Cash
Position Limit	5,000 contracts (contract month in which the last trading day belongs)
Listing Date	25 February 2008

Source: Korea Exchange.

b. Underlying Basket Bonds for 10-Year Korea Treasury Bonds Futures

Table 3.27 Underlying Basket Bonds for 10-Year Korea Treasury Bonds Futures

Underlying basket bonds used to determine the final settlement price for KTB3 F 1203				
Issue Name	Code No.	Issue Date	Maturity	Coupon Rate
Treasury 0425-2106	KR1035027161	10 June 2011	10 June 2021	4.25%
Treasury 0500-2006	KR1035027062	10 June 2010	10 June 2020	5.00%
Underlying basket bonds used to determine the final settlement price for KTB3 F 1206				
Issue Name	Code No.	Issue Date	Maturity	Coupon Rate
Treasury 0425-2106	KR1035027161	10 June 2011	10 June 2021	4.25%
Treasury 0500-2006	KR1035027062	10 June 2010	10 June 2020	5.00%

Source: Korea Exchange.

Among KTBs with a 6-month coupon payment, KRX has the discretion to select single or plural bonds which will be included in the basket and then used to compute the final settlement price. KOFIA sends KRX the yields for each individual bond in the basket, as of 11:30 a.m. and 3:30 p.m. every trading day and KOFIA also distributes the information to KOSCOM and other information vendors.

IV. Possible Impediments for the Realization of a Cross-Border Market

A. Tax-Related Issues

1. Withholding Tax on Interest Income

Republic of Korea withholds tax on interest income as a rule, with different rates applied depending on the investor's residency. For residents, a 15% withholding tax is levied on interest income from bonds. For nonresidents, a 10%–15% tax is levied for residents of countries with a tax treaty and a 25% tax is levied for residents of countries without a tax treaty.

Tax withholding on interest income affects the after-tax rate of return. Even if the host country does not withhold tax on interest income, foreign investors must pay tax in their home country. In addition, if the host country does levy withholding tax and if it exceeds the tax amount that foreigners have to pay to their home country, they can receive reimbursement for the difference. Accordingly, tax withholding does not necessarily lead to a lower after-tax rate of return. Nonetheless, the inconvenience arising from processing tax returns and adjusting tax based on the holding period make bond trading complicated. Thus, international bond investors, including bond funds that invest in bonds in different countries, tend to avoid countries where withholding tax is imposed.

For this reason, some countries, including developed countries, seek bond investments from foreigners by abolishing withholding tax or exempting nonresidents from withholding tax on interest income. The Working Group 2 organized under the Asian Bond Market Initiative (ABMI) recommended abolishing or lowering withholding tax on interest income for foreign investors to attract increased foreign investment in domestic bonds. Following this ABMI recommendation, Thailand and Malaysia abolished their respective withholding taxes on interest income for foreign investors. In January 2009, in the middle of the currency crisis caused by the global financial crisis, the Korean government decided to exempt nonresidents from withholding tax on interest income from all government bonds and monetary stability bonds (MSBs).

2. Re-Imposition of the Withholding Tax

However the government re-imposed a flexible tax (currently 14%) on interest income and a 20% tax on capital gains from Korean Treasury Bonds (KTBs) and MSBs held by foreign investors, effective 1 January 2011. This was made following the passage of legislative bills in December calling for the restoration of the withholding tax in order to mitigate capital flow volatility and minimize systemic risks to the domestic economy.

3. Responsible Authorities

The Ministry of Strategy and Finance (MOSF) has supervisory power over tax policy and administration. Within the ministry, the National Tax Service is responsible for enforcing tax laws and regulations.

Republic of Korea, taxes are levied at both the national and local levels. National taxes consist of internal taxes, customs duties and surtaxes. Internal taxes are further subdivided into direct and indirect taxes. Local municipalities administer local taxes and such taxes include general and specific taxes. Korean securities-related taxes consist of securities transaction taxes and income taxes. The securities transaction tax is considered an indirect tax, whereas the securities income tax is part of the direct tax category.²⁴

B. Disclosure and Investor Protection Rules for Issuers

1. Overview

Art. 1 of the 2009 *Financial Investment Services and Capital Markets Act* (FSCMA) stipulates that “the purpose of the Act is to contribute to the development of the national economy by facilitating financial innovation and fair competition in the capital market, protecting investors, enhancing the development of the financial investment business and heightening the fairness, reliability and efficiency of the capital market.”

When the financial assets of an ordinary investor are unfairly treated by a financial investment business entity or such an entity recommends financial investment instruments by providing misleading or false information that is not adequate for an ordinary investor considering their investment purpose, the investor will lose confidence in the capital market. As such, investor protection is crucial not only to protect the rights of investors as the consumers of the market, but also to promote the sound development of the capital market. Since many of the articles in FSCMA include investor protection, it is hard to detail all the relevant provisions governing investor protection; however this chapter will discuss the major provisions of FSCMA relating to investor protection.

2. Disclosure for Ordinary Investors

The term “disclosure” refers to the provision of information to general public so that anyone may have access to such information. Unlike institutional investors or other professional investors, ordinary investors are highly likely to be excluded from material information that may have a significant impact on the value of stocks and other

²⁴ ADB, 2010, *Bond Market in Japan and Korea*, Asian Development Bank, Philippines

financial investment vehicles. Therefore, such material information shall be disclosed to ensure fair-trading in the financial market. FSCMA stipulates a series of provisions concerning the matter.

The provisions of disclosure are related to investor protection in that the purpose of these provisions is to prevent damages being inflicted upon ordinary investors due to information asymmetry. Investors shall make reasonable and informed decisions based on such publicly disclosed information.

3. Disclosure of Financial Investment Business

Information on financial investment instruments and financial investment business entities is disclosed on the Korea Financial Investment Association (KOFIA) website (<http://www.kofia.or.kr>). KOFIA's electronic disclosure system posts information on financial investment instruments, financial investment business entities, and professional investors. Matters that a securities company must disclose include commission rates, management disclosure, ad hoc disclosure, and net capital ratio.

Commission rates are provided by the amount of trading and the methods of transaction (online or offline). Management disclosure includes information on any cases of litigation or restrictions relevant to the securities company.

The disclosed information can be utilized to assess the compliance of the company to the internal controlling policies for investor protection. A collective investment business discloses information on asset management companies and funds.

An asset management company provides periodic disclosures including closing accounts reports, periodic reports, and periodic management disclosure as well as ad hoc disclosures. A collective asset management entity shall submit an asset management report of funds at least once every three months, including the operating performance of funds, total amount of asset and liabilities of funds, the assessed value of each type of asset that belongs to the funds, the total number of stocks traded, total trading amount, turnover rate during the pertinent management period, matters concerning professional investment managers, and the fees for each investment broker.

Ad hoc disclosure for a fund and an asset management company includes the details described below. An asset management company shall immediately disclose the occurrence of any massive financial scandal or non-performing claims. Such information is material to assess the soundness of the company since any massive financial scandal or non-performing claim represents inadequate risk management or internal control systems within the company. Meanwhile, the ad hoc disclosure of funds provides information such as changes in fund managers, decisions on deferment or resumption of redemption and the reasons thereof, details of resolutions of the general meeting of collective investors, and details of a change in the base price.

The KOFIA website also posts information on professional managers including securities investment advisors, derivatives investment advisors, and fund investment advisors with their company names and business areas.

4. Disclosure in the Secondary Market

A listed company shall make periodic disclosures as well as ad hoc disclosures when it is deemed necessary. The information on a listed company is easily accessible on the website of Korea Exchange (KRX).

a. Periodic Disclosure

Periodic disclosure includes annual, semi-annual and quarterly reports. Anyone can have access to the information via the electronic disclosure system on the websites of KRX or Financial Supervisory Service (FSS). A listed corporation shall submit an annual report to Financial Supervisory Commission (FSC) and KRX within 90 days of the end of the business year. An annual report shall include an overview of the company, the trade name, details of its business, the remuneration of executives, matters concerning finance (financial statements), the accounting auditor's audit opinion, the organization of the company including the board of directors, shareholders, executives and employees, details of transactions with major shareholders, executives or employees of the company, and matters concerning investor protection. Such information is material to the selling or purchasing of stocks of the company and assessing the value of securities.

A semi-annual report is a six-monthly business report and a quarterly report is a three-monthly report calculated from the commencement date of the pertinent business year. A listed company shall submit the reports to FSC and KRX within 45 days of the closing of each term.

If any of the following events that may have a significant impact on the management of a company occur, the company shall submit a report on the details of the events to FSC by the following day from when such events occurred. The events include:

- i. a bill or check issued by the corporation is returned or its check account transactions in a bank are suspended or banned;
- ii. its business activities are completely or partially suspended; and
- iii. there is an application filed for commencement of proceedings for rehabilitation under the *Debtor Rehabilitation and Bankruptcy Act*.

A person who has acquired or disposed of securities issued by a corporation has the right to make a claim for damages caused by a false description or an omission of a material fact in a business report. The claim for damages can be made against the directors of the corporation, the person in charge of the business report, or the auditor.

In addition, when a business report has not been submitted, or a false description or an omission of a material fact exists, the FSC may suspend any securities issuance by the company for up to 1 year, file criminal complaints, or recommend the dismissal of executives.

b. Ad Hoc Disclosure

Ad hoc disclosure refers to reports that listed companies shall prepare without delay in order to immediately notify KRX of any material changes related to their business operations. KRX provides the disclosure requirements for the stock exchange and

KOSDAQ, respectively. Since the ad hoc disclosure typically contains the material information that may have a significant impact on the value of the company and the stocks, anyone may access such information through the KRX website.

Although the ad hoc disclosure includes a massive amount of information, it can be classified into three categories and KRX shall be notified of the following information by the following day from which such events have occurred.

First, matters that may have an impact on the operation or production of a listed company, such as a full or partial suspension of business operations that takes up 10% or more of the sales volume or any administrative measures thereof; the suspension of transactions that makes up 10% or more of sales; or the conclusion of contracts for product supply or sales.

Second, events that may change the financial structure of a listed company, for example the increase and reduction of capital, retirement of stocks, disposal of treasury stocks and stock splits that may have an impact on securities issued by a listed company; new facility investments that take up 10% or more of the equity that may have an impact on production; short-term borrowings that take up 10% or more of the equity that could have an impact on the credit or liability of the company; natural disasters that could have an impact on the profit and loss of a listed company by 5% or more at the year's end; and any decisions made on stock dividends.

Third, matters that may have an impact on the management of a listed company such as any changes in corporate governance due to changes in the largest shareholders; or litigation related to the company is brought to court, or a judgment on litigation is made.

Art. 392 of FSCMA prescribes that, in order to secure the effectiveness of disclosure, banks shall notify KRX of material information that is likely to affect investors' decision without delay; for example, where any issued bill or check defaults, or where any current account transaction with the bank is suspended or prohibited.

c. Fair Disclosure

Korea's securities market introduced the fair disclosure rule in November 2002. The rule requires that if a company discloses information to selective investors and it is deliberate, the company shall also provide such information to ordinary investors at the same time. When the disclosure is accidental, the company shall disclose such information to ordinary investors on the same day without delay.

The purpose of fair disclosure is to prevent insider trading and information asymmetry, and to allow more investors to receive the material information in a timely manner. The rule also aims to make the market fairer and more transparent and thereby enhances investor confidence. Fair disclosure is to supplement the ad hoc disclosure system and is implemented by KRX, a self-regulatory exchange. Detailed disclosure information is accessible on the website of the KRX website.

The information released in fair disclosure is different from that of periodic or ad hoc disclosures in that it pertains to expected data, such as business projection,

management projection, projection of sales, operating income or loss, net income or loss before tax from continuing operations, and net income or loss. Such information is material since it has a direct impact on stock prices, and if it were selectively disclosed only to institutional investors or analysts, individual investors would be disadvantaged when making investment decisions.

In this regard, fair disclosure is a regulation to protect ordinary investors.²⁵

C. Restriction for Qualified Institutional Investors in Private Placement

FSCMA in Chapter II stipulates the legal provisions on the restriction of investors. The legal provisions are as follows:²⁶

Section 1. Requirements and Procedure for Authorization

Article 11 (Prohibition against Business Activities without Authorization)

No one may engage in a financial investment business (excluding an investment advisory business and a discretionary investment business; hereafter the same shall apply in this Section) without authorization (including authorization for changes) for the financial investment business under this Act.

Article 12 (Authorization for Financial Investment Business)

- (1) An entity that wishes to engage in a financial investment business shall select all or part of its business units (hereafter referred to as “authorized business units”), as defined by Presidential Decree, by specifying the constituents enumerated in following subparagraphs, and shall obtain authorization for a single financial investment business from the Financial Services Commission: <Amended by Act No. 8863, Feb. 29, 2008>
 1. The type of financial investment business (referring to investment trading business, investment brokerage business, collective investment business, and trust business, and also including an underwriting business in the category of investment trading business);
 2. The rage (referring to the type of collective investment scheme under Article 229 in the case of a collective investment business, or referring to the trust property under subparagraphs of Article 103 (1) in the case of a trust business) of financial investment instruments (referring to securities, exchange-traded derivatives, and over-the-counter derivatives, including state bonds, corporate bonds, and other instruments specified by Presidential Decree in the category of securities, and also including derivatives based on underlying assets of stocks and other instruments as specified by Presidential Decree in the category of derivative); and
 3. The class of investors (referring to the classification of professional investors and ordinary investor; hereafter the same shall apply).

²⁵ Footnote 1, p. 281–287.

²⁶ Chapter II of the *Financial Investment Services and Capital Market Act*.

- (2) An entity that wishes to obtain authorization for a financial investment business under paragraph (1) shall satisfy all of the following requirements:
 1. An entity shall fall under any of the following items: Provided, That an investment brokerage business entity willing to run an electronic securities brokerage business under Article 78 shall be a stock company under the Commercial Act and a member of the Korea Exchange:
 - a. A stock company under the Commercial Act or one of the financial institutions specified by Presidential Decree; and
 - b. A foreign financial investment business entity (referring to a person who runs a business corresponding to a financial investment business in a foreign country in accordance with the Acts and subordinate statutes of the foreign country), who has installed a branch office or any other business consistent with the business it currently runs in the foreign country;
 2. An entity shall have its own equity capital equivalent to or more than the amount set by Presidential Decree, which shall be at least 500 million won for each authorized business unit;
 3. An entity's business plan shall be feasible and sound;
 4. An entity shall be equipped with human resources, an electronic computer system, and other physical facilities adequate for protecting investors and running a financial investment business in which it intends to engage;
 5. No executive may fall under any subparagraph of Article 24;
 6. The major shareholders or a foreign financial investment business entity shall meet all of the requirements set forth under the following categories:
 - a. In the case subparagraph 1 (a), its largest shareholder (including shareholders who are specially related persons of the largest shareholder; and where the largest shareholder is a corporation, persons who exercise de facto control over matters material to the management of the corporation, as specified further by Presidential Decree, shall be included herein) shall have adequate investing capabilities, good financial standing and social credibility; and
 - b. In the case of subparagraph 1 (b), the foreign financial investment business entity shall have adequate investing capabilities, good financial standing and social credibility; and
 7. An entity shall have a system for preventing conflicts of interest between the financial investment business entity and investors, as well as between a specific investor and other investors.
- (3) Further details necessary for fulfilling requirements for authorization under paragraph (2) shall be prescribed by Presidential Decree.

D. Registration Requirement for Foreign Investors

As the aforementioned in Sec. 2.04, foreign investors are required to register to FSS for participating in bond market. However, there is exemption from registration, which is as follows:²⁷

²⁷ Footnote 1, p. 235–236.

Foreign nationals, foreign-incorporated entities, or local branches of a foreign corporation engaging in business activities in Republic of Korea that qualify for “foreigner under national treatment” status, shall be exempt from registration upon submitting documents verifying their status. Registration will also be exempted in the case of acquiring stocks on the over-the-counter market for the purpose of “direct investment” as well as disposing of direct investments, but the details of the relevant transactions must be reported promptly to the FSS. Exemption from registration will also apply to cases where government bonds and market stabilization bonds are acquired and sold using “omnibus accounts” under the name of the International Central Securities Depository (ICSD) through an ICSD account.

E. Reporting Requirements for Non-Resident Trade Report and Foreign Exchange-Denominated Instruments

According to the *Detailed Rules of the Regulations on Financial Investment Business*, foreign investors or corporations and institutions related with securities trading for foreigners have an obligation to report.²⁸

F. Non-Resident Requirements

Based on Subparagraph 2 of Par. 1 of Art. 1 of *Income Tax Act (ITA)*, a person who holds an address in Korea or has held a temporary domicile in Korea for one or more years is referred to as a resident. Any foreign investor not meeting that definition is defined as a non-resident.

Therefore, according to this definition, a person who does not have an address or temporary domicile in Korea for one or more year is defined as a non-resident. The address in this context is determined by the objective facts of a living relationship, such as the existence of a family living together in Korea and of property located in Korea. The term domicile in this context means the place where a person has resided for a long time, besides their address, and in which there is no general living relationship, according to Par. 1 and 2 of Art. 1 of EDITA.

G. Restrictions on Over-the-Counter Transactions by Non-Residents

The KOFIA prohibits OTC transactions of listed securities between nonresidents. Nonresident investors can make transactions of listed securities through the KRX by making orders to the securities companies that are members of the KRX. If a non-resident investor wants to trade listed bonds OTC, the trade should be conducted through the intermediation of Korean securities companies. This regulation applies to almost all bonds issued in Korea since most publicly-issued domestic bonds are listed on the exchange market for tax purposes.

In many countries, bonds are generally traded in the OTC market. When foreign financial companies want to trade Korean bonds owned by them or their clients,

²⁸ Footnote 1, p.253.

they naturally try to find counterparties in the OTC market with whom terms can be negotiated. If a transaction in the OTC market has to be made through a Korean securities firm, it is possible that foreign investors will have to pay additional costs or lose the possibility of finding an advantageous trading opportunity. Such possibilities may keep foreign financial companies from investing in Korean bonds or recommending Korean bonds to their customers.²⁹

H. Credit Rating System and Its Relation to Regulations

Table 4.1 Overview of Credit Rating Framework and Governing Regulations

Items	Description
Introduction	- Credit rating for commercial papers and corporate bonds began in 1985 and 1986 respectively - Legal requirement for receiving two or more credit ratings for issuance of securities imposed in 1994
Development Path	- Government led development
Legal Framework	- Designation before 2001 - Licensing after 2001
Purpose of the Use of Credit Rating	- Oversight of the soundness of the financial institutions - Protection of investors
Regulations on the Use of Credit Rating	- Capital Market Consolidation Act and Regulation on Supervision of Banking Business
Barriers to Entry	- Licensing from the Financial Supervisory Commission
Regulations on Licensing and Associated Legal Definitions	- Use and Protection of Credit Information Act and its Enforcement Decree - Regulation on Supervision of Credit Information Business and Guidelines for Authorization or License of Credit Information Business
Perspective on Credit Rating Agencies	- Domestic regulations attach significance to the role of CRAs as offering of information.
Civil Liability	CRAs are subject to civil liability. - Article 750 of the Civil Act (Definition of Torts) - Articles 125, 127 and 162 of the Capital Market Consolidation Act - Article 40 of the Use and Protection of Credit Information Act * Criminal liability stipulated under Article 50 of the Use and Protection of Credit Information Act
Supervision and Regulation of Credit Rating Agencies	- Government led development of credit rating market à Emphasis placed on the need for supervision for the purpose of regulating domestic financial markets and protecting investors

Source: NICE.

I. The Use of Omnibus Accounts for Settlement

Foreigners who invest in Korean domestic bonds normally depend on local or global custodians to settle their transactions and keep the bonds they have acquired. In making settlement for securities transactions, custodians usually use omnibus accounts through which they consolidate all of their clients' transactions into a single account and make payments and deliveries using that account.

The foreign exchange regulation in Korea, however, requires that payments to settle securities transactions by foreigners must be processed through the individual account of each foreign investor. Since omnibus accounts for payments are not allowed for foreign investors, the custodian banks in charge of settling the bond transactions

²⁹ Footnote 26.

of foreign investors have to make payments through the individual account of each foreign investor. This leads to added costs and inconvenience.

Despite the higher costs and added inconvenience, foreign investors can still get settlement service for their transactions of Korean domestic bonds from local or global custodians. The real problem caused by the prohibition on the use of omnibus accounts lies with the fact that ICSDs, such as Euroclear and ClearStream, which usually provide settlement service for local bonds as well as international bonds, do not provide settlement service for local bonds of the countries where omnibus accounts are not allowed. Since ICSDs provide settlement services as well as depository services for bonds in many countries, international bond investors tend to use ICSDs to settle their international bond transactions. It is likely that these investors stay away from countries where ICSDs do not provide settlement services since investing in such countries requires the hiring of an additional custodian bank instead of relying upon the convenience of a single custodian taking care of all of their international transactions.

Prior to 2007, ICSDs did not provide settlement service for Korean bonds because the use of omnibus accounts by foreign investors was prohibited. As a consequence, it is plausible that Korea may have been losing potential foreign investments from those who would have invested in Korean bonds had they been able to settle their transactions through ICSDs. To address this shortcoming, the Korean government allowed ICSDs to use omnibus accounts to settle transactions of domestic bonds by foreign investors. The revised regulation stipulates that Clearstream and Euroclear can provide settlement services for the country's government bonds and MSBs through their omnibus accounts set up at the Korea Securities Depository (KSD).

Allowing omnibus accounts not only provides foreign investors with the benefit of lower cost and convenience in settlement, but also enables them to avoid significant institutional impediments. First, foreign investors do not have to register with the Financial Supervisory Service and get an investment registration certificate in advance if they settle their transactions of Korean domestic bonds through an ICSD. They can simply hold Korean domestic bonds at the representative omnibus account under the title of an ICSD.

In addition, the new regulation enables OTC transactions of Korean domestic bonds when these are deposited in and settled through the omnibus accounts of an ICSD. As a result, a foreign investor may now sell Korean government bonds to another foreign investor through a direct OTC transaction when both parties engage in the transaction via financial institutions that have settlement accounts at an ICSD.

Allowing ICSDs to make settlements using a representative omnibus account, however, may cause some problems in relation to the income tax exemption for foreigners. As was mentioned earlier, the Korean government decided to give foreign investors exemption from withholding tax on interest income from government bonds and MSBs in January 2009.

Since foreign investors no longer need an investment registration certificate if they settle their transactions through the omnibus account of an ICSD, a domestic investor

can easily disguise himself as a foreign investor by making settlement through an ICSD to gain a tax exemption on interest income.

Under this system, the settling members of ICSDs that acquire Qualified Financial Intermediary (QFI) status are allowed to make settlement of Korean domestic bond transactions for their customers through the omnibus accounts of ICSDs.

In order to qualify as a QFI, a financial institution is required to assess customer adequacy of foreign investors for tax exemption and keep track of the bond transactions and holding records of foreign investors so that they can report to Korea's National Tax Service as necessary.

In spite of the clear benefits, the use of omnibus accounts is an exception rather than a rule. It is only the ICSDs that are allowed to use omnibus accounts.

Therefore, foreign investors who do not settle their domestic bond transactions through ICSDs are still subject to restrictions such as registration requirements, prohibition of direct OTC transactions between foreign investors, and prohibition on the use of omnibus accounts.³⁰

J. Availability of Information in English

As Korean is used as the working language in domestic bond markets, there is a language barrier for foreign investors and traders. In addition, the supply of English-language documents on investment analyses of domestic bond markets for foreign investors is insufficient.³¹

K. Restrictions in Accounting Standard

FSCMA in Chapter III stipulates the legal provisions on Accounting. The legal provisions are as follows:³²

Article 32 (Accounting)

Each financial investment business entity shall comply with the following in accounting: <Amended by Act No. 8863, Feb. 29, 2008; Act No. 9407, 3 February 2009>

The fiscal year shall be the term specified by Ordinance of the Prime Minister for each type of financial investment business;

The propriety property of each financial investment business entity, the trust property, and other property of investors specified by Ordinance of the Prime Minister shall be clearly separated in accounting; and

³⁰ Footnote 26.

³¹ Footnote 26.

³² Chapter III of the *Financial Investment Services and Capital Market Act*.

A financial investment business entity shall follow the general accounting principles of financial investment and standards for accounting under Article 13 of the Act on External Audit of Stock Companies determined by the Financial Services Commission, and provided by public notice, after going through a resolution of the Securities and Futures Commission.

Matters not provided for in paragraph (1) in relation to the accounting of the proprietary property of a financial investment business entity, types of account titles and order of arrangement, and other necessary matters shall be determined by the Financial Services Commission, and provided by public notice. <Amended by Act No. 8863, Feb. 29, 2008>

L. Limited Opportunities to Utilize Bond Holdings

Bond investors in general make active use of their bond holdings to enhance returns from their investment. For instance, bonds can be used as collateral to cover counterparty risk in OTC derivative transactions.

They can be utilized for lending and borrowing transactions, as well as repo transactions. In Korea, however, such opportunities are quite limited because neither the inter-institution repo trading nor the lending and borrowing transactions of bonds are active. Moreover, there exists a limitation on the maximum amount of Korean won that foreigners can borrow through repo transactions or lending and borrowing transactions.

These restrictions deprive foreigners of the opportunity to enhance the returns from their investment in Korean bonds, rendering investment in Korean bonds less attractive.³³

M. Degree of Lack of Liquidity in the Secondary Market

Liquidity in the secondary market for bonds is relatively low in Korea, making investors in domestic bonds exposed to a higher liquidity risk. Various factors are responsible for the relatively low liquidity.

First, most large domestic investors, including pension funds and insurance companies, tend to be buy-and-hold investors.

Second, the market-making ability of bond dealers is quite limited. Finally, based on market convention, the minimum trading unit in the OTC market is set at W10 billion, which is extraordinarily high compared to minimums in other countries.³⁴

³³ Chapter II of the *Financial Investment Services and Capital Market Act*.

³⁴ Footnote 26.

V. Description of the Securities Settlement System

A. Existence of Uniform Legal Framework for All Types of Securities

The FSCMA on the securities aims to contribute to the development of the national capital market, protecting investors, rearing the development of financial investment business, and heightening the fairness, reliability, and efficiency of the capital market. In this Act, bonds are defined such as “debt securities” including local government bonds, special bonds, corporate bonds, corporate commercial papers, and other similar instruments.

B. Dematerialization or Immobilization versus Physical Securities

1. Dematerialized Securities

Securities which are not issued in paper form and whose ownership is held and is transferable by book-entry in a ledger is maintained by a central securities depository (CSD) or account management institution.

2. Immobilized Securities

Physical securities and non-certificated securities held and transferred by book-entry in a ledger maintained by a CSD or account management institution. See Table 8.3

C. Legal Ownership Structure of Dematerialized or Immobilized Securities

1. Dematerialized Securities

The ownership of dematerialized securities is held individually through an account opened at the CSD or account management institution.

2. Immobilized Securities

The method of holding the securities is same as dematerialized securities, but the ownership is not held individually, and is held collectively with a share in the joint ownership. That is, ownership of deposited securities is held in the form of indirect possession through the central depository (direct possessor) and account management institution (indirect possessor). See Table 8.3

D. Legal Ownership Transfer Mechanism

1. Dematerialized Securities

These are delivered by book-entry across the accounts of the transferor and transferee opened at the CSD or account management institution.

2. Immobilized Securities

The same method is used as dematerialized securities. However,

- a) the account structure of dematerialized and immobilized securities is explained based on the two-tier account structure.
- b) the form of ownership for dematerialized securities cites the common view in the academia of Japan, and the form of ownership for immobilized securities is explained in terms of the Korean deposit and settlement system.

E. Existence of a Central Securities Depository and Book-Entry System for Debt Instruments

Securities deposit is a process through which rights over securities are transferred, altered, and nullified by book-entry without the actual movement of physical certificates. To benefit from the securities deposit system, participants such as brokers or institutional investors have to open participant accounts at the CSDs and deposit their securities at the CSDs.

In Korea, the Korea Securities Depository (KSD) is the single CSD and provides securities deposit service.

1. The Deposit System

The securities deposit system consists of KSD as an operator, participants and their customers as users, and deposit-eligible securities as objects.

Securities holdings of participants are held in custody on a fungible basis at KSD and are settled on a book-entry basis by recording debit/credit on the account book, a legal ledger kept by KSD and its participants.

2. Benefits

a. Safe and Convenient Securities Transaction

When participants and their customers trade securities, they do not have to return their securities because KSD settles transactions by book entry without the physical movement of securities.

As a result of the securities deposit system provided by KSD, transactions of deposited securities are conducted in a safe and convenient way without the risk of loss and theft of physical securities and the burden of incidental expense.

b. Corporate Action Service

Participants and their customers who have deposited their securities at KSD do not have to withdraw securities to exercise their rights against issuing companies. KSD

provides corporate action services in relation with the deposited securities on behalf of them including dividends and principal and interest. Therefore, KSD participants and their customers can enjoy expedient and convenient corporate action services.

c. Comprehensive Securities Information Service

KSD participants and their customers can benefit from the comprehensive securities information service provided by KSD. KSD collects and manages all the information related to deposit-eligible securities. Issuance information, deposit information, lost and stolen securities, and corporate action information, to name a few.

F. Settlement System in Korea

The settlement system in Korea has developed in three major directions.

a. The Book-Entry System

The book-entry system was introduced as a protection measure against paperwork crisis, which refers to situations where the transfer of real securities or administration of reading slips arising from the sudden increase of securities trading cannot be dealt with. After the emergence of paperwork crisis, countries from around the world have tried to reduce inconveniences and risks that follow the transfer of real securities by depositing mainly securities at the CSD. Therefore, this system uses electronic methods for the transfer of securities by immobilizing securities or disposing of physical securities.

b. The Multilateral Net Settlement System

The multilateral net settlement system was introduced to reduce settlement charges and operational expenses. Compared with the gross base settlement system, this system reduces settlement funds and securities by approximately 90%. It also reduces an astonishing number of processed cases for settlement and has therefore established itself as a modern day settlement system.

For multilateral netting, trading data must be received and confirmed, and the deposit must be collected in order to guarantee settlement performance. After multilateral netting, instructions for the book entry exchange of securities and book entry transfers for charges are made to both the depositing organization and bank. Such duties have been carried out mainly by the clearing house.

c. The Central Counterparty System

The central counterparty (CCP) system was introduced to eliminate various legal risks. It refers to intervening between parties that trade in one more financial market. Through innovations, open offers, and debt assumption, the CCP becomes the buyer for all sellers and seller for all buyers.

Although the multilateral netting system greatly reduces settlement charges for market participants, if netting controls do not receive legal approval, netting settlement must be restored to the gross base settlement.

This incurs high liquidity and system risk in the market. Since problems for the legal effectiveness of multilateral netting arise from the lack of mutuality(1:1), each country tries to satisfy the requirements by initiating the CCP system to convert the transaction contract structure from a multilateral to 1:1 composition (Korea's civil law also stipulates an appropriation of 1:1). Since the CCP simultaneously possesses the status of a contracting party, performance of transaction contracts, that is, all authority and responsibilities related to settlement clearing, reverts to the CCP.

The traditional meaning (in a broad sense) of a settlement system is differentiated today into 'clearing system' and 'settlement system in a narrow sense'. The clearing system has merged the aforementioned second and third processes and has developed into a clearing institution (clearing house) with the CCP being the core concept.

The settlement system in a narrow sense is specialized by the CSD, which is in charge of book entry exchanges of securities, and the payment settlement system (central and commercial banks), which is responsible for the transfer of charges.

Korea's securities market has also developed by following this path. The CCP is operated in-house by the KRX, the book entry exchanges of securities is managed by the KSD, and the transfer of charges is handled by the BOK and commercial banks.

The FSCMA provides a clear definition of the role of the clearing house and settlement organization in the securities market. Under the law, KRX should play the role of a clearing house, and KSD should serve as the settlement organization.³⁵

G. Existence of Delivery versus Payment and Real-Time Gross Settlement Mechanism

1. Delivery versus Payment

The settlement of bond purchases in the over-the-counter (OTC) market is possible from the current business day, to the following business day (T+1), through to the 30th business day (T+30) under the agreement between the parties in the transaction. T+1 is most common. However, repo, retail bonds, and Money Market Fund(s) included bond transaction may be settled the same day.

Settlement of bonds in the OTC market is done by the delivery versus payment (DVP) of securities and payment, which aims to simultaneously deliver the bonds and settle the payment in order to increase the safety and efficiency of bond trading.

Introduced in November 1999, DVP involves simultaneous bond settlement, where remittance between the customer's account using the KSD's SAFE system and settlement using a BOK-Wire account takes place at the same time.

In other words, KSD sends the securities for sale to the purchasing institution's escrow account, while the purchasing institution orders BOK to remit the settlement to the selling institution through their current account at the KSD.

³⁵ Korea Exchange. <http://www.ksd.or.kr/eng/html/services/settlement.home>

The value of DVP in OTC trading of bonds in the first half of 2009 was W1,099 trillion, marking an approximately 42% increase year-on-year. By type, government bonds accounted for the largest portion of bonds remitted at W787 trillion (71.6% - including monetary stabilization bonds); financial bonds W173 trillion (15.7%). Other bonds, including special bonds and corporate bonds, totaled W139 trillion (12.7%).³⁶

H. Existence of Post-Trade Matching Mechanism

1. Reporting Duties of the Dealers

In order to facilitate price discovery and enhance post-trading transparency in the OTC market, the Korean government introduced the Bond Trade Report and Information System (B-TrIS) in 2000. Under this system, licensed bond dealers are required to report the specifics of each transaction to the Korea Financial Investment Association (KOFIA) through computer terminals within 15 minutes after the transaction has been conducted. KOFIA is then required to post the trading details.

Since the regulation allows exceptions to the 15-minute reporting requirement, however, a number of transactions in the OTC market are reported after 3:00 p.m. even if the transactions were conducted between 9:00 a.m. and 3:00 p.m.

2. Collection and Reporting of the Transactions Data

The transactions data, including the price and the trading volume in the KRX government bond market, are available on a real time basis to eligible participants. For transactions in the OTC market, KOFIA collects trading data reported by licensed bond dealers and reports them on the website on a real time basis. Trading data are also provided to various data vendors.³⁷

I. Existence of Execution Matching Mechanism

Clearing is the process of transmitting, reconciling and, in some cases, confirming payment orders or securities transfer instructions prior to settlement, possibly including the netting of instructions and the establishment of final positions for settlement. After netting, participants of securities market can have a final position, securities delivery or cash payment.

Trade reporting is the first step for settlement. An exchange and trading parties in the OTC market have to report their trades to the clearing house (CCP) or the CSD (KSD). Trade reporting is a very important process in an organized market because, after receiving trade reporting, a Clearing House interposes itself as counterparty and guarantees the completion of the whole trades.

The next process is trade comparison (matching). Comparison is the process of comparing the trade details to ensure that trading parties agree with respect to the

³⁶ Footnote 1, p. 154.

³⁷ Footnote 26.

terms of the transaction. It is done by clearing houses for exchange markets and by settlement organizations for OTC Markets.

The next step of clearing is netting. Netting is an agreed offsetting of position or obligation by trading partners or participants. Netting is the process of reducing multiple credit/account obligations among multiple traders to several credit/account obligations. Netting is classified into bilateral netting and multilateral netting by the numbers of trade parties. Bilateral netting is that both parties of transactions become the settlement counterparts and netting is carried out between two institutions. But, multilateral netting reduces a large number of individual positions or obligations to a small number of obligations or positions.

J. Settlement Scheme for Corporate Bonds, Government Bonds and Others (Gross-Gross, Gross-Net, Net-Net)

Settlement is the completion of a transaction, wherein the seller transfers securities or financial instruments to the buyer and the buyer transfers money to the seller. It is classified into DVP and free of payment (FOP) depending on connection and separation of delivery and payment.

The characteristic of DVP is to deliver and receive securities and funds at the same time. The characteristic of FOP is to deliver and receive securities and funds separately.

According to Bank for International Settlement (BIS), DVP model is divided into three types. First, **DVP1** is the settlement method which in every transaction, delivery and receipt of securities and funds occurs in the whole quantity standard. In short, DVP1 is the settlement method of settling on a trade by trade basis. In **DVP2**, securities delivery occurs in Gross amount of standard, as soon as seller's securities are fulfilled. But funds are netted at the end of processing cycle. In **DVP3**, securities and funds are settled by net basis occurring at the end of processing cycle. This model can economize the liquidity of securities and funds.

KRX provides clearing services as a CCP for stock market and. It also provides clearing and settlement services for the futures market. Meanwhile, KSD provides settlement services for cash market, like the stock market and KOSDAQ. Unlike the KRX Market, KSD provides clearing services as well as settlement services for FreeBond, stock's OTC market, and bond's OTC market. The settlement for stock OTC market and bond OTC market is called institutional settlement.

K. Settlement Cycle for Corporate Bonds, Government Bonds and Other Debt Securities

The settlement cycle is T+2 for stock transactions and KSD employs DVP Model 3 (Netting of Securities and Cash). Currently, KSD is providing settlement services for exchange transactions, institutional transactions, and OTC transactions.

1. Benefits

a. Low Cost-High Efficiency Back-Office Infrastructure Service

All the post-trade processes such as trade reporting, confirmation, settlement data production, and settlement result notification are processes through KSD, which has led to the automation and standardization of post-trade operations carried out by KSD.

As a result, KSD plays the role of the low cost-high-efficiency back-office infrastructure, sharply reducing the operational burden of KSD participants.

b. Settlement Obligation Reduction

Because of the net settlement system of KSD, settlement system participants can benefit from settlement obligation cut and risk reduction. For example, participants of the Bond Institutional Settlement System are enjoying, on average, a daily settlement liquidity reduction of about W5 trillion.

c. Credit Enhancement

The settlement system guarantees settlement finality. Therefore, brokers can trade with any counterparty regardless of his credibility. In other words, as settlement risk (counterparty risk) is removed by KSD, they can trade with any counterparty that they would like to trade with.³⁸

L. Brief History of the Development of the Securities Settlement Infrastructure

Table 5.1 Brief History of the Development of the Securities Settlement Infrastructure

Classification	Period	Settlement System
Early stage of modernization	1956–1967	Latter settlement system
Capital market development	1969–1978	The latter settlement system had shifted new regular-way system
Market liberalization	1979–1985	The securities deposit system was established to enhance effectiveness of the book-entry clearing system
Expansion of the capital market	1986–1995	The settlement of bonds traded between institutional investors was required to be carried out through wire transfer via the KSD in order to avoid risks and inefficiency in the settlement process.
Asian financial crisis and reform measures	1996–2003	The BOK-Wire with the book-entry system of KSD for DVP of the OTC bond transactions is introduced.
Enhanced competitiveness of the capital market	2004–2009	

Source: Korea Financial Investment Association. 2010 *Capital Market in Korea*.

Most bonds are traded in the OTC market. KSD operates the OTC bond market settlement system to process bond transactions traded on the OTC market.

DVP settlement of bonds and funds is conducted through real-time gross settlement (RTGS) during the business hours of the next business day after the trade date once the required bonds and funds have been secured.

³⁸ Korea Securities Depository. www.ksd.or.kr

KSD is not liable for failed trades that must be handled directly by the involved parties. Since November 1999, the BOK has linked BOK-Wire with the book-entry system of KSD for DVP of the OTC bond transactions and therefore eliminating principal risk in OTC bond transactions.

The OTC market operates efficiently because of the existence of a very well functioning clearance and settlement system operated by KSD with direct linked to BOK-Wire.

Table 5.2 Korea Securities Market Settlement System

	Government bonds	Ordinary Bonds
Participants	Banks and securities companies	Securities companies
Clearing house	KRX	
Settlement agency	KSD	
Settlement method	Multilateral netting	
Settlement date	T+1	T+0
DVP	Yes	Yes
Fund settlement	Via BOR-Wire	Via designated commercial banks
Securities Settlement	Book-Entry	Book-Entry
Source: Bank of Korea		

[The Korea Bond Market, the Next Frontier, p.68 published by the Korea Securities Dealer Association in June 2008; please refer to <http://www.voxeu.org/index.php?q=node/4060>]

M. Issues on Current Settlement Infrastructures

With relative higher quantity growth of Korean securities market, enhancement of the Securities Settlement System is being pursued for the stability and the competitive edge. KSD is now developing the new securities settlement system.

Table 5.3 Main Contents of the New Securities Settlement System

Category	AS-IS	TO-BE	Organizations
Stock Exchange Settlement	DVP3(DNS)	DVP3(CNS)	KSD, KRX
Institutional Settlement	DVP3	DVP2	KSD
Government Bond Settlement	DVP3	DVP1	KSD, KRX
Liquidity Provision	-	Intraday RP system	KSD, BOK
Stock Exchange Payment Settlement Bank	Shinhan Bank, Woori Bank	BOK	KSD, BOK
Source: Korea Securities Depository.			

N. Expected changes on settlement infrastructures

1. Enhancement of Efficiency in Securities Settlement

- a. (Stock exchange, Government bond) Through putting settlement beginning timing forward, try to increase speed of settlement

- b. (Stock exchange) By re-deducting settlement which is carried over through continuous net settlement (CNS), reduce settlement volume
- c. (Institutional settlement of stocks) In line with DVP2 method, reduce settlement amount by W1.2 trillion per day(Reduction by 64%)
- d. (Intraday RP) By providing liquidity required for government bond settlement, try to activate settlement

2. Enhancement of Safety of Securities Settlement

- a. (Stock exchange) By changing settlement bank into BOK, enhance safety of settlement
- b. (Institutional settlement of stocks) With introduction of CCP system, get rid of risks of non-performance of settlement
- c. (Government bond) Settlement in line with DVP1 after deduction will result in removal of risks
- d. (Intraday RP) Solve settlement concentration by providing liquidity required for government bond settlement

3. Scientific Settlement Risk Management

- a. (Stock exchange) Improve settlement risk management through management of collectable limit of securities
- b. (Institutional settlement of stocks) Remove advance settlement risk through net liability limit management and surplus value management, etc.

VI. Costs and Charging Methods

A. Registration Fee at the Central Securities Depository

Table 6.1 Fee Rates by Classification of Bond

Classification	Fee Rate
Domestic entity issuing bond	- W10 billion and less: W100,000 - W10 billion and more: Registration amount \times 1/100,000 (Ceiling: W500,000)
Foreign entity issuing bond	- W10 billion and less: 500,000 - W10 billion and more: Registration amount \times 5/100,000 (Ceiling: 10,000,000)
Source: Korea Securities Depository.	

B. Transfer Fee (Book-Transfer Fee) at the Central Securities Depository

A book-transfer fee of W1,000 per transaction levies on the transferor.

C. Average Ongoing Costs for Debt Instruments

Table 6.2 Maintenance Fee (Deposit Fee) at the Central Securities Depository
(monthly basis)

Range	Fee Rate
W1 trillion and less	W0.00125 per W10,000
Over W1 trillion up to W3 trillion	W125,000 + W0.001 per W10,000
Over W3 trillion	W325,000 + W0.00075 per W10,000
Source: Korea Securities Depository.	

Interest payment and/or redemption fee at the Central Securities Depository (CSD) are not applicable.

D. Market Charges

Brokerage commission is determined by each broker company. Normally, brokerage commission rates range as follows:

Table 6.3 Brokerage Commission

Security	Rate
Equities on KRX	0.4% – 0.5%
Equities in OTC	0.5%
Bonds in KRX	0.1% – 0.3%
Bonds in OTC	Nil

Source: Korea Securities Depository.

VII. Market Size and Statistics

A. Bonds Issued

Table 7.1 Bonds Issued (W billion)

Year	Treasury Bonds	National Housing Bonds	Industrial Finance Debentures	For. Exch. Sta. Fund Bonds
2001	21,830.1	5,439.6	9,631.7	3,600.1
2002	19,350.1	7,617.6	12,350.1	7,500.0
2003	34,520.0	7,090.3	13,964.9	7,800.0
2004	55,950.0	5,539.2	18,622.6	
2005	62,550.0	8,209.1	21,761.4	
2006	60,668.2	10,621.2	24,756.6	
2007	48,259.0	8,550.4	27,150.1	
2008	52,054.0	8,472.8	26,519.0	
2009	84,976.0	9,544.4	23,333.4	
2010	77,721.4	8,938.9	9,176.0	
Year	Monetary Stabilization Bonds	Seoul Metropolitan Subway Bonds	Corporate Bonds	Total
2001	78,033.5	482.8	87,194.9	206,212.7
2002	69,840.4	561.7	77,522.0	194,741.9
2003	91,735.0	549.2	61,757.6	217,417.0
2004	134,722.5	473.0	50,379.0	265,686.3
2005	165,125.3	545.6	48,103.0	306,294.4
2006	150,048.7	391.3	41,678.2	288,164.2
2007	156,690.0	553.0	45,259.8	286,462.3
2008	151,390.0	359.7	52,758.5	291,554.0
2009	375,460.0	633.4	84,208.1	578,155.3
2010	248,150.0	611.8	83,573.8	428,171.9

Source: Economic Statistics System, Bank of Korea.

B. Outstanding Amount of Bonds Issued

Table 7.2 Outstanding Amount of Bonds Issued (W billion)

Year	Treasury Bonds	National Housing Bonds	Industrial Finance Debentures	For. Exch. Sta. Fund Bonds
2001	50,919.0	20,645.0	24,383.9	8,699.9
2002	55,615.2	25,706.6	24,610.2	15,849.9
2003	81,483.3	30,050.6	25,232.4	23,649.9
2004	123,061.3	32,347.7	28,645.4	22,199.9
2005	170,475.2	37,086.0	30,744.7	15,300.0
2006	206,798.4	42,853.5	35,419.6	8,100.0
2007	227,373.3	43,336.9	41,604.1	3,000.0
2008	239,290.3	44,920.7	49,538.4	
2009	280,853.3	48,262.8	35,060.9	
2010	310,076.7	49,029.1	28,003.2	
Year	Monetary Stabilization Bonds	Seoul Metropolitan Subway Bonds	Corporate Bonds	Total
2001	79,121.3	3,057.4	154,400.4	341,226.9
2002	84,277.9	3,136.5	180,048.5	389,244.8
2003	105,496.7	2,945.4	187,355.9	456,214.2
2004	142,773.0	3,061.0	153,283.1	505,371.4
2005	155,235.0	3,319.5	142,549.6	554,710.0
2006	158,390.0	3,382.8	134,420.4	589,364.7
2007	150,340.0	3,457.1	135,663.6	604,775.0
2008	126,937.2	3,410.1	149,803.7	613,900.4
2009	149,237.2	3,520.7	188,748.7	705,683.6
2010	163,530.0	3,583.7	201,725.8	755,948.5

Source: Economic Statistics System, Bank of Korea.

C. Bond Trading Volume and Value (Over the Counter)

Table 7.3 Bonds Issued (W100 million)

Trading Date		Government	Municipal	Special	MSB	Bank	Other Financial	Corporate	ABS	Total
2012	Volume	821,761	4,366	91,373	617,245	186,613	46,872	62,330	12,973	1,843,532
	Value	843,999	4,114	92,999	619,013	184,623	47,314	63,046	13,075	1,868,183
	Contract	9,471	4,692	1,471	5,491	1,817	1,659	3,989	349	28,939
2011	Volume	31,486,143	117,355	2,403,340	15,956,478	4,856,646	940,007	1,753,851	275,443	57,789,264
	Value	32,202,136	111,581	2,437,617	16,022,653	4,853,266	951,173	1,771,071	277,178	58,626,676
	Contract	333,406	90,426	35,683	135,364	47,660	36,555	105,048	4,951	789,093
2010	Volume	31,510,281	143,899	2,244,644	13,935,147	5,554,625	764,515	1,368,993	181,444	55,703,548
	Value	32,413,217	135,575	2,280,063	14,032,922	5,568,539	778,720	1,392,164	182,700	56,783,899
	Contract	331,183	99,863	48,219	113,286	53,687	35,822	118,942	7,678	808,680
2009	Volume	21,660,552	136,198	2,031,982	10,700,265	4,914,948	561,695	1,249,880	219,329	41,474,850
	Value	22,216,735	125,303	2,057,037	10,778,689	4,945,600	570,930	1,262,461	221,393	42,178,149
	Contract	255,755	49,706	34,812	82,533	51,524	53,454	130,514	16,351	674,649
2008	Volume	12,517,635	93,791	1,233,733	8,941,243	4,304,773	355,323	583,334	135,963	28,165,796
	Value	12,619,115	86,353	1,234,308	8,939,350	4,271,178	355,609	580,605	138,971	28,225,489
	Contract	160,330	48,440	23,699	81,672	66,152	75,713	62,786	17,149	535,941

continued on next page

Table 7.3 continuation

Trading Date		Government	Municipal	Special	MSB	Bank	Other Financial	Corporate	ABS	Total
2007	Volume	11,732,450	71,292	609,938	7,650,093	2,649,135	263,880	517,138	167,291	23,661,218
	Value	11,692,788	65,473	608,232	7,651,597	2,626,304	264,409	516,641	176,975	23,602,418
	Contract	159,645	43,256	25,167	127,747	54,351	22,270	42,412	25,213	500,061
2006	Volume	16,496,779	76,927	699,720	9,153,818	2,912,707	300,428	677,148	319,352	30,636,878
	Value	16,563,813	69,589	702,018	9,089,381	2,879,561	302,387	679,145	325,413	30,611,308
	Contract	245,655	43,946	13,768	156,558	52,433	15,376	29,254	46,357	603,347
2005	Volume	18,849,444	75,148	845,051	10,266,213	2,256,637	297,401	785,981	436,766	33,812,641
	Value	18,808,631	69,885	852,262	10,185,561	2,226,617	301,524	791,275	460,964	33,696,719
	Contract	273,781	52,170	13,628	147,869	34,232	26,542	32,667	45,892	626,781
2004	Volume	16,067,582	60,978	983,227	8,621,678	2,235,317	471,721	917,967	498,574	29,857,044
	Value	16,411,212	58,974	1,001,053	8,567,177	2,204,685	475,751	926,649	523,690	30,169,189
	Contract	236,829	60,948	17,658	116,167	34,636	73,600	35,918	12,533	588,289
2003	Volume	10,394,804	63,158	1,280,154	9,148,202	2,403,334	677,163	809,360	848,770	25,624,944
	Value	10,533,114	64,460	1,315,162	9,117,833	2,353,265	685,531	812,929	877,341	25,759,634
	Contract	170,965	74,900	23,040	121,887	41,223	66,486	25,515	12,571	536,587
2002	Volume	7,574,527	61,916	1,334,249	7,769,542	2,071,386	1,113,120	989,664	1,248,497	22,162,902
	Value	7,617,011	58,380	1,379,313	7,723,625	2,017,727	1,143,083	990,716	1,278,718	22,208,573
	Contract	133,791	76,183	23,404	101,117	31,689	25,064	27,778	16,572	435,598
2001	Volume	9,804,344	82,470	4,944,284	8,554,052	926,085	991,852	1,572,787	1,062,971	27,938,845
	Value	10,043,899	82,173	5,076,428	8,552,186	907,539	1,027,099	1,562,848	1,080,313	28,332,484
	Contract	157,637	95,323	57,817	92,223	16,035	18,318	38,876	11,475	487,704

Source: KOFIA, www.kofiabond.or.kr

D. Bond Trading Volume and Value (Exchange)

Table 7.4 Bond Trading Volume and Value Exchange (W100 million)

Trading Date		Government	Municipal	Special	MSB	Bank	Other Financial	Corporate	ABS	Total
2012	Volume	330,395	2,637	137	7,752	450	362	2,128	93	343,955
	Value	334,193	2,427	152	7,778	466	367	2,086	93	347,564
	Contract	109,101	9,116	66	86	428	217	14,461	16	133,491
2011	Volume	7,831,068	51,794	9,437	100,390	4,205	8,436	50,548	1,107	8,056,985
	Value	7,933,176	46,954	9,792	100,976	4,396	8,557	50,832	1,118	8,155,800
	Contract	2,133,693	153,005	1,891	1,476	4,829	5,920	244,858	300	2,545,972
2010	Volume	5,327,595	129,430	7,457	108,709	2,178	7,140	34,672	1,027	5,618,208
	Value	5,361,062	115,700	7,640	109,556	2,223	7,274	35,358	1,036	5,639,848
	Contract	3,695,803	410,662	1,429	1,224	6,693	6,709	209,825	542	4,332,887
2009	Volume	4,790,002	36,500	6,775	20,158	4,183	6,356	35,571	383	4,899,929
	Value	4,865,171	31,061	6,872	20,207	4,330	6,472	34,602	387	4,969,101
	Contract	1,201,577	810,125	1,046	427	11,626	3,387	257,508	626	2,286,322
2008	Volume	3,552,035	45,629	6,216	16,341	16,871	8,223	10,541	426	3,656,283
	Value	3,542,380	38,044	6,248	16,437	16,748	8,206	10,965	428	3,639,456
	Contract	748,509	133,233	1,852	1,376	8,346	4,558	47,324	367	945,565
2007	Volume	3,097,075	32,721	1,697	13,478	13,514	1,897	13,366	987	3,174,735
	Value	3,062,881	27,802	1,697	13,467	13,443	1,895	15,358	989	3,137,531
	Contract	353,152	73,704	511	630	3,588	460	91,276	234	523,555

continued on next page

Table 7.4 continuation

Trading Date		Government	Municipal	Special	MSB	Bank	Other Financial	Corporate	ABS	Total
2006	Volume	2,881,670	36,026	956	5,770	2,076	2,351	11,477	1,556	2,941,883
	Value	2,881,607	30,989	948	5,771	2,089	2,370	12,534	1,560	2,937,868
	Contract	236,332	66,459	104	55	1,972	37	67,679	103	372,741
2005	Volume	3,592,633	44,420	6,830	1,437	2,162	83	18,004	413	3,665,982
	Value	3,570,152	38,736	6,116	1,438	2,182	84	18,938	412	3,638,058
	Contract	290,234	69,526	7,535	16	3,070	6	81,467	93	451,947
2004	Volume	3,692,373	58,425	10,604	1,504	753	21	11,088	60	3,774,827
	Value	3,766,561	52,527	9,842	1,506	769	20	9,807	60	3,841,092
	Contract	100,194	62,832	6,989	15	4,252	19	93,675	2	267,978
2003	Volume	2,087,181	25,611	2,567	800	128	50	10,069	0	2,126,406
	Value	2,117,452	23,718	2,497	802	116	50	8,989	0	2,153,624
	Contract	47,985	60,600	4,222	8	1,135	10	57,291	0	171,251
2002	Volume	433,056	23,607	1,917	800	116	109	19,362	0	478,967
	Value	437,812	20,327	1,685	805	0	111	33,007	0	493,746
	Contract	34,817	52,519	2,182	2	16	16	47,000	0	136,552
2001	Volume	104,448	13,147	835	0	0	232	20,416	0	139,079
	Value	109,357	11,989	779	0	0	355	20,805	0	143,285
	Contract	24,597	33,790	698	0	1	477	25,882	0	85,445

Source: KOFIA, www.kofiabond.or.kr

E. Statistics of Over-the-Counter Institutional Repo Market

Table 7.5 Trading Value and Balance (₩100 million)

Year	Trading Value ^a	Daily Average Balance
2010	9,645,590	109,665
2009	6,250,582	69,913
2008	4,641,507	40,386
2007	408,307	10,728
2006	74,681	13,789
2005	128,984	20,434
2004	139,516	22,308
2003	115,309	11,904
2002	103,476	8,805

^a including only start-leg settlement amount.

Source: KOFIA, www.kofiabond.or.kr

Table 7.6 Trading Volume of the Purchased Securities (₩ 100 million)

	Government Bonds	Monetary Stabilization Bonds	Other Bonds	ETF	Sum
2010	2,946,487	1,937,101	5,231,954	0.245	10,115,541
2009	2,337,577	747,075	3,439,124	–	6,523,776
2008	1,451,192	926,562	2,590,293	–	4,968,047
2007	85,366	158,168	186,799	–	430,333
2006	6,171	21,897	53,361	–	81,429
2005	10,715	20,028	118,327	–	149,070
2004	22,396	17,642	115,485	–	155,523

Source: KOFIA, www.kofiabond.or.kr

F. Size of Local Currency Bond Market in US Dollars

Table 7.7 Size of LCY Bond Market in USD (Local Sources) (\$ billion)

Date	Government	Corporate	Total
Mar-95	60.63	-	60.63
Jun-95	60.48	-	60.48
Sep-95	62.72	-	62.72
Dec-95	67.01	-	67.01
Mar-96	66.75	-	66.75
Jun-96	69.80	-	69.80
Sep-96	67.82	-	67.82
Dec-96	64.63	-	64.63
Mar-97	58.30	-	58.30
Jun-97	65.46	-	65.46
Sep-97	64.93	-	64.93
Dec-97	36.09	-	36.09
Mar-98	49.69	-	49.69
Jun-98	58.08	-	58.08
Sep-98	57.03	-	57.03
Dec-98	71.23	-	71.23
Mar-99	71.18	-	71.18
Jun-99	78.21	-	78.21
Sep-99	74.06	-	74.06
Dec-99	81.87	-	81.87
Mar-00	93.62	241.95	335.58
Jun-00	97.17	245.88	343.05
Sep-00	100.09	253.80	353.89
Dec-00	122.38	232.60	354.99
Mar-01	122.74	232.96	355.69
Jun-01	125.59	252.25	377.83
Sep-01	133.29	263.06	396.35
Dec-01	135.61	268.57	404.19
Mar-02	140.41	265.99	406.41
Jun-02	160.00	300.21	460.22
Sep-02	156.95	299.07	456.02
Dec-02	163.07	323.11	486.18
Mar-03	165.00	300.91	465.91
Jun-03	179.40	320.48	499.88
Sep-03	196.89	320.47	517.36
Dec-03	205.69	307.95	513.64
Mar-04	239.63	311.31	550.94
Jun-04	250.11	306.08	556.18
Sep-04	261.14	303.35	564.48
Dec-04	318.70	338.02	656.72
Mar-05	357.22	341.51	698.73
Jun-05	364.05	343.84	707.90
Sep-05	372.65	345.58	718.23
Dec-05	392.93	360.75	753.68

continued on next page

Table 7.7 continuation

Date	Government	Corporate	Total
Mar-06	425.20	381.02	806.21
Jun-06	453.84	412.87	866.71
Sep-06	469.95	421.08	891.04
Dec-06	480.63	441.17	921.80
Mar-07	486.79	464.28	951.07
Jun-07	506.68	495.93	1,002.61
Sep-07	507.80	522.95	1,030.75
Dec-07	498.32	529.06	1,027.38
Mar-08	476.85	520.31	997.16
Jun-08	455.75	513.67	969.43
Sep-08	382.32	458.42	840.74
Dec-08	368.46	448.24	816.70
Mar-09	360.35	426.96	787.31
Jun-09	414.26	485.89	900.15
Sep-09	458.69	540.39	999.08
Dec-09	444.10	572.15	1,016.25
Mar-10	490.03	604.63	1,094.66
Jun-10	457.44	571.05	1,028.49
Sep-10	495.86	625.79	1,121.65
Dec-10	492.20	656.94	1,149.15
Mar-11	524.27	687.20	1,211.48
Jun-11	546.51	727.24	1,273.75
Sep-11	501.17	677.88	1,179.05

Source: Asian Bonds Online. http://asianbondsonline.adb.org/korea/data/bondmarket.php?code=LCY_in_USD_Local

G. Size of LCY Bond Market in % of GDP

Table 7.8 Size of LCY Bond Market in % GDP (Local Sources) (% GDP, \$ billion)

Date	Government (in %GDP)	Corporate (in %GDP)	Total (in %GDP)	Government	Corporate	Total
Mar-95	12.8	0	12.8	60.63	-	60.63
Jun-95	12.0	0	12.0	60.48	-	60.48
Sep-95	12.1	0	12.1	62.72	-	62.72
Dec-95	12.6	0	12.6	67.01	-	67.01
Mar-96	12.3	0	12.3	66.75	-	66.75
Jun-96	12.9	0	12.9	69.80	-	69.80
Sep-96	12.4	0	12.4	67.82	-	67.82
Dec-96	11.8	0	11.8	64.63	-	64.63
Mar-97	11.1	0	11.1	58.3	-	58.30
Jun-97	12.1	0	12.1	65.46	-	65.46
Sep-97	12.0	0	12.0	64.93	-	64.93
Dec-97	11.4	0	11.4	36.09	-	36.09
Mar-98	13.4	0	13.4	49.69	-	49.69
Jun-98	15.6	0	15.6	58.08	-	58.08
Sep-98	15.6	0	15.6	57.03	-	57.03

continued on next page

Table 7.8 continuation

Date	Government (in %GDP)	Corporate (in %GDP)	Total (in %GDP)	Government	Corporate	Total
Dec-98	17.1	0	17.1	71.23	-	71.23
Mar-99	17.4	0	17.4	71.18	-	71.18
Jun-99	17.6	0	17.6	78.21	-	78.21
Sep-99	17.0	0	17.0	74.06	-	74.06
Dec-99	17.0	0	17.0	81.87	-	81.87
Mar-00	18.5	47.7	66.2	93.62	241.95	335.58
Jun-00	18.6	47.1	65.7	97.17	245.88	343.05
Sep-00	18.8	47.7	66.5	100.09	253.80	353.89
Dec-00	25.7	48.8	74.4	122.38	232.6	354.99
Mar-01	26.6	50.5	77.1	122.74	232.96	355.69
Jun-01	26.0	52.2	78.2	125.59	252.25	377.83
Sep-01	27.2	53.6	80.8	133.29	263.06	396.35
Dec-01	27.3	54.2	81.5	135.61	268.57	404.19
Mar-02	28.0	53.0	81.0	140.41	265.99	406.41
Jun-02	28.1	52.8	80.9	160.0	300.21	460.22
Sep-02	27.5	52.3	79.8	156.95	299.07	456.02
Dec-02	26.8	53.2	80.0	163.07	323.11	486.18
Mar-03	28.3	51.5	79.8	165.0	300.91	465.91
Jun-03	28.8	51.5	80.4	179.4	320.48	499.88
Sep-03	30.1	49.0	79.0	196.89	320.47	517.36
Dec-03	32.0	47.9	79.8	205.69	307.95	513.64
Mar-04	35.2	45.7	80.9	239.63	311.31	550.94
Jun-04	36.2	44.3	80.5	250.11	306.08	556.18
Sep-04	36.9	42.9	79.8	261.14	303.35	564.48
Dec-04	39.9	42.3	82.2	318.70	338.02	656.72
Mar-05	43.4	41.5	85.0	357.22	341.51	698.73
Jun-05	44.7	42.2	86.9	364.05	343.84	707.90
Sep-05	45.5	42.2	87.8	372.65	345.58	718.23
Dec-05	45.9	42.1	88.0	392.93	360.75	753.68
Mar-06	47.1	42.2	89.4	425.20	381.02	806.21
Jun-06	48.6	44.2	92.7	453.84	412.87	866.71
Sep-06	49.5	44.4	93.9	469.95	421.08	891.04
Dec-06	49.2	45.1	94.3	480.63	441.17	921.80
Mar-07	49.7	47.4	97.1	486.79	464.28	951.07
Jun-07	49.9	48.8	98.8	506.68	495.93	1,002.61
Sep-07	48.7	50.2	98.9	507.80	522.95	1,030.75
Dec-07	47.8	50.8	98.6	498.32	529.06	1,027.38
Mar-08	47.6	52.0	99.6	476.85	520.31	997.16
Jun-08	47.1	53.1	100.2	455.75	513.67	969.43
Sep-08	44.9	53.8	98.7	382.32	458.42	840.74
Dec-08	45.2	55.0	100.2	368.46	448.24	816.70
Mar-09	48.7	57.7	106.3	360.35	426.96	787.31
Jun-09	51.4	60.2	111.6	414.26	485.89	900.15
Sep-09	51.9	61.2	113.1	458.69	540.39	999.08
Dec-09	48.5	62.5	111.1	444.10	572.15	1,016.25

continued on next page

Table 7.8 continuation

Date	Government (in %GDP)	Corporate (in %GDP)	Total (in %GDP)	Government	Corporate	Total
Mar-10	50.7	62.5	113.2	490.03	604.63	1,094.66
Jun-10	49.7	62.1	111.8	457.44	571.05	1,028.49
Sep-10	49.3	62.2	111.6	495.86	625.79	1,121.65
Dec-10	47.3	63.1	110.3	492.20	656.94	1,149.15
Mar-11	48.2	63.2	111.4	524.27	687.20	1,211.48
Jun-11	48.3	64.3	112.6	546.51	727.24	1,273.75

Source: AsianBondsOnline. http://asianbondsonline.adb.org/korea/data/bondmarket.php?code=LCY_in_GDP_Local

H. Size of FCY Bond Market in % of GDP (BIS)

Table 7.9 FCY Bonds to GDP Ratio (\$ billion)

Date	as % of GDP	FCY Denominated Bonds	GDP
Dec-95	4.6	24.5	531.9
Dec-96	6.7	36.9	548.2
Dec-97	15.2	48.1	316.4
Dec-98	11.9	49.7	416.1
Dec-99	9.7	46.7	481.6
Dec-00	9.6	45.6	476.9
Dec-01	8.9	44.1	495.9
Dec-02	7.7	46.5	607.7
Dec-03	8.3	53.5	643.5
Mar-04	8.4	57.3	680.9
Jun-04	8.7	59.9	690.6
Sep-04	8.7	61.6	707.8
Dec-04	8.1	64.3	798.9
Mar-05	8.1	66.4	822.4
Jun-05	8.3	67.5	814.6
Sep-05	8.5	69.6	818.4
Dec-05	8.5	73.1	856.7
Mar-06	8.3	74.9	901.9
Jun-06	8.5	79.1	934.7
Sep-06	8.7	82.7	949.0
Dec-06	8.8	86.2	977.5
Mar-07	8.8	86.6	979.3
Jun-07	9.5	96.2	1,015.2
Sep-07	9.3	97.3	1,042.6
Dec-07	9.5	99.3	1,042.4
Mar-08	10.2	102.1	1,001.5
Jun-08	10.7	103.7	967.8
Sep-08	11.9	101.2	852.0
Dec-08	12.4	100.8	814.9
Mar-09	13.8	102.1	740.4
Jun-09	14.0	112.6	806.5
Sep-09	13.6	119.9	883.0
Dec-09	12.9	117.7	915.0

continued on next page

Table 7.9 continuation

Date	as % of GDP	FCY Denominated Bonds	GDP
Mar-10	12.3	118.5	967.3
Jun-10	13.0	120.0	919.8
Sep-10	12.7	127.8	1,005.3
Dec-10	12.7	132.1	1,041.6
Mar-11	12.9	140.1	1,087.8
Jun-11	12.7	144.1	1,131.4

Source: AsianBondsOnline. http://asianbondsonline.adb.org/korea/data/bondmarket.php?code=FCY_in_GDP

I. Size of FCY Bond Market in USD (Local Sources)

Table 7.10 FCY Bonds Outstanding (Local Sources) (\$ billion)

Date	Government	Banks and Financial Institutions	Other Corporates	Total FCY
Mar-00	18.27	15.33	18.81	52.41
Jun-00	17.56	14.20	19.19	50.95
Sep-00	16.99	12.55	19.96	49.50
Dec-00	16.34	12.81	19.96	49.11
Mar-01	16.13	12.29	19.91	48.32
Jun-01	15.55	11.07	20.87	47.48
Sep-01	14.68	9.43	21.49	45.60
Dec-01	15.68	9.16	22.09	46.93
Mar-02	14.36	8.19	23.56	46.11
Jun-02	14.00	8.96	24.07	47.03
Sep-02	13.73	8.86	25.14	47.73
Dec-02	13.61	11.60	25.91	51.11
Mar-03	13.61	11.65	25.70	50.96
Jun-03	13.9	12.55	25.12	51.58
Sep-03	15.24	13.67	25.51	54.42
Dec-03	14.91	14.62	25.36	54.89
Mar-04	15.51	17.19	25.64	58.33
Jun-04	15.12	17.33	27.92	60.37
Sep-04	16.16	17.85	28.14	62.14
Dec-04	15.93	18.85	27.64	62.43
Mar-05	16.85	20.57	27.64	65.06
Jun-05	16.90	20.92	28.80	66.62
Sep-05	17.74	21.21	29.60	68.55
Dec-05	19.31	21.56	31.12	71.99
Mar-06	19.62	23.02	30.87	73.52
Jun-06	19.69	25.30	31.92	76.90
Sep-06	20.04	26.87	33.37	80.27
Dec-06	20.78	27.98	33.58	82.33
Mar-07	20.79	30.38	31.10	82.27
Jun-07	22.07	36.60	32.21	90.88
Sep-07	22.22	39.79	31.34	93.35
Dec-07	22.59	41.42	32.51	96.51
Mar-08	23.39	41.76	34.92	100.07

continued on next page

Table 7.10 continuation

Date	Government	Banks and Financial Institutions	Other Corporates	Total FCY
Jun-08	20.54	44.00	37.40	101.95
Sep-08	19.54	43.80	39.12	102.46
Dec-08	18.65	40.68	39.09	98.43
Mar-09	20.20	42.14	39.32	101.66
Jun-09	22.87	47.40	41.43	111.69
Sep-09	21.82	50.66	44.73	117.21
Dec-09	21.86	52.15	45.89	119.90
Mar-10	20.81	52.25	44.88	117.94
Jun-10	19.95	53.20	47.19	120.35
Sep-10	19.97	56.09	47.04	123.10
Dec-10	20.86	57.13	51.43	129.42
Mar-11	21.70	58.85	51.89	132.43
Jun-11	21.38	58.68	53.31	133.37

Source: AsianBondsOnline. http://asianbondsonline.adb.org/korea/data/bondmarket.php?code=FCY_Bonds_Outstanding

J. Issuance Volume of LCY Bond Market in USD

Table 7.11 Issuance Volume of LCY Bond Market in USD (\$ billion)

Date	Government	Corporate	Total
Mar-95	21.3685	0	21.3685
Jun-95	12.0539	0	12.0539
Sep-95	12.5211	0	12.5211
Dec-95	18.0739	0	18.0739
Mar-96	16.1514	0	16.1514
Jun-96	13.9319	0	13.9319
Sep-96	7.6923	0	7.6923
Dec-96	14.9937	0	14.9937
Mar-97	11.1999	0	11.1999
Jun-97	17.1582	0	17.1582
Sep-97	5.1911	0	5.1911
Dec-97	9.2391	0	9.2391
Mar-98	57.2167	0	57.2167
Jun-98	109.4167	0	109.4167
Sep-98	78.0795	0	78.0795
Dec-98	34.8556	0	34.8556
Mar-99	19.1444	0	19.1444
Jun-99	11.2848	0	11.2848
Sep-99	8.0360	0	8.0360
Dec-99	35.5015	0	35.5015
Mar-00	49.3274	0	49.3274
Jun-00	21.1921	0	21.1921
Sep-00	15.7196	0	15.7196
Dec-00	18.0790	0	18.0790
Mar-01	26.8842	36.1346	63.0188

continued on next page

Table 7.11 continuation

Date	Government	Corporate	Total
Jun-01	18.5853	29.9402	48.5255
Sep-01	23.8562	31.9835	55.8397
Dec-01	18.5236	33.7431	52.2667
Mar-02	24.3905	23.9017	48.2922
Jun-02	26.3114	28.5287	54.8401
Sep-02	19.7602	22.4147	42.1749
Dec-02	18.2090	38.3449	56.5539
Mar-03	29.8130	20.5513	50.3643
Jun-03	25.6126	29.4787	55.0913
Sep-03	29.8057	24.9317	54.7373
Dec-03	38.2719	28.4699	66.7418
Mar-04	51.9361	22.8477	74.7838
Jun-04	38.8091	32.0122	70.8213
Sep-04	41.7127	27.7420	69.4547
Dec-04	61.1129	35.5648	96.6777
Mar-05	86.8622	28.9904	115.8526
Jun-05	52.7401	39.1762	91.9163
Sep-05	58.2147	34.8790	93.0937
Dec-05	54.0271	40.5181	94.5452
Mar-06	66.6303	40.7304	107.3607
Jun-06	62.7636	58.1568	120.9204
Sep-06	72.7083	41.5458	114.2541
Dec-06	57.4386	49.8023	107.2409
Mar-07	61.9453	55.8542	117.7994
Jun-07	60.7475	53.4278	114.1752
Sep-07	74.3211	55.5251	129.8463
Dec-07	62.8371	55.9958	118.8329
Mar-08	71.7022	41.2133	112.9155
Jun-08	54.5971	66.5530	121.1501
Sep-08	51.6464	45.8951	97.5415
Dec-08	38.3851	48.5073	86.8925
Mar-09	65.2926	56.2822	121.5748
Jun-09	117.2916	62.1825	179.4741
Sep-09	127.0526	56.4654	183.5180
Dec-09	89.8288	52.7283	142.5570
Mar-10	101.8717	63.2719	165.1436
Jun-10	82.8978	69.0244	151.9222
Sep-10	70.5639	71.3541	141.9181
Dec-10	42.2718	71.4183	113.6901
Mar-11	69.0742	66.7581	135.8324
Jun-11	82.5516	78.7608	161.3124
Sep-11	62.5343	65.8408	128.3750

Source: AsianBondsOnline. http://asianbondsonline.adb.org/korea/data/bondmarket.php?code=Issuance_Volume_LCY

K. Foreign Holdings in LCY Government Bonds

Table 7.12 Foreign Holdings in LCY Government Bonds (W billion)

Date	Foreign Holdings	Total	% of Total
Dec-02	257.6	197,617.3	0.13
Mar-03	368.6	200,927.1	0.18
Jun-03	358.7	208,827	0.17
Sep-03	360.4	204,582.4	0.18
Dec-03	549.7	209,945.5	0.26
Mar-04	1,050.3	225,748.6	0.47
Jun-04	879.4	230,716.9	0.38
Sep-04	848.5	242,566.8	0.35
Dec-04	1,063.9	254,596.6	0.42
Mar-05	907.4	264,998.0	0.34
Jun-05	1,171.7	282,842.6	0.41
Sep-05	1,389.9	279,836.5	0.50
Dec-05	1,392.4	282,773.8	0.49
Mar-06	2,067.2	291,869.2	0.71
Jun-06	2,827.9	303,090.5	0.93
Sep-06	3,003.3	311,293.4	0.96
Dec-06	3,866.9	312,261.2	1.24
Mar-07	5,377.3	318,965.8	1.69
Jun-07	7,133.3	323,446.3	2.21
Sep-07	16,379.7	322,568.2	5.08
Dec-07	25,278.7	323,564.8	7.81
Mar-08	27,699.5	336,912.0	8.22
Jun-08	29,674.6	341,889.5	8.68
Sep-08	23,759.4	328,759.8	7.23
Dec-08	21,721.7	358,145.0	6.07
Mar-09	19,610.2	368,041.3	5.33
Jun-09	21,857.2	380,109.3	5.75
Sep-09	26,251.1	400,957.0	6.55
Dec-09	29,248.6	420,280.7	6.96
Mar-10	33,303.1	452,747.7	7.36
Jun-10	39,946.7	458,967.7	8.70
Sep-10	45,715.5	489,992.4	9.33
Dec-10	47,617.4	483,404.2	9.85
Mar-11	50,569.8	498,935.9	10.14
Jun-11	56,350.1	517,216.5	10.89

Source: AsianBondsOnline.http://asianbondsonline.adb.org/korea/data/bondmarket.php?code=Foreign_Holdings

L. Trading Volume

Table 7.13 Trading Volume (\$ billion)

Year	Govt Bonds	Corp Bonds	Total
Mar-98	8.31	32.21	40.52
Jun-98	14.37	29.14	43.51
Sep-98	10.38	52.54	62.92
Dec-98	30.23	81.92	112.15
Mar-99	46.49	80.66	127.15
Jun-99	142.15	115.86	258.01
Sep-99	39.07	62.05	101.12
Dec-99	72.02	75.34	147.36
Mar-00	69.18	86.64	155.82
Jun-00	109.09	69.53	178.62
Sep-00	164.54	70.88	235.42
Dec-00	177.20	59.30	236.50
Mar-01	187.21	97.65	284.86
Jun-01	155.61	87.63	243.24
Sep-01	198.03	107.19	305.22
Dec-01	171.26	76.05	247.31
Mar-02	145.60	64.52	210.12
Jun-02	141.18	65.85	207.03
Sep-02	185.14	61.13	246.27
Dec-02	152.50	85.63	238.13
Mar-03	187.37	75.38	262.75
Jun-03	180.26	66.41	246.67
Sep-03	225.62	57.86	283.48
Dec-03	232.18	52.71	284.89
Mar-04	236.86	57.51	294.37
Jun-04	287.07	62.48	349.55
Sep-04	287.75	54.57	342.32
Dec-04	323.28	58.89	382.17
Mar-05	374.51	53.32	427.83
Jun-05	306.20	53.05	359.25
Sep-05	310.90	49.41	360.31
Dec-05	270.02	57.14	327.16
Mar-06	302.65	55.97	358.62
Jun-06	293.55	66.71	360.26
Sep-06	293.89	56.86	350.75
Dec-06	282.96	59.21	342.17
Mar-07	271.91	59.30	331.21
Jun-07	272.39	57.26	329.65
Sep-07	250.02	50.79	300.81
Dec-07	249.91	58.19	308.10
Mar-08	275.90	79.13	355.03
Jun-08	247.47	73.39	320.86
Sep-08	215.03	63.41	278.44
Dec-08	230.68	77.31	307.99

continued on next page

Table 7.13 continuation

Year	Govt Bonds	Corp Bonds	Total
Mar-09	249.34	98.46	347.80
Jun-09	322.84	86.44	409.28
Sep-09	370.08	85.53	455.61
Dec-09	398.29	90.77	489.06
Mar-10	480.59	121.87	602.46
Jun-10	392.30	58.82	451.12
Sep-10	586.20	151.97	738.17
Dec-10	575.41	118.61	694.02
Mar-11	500.72	122.01	622.73
Jun-11	623.05	125.51	748.56
Sep-11	648.73	108.69	757.42

Source: AsianBondsOnline. http://asianbondsonline.adb.org/korea/data/bondmarket.php?code=Trading_Volume

M. Domestic Financing Profile

Table 7.14 Domestic Financing Profile (\$ billion)

Date	Domestic Credit (% of Total)	Bonds (% of Total)	Equity (% of Total)	Domestic Credit	Bonds	Equity	Total
Dec-00	52.08	33.80	14.13	546.96	354.98	148.36	1,050.30
Dec-01	49.24	34.27	16.49	580.77	404.18	194.47	1,179.42
Dec-02	51.18	33.80	15.02	736.32	486.18	216.12	1,438.62
Dec-03	48.12	32.82	19.06	753.14	513.64	298.25	1,565.03
Dec-04	45.80	34.02	20.18	884.13	656.72	389.47	1,930.32
Dec-05	39.93	30.76	29.31	978.16	753.68	718.01	2,449.85
Dec-06	34.92	34.16	30.92	942.34	921.80	834.40	2,698.54
Mar-07	34.73	34.61	30.66	954.21	951.07	842.44	2,747.72
Jun-07	33.03	32.84	34.13	1,008.55	1,002.61	1,042.16	3,053.32
Sep-07	31.90	31.76	36.34	1,035.20	1,030.75	1,179.33	3,245.28
Dec-07	32.30	32.35	35.35	1,025.99	1,027.38	1,122.61	3,175.98
Mar-08	33.77	33.75	32.48	997.95	997.16	959.79	2,954.90
Jun-08	34.94	33.77	31.29	1,003.04	969.42	898.36	2,870.82
Sep-08	37.74	34.97	27.29	907.24	840.74	656.12	2,404.10
Dec-08	40.91	37.48	21.61	891.34	816.70	470.80	2,178.84
Mar-09	39.24	36.97	23.79	835.54	787.31	506.59	2,129.44
Jun-09	37.65	36.88	25.47	919.12	900.15	621.76	2,441.03
Sep-09	35.56	35.64	28.79	996.76	999.08	807.10	2,802.94
Dec-09	35.09	35.64	29.27	1,000.72	1,016.25	834.60	2,851.57
Mar-10	34.87	36.18	28.95	1,055.21	1,094.66	876.13	3,026.00
Jun-10	34.79	35.97	29.24	994.81	1,028.49	836.19	2,859.49
Sep-10	33.66	35.28	31.06	1,070.23	1,121.65	987.65	3,179.53
Dec-10	32.41	34.66	32.93	1,074.65	1,149.14	1,091.91	3,315.70
Mar-11	31.86	34.64	33.49	1,114.27	1,211.47	1,171.20	3,496.94
Jun-11	33.83	31.15	35.01	1,159.56	1,067.65	1,199.93	3,427.14

Source: AsianBondsOnline. http://asianbondsonline.adb.org/korea/data/bondmarket.php?code=Domestic_Financing_profile

VIII. Next Step

A. Group of 30 Compliance³⁹

The so-called G-30 Recommendations were originally conceived as the Group of Thirty's Standards on Securities Settlement Systems in 1989, detailing in a first of its kind report nine recommendations for efficient and effective securities markets and covering legal, structural and settlement process areas. The recommendations were subsequently reviewed and updated in 2001, under leadership of the Bank for International Settlements (BIS), and through the efforts of a Joint Task Force of the Committee On Payment and Settlement Systems (CPSS) and the Technical Committee of the International Organisation of Securities Commissions (IOSCO). Compliance with the G30 Recommendations in individual markets is often an integral part in securities industry participants' and intermediaries' due diligence process.

Table 8.1 Global Clearing and Settlement – A Plan of Action

	Recommendation	Implemented
1	Eliminate paper and automate communication, data capture, and enrichment.	No
2	Harmonize messaging standards and communication protocols.	No
3	Develop and implement reference data standards.	No
4	Synchronize timing between different clearing and settlement systems and associated payment and foreign exchange systems.	Yes
5	Automate and standardize institutional trade matching.	Yes
6	Expand the use of central counterparties.	No (Please see below note 1)
7	Permit securities lending and borrowing to expedite settlement.	Yes
8	Automate and standardize asset servicing processes, including corporate actions, tax relief arrangements, and restrictions on foreign ownership.	No
9	Ensure the financial integrity of providers of clearing and settlement services.	No
10	Reinforce the risk management practices of users of clearing and settlement service providers.	No
11	Ensure final. Simultaneous transfer and availability of assets.	Yes

continued on next page

³⁹ Group of 30 (G30). 2003. *Global Clearing and Settlement – A Plan of Action*. <http://www.partad.ru/wrld/word/g30app1.pdf>

Table 8.1 continuation

	Recommendation	Implemented
12	Ensure effective business continuity and disaster recovery planning.	No
13	Address the possibility of failure of a systematically important institution.	No
14	Strengthen assessment of the enforceability of contracts.	No
15	Advance legal certainty over rights to securities, cash, or collateral.	Yes
16	Recognize and support improved valuation methodologies and closeout netting arrangements.	No
17	Ensure appointment of appropriately experienced and senior board members (of the boards of securities clearing and settlement infrastructure providers).	Yes
18	Promote fair access to securities clearing and settlement networks.	Yes
19	Ensure equitable and effective attention to stakeholder interests.	No
20	Encourage consistent regulation and oversight of securities clearing and settlement service providers.	Yes

Source: Group of 30 (G30), 2003. *Global Clearing and Settlement – A Plan of Action*.

B. Group of Experts Final Report: Summary of Barriers Market Assessment – Korea (April/2010)

The GoE Report refers to the published results in 2010 of the Group of Experts (GoE) formed under Task Force 4 of the Asian Bond Market Initiative (ABMI). In the report, published under the leadership of the Asian Development Bank (ADB), a group of securities market experts from the private and public sector in ASEAN+3, as well as International Experts, assessed the ASEAN+3 securities markets on potential market barriers, the costs for cross-border bond transactions, and the feasibility for the establishment of a Regional Settlement Intermediary (RSI). The findings in the GoE Report lead to the creation of ABMF.

Table 8.2 Summary of Barriers Market Assessment – Korea (April 2010)

Potential Barrier Area	Current Situation	Market Assessment Questionnaire Scores	Overall Barrier Assessment
Quotas	Foreign investors have access to all fixed-income instruments, and there is no ownership limit for foreigners.	OK	OK
Investor registration	Foreign investors must obtain an investment registration certificate (IRC) prior to investing in Korea. The IRC contains a unique identification number, which notes the foreign investor's nationality and other information. The IRC number is used in all trading, settlement and registration activities. Foreign investors may apply for a single IRC covering both equities and bonds. The requirements are well defined and do not appear onerous - e.g., only one document needs notarisation. We are told that IRC can be issued 1 day after submission. However, there is an investor perception of difficulties in this area. Appears to be some controversy over 'parent child' area regarding splitting or consolidating holdings over a number of sub-funds. Perception gap - there appears to be a perception among many investors that registration requirements are onerous.	LOW	LOW
FX controls - conversion	Since December 2007, foreign investors are allowed to buy the Korean won without any underlying securities trade. Perception gap - there appears to be a perception among many investors that foreign exchange (FX) controls are still in place.	OK	OK

continued on next page

Table 8.2 continuation

Potential Barrier Area	Current Situation	Market Assessment Questionnaire Scores	Overall Barrier Assessment
FX controls - repatriation of funds	There is no restriction on the repatriation of income or proceeds from the sale of securities. Sales proceeds converted into foreign currency can either be remitted overseas or held in onshore foreign currency accounts.	OK	OK
Cash controls - credit balances	Foreign investors can buy an unlimited amount of Korean won, keep it as cash, fund a purchase trade or re-convert back into FCY.	OK	OK
Cash controls - overdrafts	Sales proceeds can be used to fund purchase trades having the same settlement date. In theory, foreign investors can borrow up to KRW 1 billion without any restriction, and up to W30 billion with prior notification to the central bank. However, banks are not allowed to lend to foreign investors for a "speculative" purpose in securities, which is not clearly defined, and hence in practice overdrafts are not provided. There is a current proposal to the National Assembly to lift this restriction.	LOW	LOW
Taxes	The default tax rate to foreign investors is 22% on cash balance interest and dividends and 15.4% on interest income on debt securities. The rates of withholding tax and CGT may be reduced under applicable double taxation agreements, subject to documentation. Historical information is needed to calculate the tax. There are no officially recognised tax reclaim procedures. Taxes may be reclaimed on a case by case basis, although the reclaim is not guaranteed. There is a perception among foreign investors that tax is high. This appears to be incorrect and may reflect previous higher rates. The government has proposed that foreign investors will be exempt from interest and capital gains tax for income from government bonds and monetary stabilisation bonds.	LOW	HIGH
Omnibus accounts	Omnibus accounts in general are not permitted. However, as from 1 January 2008, omnibus accounts in the name of ICSDs at KSD are permitted for foreign investors buying and selling Korean government bonds and monetary stabilization bonds. Accounts must be held on an individual basis at the sub-custodian, with the global custodian designation. Due to tax and other restrictions, ICSDs have been slow to open links although these have now been announced. The government is currently reviewing the rules to allow omnibus accounts to be introduced later this year.	HIGH	HIGH
Settlement cycle	The settlement cycle for bonds is: T+1(or by agreement).	OK	OK
Message formats	KSD, and most local market participants, use SWIFT message formats. KSD uses SWIFT for both settlement and corporate event messages.	OK	OK
Securities numbering	ISIN codes are available for all local bond issues, and are available at the time of issue. ISIN can be allocated at any time through the online allocating system of the KRX. KSD, and most local market participants, use ISIN.	OK	OK
Matching	There is no trade matching or pre-settlement matching system for bonds.	LOW	LOW
Dematerialisation	Almost all bonds are dematerialised, or immobilised at KSD.	OK	OK
Regulatory framework	The regulatory regime is regarded as stable and consistent although some investors mentioned high penalties for non-compliance, and that local custodians take a very cautious view. It is clear that the Korean government is making serious efforts to attract foreign investors.	-	OK

Source: Group of Experts (GoE) Final Report: Summary of Barriers Market Assessment – Korea (April 2010). [https://wpqr1.adb.org/LotusQuicker/asean3goe/Main.nsf/h_58E34A1388F9070B48257729000C0A4E90F408746827C16248257729000C1334/\\$file/Part3.pdf](https://wpqr1.adb.org/LotusQuicker/asean3goe/Main.nsf/h_58E34A1388F9070B48257729000C0A4E90F408746827C16248257729000C1334/$file/Part3.pdf)

C. Revision of the *Commercial Act* and Corporate Bond Effective 2012

1. Revisions to the *Commercial Act*

The *Commercial Act* was substantially revised recently, and the corporate bond market is facing important regulatory changes.⁴⁰ The revised bill includes several modifications related to corporate bonds. It provides a foundation that enables diversified types of bonds to be issued by: repealing restrictions on subscription and the total amount of bonds; introducing the indenture trustee system for investor protection; and modifying the issue procedure to ensure investor protection. Overall, this new version of the bill reflects various demands to improve the corporate bond system, and therefore it may bring about tremendous changes to the corporate bond market in Korea.

First, the revision provides an environment where diversified types of bonds can be issued. The current *Commercial Act* adopts a positive system for securities, under which only the types of securities stipulated by law can be issued, and permits only three types of corporate bonds: ordinary corporate bonds, bonds with warrant, and convertible bonds. The lack of variety has limited the innovative use of securities by companies. The revision paves the way for issues of diversified corporate bonds, i.e., corporate bonds that pay out dividends by the resolution of the board of directors; bonds that can be redeemed with, or converted to other stocks or securities; and bonds whose redemption or payments are linked to the value of other securities, currencies, or other assets and indexes that the Presidential Decree stipulates according to a pre-determined method.

In addition, the new bill allows the board of directors to entrust its bond-issuing authority to the president of a company. In order to prevent the abuse of power, the period of entrusting should be less than one year, and the board of directors still holds the power to determine the amount and types of bond issues. Furthermore, the revision repealed several corporate bond regulations: the limitation on the total amount of corporate bonds, restrictions on offering of new bonds, and restrictions on redemption in excess par value.

Currently, the *Commercial Act* stipulates that “the total amount of bonds shall not exceed four times the amount of net assets of the company as shown by the latest balance sheet.” However, this article has been criticized as ineffective in protecting creditors because the issuer could borrow from elsewhere or decrease its capital after the issue. Rather than protecting creditors, this article limits the company’s opportunity for financing through corporate bond issues. In response to the criticism, the new bill repealed the limit on the total amount of corporate bonds in attempt to expand a company’s financing opportunity.

Another change in this area is the restrictions on offerings of new bonds. The current law says that “a company shall not offer new bonds for subscription until the amount of bonds previously subscribed has been fully paid,” but this article was removed.

⁴⁰ The National Assembly passed the revised bill in March 2011. The revision was published on 14 April 2011, and it will take effect from 15 April 2012.

Also important in this revision is the introduction of an indenture trustee system that is expected to enhance investor protection. Under the current Commercial Act, a commissioned company, which has been commissioned to offer bonds for subscription, undertakes dual duties: Serving the interest of the issuer during the subscription, but standing on the side of bondholders to protect their interest after the issue. However, this will change if the updated bill takes effect and the sole purpose of the trustee will be to protect the creditors' rights. The revision establishes new articles governing the qualification, duties, and responsibilities of trustees. However, an issuer is not obligated to appoint a trustee because doing so will incur huge costs. Those who share a special interest with the issuer or underwriter and those disqualified according to the Presidential Decree cannot act as a trustee. Only banks, trust companies, and others permitted by the Presidential Decree can become a trustee. The trustees should manage bonds with honesty and sincerity, and take on a fiduciary duty for bondholders as the updated bill stipulates. If a trustee violates the Commercial Act or goes against the resolution by the meetings of bondholders, the trustee faces a collective liability for damages.

Also added in the revision is the regulation about the authority, resignation, removal of the trustee, and the successor to the trustee. Last, the updated passage includes modifications on articles related to the bondholders' meetings, such as meeting procedures, voting rights, and how to exercise voting rights.

2. Impact of the Revision

The aforementioned changes in the *Commercial Act* are predicted to significantly address many problems related to corporate bonds. If the revision comes into effect, companies are expected to issue bonds more freely, and creditors will be able to enjoy better protection. There are good reasons for the high hopes.

First, the revision provides a basis for corporate bonds diversity. This should resolve the discrepancy in concept about securities between the *Commercial Act* and the Financial Investment Services and Capital Markets Act (FSCMA). While the former adopts a positive system to define securities, the latter uses a negative system that allows the issue of any new and innovative securities unless prohibited explicitly by law.

Under the previous circumstances, there was a lingering controversy whether any new securities permitted under the FSCMA fell under the categories of corporate bonds as defined in the *Commercial Act* or not. The updated bill adopts a wider definition for corporate bonds, and it creates a legal basis on which diversified securities can be issued. This will put an end to the controversy.

Second, as the limit on the total amount of issues is removed, companies should be able to finance themselves more flexibly. This will facilitate the introduction of bonds with new structures. Under the new law, companies will be able to issue diversified bonds tailored to their needs, and the volume of issue will be determined by market discipline.

Third, the revision paves the way for a system that substantially enhances the bondholders' interest. This will improve the international compatibility of corporate bond issues and enhance investor protection.

When a commissioned company protects the issuer during the subscription and works for bondholders after the issue procedure, bond holders are not fully protected. For example, if the issuer goes bankrupt, the commissioned company can only play a limited role in protecting bondholders. This gives rise to investor protection problems, and many other problems, such as undermining the credibility of corporate bonds. In order to tackle these matters, the revised Commercial Act introduces the concept of trustees, whose role is separated from the commissioned company.

Also, the updated bill adds new articles regarding the qualification and trustee’s duties. This is meaningful because it creates a foundation that can substantially enhance bondholder protection. Certain limits, however, exist because the appointment of a trustee is not mandatory under the revision.

Table 8.3 Question and Answer related to the New Commercial Act Scripless Provisions
(Answered by KSD)

<p>Invite opinion from KSD on how new Commercial Act scripless provisions may/will influence physical certificates, for our future outlook?</p>	<p>(Application scope) In the amended Commercial Act, the electronic registration system covers securities under the Commercial Act, such as stocks, corporate bonds, warrants, and commercial securities. It is not applicable to other securities under the Financial Investment Services and Capital Markets Act such as government bonds, municipal bonds, special bonds, CDs, beneficiary securities (collective investment securities) and depositary receipts.</p> <p>(Application method) The Commercial Act is a general law, so adopting electronic registration is decided by the issuer (by amendment to the Articles of Incorporation). Therefore, the issuer will be able issue physical securities, unless electronic registration is made mandatory by the Listing Regulations of the Korea Exchange.</p> <p>(Effect of electronic registration to paper securities) The revised law delegates the particulars of the electronic registration to the enactment decree, but it seems that legislating a separate special law will be inevitable in order to implement the system. In case a separate special law pursuant to the amended Commercial Act is enacted, it will be possible to execute the electronic registration system, which implementation will bring benefits such as reduced securities issuance costs, causing electronic registration to replace physical securities.</p>
<p>Source: Korea Securities Depository.</p>	

D. Commissioned Company System for Bondholders

Korea revised the Commercial Act and introduced the commissioned company system for bondholders to increase investor protection and advance the corporate bond market. The amendment makes the use of a trustee voluntary. However, to develop the corporate bond market, Korea needs to make commissioned company system mandatory and resolve the conflict of interest problem. A strategic approach is required because the use of commissioned company may increase financing costs and thereby hinder corporate bond issues.

Market participants should explore ways to customize the trustee system for the Korean capital markets. Under the revised Commercial Act, only banks, trust companies, and others permitted by the Presidential Decree can become commissioned companies. Also, those who share a special interest with the issuer or underwriter and those disqualified according to the Presidential Decree cannot become trustees. However,

the most important qualification factor should be the problem on conflict of interest. Just as in the US, the roles, rights, and duties of a trustee should be different before and after default.

In order for the revised Commercial Act to serve its purpose of revitalizing the corporate bond market, it is important to devise a system that helps create a safe investment environment for investors, and a convenient system for issuers. Before the revision goes into effect, financial institutions, issuers, investors, academics, legal professionals, and other market participants should discuss the trustee system to facilitate Korea's corporate bond market.

E. Bankruptcy Procedures

“The Asia-Pacific Restructuring and Insolvency Guide 2006” provides a guide to explain the restructuring and insolvency frameworks of Asia-Pacific countries, which also contains the report on Korea.⁴¹

According to the report

On March 21 2005 the Korean government promulgated the Act on Rehabilitation and Bankruptcy of Debtors, also known as the Unified Insolvency Law, which will come into force on April 1 2006. The law consolidates the Corporate Reorganization Act, the Composition Act, the Bankruptcy Act and the Act on Rehabilitation of Individual Debtors in order to establish systematic procedures for the rehabilitation and liquidation of insolvent companies and individuals. In consolidating these statutes, the law abolishes the composition procedure and establishes a rehabilitation procedure which modifies and improves the previous reorganization procedure. As a result, the law provides for two corporate insolvency procedures: bankruptcy and rehabilitation. The Korean principles on bankruptcy were adopted from the German legal system, introduced to the Republic of Korea via Japan. The principles on rehabilitation were largely modeled on US federal law, such as Chapter 11 protections.

In June 1998 almost all Korean financial institutions entered into the Financial Institutions Arrangement for Facilitating Corporate Restructuring (known as the Master Workout Arrangement), introducing an informal workout system into the Korean insolvency regime. The Korean government subsequently enacted the Corporate Restructuring Promotion Act, which replaced the Master Workout Arrangement with the aim of facilitating and expediting informal workouts. The act, effective from September 2001 until the end of 2005, is the basic law governing out-of-court, informal corporate rescue procedures. However, there has been some debate as to its constitutionality, which is currently under review by the Constitutional Court. Depending on the court's decision, the Korean government is considering amending the act to extend its effectiveness.

⁴¹ Asian Development Bank. 2006. *The Asia-Pacific Restructuring and Insolvency Guide 2006*. <http://www.adb.org/Documents/Guidelines/restructuring-insolvency/restructuring-insolvency.pdf>

The number of insolvency cases, both formal and informal, has soared since 1997, leading to growth in the domestic distressed claims business.

Moreover, workouts are more popular than corporate reorganizations. Since the introduction of the Master Workout Arrangement, a total of 83 insolvent companies have been subject to workouts. While most of the blue-chip companies involved in workouts have successfully completed the procedure, the process is still ongoing for those in declining industries or industries requiring heavy equipment and installations.

As a response to difficulties in reaching agreement between creditors and a lack of professionalism in the management of insolvent companies, the government introduced the corporate restructuring vehicle in October 2000.

However, this has not yet been utilized as an effective restructuring vehicle.

The corporate restructuring company was also introduced in May 1999 to promote corporate restructuring of insolvent companies and to address financial institutions' non-performing loans. The primary role of the corporate restructuring company is to obtain managerial control of an insolvent company and enhance its corporate value through vigorous restructuring. The insolvent company is eventually sold, within eight years of the date of acquisition, in order for the corporate restructuring company to realize capital gains.

Appendixes

Appendix 1.1 Financial Investment Service and Capital Market Act

FSCMA	
(Article 9) Other Definitions	<p>(7) The term “public offering” in this Act means the invitation of 50 or more investors, as computed by a formula prescribed by Presidential Decree, to make offers to acquire securities newly issued.</p> <p>(9) The term “public sale” in this Act means offering 50 or more investors, as computed by a formula prescribed by Presidential Decree, to make an offer to sell or invite offers to purchase securities already issued.</p>
ENFORCEMENT DECREE OF FSCMA	
(Article 11) Public Offering and Public Sale of Securities	<p>(1) In calculating fifty persons in accordance with Article 9 (7) or (9) of the Act, the number of persons who have been invited to subscribe securities of the same class as the securities in the instant case in any manner other than by public offering or public sale within six months before the public invitation to subscribe shall be aggregated, but persons falling under any of the following subparagraphs shall be excluded there from:</p> <ol style="list-style-type: none"> 1. Professionals falling under any of the following items: <ol style="list-style-type: none"> (3) Persons under any provision of Article 10 (1) 1 through 4 (See below); (4) Persons specified and publicly notified by the Financial Services Commission among those falling under Article 10 (3) 12 or 13 (See below); (5) Accounting firms under the Certified Public Accountant Act; (6) Credit rating business entities under the Use and Protection of Credit Information Act (hereinafter referred to as “credit rating business entities”); (7) Persons who provide accounting, consulting, and similar services to the issuer with an officially recognized qualification certificate for certified public accountant, appraiser, attorney-at-law, patent attorney, tax accountant, etc.; and (8) Other persons specified and publicly notified by the Financial Services Commission as professionals who are in a position to have good knowledge of financial status, business affairs, etc. of the issuer; and 2. Related persons falling under any of the following items: <ol style="list-style-type: none"> (a) The largest shareholder (referring to the largest shareholder under Article 9 (1) 1 of the Act; hereinafter the same shall apply) of the issuer and shareholders who hold 5/100 or more of the total number of outstanding stocks; (b) Executives (including those under subparagraphs of Article 401-2 (1) of the Commercial Act; hereafter the same shall apply in this subparagraph) of the issuer and members of the employee shareholders’ association under the Framework Act on Worker’s Welfare; (c) Affiliated companies of the issuer and their executives; (d) Shareholders of a stock-unlisted corporation (excluding a corporation that has a record of it as having publicly offered or sold its stocks), in cases where the issuer is the stock-unlisted corporation;

continued on next page

Appendix 1.1 continuation

ENFORCEMENT DECREE OF FSCMA	
	<p>(e) Executives and employees of a domestic affiliated company of the issuer, in cases where the issuer is a foreign enterprise established pursuant to laws and regulations of a foreign country, and sells stocks of the foreign enterprise to executives and employees of the domestic affiliated company in accordance with a stock option plan, etc. for improving welfare of employees;</p> <p>(f) Promoters of a company, if the company is being incorporated by the issuer; and</p> <p>(g) Other persons specified and publicly notified by the Financial Services Commission as related persons who are in a position to have good knowledge of financial status, business affairs, etc. of the issuer.</p> <p>(2) Even if the results of calculation under paragraph (1) shows that the number of persons who have been invited to subscribe is less than fifty persons and thus the invitation does not amount to a public offering of securities, it shall still be deemed as a public offering, in cases where it falls under the criteria prescribed and publicly notified by the Financial Services Commission for resale, taking into consideration the kind of securities, the characteristics of acquirers, etc.</p> <p>(3) In applying paragraph (1) to a public sale, the number of persons shall be calculated based on persons who are invited to subscribe outside of the securities market (excluding cases where a broker gets involved in trading listed stocks and securities depository receipts that are related to the stocks and that are listed on the securities exchange in accordance with Article 78 (1) of the Act).</p>
Article 10 (Scope of Professional Investors)	<p>(1) The term “professional investor specified by Presidential Decree” in the proviso to the main body of Article 9 (5) of the Act means a professional investor not falling under any of the following subparagraphs:</p> <ol style="list-style-type: none"> 1. State; 2. The Bank of Korea; 3. A person who falls under any provision of paragraph (2) 1 through 17; 4. A person who falls under any provision of paragraph (3) 1 through 11; <p>(2) The term “financial institutions specified by Presidential Decree” in Article 9 (5) 3 of the Act means any of the following financial institutions:</p> <ol style="list-style-type: none"> 1. Financial institutions under the Banking Act; 2. The Korea Development Bank under the Korea Development Bank Act; 3. The Industrial Bank of Korea under the Industrial Bank of Korea Act; 4. The Export-Import Bank of Korea under the Export-Import Bank of Korea Act; 5. The National Agricultural Cooperative Federation under the Agricultural Cooperatives Act; 6. The National Federation of Fisheries Cooperatives under the Fisheries Cooperatives Act; 7. Insurance companies under the Insurance Business Act (hereinafter referred to as “insurance companies”); 8. Financial investment business entities [excluding concurrently-run financial investment business entities under Article 22 of the Act (hereinafter referred to as “concurrently-run financial investment business entities”)]; 9. Securities finance companies with authorization under Article 324 (1) of the Act (hereinafter referred to as “securities finance companies”); 10. Merchant banks; 11. Financial brokerage companies with authorization under Article 355 (1) of the Act (hereinafter referred to as “financial brokerage companies”); 12. Financial holding companies under the Financial Holding Companies Act; 13. Specialized credit financial business entities under the Specialized Credit Financial Business Act; 14. Mutual savings banks under the Mutual Savings Banks Act and their Central Federation; 15. The Forestry Cooperatives Federation under the Forestry Cooperatives Act; 16. The Korean Federation of Community Credit Cooperatives under the Community Credit Cooperatives Act; 17. The National Credit Union Federation of Korea under the Credit Unions Act; <p>(3) The term “persons specified by Presidential Decree” in Article 9 (5) 5 of the Act means any of the following persons:</p> <ol style="list-style-type: none"> 1. The Korea Deposit Insurance Corporation and reorganized financial institutions under the Depositor Protection Act; 2. The Korea Asset Management Corporation under the Act on the Efficient disposition of Non-Performing Assets, etc. of Financial Institutions and the Establishment of Korea Asset Management Corporation; 3. The Korea Housing Finance Corporation under the Korea Housing Finance Corporation Act; 4. The Korea Investment Corporation under the Korea Investment Corporation Act; 5. The Association; 6. The Korea Securities Depository established pursuant to Article 294 of the Act (hereinafter referred to as the “Securities Depository”);

continued on next page

Appendix 1.1 continuation

ENFORCEMENT DECREE OF FSCMA	
	<p>7. The Korea Exchange established pursuant to Article 373 of the Act (hereinafter referred to as the "Exchange");8. The Financial Supervisory Service under the Act on the Establishment, etc. of Financial Services Commission (hereinafter referred to as the "Financial Supervisory Service");</p> <p>9. Collective investment schemes (excluding those specified and publicly notified by the Financial Services Commission);</p> <p>10. The Korea Credit Guarantee Fund under the Credit Guarantee Fund Act;</p> <p>11. The Korea Technology Credit Guarantee Fund under the Technology Credit Guarantee Fund Act;</p> <p>12. Funds established pursuant to a relevant Act (excluding those under subparagraphs 10 and 11) and the corporations that manage and operate any of such funds;</p> <p>13. Corporations that manage any mutual aid business pursuant to a relevant Act;</p>
Source: Financial Service Commission, Republic of Korea, 4/11/2011 (Act) and 4/8/2011 (Decree), www.fsc.go.kr/eng/lr/list03.jsp?menu=0203&bbsid=BBS0087	

Appendix 1.2 Regulation on Issuance, Public Disclosure, Etc. of Securities

<p>Article 2-1 (Persons Excluded from Number Invited to Subscribe)</p>	<p>(1) "Persons specified and publicly notified by the FSC" in Article 11 (1) 1 (b) of the Decree refers to those falling under any of the following subparagraphs:</p> <ol style="list-style-type: none"> 1. The Public Capital Redemption Fund under the Public Capital Redemption Fund Act; 2. The National Pension Fund under the National Pension Act; 3. The Veterans' Pension Fund under the Veterans' Pension Act; 4. The Non-Performing Asset Management Fund under the Act on the Efficient Disposal of Non-Performing Assets, etc. of Financial Institutions and the Establishment of Korea Asset Management Corporation; 5. The Deposit Insurance Fund under the Depositor Protection Act; 6. The Exchange Equalization Fund under the Foreign Exchange Transactions Act; 7. The National Housing Fund under the Housing Act; 8. A person specified in Article 56-2 of the Enforcement Rule of the Corporate Tax Act (excluding those under Article 10 (2) 16 or 17 or Article 10 (3) 10 or 11 of the Decree in such cases); <Amended Jul. 6, 2009> <p>(2) "Persons specified and publicly notified by the FSC" in Article 11 (1) 1 (f) of the Decree refers to those under any of the following subparagraphs:</p> <ol style="list-style-type: none"> 1. A company specializing in investment in start-up of small and medium enterprises under the Support for Small and Medium Enterprise Establishment Act; 2. A person similar to a company under subparagraph 1 or an expert under 3. any item of Article 11 (1) 1 of the Decree, who is specified by the Governor of the Financial Supervisory Service (hereinafter referred to as the "FSS Governor") as an expert with special knowledge of financial status or business prospects of an issuer. <p>(3) "Persons specified and publicly notified by the FSC" in Article 11 (1) 2 (g) of the Decree refer to those falling under any of the following subparagraphs:</p> <ol style="list-style-type: none"> 1. A company that uses products of an issuer (excluding a company in the process of incorporation) directly as raw materials or that supplies its products to an issuer (excluding a company in the process of incorporation), or an executive of such company; 2. A person engaging exclusively in distribution of products of an issuer (excluding a company still in the process of incorporation) under a distributorship contract with the issuer, or an executive of such person; 3. A member of an organization, such as an association, etc., if an issuer is a company (including a company still in the process of incorporation) in which members of the organization have jointly invested to engage in business activities for public purposes or public interest, such as the press, academic activities, and research; 4. A member of a specified local organization, such as a local chamber of commerce and industry, a local merchants' association, and a local farmers' or fishers' organization, if an issuer is a company (including a company still in the process of incorporation) in which members of such organization have jointly invested to engage in joint business activities, such as disposing of industrial waste, providing financial or insurance services, or manufacturing, processing or distribution of agricultural, fishery, or livestock products in the locality; 5. A member of an organization, such as an alumni association or clan association, if an issuer is a company (including a company still in the process of incorporation) in which members of such organization have jointly invested in accordance with a consensus to have the company engage in joint business activities; 6. A stockholder of a corporation that is not obligated to submit business reports pursuant to Article 159 (1) of the Act (hereafter referred to as "corporation exempted from submission of business reports" in this Article), if the stockholder receives securities issued by another corporation exempted from submission of business reports in consideration for a merger with the former corporation exempted from submission of business reports, all-inclusive exchange or transfer of stocks, division or divided merger;
----------------------------------------------------------------------------	----------------------------------------------------------------------------------------------------------------------------------------------------------------------------------------------------------------------------------------------------------------------------------------------------------------------------------------------------------------------------------------------------------------------------------------------------------------------------------------------------------------------------------------------------------------------------------------------------------------------------------------------------------------------------------------------------------------------------------------------------------------------------------------------------------------------------------------------------------------------------------------------------------------------------------------------------------------------------------------------------------------------------------------------------------------------------------------------------------------------------------------------------------------------------------------------------------------------------------------------------------------------------------------------------------------------------------------------------------------------------------------------------------------------------------------------------------------------------------------------------------------------------------------------------------------------------------------------------------------------------------------------------------------------------------------------------------------------------------------------------------------------------------------------------------------------------------------------------------------------------------------------------------------------------------------------------------------------------------------------------------------------------------------------------------------------------------------------------------------------------------------------------------------------------------------------------------------------------------------------------------------------------------------------------------------------------------------------------------------------------------------------------------------------------------------------------------------------------------------------------------------------------------------------------------------------------------------------------------------------------------------------------------------------------------------------------------------------------------------------------------------------------------------------------------------------------------------------------------------------------------------------------------------------------------------------------------------------------------------------------------------------------------------------------------------------------------------------------------------------------------------------------------------------------------------------------------------------------------------------------------------------------------------------------------------------------------------------------------------------------------------------------------------------------------------------------------------------------------------------------------------------------------------------------------------------------------------------------------------------------------------------------------------------------------------------------------------------------------------------------------------------------------------------------------------------------------------------------------------------------------------------------------------------------------------------------------------------------------------------------------------------------------------------------------------------------------------------------------------------------------------------------------------------------------------------------------------------------------------------------------------------------------------------------------------------------------------------------------------------------------------------------------------------------------------------------

continued on next page

Appendix 1.2 continuation

	<p>7. Any other person similar to a related person under subparagraphs 1 through 6 above or any item of Article 11 (1) 2 of the Decree, who is specified by the FSS Governor as a specially-related person with special knowledge of financial status or business prospects of an issuer.</p>
<p>Article 2-2 (Criteria for Resale Deemed Public Offering of Securities)</p>	<p>(1) "Cases where it falls under the criteria prescribed and publicly notified by the FSC for resale" in Article 11 (2) of the Decree mean any of the following cases:</p> <ol style="list-style-type: none"> 1. For equity securities (including depository receipts related to equity securities; the same shall apply hereafter in this Article and Article 2-3 (2), where securities of the same kind have a past record of public offering or public sale or are listed on the securities market. In such cases, securities issued by a company incorporated as a consequence of division or divided merger (excluding physical division under Article 530-12 of the Commercial Act) shall be deemed securities of the same kind as those issued by the divided company; 2. For securities other than equity securities, where the number of securities 3. issued is 50 or more or the number of securities split after issued is 50 4. or more and such securities are transferable; 5. Where securities that are subject to a right conferred in securities, such 6. As a right of conversion and a preemptive right to new stocks, fall [sic] under subparagraph 1 or 2. 7. <Deleted Jul. 6, 2009> <p>(2) Notwithstanding paragraph (1), it shall be deemed that none of the following cases falls under the criteria for resale under paragraph (1) in issuing securities:</p> <ol style="list-style-type: none"> 1. Where securities are deposited (including registration under the Registration of Bonds and Debentures Act; the same shall apply hereafter in this Chapter) in the Korea Depository (hereinafter referred to as the "Depository") immediately after the issuance of the securities and a deposit contract is made with the Depositor to agree that such securities (including securities acquired by exercise of rights conferred in the securities) shall not be withdrawn nor sold for one year from the date of deposit and such deposit contract is duly performed, or where measures necessary to prevent equity securities, acquired by the Government or the Korea Deposit Insurance Corporation as a result of investing in an insolvent financial institution pursuant to Article 12 (1) of the Act on the Structural Improvement of the Financial Industry (hereinafter referred to as the "Financial Industry Act"), from being resold to 50 or more persons within one year from the date of acquisition; 2. Where a special stipulation to prohibit splitting within one year is stated 3. on the face of securities, if securities under paragraph (1) 2 is less than 4. 50 units; 5. Where the period during which exercise of a right is prohibited is not less than one year after issuance in cases of paragraph (1) 3; 6. <Deleted Jul. 6, 2009> <p>(3) The Depository may, if any of the following events occurs with respect to securities deposited pursuant to the main sentence of paragraph (2) 1, permit withdrawal of such securities upon the request of the issuer. In such cases, the Depository shall require deposit of such securities again or deposit of securities acquired by exercising a right, such as a right of conversion, immediately upon the event ends;</p> <ol style="list-style-type: none"> 1. Where withdrawal is needed to exchange securities with those in a standardized size; 2. Where withdrawal is needed to exercise a right conferred in securities, such as a right of conversion and a preemptive right to new stocks; 3. Where withdrawal is needed to exchange securities with other securities for a merger, division, divided merger of companies or all-inclusive exchange or transfer of stocks; 4. Where withdrawal is needed to exchange securities with new ones for stock split or consolidation of shares, a change in the par or stated value; 5. Where the FSS Governor approves that withdrawal is needed for any other event similar to those set forth above.
<p>Article 2-2-2 (Criteria for Resale Deemed Public Offering in Issuing Overseas Securities)</p>	<p>(1) Notwithstanding 2-2, where securities are issued overseas (referring to cases where essential activities related to the issuance, such as invitation to subscription, subscription, etc., are made overseas), and such securities, rights conferred therein, or securities issued by exercising such rights (hereafter referred to as "relevant securities, etc." in this Article) are issued under the condition that any resident under the Foreign Exchange Transaction Act (excluding financial investment business entity that acquires the relevant securities in accordance with the underwriting contract related to the issuance of the securities; hereafter in this Article, the same shall apply) is eligible to acquire the relevant securities at the time of the issuance or within one year from the issuance date, such cases shall be deemed "cases where it falls under the criteria prescribed and publicly notified by the FSC for resale" in Article 11 (2) of the Decree.</p>

continued on next page

Appendix 1.2 continuation

- (2) Notwithstanding paragraph (1), any of the following cases shall be deemed not falling under the criteria for resale under paragraph (1):
1. Where a condition that relevant securities, etc. shall not be transferred to any resident at the time of issuance or within one year from the issuance date is stated on the face of such securities (limited to cases where any physical instrument is issued), the underwriting contract, acquisition contract, or a written invitation to subscription; the issuer or underwriting financial investment business entity requires an acquirer to furnish a written consent with a signature confirming the condition attached to the issuance; and such securities are issued after making a devise for securing the performance of the written consent;
 2. Where securities are deposited in an officially recognized depository in the issued place immediately after issued; a depository contract is made with a condition that the relevant securities, etc. shall not be withdrawn or transferred to any resident within one year from the date of deposit; and then such deposit contract is performed;
 3. Where a professional investor under Article 11 (1) 1 (a) or (b) of the Decree (hereafter referred to as "professional investor" in this subparagraph) acquires (including acquisition from the issuer or underwriter at the time of issuance) corporate bonds, which shall not be convertible bonds, bonds with warrant, or exchangeable bonds, and such securities are transferred only between professional investors and all the following requirements shall be satisfied:
 - (a) Securities shall be issued in foreign currency and the principal and interest shall be paid in foreign currency;
 - (b) At least 80/100 of the amount issued shall be allocated to non-residents (limited to securities acquired from the issuer or underwriter at the time of issuance);
 - (c) Corporate bonds shall be those listed on a major overseas market specified by the FSS Governor (hereafter referred to as "major overseas market" in this item), those registered with or reported to a foreign financial investment supervisory agency of the country in which a major overseas market is established, or those for which any other procedure that may be deemed public offering is completed;
 - (d) Measures shall be taken to state the condition that bonds shall not be transferred to any resident other than professional investors at the time of issuance or within one year from the issuance date on the face of such bonds (limited to cases where any physical instrument is issued), the underwriting contract, acquisition contract, or written invitation to subscription;
 - (e) The issuer and managing company (limited to cases where a managing company is appointed; the same shall apply hereafter in this item) take the measures under items (a) through (d) and the issuer and managing company shall severally or jointly preserve relevant evidential documents;
 4. Where relevant securities, etc. are issued otherwise with a structure under which any resident is unable to acquire such securities at the time of issuance or within one year from the issuance date.

Source: Financial Supervisory Service, www.fss.or.kr

References

- Deutsche Bank AG Domestic Custody Services, Market Guide
- State Street
- HSBC explanation materials for ADB Team
- 2010 – THE GUIDE TO CUSTODY IN WORLD MARKETS by State Street
- asianbondsonline.adb.org

Korea Capital Market Institute(KCMI)
Secretariat of ASEAN+3 Bond Market Forum-Korea KOFIA Building,
143 Uisadang-daero, Yeongdeungpo-gu Seoul 150-974 Korea

Prof. Shigehito Inukai
Faculty of Law, Waseda University
1-6-1, Nishiwaseda, Shinjuku-ku, Tokyo, 169-8050
Tel & Fax (Direct): + 81-(0)3-3202-2472
Mobile: +81-(0)80-3360-7551
E-Mail: shige.inukai@me.com

Lao PDR Bond Market Guide

Contents

Acknowledgement	v
I. Overview and Instruments	1
A. Overview	1
B. Debt Instruments	10
C. Lao People’s Democratic Republic Stock Exchange—History, Mission, and Vision.....	10
II. Participants	12
III. Legal and Regulatory Framework.....	13
A. Regulatory and Supervisory Framework.....	13
B. Laws and Decrees on the Financial Sector.....	15
C. Laws and Regulations on Financial Transactions	15
D. Legal Framework of Securities Issuance	17
E. Legal Framework of Investor Protection	18
IV. Foreign-Investment Related Laws and Exchange Control.....	19
A. Foreign Investment Law (1994).....	19
B. Cross-Border Portfolio Investment.....	19
C. Currency Exchange Controls.....	19
D. Taxation	20
V. Market Regulation and Infrastructure.....	21
A. Bond Operation in Lao PDR	21
B. Inter-bank Market	21
C. Auction Process	22
D. Settlement and Clearing.....	23
E. Taxation and Tax Exemption.....	23
VI. Budget, Debt, and Cash Management of the Ministry of Finance	24
A. Relevant Departments of the Ministry of Finance	24
B. Budget Management and Government Securities	24
C. Debt Management	25

VII. Review of Fixed-Income Securities	27
A. Historical Background	27
B. Treasury Bills	27
C. Recapitalisation Bonds.....	29
VIII. Immediate Action, Roadmap, and Work Programs	30
A. Action 1: Strengthening Capacity of the Ministry of Finance	30
B. Action 2: Developing the Legal and Regulatory Framework for Corporate Bonds	31
C. Action 3: Developing the Inter-bank Market.....	32
D. Action 4: Developing Institutional Investors	33
E. Immediate Action 5: Developing the Securities Business	34
F. Roadmap	34
G. Work Programs for 2011–2012.....	35
IX. Market Statistics	36
Appendixes	38
Appendix 1: Decree on Securities and Securities Market.....	38
Appendix 2: Part II. Disclosure by Bond-Listed Corporation	51
Appendix 3: Law on the Promotion and Management of Foreign Investment in the Lao People’s Democratic Republic	52
Appendix 4: Law on the Promotion of Foreign Investment No. 11/NA (2004)	55
Appendix 5: Presidential Decree Law No. 01/P, 17 March 2008 on Governing the Management of Foreign Exchange and Precious Metals.....	61

Boxes, Figures, and Tables

Boxes

Box 1.1	Extract from the National Socio-Economic Development Plan (2006–2010).....	2
Box A1.1	Decree on Securities and Securities Market	38
Box A1.2	Part II. Disclosure by Bond-Listed Corporation	51
Box A1.3	Law on the Promotion and Management of Foreign Investment in the Lao People’s Democratic Republic	52
Box A1.4	Law on the Promotion of Foreign Investment No. 11/NA (2004).....	55
Box A1.5	Presidential Decree Law No. 01/P, 17 March 2008 on Governing the Management of Foreign Exchange and Precious Metals	61

Figures

Figure 5.1	The Auction Process	22
Figure 7.1	Process of Coupon Redemption of Treasury Bills Issued to Commercial Banks	29

Tables

Table 3.1	Laws and Decrees on the Financial Sector	15
Table 3.2	Laws and Decrees on Financial Transactions	15
Table 3.3	Details of Lao Securities Exchange Regulations	16
Table 6.1	Approved Budget and Deficit Financing, FY2010–2011 (KN billion)	25
Table 8.1	Roadmap of Bond Market Development in Lao PDR (2011–2020)	34
Table 8.2	Work Programs for Jumpstarting the Bond Market in Lao PDR (2011–2012)	35

Acknowledgement

The Asian Development Bank (ADB) Team, comprising Satoru Yamadera (Economist, ADB Office of Regional Economic Integration, - September 2011), Seung Jae Lee (Principal Financial Sector Specialist), Shinji Kawai (Senior Financial Sector Specialist [Banking]), Shigehito Inukai (ADB consultant), Taiji Inui (ADB consultant), and Matthias Schmidt (ADB consultant), would like to express our sincere gratitude to the following National Members and Expert Institutions: the Ministry of Finance of Lao People's Democratic Republic (PDR), the Securities and Exchange Commission Office, and the Bank of the Lao PDR. They kindly provided us the Market Guide source information.

It should be noted that any part of this report does not represent the official views and opinions of any institution which participated in this activity as ASEAN+3 Bond Market Forum members and experts.

The ADB team bears responsibility for the contents of this report.

February 2012

Asian Development Bank (ADB) Team

I. Overview and Instruments

A. Overview

The Lao People's Democratic Republic (Lao PDR) domestic bond market is still in its early stages.

1. Development of the Market-Oriented System and Financial Sector Reforms

Since the introduction of the New Economic Mechanism in 1986, Lao PDR has been gradually moving from a centrally-planned economy toward a market-oriented system. It has planned a wide range of reforms, with the assistance of various supranational bodies such as the World Bank, Asian Development Bank (ADB), International Monetary Fund (IMF), and the European Union.

Financial sector reforms are one of the country's priority initiatives, with banking sector reforms the government's current focus. These reforms involve strengthening the operation and oversight functions of the Bank of the Lao PDR (BOL), and restructuring state commercial banks by improving their lending decisions and risk management systems. A number of legislative reforms to support financial sector development have been passed, including the *Decree Law on Foreign Currency* and *Decree Law on Commercial Banks*.

2. The National Socio-Economic Development Plan (2006–2010)

The sixth Five-Year National Socio-Economic Development Plan covered the period 2006–2010. It outlined the plans and strategies to achieve the targets set in the Ten-Year Socio-Economic Development Strategy. The sixth five-year plan focused on the following areas:

- Promoting economic development;
- Increasing competitiveness and utilizing comparative advantages; and
- Strengthening the positive linkages between economic growth and social development.

3. National Socio-Economic Development Plan (2006–2010)

Box 1.1 Extract from the National Socio-Economic Development Plan (2006–2010)

PART I: IMPLEMENTATION OF THE FIFTH NATIONAL SOCIO ECONOMIC DEVELOPMENT PLAN (2001–2005) (EXTRACT)

III. CONSTRAINTS AND LIMITATIONS

B. Monetary and Fiscal Management

3. Financial Sector

The administration of financial sector policies has been slow in solving several issues. The monetary policy framework is limited and incomplete. It is mainly based on the obligation and issuance of bonds of the Bank of Lao PDR while credit and marketing officers may not yet use them. It is for such reasons that the sources of money and credit are restricted. The exchange rate management mechanism is not yet fully consistent with the actual conditions, thereby limiting the efficiency of its implementation. The use of foreign currencies in transactions by enterprises and the general population is still widespread.

The central bank has not yet been able to set indicative interest rates to guide the market. The administration and the setting of guidelines for market rates still encounter severe difficulties.

During the last two years of the Fifth Plan, interest rates on loans extended to economic entities remained substantially high although the rate of inflation declined significantly, thereby adversely affecting economic growth.

The financial market is developing within a limited scope. Credit is limited and meets only 15 percent of the requirements. The loan amortization periods are short and there is pressure on the operations of enterprises and the capacity of the commercial banks to recover loans. The volume of repayments overdue in the banking system is substantial and is concentrated mainly in the domestic commercial banks, which suffer from poor financial capacity and quality of transactions. High non-performing loans (NPL) are a drag on credit flow and high interest rates remain.

D. External Economic Relations

2. Foreign Investment

Foreign investment increased at a slow pace. Investments in the agriculture, forestry and fisheries sectors and areas with difficult access are very limited. At the same time, the capacity to attract investments in the industrial sector remains low. The licensing process is time consuming and cumbersome. Foreign investors face many difficulties due to the insufficiently open investment environment, inadequate facilities, and the lack of consistency and predictability. The costs of inputs such as fuel, electricity, telecommunications and shipping are much higher than in many other countries in the region, restricting the competitiveness of Lao products and services and the attractiveness of the Lao PDR to foreign investors. Also, there are very few investors with the capacity to raise large volumes of funds from the regional and international economic groups.

One of the main causes restricting the growth of foreign investment in the Lao PDR is the insufficiency of skilled labour. Currently, skilled labour represents only 2 percent of the total labour force and is not able to meet the requirements of foreign enterprises which need highly skilled labour.

F. Limitations and Causes

1. Limitations

Nevertheless, the economy of Lao PDR needs to overcome the following limitations:

The economic growth rate remains below the Plan target and has not met its full potential, while ODA is stable and remains significant, covering a major proportion of the national budget's development investments specifically and more generally of the total investments.

FDI sources have increased and cover a higher share of the total investment. Funding from enterprises, the domestic private sector and bank credit for investment remain low and are characterized by inward-looking self-sufficiency. Capacities in production, and the quality and efficiency as well as competitiveness are still low. The main types of markets are newly set up and less developed, especially the capital market;

There is a severe shortfall in revenues, expenditures are excessively high and the budgetary targets are not firmly maintained. Public debt—including domestic and foreign debt—incurred by the Government is overwhelming and the debts of enterprises are also substantial; and Many social issues are problematic, including the delay in the payment of salaries and very low salary packages for Government officials and people whose main income is from the Government budget. This fact is likely to result in the low quality of services provided by Government officials.

Box 1.1 continuation

VI. MACRO DIRECTIONS

C. Financial Sector

1. Banking Sector

One of the important objectives in the financial sector is to continue to refine the legal framework for the banking sector to better meet the needs of the fast developing economy including its increasing international integration. Laws on Banking and credit organizations would be modified and supplemented to serve as the basis for the development of the capital markets. The financial capability of commercial banks would continue to be strengthened, with a move towards the full implementation of internationally accepted rules and standards on banking activities.

The operations of the commercial banks will be guided toward the provision of improved credit services to the economy based on the principles of safety, efficiency and self-sustainability.

Priority would be given to supporting the production, processing and marketing of key products/goods in the agriculture sector and in rural areas. The commercial banks will be encouraged to expand the provision of credit to profitable and effective projects.

The dynamism of the commercial banks will be improved by reducing the interventions by relevant authorities in their operations. Improvements will be achieved in the procedures and practices of commercial banks for the provision of loans. Monitoring and adjusting mechanisms in providing loans by commercial banks will be based on asset ownership (collateral). They will be encouraged to diversify monetary and banking services. The development of capital markets and foreign exchange trading among commercial banks will enhance the capacity of the state-owned commercial banks (SOCBs) including in lending.

The staff skills will be improved to support the activities of commercial banks and ensure strict monitoring and evaluation of the commercial bank system.

The Government will monitor SOCBs and enforce adherence to government agreements. There will be an examination of the accounting system to bring it up to international standards. There will be some changes in the classification of debts of the SOCBs based on international standards. Regulations will be enforced widely and these include shark loans, exchanges, guarantees and other conditions in order to allow creditors to collect their debts, including through confiscation and sale of the debtors' properties. There will be improved assessment of the creditworthiness of borrowers and increased monitoring of the loans by the banks to reduce loan losses. Transparency will be taken seriously in evaluating debt amounts accurately.

The Government is committed to recapitalise the state-owned commercial banks (SOCBs) through the provision of about 700 billion Kip [sic] in 2006 and 2007. The restructuring and strengthening of the SOCBs will continue, especially the three major ones (Banque Pour Le Commerce Extérieur Lao, the Lao Development Bank and the Agriculture Promotion Bank) building upon the results of the diagnostic financial audits of the institutions. The Government is also exploring the feasibility of partial privatization/joint ownership of the Lao Development Bank.

The Agriculture Promotion Bank (APB) will be transformed into a self-sustaining, market-oriented rural financial institution. A variety of micro-finance institutions will be encouraged.

The Policy Statement, the Industry Assessment and Action Plan developed by the Rural Microfinance Committee were endorsed in early 2004 by the Prime Minister's Office. The Policy and action plan aim to promote a sustainable development of microfinance industry by encouraging microfinance institutions to have diverse forms and ownership and discourage subsidized credits.

The judicial foundations and regulations to support the implementation of lending by SOCBs will be strengthened based on common policies, in order to eliminate free loans and investments that do not comply with commercial practices.

The BOL will continue improving and creating regulations related to, among others, the monitoring of the operations of the commercial banks and their loans based on their capital, assets, management, earnings and liquidity (CAMELS) ratios. There will be a study on the feasibility of initially putting in place an advance warning system, based on the Basel Principles, especially on forecasting the interest and profit trends, prices of services and the growth of loans. Monitoring of the SOCBs will utilize modern technology.

It is planned to assess BOL's capacity to pay interest on the mandatory reserves of commercial banks (and other financial intermediaries) deposited with BOL. The assessment is to be based on the revenue resources of BOL, derived through the management of foreign currency funds, and the effectiveness of the tools in the open-market operations and repayment operations.

The Government plans to gradually eliminate preferences for State-owned banks. At the same time, State-owned [sic] banks would be required to stop their direct involvement in the business activities of commercial banks. The banking services such as savings and loans will be developed further and the operations will be modernized adopting the e-transaction systems.

Investments in inter-bank settlement, credit payment mechanisms and the deployment of a number of new services will be increased. The financial services will be diversified and their quality and quantity improved, thereby increasing their contribution to the value added in the services sector. The

continued on next page

Box 1.1 continuation

communications modalities in the financial and banking systems will be modernised to make the services courteous and expeditious. The Government plans to develop and increase the quality of the people's credit system.

Regulations on peoples' credit funds (including Village Development Funds) will be announced to suit the special needs of the social economy and the population. Loans will continue to be provided for people to help build independent associations on the basis of volunteerism, self-reliance and self-motivation.

4. Legal Framework

The drafting and finalizing of the legal framework that better fits the socialist-oriented economy of the Lao PDR and is in line with the commitments on integration and opening markets will be completed. This will help establish a base for business development in all economic sectors. It will ensure the systematic implementation of fair, consistent and stable financial sector policies across all economic sectors and groups.

5. Financial Market Development

There will be a comprehensive plan to expand the financial market in the initial years of the Sixth Plan (2006–2010) in accordance with the directions of safety, tight management monitoring and benefit protection for all target groups, who invest in the Lao financial market. There will be a focus on developing a financial capital market first by referring to the contribution of resources into business activities including monetary, foreign exchange, property and other unique ways of conversion of resources into capital.

The financial markets will be expanded with transparency in short-term capital swapping and trading of currencies. Relationships between monetary and financial markets, policies, accounting management mechanisms and progress monitoring will be strengthened. The development of a market for State bonds is still at an initial stage. Research will be undertaken for improving market strengths through assessing the real returns (benefits). This will help reflect any turbulent changes in the market value of the State bonds. Several tasks will be implemented at the beginning of the Sixth Plan, such as conducting tenders for selling State bonds through Lao banks and targeted purchasers, obtaining approval of the National Assembly for a clear domestic borrowing (state bond selling) plan with the annual budgets, showing ownership, dividing the bonds into sub-groups, and informing commercial banks to maintain funds to purchase State bonds at the beginning of the year.

Research will help in the experiment of establishing a stock market in Vientiane Capital City [sic] by the end of the final year of the Sixth Plan.

D. Fiscal Management

1. Fiscal Management

The overall objective is to implement a policy on sound State Budget striving for higher revenues and prudent expenditures. The fiscal policy will aim at increasing revenue mobilization to reach about 17–18 percent of GDP by 2010. Expenditure will be allocated more appropriately, carrying out measures to revitalize finance-budget activities, and to cut down the budget deficit to a safe ratio. Budget revenue collection performance will be increased with concerted efforts to improve customs and tax administration. Stronger monitoring mechanisms will be developed to monitor revenue collection and central-local coordination on revenue collection will be improved.

The measures to achieve the targets are to first establish a legal framework governing the state budget and finance including the following:

- (i) the amendment of the State Budget Law to enhance the powers and responsibilities of central and local authorities in budget management, with the clear decentralization of financial administration to ensure the decisive role of the central budget, and at the same time promote self-control at the local level;
- (ii) implement the revised Tax law and tax policies to ensure State budget revenues; carry out studies to modify tax-exemption policies to fit the current national context; and establish the necessary legal framework to ensure the collection of state budget revenues and create a development environment for the financial and capital markets; and
- (iii) widely disseminate (popularize) the relevant laws/regulations and coordinate closely with all relevant authorities to implement them. The budget administration should be considered a responsibility of the entire Government and the people.

Second, to firmly implement measures in budget management including the following:

- (i) on the revenue side, enhance revenue regulation, implement immediately measures to avoid revenue losses (in terms of both the number of tax-payers and amount of revenue), and definitely abolish arbitrary tax exemptions that do not comply with the law; and definitely terminate the provision of loans from the State budget or the Government underwriting of loans to state-owned enterprises (SOEs);
- (ii) on the expenditure side, line ministries and authorities would have to follow the spending plans in the budget approved by the National Assembly, with no entity or individual exercising the right to decrease budget revenue or increase expenses without jurisdiction; and in case there are ad-hoc expenses [sic], these would be covered by reallocation of spending to ensure budget balance;
- (iii) on investment capital, continue to implement the approved or to-be-approved foreign-assisted projects; with the selection and signing of only the priority FDI projects, and allocate sufficient counterpart funds for such projects; and repay (capital construction) debts; and
- (iv) on regular (recurrent) spending, review expenditure items and establish spending criteria that match the national context and the budget, which will serve as a basis for cutting down subsidized expenses.

Box 1.1 continuation

Improve the salaries of civil servants, and prioritise education, training and social activities.
Adapt specific measures for savings in expenditures, especially in administrative expenses.

Third, it is agreed that the Ministry of Finance will take the lead role in managing foreign debts. Localities (Provinces, Municipalities and Districts) are not permitted to borrow from foreign countries. It is essential to promptly settle public debts to revitalize financial and budget activities. Adequate budget will be allocated to service foreign debts according to the commitments. Relevant authorities would be proactive in negotiating debt conversion (including write-off), extension of repayment period, reduction in interest rate, etc., especially on loans for re-lending. Also, domestic debts will be classified and proper measures will be taken to solve current debts and prevent a rise in debts.

Fourth, monitoring against the loss of State revenues, properties and expenditures will be strengthened. The enforcement of financial discipline will be further enhanced, strictly dealing with cases that break regulations on the management of budget receipts and payments, for example, tax-exemptions not according to jurisdiction, slow payments to the Treasury, and spending beyond the mandate of policies and regulations.

Fifth, the decentralization mechanism in terms of budget management between central and local authorities will be renovated and refined to improve the State management of finance.

The limited State budget resources and a lack of tight financial discipline require the reorganization of the tax and fee collecting organizations and the State budget management organizations (State Treasury) aimed at receiving the right and full amounts of taxes and fees on time. Firstly, Customs and the State Treasury in the Ministry of Finance would be organised systematically from the centre to the localities, with the centre responsible for overall management, including the number of personnel and salaries. The tax collection organizations will be made accountable for the loss of revenues from taxes. As indicated earlier, the Budget Law will be modified, decentralizing the revenue resources between the centre and the localities. Basically, branches of the central tax organization would be in charge of collecting all the tax receipts of the entire centre and those decentralized between the centre and local budgets. Tax offices of the localities in the Department of Finance will be in charge of collecting the local tax receipts. The budget will be managed effectively with adequate controls on the receipt and payment activities of organizations and localities.

The fiscal sector including Customs and Treasury will be modernized in order to improve the effective management of state budget activities. The training of financial staff will be strengthened as indicated in fiscal budget management for the entire country in the next stage.

Domestic resource mobilisation has to be increased. Bottlenecks will be removed to increase domestic investment and to develop a competitive market. The institutions needed to better enforce contracts and other property rights have to be developed. These are essential prerequisites for developing an effective financial system. Remittances from overseas Lao Nationals and workers will be encouraged.

VII. THEMATIC AND CROSS-CUTTING AREAS

F. Private Sector Development

2. Specific Strategies

Some of the main areas contributing to the enhancement of the business environment have been identified:

- a) enabling policies, regulations and practices,
- b) improvements in the legal framework,
- c) information and consultation,
- d) a more favourable macroeconomic environment, and
- e) improved coordination and management capacity.

These are discussed briefly in the following:

- a) Policies, Regulations and Practices

Policies will be drafted and issued aiming at facilitating the rapid development of the private sector, including businesses of all types and sizes. The private economic sector will be supported via an equal and fair business environment for both private and state enterprises.

The business law has to be finalised, implemented and enforced. There will be immediate action on the promulgation of the law against monopolies and barriers that confront enterprises. Private enterprises do not have to obtain any further permission certificates when there is equality in operation based on rules and decrees regarding a list of permission certificates. Procedures of application and other unnecessary restrictions will be limited to build connections among state organizations and to increase outside enterprises entering the markets (e.g., enterprise registration, procedures for obtaining official stamps, tax registration, leasing land for operating business and conditions for applying for loans).

Box 1.1 continuation

The administrative application system for business activities of enterprises within the private economic sector will be reformed. There will be a reform of the procedures such as monitoring, calculation and enterprise accounting in order to facilitate activities and increase the effectiveness of monitoring. The Government will continue the public administration reform related to business operation, improving the efficiency of monitoring and evaluation works toward creating more favourable conditions for all types of businesses. Policy makers need to respond quickly in taking concrete measures to reduce barriers to business investment.

Government administration and organizations will be disciplined to prevent the rejection of business applications. There will be an experiment to transfer the application processes to business associations and capable sectors. Regulations of the three business coordinating organizations will be announced. Regulations on such aspects as business registration, official stamp management and customs will be disseminated. Information on enterprises will be supplied to banks as a reference for granting loans. There will be an experiment on enterprise services to assist banks issuing limits on their loans. There will be campaigns on collecting funds for growing investment through selling enterprise, state and Vientiane (municipal) bonds.

The priority is to reform the regulations and administrative constraints that give rise to monopolies, such as expanding the number of tourist operators permitted to establish in a province, lifting restrictions on movements of goods between provinces and not limiting provincial contracts to local firms. Relevant Government agencies should be charged with studying and taking action to increase competition in priority areas, such as transport, logistics and freight handling. Discrimination between the state and the private sectors will be eliminated. The Government will complete the granting of land-use certificates and ensure land-use-related rights to businesses. It will review and revise the credit and banking policies with a view to expanding the target group and simplifying loan provision and allocation procedures. The overall business information system will be established and strengthened to support business operations as well as assist Government authorities in terms of monitoring and evaluation.

Small and medium enterprises (SMEs) will receive special attention and appropriate legal frameworks will be put in place at least by the end of the Sixth Plan (2010). The Prime Minister's Decree on the Promotion and Development of Small and Medium Sized Enterprises (No. 42/PM) issued on 20 April 2004, provides the overall framework for defining the directions and policies, establishment of SME support fund and support organizations, and regulations, practices and measures to promote and develop SMEs in the country. The Decree identified six priority policy areas for SME promotion and development:

- (i) creating an enabling regulatory and administrative environment;
- (ii) enhancing competitiveness;
- (iii) expanding domestic and international markets;
- (iv) improving access to finance;
- (v) encouraging and creating favorable conditions for establishment of business organizations; and
- (vi) enhancing entrepreneurial attitudes and characteristics within society.

Support to SMEs will be strengthened. Traditional handicrafts will be developed and handicraft villages will be built to create jobs, generate income and develop the nonagricultural sectors in rural areas.

b) Legal Framework Improvement

The Government will promote the drafting and finalizing of the legal framework that better fits the socialist-oriented economy of the Lao PDR. This will help establish a base for business development in all economic sectors. The country will have a comprehensive legal system, which is a factor for effectiveness in a market-oriented economy. Legal procedures will be rationalized and improved with declaration, enforcement, dissemination and serious studies. There will be research done to adjust, improve or add some details to the existing legal system, especially in the areas of commerce, bankruptcy, enterprise, labour, credit, state budget and land acquisition, to suit the objectives of implementing the socio-economic strategy and of participating in the international economy. New laws will be formulated to suit the development objectives and facilitate participation in the international arena.

The judicial system will be based on equality for facilitating foreign and domestic investments, in relation to building a stable environment and equity in business-production.

The regulations and policies on investments will be implemented to suit each objective.

Judicial documents will be improved in order to prevent documents that are against overall regulations. There will be transparency in the application procedures, and administrative mechanisms will be based on a one-stop corridor window at the central and local levels for foreign investments.

The law related to competition will be announced in order to encourage state-owned enterprises (SOEs) to receive fair competition. For monopolistic enterprises, the Government will have rules to monitor pricing and benefits.

The establishment of a central register of all legal documents and instruments related to private sector development is a high priority. A Registry of Secured Transactions has been established in the Ministry of Finance and will require technical support for making it functional.

3. Foreign-Invested Sectors

Box 1.1 continuation

A favourable environment will be created to attract foreign direct investment (FDI), especially from the main companies in Asia. It is necessary to be aware that FDI is an organic part of the economy and will be further developed in parallel with the country's socioeconomic development process. The present situation of the Lao PDR indicates that foreign investments have played a key role in developing the country's economy and they will be major factors for development in the next decades. Despite the abundance of natural resources in the country, the discovery and utilization of such resources has not been made due to the lack of funds, skilled labour and management capacity. If the country manages to explore and utilize these resources, it will strengthen commodity production.

In general, there are limitations in attracting foreign direct investment due to the lack of a domestic workforce with technical capacity. Human resources development requires an extended period of time. A solution at the initial stage may be to import international labour required to support projects receiving foreign direct investments. Clearer labour policies will be issued to promote the private sector and foreign investors to invest more capital in developing the industries. Foreigners working for enterprises investing in the country have to contribute to commodity production. Employees and technical workers are urged to prepare for meeting the needs of foreign investments. Thus, there is an urgent need to train technical workers.

The Sixth Plan (2006–2010) will translate programmes into actions and methods for economic development that incorporate foreign investments. There will be an immediate materialization of laws related to foreign investments. The 5th National Assembly already made some changes to the mechanisms, policy, plans, procedures for granting investment permits, etc. These will be monitored regularly for further improvement and to enlarge the investment environment. This will create fast investment procedures, which will become simpler. Based on occupation types and regional specialty, a development plan will be determined in order to attract foreign investment. For example, foreign investment will be attracted in hydro-electricity, mining, food processing, cattle rearing and export industries.

A list of projects that require foreign investment will be compiled within each period of the five-years [sic] in relation to the granting of foreign investment permits. A supporting committee will be assigned to inform potential investors in capable countries to attract foreign investment. Major cities should set up meetings for discussion and report on the foreign investments that suit the capacities, strengths and priorities of the local people as well as the country. Senior Government leaders should arrange meetings with local and international investors/enterprises to receive feedback, in order to improve the public investment environment. The difficulties that confront the enterprises should be addressed and solved immediately in order to encourage and facilitate production and business operations. Regular budgets will be injected into enterprise activities to enhance integration, discussion and assistance, solving difficulties that confront foreign investors.

The Government will conduct regular assessments of enterprise business operations for every economic sector (e.g. [,] private and state sectors), and has policies to reward people with great achievements with medals. Regulations and services will be improved and disseminated in order to simplify investment, and shorten the time for granting investment permits. The effectiveness of investment promotion will be improved and there will be a new method to gain awareness about investments with ownership and suitability for local conditions and types of enterprises. The policies on investment priorities will be reviewed, including the regulations on granting investment permits, especially land acquisition fees, transportation and telecommunications service charges and others, to build a more favourable investment environment in the Lao PDR. Projects with permission can be implemented immediately and new project registration will be speeded-up.

Directions on minimizing service costs will be extended in order to obtain equal returns from both domestic and international investments. Land acquisition fees and some previous exemptions will be reviewed. Procedures and administrative permits relevant to foreign investments will be improved and the time involved for granting permits will be shortened.

There will be open registration for investments and a limitation on certificates that are barriers to foreign investments.

4. Targets

- Reform the laws and regulations involved in setting up enterprises and streamline the process;
- Finalisation, implementation and enforcement of the implementing regulations for the Business Law;
- Improve the quality and professionalism of public service provision;
- Increasing transparency;
- Hold regular meetings between the central and local level Government and the private sector;
- Reform regulations and administrative constraints that give rise to monopolies such as: lift restrictions on the movement of goods between provinces; and abolish limitations on restricting provincial contracts to local firms;
- Lift some restrictions on foreign workers;
- Reform the tax system, setting up proper monitoring agencies;
- Increase foreign investment;
- Continue to develop regulations and business operation laws and improve the business licensing processes; reduce unnecessary procedures; and increase fast and convenient services to businesses and entrepreneurs;
- Promote the establishment of enterprises, cooperatives and family businesses in all areas permitted by the Government; Increase people's access to financing.

continued on next page

Box 1.1 continuation

IX. Implementation Measures

B. Key Measures

The key measures are as follows:

1. Implementation of the Market Economy:

Continue the implementation of the socialist multi-economic sectors, establish various types of markets, and create the enabling conditions for investment in the production sector by the enterprises and the people.

a) Implementation of the multi-sectoral economy development policies:

(i) State-Owned Enterprises (SOEs)

In order to improve the performance and effectiveness of SOEs, there is an urgent need for implementation of the resolutions of the Party and the Government on urgent restructuring, reform and development of the enterprises. In the five-year period, the focus will be on the following goals and key measures:

- Complete the restructuring and reform of the SOEs from the central to the local levels. Maintain some selective key SOEs that play leading roles in the basic national economy. At the first stage of the Sixth five-year Plan, there is a need for rapid assessment to take firm action on abolishment, announcement of bankruptcy or change to other forms of ownership of those SOEs that are operating at low efficiency or inefficient;
- Formulate a comprehensive legal framework for the business management of the SOEs based on the independent financial movement;
- Improve the application of modern technology in the management of SOEs. The newly established SOEs should have comprehensive conditions based on the standards set by the sector, region and the key geographical areas. The establishment of new SOEs should be in the form of integrated enterprises, share holding companies and limited companies;
- The mechanisms and regulations that enhance the competitiveness among the state-owned business units following the market mechanism and provide a level playing field for all economic players should be established. Attention will be paid to monitoring to avoid the monopoly by the state-owned businesses. Improve the role and responsibilities between the administrative management and business management in order to make the ownership of running the businesses under the control of the state and the laws. Improve the accounting, auditing and financial reporting systems. Implement the reform of business and financial enterprises to be more transparent and accountable. Improve the effectiveness and efficiency of the state management, particularly the government sectors that own the SOEs. The state ownership and the business management rights of the government sectors, and the rights to run the businesses by the SOEs should be clearly defined. The direct intervention of the state administration in the business activities of the enterprises should be eliminated. Increase the efficiency of state monitoring on behalf of the owner of the SOEs. Increase the role of legal bodies and civil society in monitoring the state administration from the central to the local levels. Develop plan for expansion and building the business partners in SOEs. Prior to the appointment of the Director of any SOE, training should be provided to the candidate to upgrade the technical knowledge.

(ii) Domestic Private Sector

Actively promote the domestic private (economic) sector based on the equal and fair business environment (level playing field) for both private and state enterprises. Enhance the creativity in running businesses under the legal framework. Promote the model family in family businesses that lead to small- and medium-scale enterprises.

Improve the mechanism and the process so that the obligations of the domestic private sector to the state, such as the payment of land tax, should be centralized, simplified, accountable and transparent. Formulate the regulation on free information sharing services by the Government and the establishment of professional associations.

Review and remove all barriers to the domestic private sector business movement to ensure the legal independence of the business movement. Improve the speed of issuing the certificate permission process through single entrance ("one-door or one-stop"). Improve the monitoring, accounting and auditing of the enterprises following the policy on creating enabling conditions for enterprises, while at the same time improving the effectiveness and efficiency of the monitoring system.

Improve the import-export conditions and the processes to create enabling conditions for small-scale businesses to have better opportunities to legally produce unlimited quantities for export. Promote the participation of some types of businesses in the exposition of goods in the country and abroad.

Create and enhance the facilitating conditions for local authorities at each level to regularly meet and exchange views with the business units for problem-solving [sic] and necessary information sharing such as the market for their products, prices and other issues.

Attention will be paid to the development of small- and medium-scale businesses; expand the enterprise forms in the traditional professional sectors, non-rural agricultural sector and the establishment of model villages with special provision for job creation. Study the possibility of providing credit to help investors and businesses of all economic players (sectors), especially the small and medium scale businesses. The Government should provide assistance for training and technology transfer, credit schemes and market information sharing.

continued on next page

National Socio-Economic Development Plan (2006–2010) continuation

Establish the system of “budding entrepreneurs” and revolving funds for the start-up of new businesses focusing on the need for increased investment in the business development services. Special attention should be paid to the development of the services in the areas of accounting, auditing, research, design, market analysis, technical consultation and technology transfer.

Establish and improve policies and mechanisms to create facilitating conditions for enterprises to be self-reliant (master) in expanding their businesses through the accumulation and mobilization of capital in the market.

(iii) Economic Areas with Foreign Investments

Create a comprehensive facilitation to attract foreign direct investments, particularly from the main multi-national [sic] corporations in Asia. Formulate comprehensive administrative regulations and allow foreign workers to work within our country, which is an important factor contributing to boost commodity productions. Meanwhile, it is necessary to encourage and promote the Lao workforce that already has capabilities to work in other projects. In parallel, it is necessary to urgently train more domestic technical workers.

Attract many forms of investment in many types of businesses. Open the investment sector to foreign investors. Promote and encourage private foreign investors and the Lao people living abroad to invest in commodity production in order to replace imports and contribute to the development and expansion of the market. In parallel, it is necessary to provide services in science and technology, protect intellectual property rights, and provide consulting services to serve the businesses and others.

Study the regulations on admission of foreign investors that have licenses to undertake (perform) their businesses in our country to be able to use documents for land utilization as collateral (a secured property) to borrow money from financial institutions, with the investors showing other assets (properties) to provide adequate guarantee to the Government.

Study the incentives that impact on cost reductions in commodity production and lower the prices of goods enabling the country to compete with others, such as the exemption of taxes or adjustments in land leasing costs. It is necessary (required) to take into account the establishment of mechanisms and policies to manage foreign investments in a simple manner and via the “one corridor” policy from central to local levels. Continue to discuss with and find out from both domestic and foreign investors the difficulties in operating their businesses, in order to seek timely measures for problem solving.

b) Creating incentives for comprehensive market development

(i) Financial Markets Development

It is necessary to start work on the development of the financial markets at the initial stage of the Sixth Five-Year Plan, in compliance with the strategic content of the Plan. This includes the development of the stock market, money market, capital market and immovable property (including land or real estate) market in a comprehensive manner, guaranteeing their regular and safe operation to ensure the growth of the markets step-by-step.

Enhance the self-reliance of the business operations of the state-owned commercial banks.

Minimize the intervention of bureaucratic hierarchy in the provision of loans by the commercial banks. Improve the mechanisms for the provision of loans and ensure that the pledging of collateral (procurement of secured properties) is in accordance with the direction of enhancing the self-reliance.

Establish strong regulations to control monetary-financial markets in order to facilitate foreign exchange operations and the transfer (trading) of money in the market to be simple and transparent, while monitoring the movement of the volume of currencies in the market to be consistent with sound monetary management.

Strongly study the development of the bond market, setting forth the interest rate to be consistent with the changing situation and the trading within the bond market. Terminate the sale of government bonds to commercial banks to solve the problems of triangle debts (of SOEs). The sale of government bonds should be through open bidding through the banks, with the bond buyers providing clear certificates on their financial status. The Government should have an active role in selling bonds and have detailed plans on expenses by period (year) and should publicly declare the plans to enable the commercial banks to balance their capital sources and buy the bonds.

Consider developing the state-owned banks in order to enable the Government to supervise and monitor the performances of the monetary-financial system to be more transparent in solving doubtful debts through auditing of the accounts and the categorization of debts in accordance with international standards.

Study and experiment to establish the property market and stock market in Vientiane Capital [sic] towards the end of the Sixth Five-Year Plan period.

Source: Government of Lao People's Democratic Republic

B. Debt Instruments

1. Government Debt Instruments

In 1994, a directive was passed approving the issuance of Treasury-bills to help finance the budget deficit. The Government issues Treasury-bills on a regular basis to finance the country's budget deficit. The Government also issues arrears clearance bonds to clear government debt from state-owned enterprises (SOEs). A core goal of the Lao PDR's bond market development is to establish primary and secondary markets for government securities.

2. Bank Bills

The Bank of the Lao PDR (BOL) began issuing Treasury-bills in 1992 in an effort to manage the exchange rate and address excess liquidity.

3. Corporate Bonds

The Government is drafting amendments to the *Enterprise Law*, which was passed in 2006, that will support future corporate bond market development.

C. Lao People's Democratic Republic Stock Exchange—History, Mission, and Vision

1. History

The Lao PDR formally established its stock exchange, the Lao PDR Stock Exchange (LSX), in January 2011. In addition, the equities market was opened in July 2011. The Sixth Session of the National Assembly has adopted the five-year national socioeconomic plan from 2006 to 2010 that includes the establishment of the LSX at the end of 2010. The government authorized the Bank of the Lao PDR to implement such plan by appointing the General Leading Committee on LSX's establishment, consisting of His Excellency Somsavat Lengsavad, Standing Deputy Prime Minister and chairman of the General Leading Committee; Phouphet Khamphounvong, Governor of the BOL and vice chairman of the committee; and other deputy ministers as members of the committee.

On 19 September 2007, a Memorandum of Understanding (MOU) was signed between BOL and the Korea Exchange (KRX) in Seoul, Republic of Korea. H.E. Somsavat Lengsavad appointed the Securities Market Establishment Committee (SMEC) on 22 January 2008 to implement the project under the advice of Mr. Phouphet Khamphounvong. A Joint Venture Agreement between the BOL and KRX, which was in effect up to the end of July 2009, stipulated the 51% and 49% share of BOL and KRX, respectively.

The LSX was officially opened on 10 October 2010, which was presided over by H.E. Somsavat Lengsavad as the Standing Deputy Prime Minister and Chairman of the SEC, together with the governor of the BOL; the delegation from KRX; Mr. Dethphouvang Moularat, chairman and chief executive officer of the LSX; members of the diplomatic corps; representatives from the People's Republic of China; executive officers of the Vietnam Stock Exchange; representatives from the Securities Exchange of Thailand; and other related sectors. The LSX is the first capital market in the Lao PDR, which will attract huge capital to develop the nation and raise the long-term

funds for companies, and also promote the integrity of Lao financial market. Thus, Lao Government deems it necessary to establish the capital market to mobilize the long-term funds required for developing and expanding manufacturing and services sustainably.

2. Long-Term Strategy of the Lao PDR Stock Exchange

The LSX is envisioned to move toward becoming a stock exchange adhering to international standards. Its mission is to provide up-to-date and modern services characterized by transparent practices.

Opening the LSX is seen to propel economic development and offers new opportunities to individual, institutional, and/or foreign investors. Thus, the establishment of the securities exchange enables Lao PDR to become the economic center of Indochina.

The Aim of Comprehensive Services in 2020:

- Cultivate employees to be moral, and to be experts in their technical skills and knowledge to provide appropriate services to investors.
- Give knowledge on investment to investors and potential listing companies to raise funds through the stock market by on-site training and through the media.
- Testing the information technology system for guaranteeing its quality to be ready for short-term and long-term securities trading services.

It is intended to list (corporate) bonds at a later stage.

II. Participants

As the Lao PDR takes steps to establish its capital market, several key participants are involved in the effort:

- The BOL has the authority to issue bills and bonds to manage the exchange rate and liquidity in the economy. BOL is also responsible for licensing and overseeing financial institutions.
- The Department of Domestic and Foreign Investment (DDFI) is a one-stop service that oversees investment licensing and manages investment promotion.
- Social security organizations such as pension funds, insurance companies, and other non-bank financial institutions (NBFI) have recently started to invest in bonds. Insurance companies and social security organizations will likely be major investors in the LSX. For instance, the Social Security Organization (SSO) of Lao PDR oversees employees' social security funds and began investing in Treasury bills (T-bills) in 2006.
- Other key participants in the financial sector include state commercial banks, private banks, foreign bank representative offices, and the National Treasury under the Ministry of Finance (MOF).

III. Legal and Regulatory Framework

Lao PDR's capital markets are still in the early stages of development. Rules and regulations concerning the financial market are mainly supervised by the BOL and MOF. Details on regulatory agencies are discussed in this section.

A. Regulatory and Supervisory Framework

The BOL is the country's central bank and is responsible for licensing and supervising banks. The MOF, on the other hand, serves as the tax authority and has the authority to prepare the government budget including the issuance of government securities. The DDFI, formerly the Foreign Investment Management Committee (FIMC), administers the foreign investment system.

Lao PDR formally launched its stock exchange, LSX, in January 2011. The LSX opened with the listing of two companies—the Electricite du Laos Generation Company and the Banque Pour Le Commerce Exterieur Lao. LSX is responsible for making the listing rules.

1. Ministry of Finance

Under the *Decree on the Organization and Activities of the Ministry of Finance (No. 80/PM, 28 February 2007)*, MOF is the authority responsible for any matter relating to the financial sector as provided in Art. 2.10 and 2.11.¹ It oversees state banks, the insurance business, commercial banks, lottery business, and accounting, auditing and other financial services.

2. Bank of Lao People's Democratic Republic

BOL, as the central bank, has regulatory authority to license and control commercial banks, the banking system, money supply, and foreign currency exchange. It is responsible for issuing licenses to establish banks and other financial institutions. The

¹ Art. 2.10 states that the MOF “oversee(s) the State Banks; participate in research to resolve banking problems related to the public finance, research on currencies, credits and stocks market in order to fulfill its function on financial management regarding banking-monetary credits.” Art. 2.11 provides that the MOF “oversee(s) insurance business, commercial banks, lottery business, accounting auditing and other financial services; co-manage the sale of treasury bills/bonds and various types of social insurance.”

Law on Bank of the Lao PDR No. 05/NA approved on 14 October 1999 and the *Decree on the Organization and Activities of the Bank of Lao PDR No. 40/PM* issued on 6 April 2000 give the BOL the duties and authority “to establish and improve the state and commercial banking system for sustainable growth” and “to manage and inspect the activities of all banks and financial institutions under the authority in order to ensure the stability and expansion of the banking system and the financial institutions.” Art. 4, Part II of the *Law No. 5 on the Bank of the Lao PDR* dated 14 October 1995 defines the scope of rights and duties of BOL.

Part II Scope of Rights and Duties of the Bank of the Lao PDR

(New) Article 4: Scope of Rights of the Bank.

The Bank of the Lao PDR shall have the following rights:

1. Has the sole right to issue notes and coins with the approval of the Government and manages the currency circulation within the country;
2. Administers the macro monetary and shall be the bank of the commercial banks and financial institutions under its supervision and shall be the final lender to such commercial banks and financial institutions with the objective to implement the monetary policy;
3. Implements the policy on foreign currency control and exchange rate;
4. Issues its own bonds with the objective to carry out monetary policy, buys and sells bonds directly with other commercial banks and financial institutions;
5. Authorizes the establishment of branch of the Bank of the Lao PDR, the establishment of local commercial banks foreign commercial banks, financial institutions under its supervision based on the approval of the Government.

Both MOF and BOL have cooperated when necessary. As an example, BOL watches the economy and monetary conditions, and advises MOF regarding the level of ceiling rate for T-bills to be auctioned.

3. Department of Domestic and Foreign Investment

Operating under the Prime Minister’s Office, the DDFI administers the foreign investment system and reviews investment applications. Its primary functions include: promoting Laos as an investment destination, screening investment proposals, offering investment incentives, and facilitating foreign investment.² To support and encourage investment, the government offers incentives to investors in various forms, including reduced corporate profit taxes, reduced duties and turnover taxes on imported capital equipment and inputs to production, and investment permissions and guarantees. The main laws governing the promotion of investment are the *Law on the Promotion and Management of Foreign Investment* (1994), *Law on Domestic Investment* (1995), *Business Law* (1994), *Customs Law* (1994), and *Tax Law* (1995). The DDFI is designed to offer “one-stop” service to foreign investors by providing information and assistance during the investment process.

² Government of Lao People’s Democratic Republic (Lao PDR). 2004. *Law on the Promotion of Foreign Investment*. <http://www.invest.laopdr.org/investlaw04.pdf>

B. Laws and Decrees on the Financial Sector

Major laws and decrees related to the licensing/registration of the financial sector are listed below:

Table 3.1 Laws and Decrees on the Financial Sector

Jurisdiction	Name of Legal Document	Enacting Authority	Date Enacted and Latest Amendment
Bank of Lao PDR	Commercial Banks Law (No. 03/PSA)	National Assembly	26 December 2006
	Decree on Activities of the Commercial Banks Law (No. 275/PR)	National Assembly	25 September 2009 (Amended)
Commercial Banks	Presidential Decree Law on Commercial Banks (No. 02/PR) ^a	President	22 March 2000
Insurance Business	Insurance Law (No. 11/90/PSA) (This law is being revised and will pass through the National Assembly for consideration.)	National Assembly	29 November 1990
NBFI (Non- Bank Financial Institution)	Prime Minister Decree on Pawnshop (No. 10/PM)	Prime Minister	2 February 2002
	Prime Minister Decree on Leasing (No. 11/PM)	Prime Minister	18 February 1999
SEC	Decree on securities and securities exchange No.255/PM ^b	Prime Minister	24 May 2010

NBFI = Non-Bank Financial Institution; SEC = Securities and Exchange Commission
^a See <http://www.bol.gov.la/english/decreecom1.html>
^b See Appendix 2. A translated copy of the decree can also be found in the BOL website. http://www.bol.gov.la/english/PM%20Decree%20on%20Securities%20and%20Securities%20Exchange_EnglishTranslation.pdf
Sources: Bank of Lao PDR (BOL); Ministry of Justice; Ministry of Finance :

C. Laws and Regulations on Financial Transactions

Major laws and regulations related to the financial transactions are listed in Table 3.2 while details on the regulations of the LSX can be found in Table 3.3.

Table 3.2 Laws and Decrees on Financial Transactions

Financial Transactions	Name of Legal Document	Enacting Authority	Enacted Date and Latest Amendment
Banking	Commercial Banks Law (No. 03/PSA)	National Assembly	26 December 2006
Cheque	Prime Minister Decree on Cheque (No. 175/PM)	Prime Minister	22 October 1996
Secured Transactions	Prime Minister Decree on the Implementation of the Law on Secured Transactions (No. 171/PM)	Prime Minister	21 September 1999 Amended May 2005
	Law on Secured Transactions (No. 07/94/NA)	National Assembly	14 October 1994
Insurance	Insurance Law (No. 11/90/PSA)	National Assembly	29 November 1990
Foreign Currency Exchange	Presidential Decree Law on Governing the Management of Foreign Exchange and Precious Metals (No. 01/OP) ^a	President	9 August 2002
SEC	IPO regulation	Deputy Prime Minister	No. 008/SEC 21 July 2010
	Agreement on market securities management		No. 012/SEC 13 November 2010
	Agreement on regulation establishing and activities of a securities company		No. 009/SEC 21 July 2010

continued on next page

Table 3.2 continuation

Financial Transactions	Name of Legal Document	Enacting Authority	Enacted Date and Latest Amendment
	Agreement on managing regulation [of] foreign investors in market securities at Lao PDR	No. 012/SEC 19 May 2011	
	Agreement on opening information regulation Agreement on supervising security professionals	No. 014/SEC 19 May 2011	
	Agreement on audit and accounting regulation supervising security	No. 013/SEC 10 November 2010	
LSX	Regulation on market securities ^b		

IPO = initial public offering; LSX = Lao Securities Exchange; SEC = Securities and Exchange Commission
^a For full text, see <http://www.bol.gov.la/english/decrees01eng.pdf>
^b For list of regulations, see <http://www.lsx.com.la/rules/regulations/listPosts.do?lang=en>
Sources: Bank of Lao PDR (BOL); Ministry of Justice; Ministry of Finance

Table 3.3 Details of Lao Securities Exchange Regulations

Regulations	Purpose	Date
Membership Regulation	The purpose of this regulation is to stipulate the matters necessary for membership qualifications, admission and withdrawal, as well as obligations of members, and supervision of the members of the LSX established pursuant to the Government Decree on Securities and Securities Market.	22 April 2011
Market Operation Regulation	The purpose of this regulation is to stipulate matters necessary for the trading of securities in the securities market that the LSX has established pursuant to the Government Decree on Securities and Securities Market.	22 April 2011
Clearing and Settlement Regulation	The purpose of this regulation is to stipulate the matters necessary for clearing and settlement in the securities market that the LSX has established pursuant to the Government Decree on Securities and Securities Market.	22 April 2011
Deposit Regulation	The purpose of this regulation is to stipulate the matters necessary for depositing and transferring of securities in the LSX pursuant to the Government Decree on Securities and Securities Market.	22 April 2011
Securities Transfer Agent Regulation	The purpose of this regulation is to prescribe the contents and procedures to provide securities transfer and related services as an agent in accordance with the Decree on Securities and Securities Market.	22 April 2011
Listing Regulation	The purpose of this regulation is to stipulate the matters necessary for the listing of securities in the LSX pursuant to the Government Decree on Securities and Securities Market.	22 April 2011
Disclosure Regulation	The purpose of this regulation is to stipulate the matters necessary for reporting, disclosing and managing corporate information by corporations that has listed their stocks and corporate bonds on the LSX pursuant to the Government Decree on Securities and Securities Market. The details of this regulation can be found in Appendix 3.	22 April 2011
Surveillance Regulation	The purpose of this regulation is to stipulate the matters necessary for the surveillance, investigation into abnormal trading activities and inspection of members in the securities market and the follow-up actions according to the Government Decree on Securities and Securities Market.	22 April 2011

Note: LSX = Lao Securities Exchange
Source: Lao Securities Exchange.

The *Commercial Banks Law* allows banks to issue and trade securities, provided that the investment on securities in the securities market is not more than 15% of the regulatory capital. This is also referred to in the agreement on investment in securities of micro-financial and commercial banks (No. 160/BOL) dated 21 February 2011 under *Presidential Decree Law on Commercial Banks*, which allows banks to trade securities.

D. Legal Framework of Securities Issuance

1. Government Securities

The issuance of government securities is stipulated under the *Budget Law*. In order to issue government securities, the National Assembly shall approve the maximum volume of issues in advance as part of the budget.

2. The Bank of the Lao PDR

The BOL can “[issue] its own bonds with the objective to carry out monetary policy, buys and sells bonds directly with other commercial banks and financial institutions” as mandated by Art. 2, Part 2 of *Law No. 5* dated 14 October 1995.

3. Corporate Bonds

Decree on Securities and Securities Exchange No. 255/PM

Part I General Provisions

Article 3. Definitions of Terms

Defined terms in this Decree shall be interpreted as follows:

1. “Bond” means a long-term debt security such that the bondholder has legal rights as guaranty to get paid back their invested principal with interest as agreed.

Part III

Securities Issuance and Public Offering

Section 1

Securities Issuance

Article 15. Criteria for securities issuance

Any companies established in accordance with Lao Enterprise Law, wishing to issue securities for public offering, shall meet the following criteria:

1. Being established in any kinds of company [*sic*], except for a sole limited company;
2. Having a minimum paid-up charter capital at the time of registering for public offering at least two billion kip [*sic*] in book value;
3. Having sound financial performances [*sic*]; having not accumulated losses [*sic*]; being profit-making in the year preceding the year of such registration for offering; and its financial statement shall be audited by an external certified auditing firm. Additional conditions for offering bonds to the public, the enterprise shall not have overdue debts over than [*sic*] one year up to the year of registration for offering;
4. Other criteria and conditions as stipulated by the Office.

The Commission shall be granted the authority to formulate the regulations concerning overseas issuance and public offerings of any companies located in Lao PDR and any companies wishing to make an [*sic*] public offerings in Lao PDR.

E. Legal Framework of Investor Protection

1. Contract Law

The *Contract Law* was adopted by the National Assembly in 1990. It provides the conditions of written contracts and definitions of parties related to specific contracts such as loan contract and lease contract.

2. Bankruptcy Treatment and the Bankruptcy Law

The *Law on Bankruptcy of Enterprises* (also known as the *Bankruptcy Law*) was adopted by the National Assembly in October 1994, and promulgated by the President in November of 1994. It stipulates the comprehensive treatment of a bankrupt enterprise, covering bankruptcy petition, control of assets under the Asset Committee assigned by the court, meetings of creditors, reorganization of enterprises, liquidation of assets and distribution of assets. According to Art. 15 of the law, the Asset Supervision Committee comprises of creditor and debtor representatives, court and financial authority employees, as well as workers' representatives of the debtor enterprise. The rights and duties of the Asset Supervision Committee are set out in Art. 18 and include the determination of the debtor's assets and liabilities and the debts owed to each creditor. The Asset Supervision Committee is liable to the court regarding the performance of its duties.³

3. Auditing and Accounting

a. Enterprise Accounting

All enterprises are required to produce financial statements, which mostly should follow international accounting standards. There are exceptions, however, for small enterprises to use a simplified accounting system. At present, enterprises apply the Laos Accounting Manual (LAM) issued by the MOF; LAM is a set of instructions using accrual basis accounting designed for local tax submission purposes.⁴

b. Bank Accounting

Under the *Decree on the Accounting of Lao PDR* and the provision on “Financial Institutions under the Authorization of the Bank of Lao PDR,” banks have to submit annual financial statements through a registered auditor to the BOL. With the assistance of IMF, BOL provides a comprehensive and detailed format of financial statements, which banks have to follow.

³ For easy reference, details may be found in the website of the Japanese Embassy in Lao PDR (www.la.emb-japan.go.jp/jp/laos/Law_on_Bankruptcy_&_Decree.pdf).

⁴ PriceWaterhouseCoopers. 2008. *Similarities and Difference: A Comparison of IFRS and Thai GAAP, Vietnamese GAAP, Cambodian GAAP and Laos GAAP*. http://www.pwc.com/en_VN/vn/publications/assets/similarities_and_differences_gaap.pdf

IV. Foreign-Investment Related Laws and Exchange Control

A. Foreign Investment Law (1994)

The *Foreign Investment Law* governs the promotion and management of foreign investments (see Appendix 4 for the entirety of the law).

B. Cross-Border Portfolio Investment

BOL regulates cross-border capital and money market transactions. Inward remittances and repatriation of portfolio investments are principally allowed for both residents and non-residents. The International Monetary Fund's (IMF) Annual Report on Exchange Arrangements and Exchange Restrictions for the Lao PDR, which is available only in hard copy, summarizes the latest regulations on portfolio investments.

For capital inflows, all capital transactions are subject to authorization from BOL. For capital outflows, resident investors are allowed to invest abroad, subject to the *Law on the Promotion and Management of Foreign Investment*. Foreign investors are allowed to repatriate profits, capital gains, and other income upon full payment of duties, taxes, and other fees. Repatriation of funds may be done through a bank in the Lao PDR.

C. Currency Exchange Controls

Lao PDR maintains a managed floating exchange rate system. Foreign currency exchanges are regulated and managed by BOL under *Presidential Decree Law No. 01/P, March 17, 2008 on Governing the Management of Foreign Exchange and Precious Metals*, and related regulations. By using managed floating exchanges rate system, BOL carefully monitors and, at times, intervenes in the foreign exchange market to maintain stability.

Licensed financial institutions are allowed to buy and sell foreign exchange at freely-determined rates, provided the spread between buying and selling rates is below 2%. All international cash transfers require authorization from the Bank of the Lao PDR (BOL). The IMF's Annual Report on Exchange Arrangements and Exchange Restrictions for Lao PDR, available only in hard copy, discusses currency exchange controls.

1. Import and/or Export of Currencies

Residents and non-residents may bring in or take out foreign currency. Amounts exceeding \$5,000 or its equivalent are subject to customs declaration and BOL approval. Non-residents are only authorized to take out foreign currency up to the amount they declared upon entry. Import and export of Lao kip in excess of KN5 million requires BOL authorization.

2. Domestic and/or Foreign Currency Accounts

Residents and non-residents are allowed to hold Lao kip and foreign currency accounts locally. Withdrawals exceeding \$10,000 or its equivalent require approval of authorized banks and must be reported to the BOL.

3. Borrowing and/or Lending

Domestic and foreign currency lending and/or borrowing among residents and non-residents is controlled. All transactions are subject to BOL approval. Foreign investors may borrow revolving credit capital from local commercial banks.

D. Taxation

The Lao PDR tax system consists of direct and indirect taxes. Indirect taxes include turnover taxes and excise tax. Direct taxes include profit tax, income tax, minimum tax, and various fees and charges.

The Lao PDR applies a special tax regime to foreign investors that includes reduced rates, tax exemptions or holidays, a flat-rate profit tax of 20%, and a 1% import levy. Art. 30 of the *Tax Law* states that “lending interests, bond or shares interests” are included in the list of tax-exempt incomes. Interest paid are considered expenses that can be deducted from annual taxable profits. Detailed descriptions of the Lao PDR tax system and the special tax regime for foreign investors are accessible through the DDFI website.⁵

⁵ Department of Domestic and Foreign Investment. <http://www.invest.laopdr.org/tax%20law.htm>

V. Market Regulation and Infrastructure

A. Bond Operation in Lao PDR

1. Primary Market

In the primary market, there are three types of method of operation of T-bills and BOL bonds: interest value, auction value, and over the counter. Bond interest calculations are classified into two types: discount and coupon.

2. Secondary Market

Trading in the secondary market is done through 14 days of repurchase agreement, discount or outright agreement, and collateralised lending.

B. Inter-bank Market

An inter-bank market has played an important role recently in the development of the financial market, compared with the last 10 years when trading was only between commercial banks and the BOL. BOL occasionally provides liquidity for commercial banks that hold T-bills through: 1) repurchase agreement (repo), 2) discount, and 3) collateralised lending. BOL started such operations by practicing. There is no written notice or announcement that notifies BOL's T-bill operations to the banks.

1. Repurchase Agreement

BOL and a commercial bank sign an agreement that BOL purchases T-bills from the commercial bank, and the commercial bank repurchases the T-bills from BOL after 14 days. The agreement follows the same format for any commercial bank.

2. Discount

Discount is an operation wherein BOL purchases T-bills from a commercial bank without a repurchase agreement. BOL may hold the T-bills until its maturity or re-sell it to another commercial bank.

3. Collateralised Lending

BOL may grant loans to account holders against the security of valuable documents

(as defined in Art. 36 of the *Law on the Bank of the Lao PDR*), with repayment periods not exceeding 183 days, and on terms and conditions determined by the BOL.⁶

As there are very limited secondary transfers of T-bills with transactions only between BOL and commercial banks, physical delivery of the certificates is still a common practice for settlement.

C. Auction Process

T-bills auction participants are comprised of commercial banks and financial institutions. Participants will be required to open an account in BOL and at any banks in Lao PDR. The completed auction process is carrying the number of indicated values (amount, maturity, date of auction results, date of settlement and clearing, auction steps).

Figure 5.1 The Auction Process

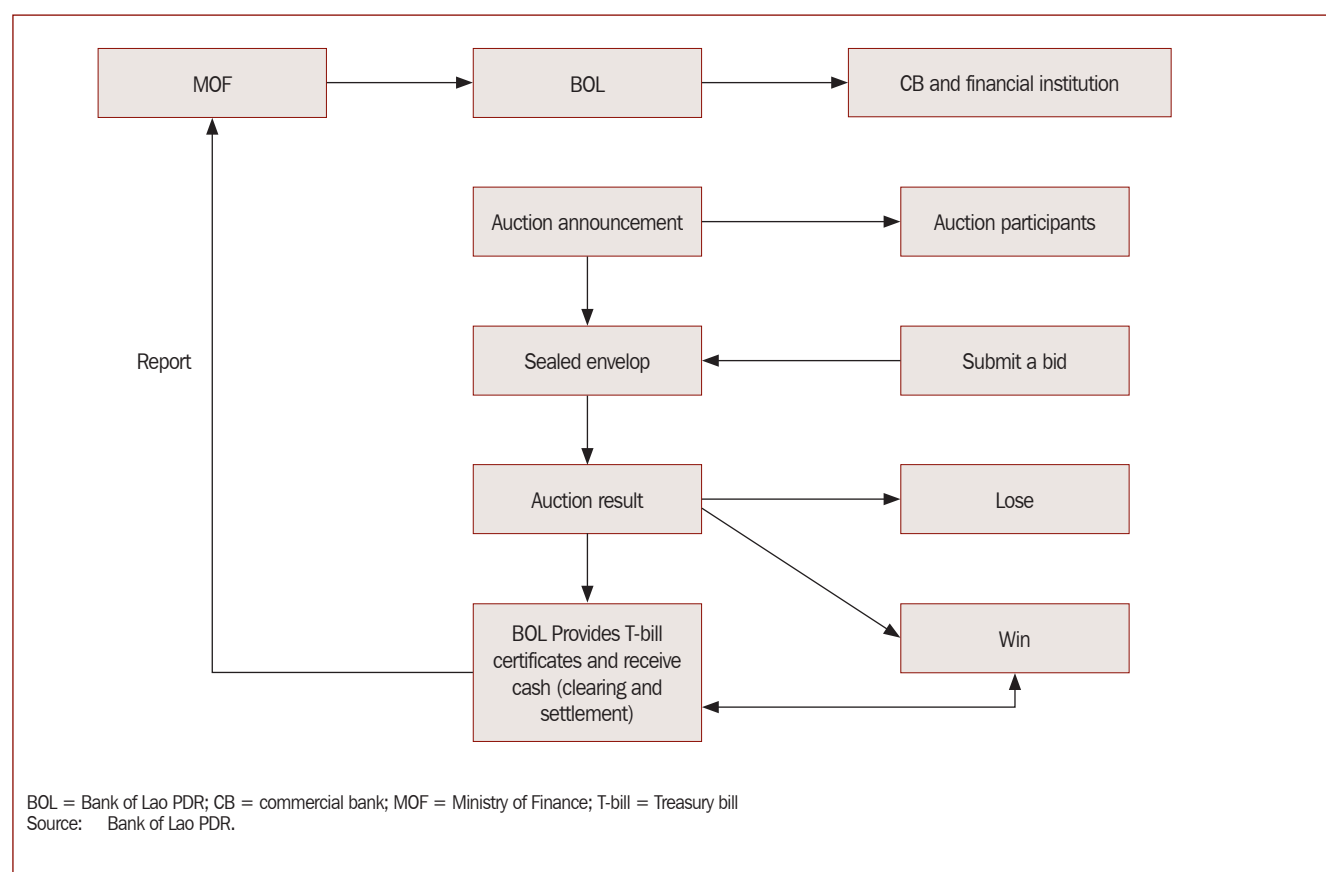

⁶ Government of Lao PDR. *Law on the Bank of Lao PDR*. http://www.la.emb-japan.go.jp/jp/laos/Law_on_Bank_of_the_Lao_PDR.pdf

D. Settlement and Clearing

T-bills are issued as physical certificates. After the auction of T-bills, BOL passes the certificates to successful bidders. The auction process from bidding to settlement is as follows:

Auction begins on a Thursday when auction participants submit a proposal in a sealed envelope to BOL. The Auction Committee decides which bids are successful. On Friday, BOL announces the results, setting the price (discount rate) and the amount to the successful participants, and serves a notice of failed proposal to unsuccessful participants.

On the Tuesday after the auction, the settlement process begins. BOL provides the T-bill certificates and receives cash, usually withdrawn from deposits made to BOL.

1. Settlement of T-bill

The settlement and clearing of bonds are done after auction results have been made and successful participants are informed within 2 business days (T+2).

2. Renewal (Roll-over) of T-bill

When the maturity of a T-bill is reached, BOL notifies MOF when the issue is going to be due. If MOF decides to renew the T-bill, it will then give a notice on the amount and interest rate for the renewal. Holders of such T-bill (usually commercial banks) bring the certificates to BOL. BOL writes down the renewed date and date of maturity, and marks it with a stamp saying “Renew” at the back of the certificate. BOL then returns the certificate to the holder as well as the coupon for the renewed T-bill. BOL pays the coupon for the renewed T-bill by crediting the commercial banks’ account opened with BOL.

E. Taxation and Tax Exemption

According to the *Tax Law*, which was legislated in 2005, interest from bonds or government debentures, as well as those from deposits, are exempted from income tax. Whether capital gain (or loss) from sales of bonds or government debentures is recognized as taxable income (or loss) is ambiguous; profit from share sales, however, is taxable income.

VI. Budget, Debt, and Cash Management of the Ministry of Finance

A. Relevant Departments of the Ministry of Finance

Under the MOF, National Treasury, the departments of budget, tax, customs, external financial, and fiscal policy are major organizations that are relevant to management of budget, debt and cash. The Budget Department is responsible for drafting annual budget plans, which are subject to adoption by the National Assembly, and drafts semi-annual budget plans, which are reported to the National Assembly. It also prepares quarterly budget plans for internal use within MOF by reflecting updated status of budget executions.

National Treasury is organizationally part of the MOF. It has 16 provincial treasury offices, one office in Vientiane Capital and more than 100 district-level treasury offices, and is staffed with more than 900 employees. Provincial treasury offices have dual reporting lines, i.e., to headquarters and to the provincial governor. The headquarters of National Treasury in Vientiane capital consists of seven divisions: cash division, revenue division, accounting division, expenditure management division, mobile fund and debt division, inspection division and personnel and administrative division. At present, the mobilize division and debt division are responsible for T-bills.

The Tax Department and Customs Department are responsible for the collection of taxes and customs, respectively. The Tax Department has nearly 16 provincial offices, one office in Vientiane Capital and 144 district offices nationwide.

The External Financial Department is responsible for disbursement and debt services of projects loaned by multilateral and bilateral donors. The Fiscal Policy Department is also engaged in data collection and analysis of budget for policy formation and statistical purpose.

B. Budget Management and Government Securities

The annual budget approved by the National Assembly defines how much the difference between revenue and expenditure (deficit) shall be, and how much shall be mobilized by foreign and local debt financing. As shown in Table 6.1, the budget

difference or deficit for the fiscal year 2010–2011 is minus KN1,802 billion, KN33 billion of which is mobilized through local debt financings, i.e., issuance of treasury bills whose maturity is up to a year. Triangle and recapitalization bonds seem to be out of scope of budgeting requirements. While majority of treasury bills and all of triangle bonds have been renewed with coupon payment upon maturity, such renewal of government securities, hence, outstanding volume of government debt may not be properly reported to the National Assembly.

Table 6.1 Approved Budget and Deficit Financing, FY2010–2011 (KN billion)

Item		Fiscal Year 2010–2011
Total Revenue		4,005
Total Expenditure		5,807
Difference (Deficit)		-1,802
Financing	Foreign debt financing	1,769
	Treasury bills	33
Source: Ministry of Finance		

C. Debt Management

The MOF has a two-fold responsibility when it comes to debt management. The Treasury is responsible for managing domestic debt, while the External Financial Relations Department manages foreign debt, which is larger in terms of outstanding volume. The External Financial Department has an external debt service plan, which, however, is not yet shared with the National Treasury. The amount and timing of repayment of the external debt's principal and interest is communicated to the National Treasury through a payment order from the External Financial Department. Under the current procedure, only BOL knows or aggregates the outstanding volume and debt service schedule of domestic debt. As an issuing agency, BOL notifies the National Treasury of every repayment about a month prior to maturity, a procedure which can be amended to give the National Treasury ample time to prepare for the payment order for domestic debt servicing. Moreover, the National Treasury needs to apply with the Budget Department for coupon payments of treasury bills and triangle bonds (it renews the principal at most), but it does so only once a month by combining the different maturities of a particular month into one application. Therefore, by the time the National Treasury receives approval from the Budget Department and pays through BOL to institutional investors, most, if not all, deadlines or maturity dates of that particular month have lapsed already. This is too often called a delay in Lao PDR, but must be regarded as default in accordance with international standards.

As for treasury bills held by individual investors, commercial banks as agents periodically pay the interests ex-ante and then receive the reimbursement from BOL, who pays such due on behalf of the National Treasury temporarily. Since the approval process for government debts through the relevant parties may take time, commercial banks and other intermediaries have taken it upon themselves to pay out the debt interest first and then seek reimbursement from BOL. Nevertheless,

while BOL reports and requests reimbursement dues to the National Treasury every quarter, it receives reimbursements only if the National Treasury has some surplus of cash. Therefore, BOL holds an account receivable of around KN30 billion for this operation alone. In the meantime, the National Treasury fulfills redemption to individual investors upon maturity through BOL and commercial banks.

VII. Review of Fixed-Income Securities

T-bills are issued in accordance with the annual budgetary plan approved by the National Assembly. BOL's Banking Operations Department facilitates the auction.

A. Historical Background

Government Securities were initially issued in Lao PDR in 1990 to control rising inflation and to absorb excess liquidity in the economy. The first government securities issued in June 1990 were via Treasury Certificates, which amounted to KN2 billion, with 3 months (renewable) maturity priced at 48% per annum. In November of the same year, inflation gradually decreased. Hence, the government reduced interest rates for Treasury Certificates issued from November 1990 to October 1991 by 12.5%, or pricing it at 42% per annum. By July of 1992, MOF was able to sell KN2 billion worth of 3-months Treasury Certificates to state-owned banks. The objectives MOF posed for the issuance of government securities were deemed effective, and with this the government allowed BOL to develop its own monetary instrument totaling to KN1.5 billion. In November 1991, the first BOL bills—amounting to KN200 million, with 6 months maturity at 20% per annum—were issued.

Until November 1993 seven more succeeding BOL bills were issued with amounts ranging from KN200 million to KN400 million, all of which to mature after 6 months and priced at 20% per annum, and the last batch which was priced at 15% per annum.

In view of the facts that the issuance of government securities were effective monetary policies for Lao PDR, and that the MOF was agreeable in issuing debt instruments to mobilize funds locally, the central bank pushed for a Treasury bills auction in 1994.

B. Treasury Bills

1. Issuer

The MOF started issuing Treasury bills as a means to meet Lao PDR's fiscal deficits. Currently, T-bills have maturities ranging from 3 months to 1 year.

2. Investors

Investment in T-bills is open to financial institutions, state-owned enterprises (SOEs), private companies, and individuals. At the time of the ADB market visit in June 2011, T-bills with 1-year maturity were priced at 7.5% per annum, whereas current account deposits at banks did not yield any interest, regardless of principal and/or tenor. Corporations find investment in T-bills favourable compared with bank deposits or savings relative to the interest rate it offers. T-bills are priced at 7.5% per annum with 1 year maturity.

MOF caps or sets the ceiling of coupon rates, depending on the market scenario. At present, T-bills are priced at 14% to 16% per annum, whereas current deposits to banks of a corporation do not yield any interest, regardless of principal and/or tenor. However, investors are reluctant to use T-bills as part of their investment portfolio because T-bills, by practice in the country, are not demandable at once; rather it is renewable and extendable, subject to the budget and liquidity status of MOF. T-bills can be extended usually up to 3 months to 1 year. Extended and renewed T-bills are given a relatively higher coupon rate relative to its initial rate.

In 2005, the total Treasury bills issued in Lao PDR amounted to KN33 billion, with a coupon rate (on the average) of 15%, all of which will be maturing by 2006. Outstanding triangle bonds maturing in 2005 and by 2006 amounted to KN189.15 billion.

3. Redemption of T-bills

Upon issue, T-bills were allocated to commercial banks and further transferred or sold to non-banks. The National Treasury of the MOF sends to the Central Bank information on which T-bills that had been issued are subject for redemption. Usually, these bills are those with high interest rates and bear an earlier tenor, i.e., 6 months. The amount for redemption depends on the ceiling established and based on the budget available. Once a month commercial banks go to BOL to ask for T-bills redemption. BOL then advances payment to the commercial banks on behalf of the MOF. After which, the MOF issues a letter similar to a Promissory Note (PN) stating when they can pay for the advances BOL made on their behalf for a particular T-bill.

For coupon payments, where T-bills have been sold or transferred by commercial banks to non-banks, the commercial bank advances the coupons for the MOF. After which, commercial banks report to BOL the advances they made on behalf of MOF, and BOL records these advances made and later on reports to the MOF. Unlike the advances made by BOL on behalf of MOF, the MOF need not issue a letter (similar to a PN) to BOL regarding advances made by commercial banks. See Figure 7.1 for a schematic diagram of this process.

This reminder is done on a quarterly basis through a report. The MOF, before making payments, first reconciles the details with BOL, particularly on the amount for payment. Since majority of T-bills are sold to commercial banks, these banks also work as an agent in the sale or transfer of T-bills, although there is no law supporting such function. T-bills are allocated among commercial banks in accordance with their capacity. Such capacity is based on their network (i.e., number of branches) and willingness and ability to advance for the coupon payments on behalf of the

government. Most of the T-bills are allocated for distribution or sales to the following banks: Banque Pour Le Commerce Exterieur Lao (BCEL), Lao Development Bank (LDB), and Agriculture Promotion Bank (APB).

Figure 7.1 Process of Coupon Redemption of Treasury Bills Issued to Commercial Banks

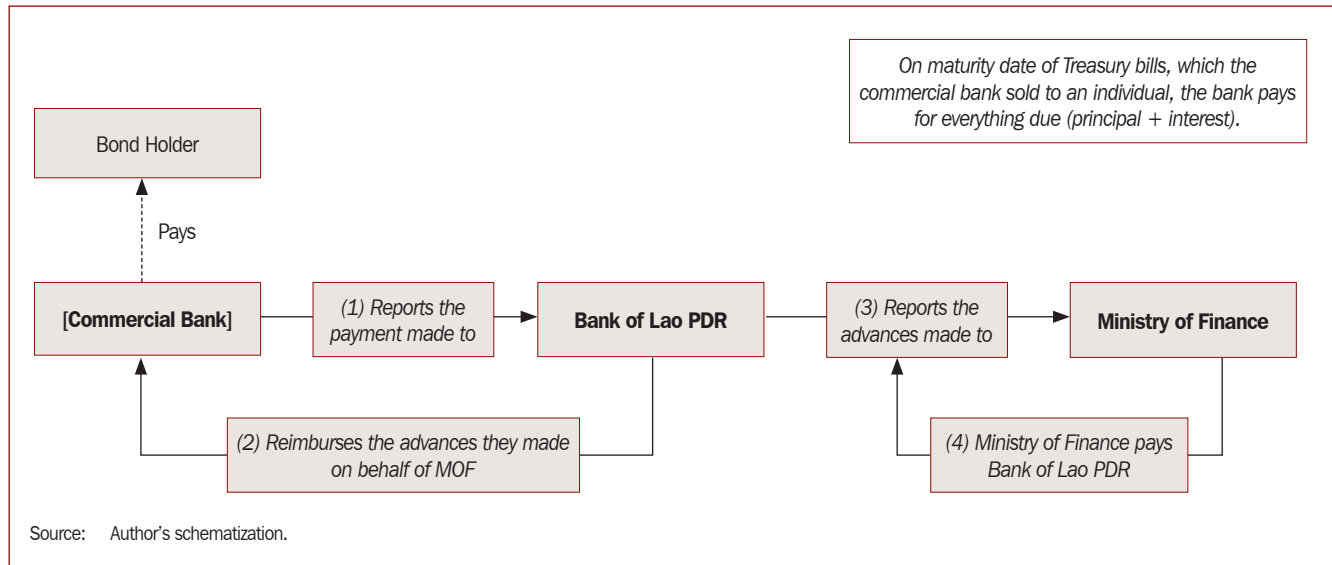

In August 2011 there were KN1 billion worth of T-bills redeemed. The National Treasury pays for the interest of renewed T-bills; the MOF, on the other hand, is responsible for interest payments of primary issued and renewed T-bills. BOL sends a reminder in the form of a letter a month before the due date of payment of interest to the MOF. Upon BOL's receipt of the Payment Order (PO) from the Treasury, BOL pays the commercial banks concerned by crediting the payment to their respective accounts with the central bank. Receipt of the PO used to be late for a day or several days after maturity date under previous procedures; with a timelier receipt of such document, if not a few days before date of payment, PO is received on transaction date.

C. Recapitalisation Bonds

By end of 2005, the MOF had issued a maximum of KN200 billion of recapitalization bonds on behalf of two commercial banks, BCEL or Foreign Trade Bank and LDB. The said government bonds had a maturity period of 5 years at a fixed per annum rate of inflation (approximately 7% to 10%) plus 1%. The issuance of recapitalisation (recap) bonds did not only aim to restructure and recapitalize the said state-owned commercial banks, but this activity also positively resulted in the stabilisation of money supply in the economy. In addition, in early September 2005, APB's capital restructuring via recap bonds was evaluated and was the subject of further discussion between the MOF and APB's management.

VIII. Immediate Action, Roadmap, and Work Programs

There are five challenges identified to jumpstart the bond market.

A. Action 1: Strengthening Capacity of the Ministry of Finance

1. Strengthening Debt Management of the National Treasury

Debt management of the National Treasury needs to be strengthened, especially to safeguard the redemption of government securities. Although the domestic debt has to be managed by the National Treasury, it seems that BOL, rather than the National Treasury, is better prepared for and aware of the debt obligations. This resulted in delays, if not defaults, of interests for payments of Treasury bills and triangle bonds. This can be also addressed in the short term if the National Treasury develops and maintains the issuance, recordkeeping, and repayment scheduling, and if it applies interest payments in advance and more frequently to the Budget Department. Such practices may help the National Treasury aggregate the outstanding volume of government debt and report it to higher authorities.

At present, National Treasury is not notified of the repayment schedule of external debts by the External Financial Department, until it receives a repayment order. Hence, it is unable to prepare for the repayment in advance, leading to extension of such, or delay of, other payments. This can be addressed in the short term, if only the External Financial Department produces and updates the long-term debt service plan and its monthly breakdown for the forthcoming years, and shares it with the National Treasury. In the long run, the government may want to finance infrastructure projects with long-term benefits by issuing government bonds with mid- to long-term maturities. When the government wants to issue a significant volume of such government bonds in a regular manner, the establishment of debt management division or department, inside or outside the National Treasury, needs to be examined. Such a specialized division or department shall be responsible for issuing, auctioning, settling, recordkeeping, and repaying government securities. The rationale behind allowing such a single division or department to fulfill sales and redemptions in one place is that it can closely monitor market response upon auction and redemption. It is essential for the MOF, as the dominant and major

issuer of bonds, to know market sentiments directly and immediately to better examine issuance strategy such as timing, volume, terms, targeted coupon rate, among other things.

Among member countries of the Association of Southeast Asian Nations, for example, Viet Nam and the Philippines have debt management functions inside their respective Treasuries, while Thailand has a public debt management office besides the Treasury under its MOF.

2. Strengthening Cash Management of the National Treasury

Cash management of the National Treasury needs to be strengthened, especially to know its cash position and for smooth budget execution. Towards this end, usage of the banking system for treasury operations needs to be expanded.

While tax payments by Large Taxpayer Units (LTUs) and Medium Taxpayer Units (MTU) are collected directly by the headquarters of the National Treasury through checks, provincial treasury offices still continue to receive cash from small and very small taxpayers. Provincial treasury office may have the incentive and room to hold, spend, misplace and/or delay transfer of such cash to headquarters at least in part; this is based on the premise that they have their own spending needs, which are too often unmet by budget release and transfer processes, and that there is no reconciliation between reported data and cash. Such practices of not fully remitting to the headquarters, in turn, make the process of releasing their budgets more difficult. To curtail this cycle, cash transactions need to be shifted from the National Treasury to BOL and/or commercial banks, wherever possible. Bank staff, in general, may be better trained to receive cash, issue and clear check, and report and reconcile such transactions, requiring all taxpayers to pay through commercial banks, which act as revenue agents. This will decrease underreported or unaccounted cash transactions in the treasury system as a whole.

As for tax, the difference in office networks may matter. In fact, the Tax Department has nearly 16 provincial offices and 144 district offices nationwide, while the commercial bank with the largest branch network, APB, covers all the provinces but not the districts through its branch network. The geographical coverage by province and district of the treasury, banks and postal savings needs to be examined.

As for customs, the difference in operating hours may matter. While customs offices may open on a 24-hour-and-365-day basis, depending on entry point, bank branches usually open during weekdays only. Revenue agents may be required to locate their counter inside the customs area and open it in consistency with customs operation hours. In addition, checks clearing outside Vientiane needs to be examined as well. In return for administrative burdens, revenue agents may be given a service commission or some prefixed privileges.

B. Action 2: Developing the Legal and Regulatory Framework for Corporate Bonds

No business company, such as a public limited company, besides a bank has so far issued and sold corporate bonds at least through public offering. The *Business Law* broadly stipulates that only a business company (public limited company) is entitled

to issue and sell corporate securities such as shares and bonds to the public. This means that public limited companies including full or quasi-SOEs may be able to issue corporate bonds. However, the *Business Law* as well as other laws provide for neither procedures nor criteria for a public limited company to issue corporate bonds. Meanwhile, the *Banking Law* allows banks to issue bank debentures, and the APB has sold savings bonds to the public.

At the early stage of bond market development when both issuers and investors are not familiar with corporate securities, it is recommended that the regulator approves who can issue corporate bonds and how much. Even with no corporate bond market currently in place in Lao PDR, several business companies (public limited companies) are interested in issuing corporate bonds for large-scale investment projects such as infrastructure. The government therefore needs to develop the legal and regulatory framework for corporate bonds. More concretely, it needs to:

- i) elaborate regulations on application procedures, approval criteria, and information disclosure;
- ii) improve law provisions such as in the *Bankruptcy Law and Secured Transaction Law*, and;
- iii) designate and strengthen the regulators, MOF and/or BOL, as watchdogs not only of the corporate bond market but also of the securities market as a whole.

C. Action 3: Developing the Inter-bank Market

Although the government continues to issue debentures for a few years, and more investors are interested in buying debentures, there is very limited trade of such debentures, and most (if not all) trades are done between BOL and commercial banks, as part of BOL operation of T-bills. Therefore, developing the inter-bank market for government debentures is important at this stage, because it is the most basic market structure and critical prerequisite for the government bond market. Without a liquid inter-bank market, banks would have difficulty to take positions on T-bills or any other government securities, and BOL may also reach its full capacity if it continues to take positions on T-bills whenever it is asked by banks at the current rate. Current market operations by BOL work as an initial step to develop the inter-bank market. Next steps would follow as described below.

Firstly, BOL may systemize its open market operations of T-bills by formalising the rules and conditions as well as procedures, and announcing them by issuing notices. By stating its support to market participants clearly, BOL shows its policy to develop the inter-bank market, which should encourage banks to take active positions of T-bills.

Secondly, BOL may expand its role for the settlement of T-bills by working as the central custodian or securities depository to make clearing and settlement more efficient. It is necessary especially when secondary trading among banks becomes more active. As of September 2005, most of the transactions occur only between BOL and a bank involving many transactions. Once the inter-bank trading becomes more active, transactions become many versus many. Such situation makes efficient

clearing and settlement an indispensable function. BOL has such capacity, as it already operates T-bills auctions and open market operations, and holds accounts of all the commercial banks as the central bank.

Thirdly, BOL, in collaboration with the MOF, may create and issue detailed guidelines on how banks can operate a securities business firstly as dealer for itself, secondly as broker-dealer of government securities, and thirdly as underwriter of non-government securities. Risk management is essential when functioning as a dealer and as a broker-dealer while being an underwriter requires an effective firewall between banking businesses. Without clear guidelines, banks may take excess risks without proper management, and may cause significant loss within a short time. Furthermore, when private enterprises start issuing corporate bonds, banks may be involved in conflicts of interest and in insider trading when using information obtained through banking operations.

D. Action 4: Developing Institutional Investors

The development of institutional investors, especially long-term investors, is essential for the development of the bond market.

1. Commercial Banks

For banks, establishment of the inter-bank market, or at least BOL operation as a “last resort,” is essential to invest in bonds as their liability is short-term. Currently, T-bills are purchased mostly by the state-owned commercial banks, but other banks who have excess liquidity would be encouraged to consider T-bill investment.

It is expected that if BOL upgrades its roles and functions in the government securities market, as described in the chapter on legal and regulatory framework, a wider range of the commercial banks can become active in the market. For example, banks can be confident to invest in T-bills when they know BOL stands as a last resort whenever banks need immediate cash. Also, setting clear guidelines on banks’ operations of their securities business would become helpful for banks to work as dealers. In addition, bank supervisory regulations have unexpectedly significant effects on the banks’ investment activities. As an example, recognition of T-bills as a risk-free asset when calculating the required capital as the current practice goes relieve banks to allocate capital when investing in T-bills, thus encouraging them to do so. BOL may consider introducing additional treatments for T-bills (e.g., allowing banks to count T-bills as reserve cash-equivalent assets).

2. Postal Savings Institutions

Although in some developed countries postal savings institutions are some of the major investors in government securities, at this stage in Lao PDR, it is not expected to happen nor necessary yet. The Lao Postal Savings Institution invests in high-return investments such as employee loans, and the amount of the loans becomes comparably significant to the amount of the savings. In the future, when savings becomes more developed as it plans to expand the network nationwide, and the Institution becomes more cautious about the risks of the employee loans, then it may consider investing in government securities.

3. Pension Funds

The Social Security Organization (SSO) may upgrade its Social Security Fund's (SSF) fund management skills covering its investments in government securities. Issues to be addressed include the capacity of the management of SSO to manage SSF investing in various asset classes while considering liability structure and skills on asset liability management (ALM).

4. Insurance Companies

They said that insurance companies started to invest in T-bills in 2005, but it will do so more aggressively if it starts the life-insurance business. The development of the life-insurance business is one of the essential supporting factors for the development of the bond market. In Lao PDR, at this stage, careful study and updating or revision of the existing regulatory framework would be necessary before life-insurance can be implemented.

E. Immediate Action 5: Developing the Securities Business

As bonds are mostly traded on over-the-counter (OTC) market or quote-driven markets, rather than at an exchange or auction markets, the development of well-trained dealers becomes essential especially to develop the bond market. At this stage in Lao PDR, allowing and encouraging bank dealers to trade among themselves would be practical and reasonable. By encouraging inter-bank dealing, BOL would eventually step back to work as a “last resort” for the government securities market, taking position only when no counterparts within banks are available. The level of market intervention depends on the market conditions, however. As an example, when the market shrinks due to lack of confidence or depending on seasonal fund shortage, BOL may take a more aggressive role.

In order to develop banks' securities business as intermediaries, again, the BOL may take further steps to expand its roles and functions, namely: systemizing its open market operations; working as the central custodian and/or securities depository; and issuing detailed guidelines on securities business by banks.

F. Roadmap

In terms of the four “I”s—issuer, infrastructure, investor and intermediary—and mainly from the viewpoint of the MOF and BOL, the roadmap for bond market development in Lao PDR is suggested as follows.

Table 8.1 Roadmap of Bond Market Development in Lao PDR (2011–2020)

4 “I”s	Short Term (2011–2012)	Medium Term (2012–2016)	Long Term (2016–2020)
Issuer	<p>Immediate Action 1: Strengthening Capacity of MOF (See work programs for details)</p> <p>Immediate Action 2: Developing the Legal and Regulatory Framework for Corporate Bonds (See work programs for details)</p>	<p>Setting up a debt management section under the MOF.</p> <p>Developing the legal and regulatory framework for a variety of structured bonds such as convertible bonds, ABS and MBS.</p>	<p>Developing a primary dealership for government securities.</p> <p>Developing the legal and regulatory framework for credit-rating agencies.</p>

continued on next page

Roadmap of Bond Market Development in Lao PDR continuation

4 "I"s	Short Term (2011–2012)	Medium Term (2012–2016)	Long Term (2016–2020)
Infrastructure	Immediate Action 3: Developing Inter-bank Market (See work programs for details)	Developing the clearing and settlement infrastructure for government securities, serving as including post-trade information system, as well.	Introducing the primary-dealer system for government securities.
Investor	Immediate Action 4: Developing Institutional Investors (See work programs for detail)	Developing the legal and regulatory framework for a variety of investors such as investment funds.	Developing the retail channel of government securities.
Intermediary	Immediate Action 5: Developing the Securities Business (See work programs for detail)	Enhancing bank-dealers into broker-dealers who can provide brokerage services including underwriting.	Introducing the primary-dealer system for government securities.

ABS = asset-backed securities; MBS = mortgage-backed securities; MOF = Ministry of Finance
Source: Bank of Lao PDR, Ministry of Finance.

G. Work Programs for 2011–2012

During the short-term (2006–2010), mainly from the viewpoints of the MOF and BOL, the work programs to jumpstart the bond market in Lao PDR are shown in Table 8.2. The MOF and BOL also need to enhance the prerequisites and enabling conditions such as financial stability and market confidence in general.

Table 8.2 Work Programs for Jumpstarting the Bond Market in Lao PDR (2011–2012)

Challenges	Work Programs for the Short Term (2011 to 2012)
Immediate Action 1: Strengthening the Capacity of MOF	<p>MOF shall fulfill the redemption of government securities on maturity by upgrading recordkeeping and repayment scheduling.</p> <p>MOF shall stop renewing matured government securities and instead reissue another round of government securities, if necessary.</p> <p>MOF shall prepare and disclose the auction calendar of government securities by frequenting cash projection through the monitoring of budget execution and tax and customs collection.</p> <p>MOF shall expand the usage of the banking system for tax and customs collection and for the treasury's cash operations.</p>
Immediate Action 2: Developing the Legal and Regulatory Framework for Corporate Bonds	<p>MOF and BOL shall define each regulatory regime on corporate bonds and securities market.</p> <p>MOF and/or BOL shall elaborate regulations on application procedures, as well as approval criteria.</p> <p>MOF and/or BOL shall provide the requirements for accounting, auditing and information disclosure for corporate bond issuers.</p> <p>MOF shall take lead to improve some law provisions such as the Bankruptcy Law and Secured Transaction Law.</p>
Immediate Action 3: Developing the Inter-bank Market	<p>BOL shall systemize its open market operations of T-bills by formalizing the rules and conditions, as well as procedures, and announcing themselves by issuing notices.</p> <p>BOL shall expand its roles for the settlement of T-bills by working as the central custodian or securities depository to make clearing and settlement more efficient.</p>
Challenge 5: Developing the Securities Business	<p>BOL and MOF shall create and issue detailed guidelines how banks can operate securities business firstly as a dealer.</p>
Immediate Action 4: Developing Institutional Investors	<p>BOL and MOF shall create and issue detailed guidelines how banks can operate a securities business firstly as a dealer</p> <p>MOF and SSO shall upgrade SSF's fund management skills covering its investments in the government securities.</p> <p>MOF shall develop the legal and regulatory environment for life-insurance business.</p>

BOL = Bank of Lao PDR; MOF = Ministry of Finance; SSF = Social security Funds; SSO = Social Security Organization
Source: Bank of Lao PDR, Ministry of Finance.

IX. Market Statistics

Due to the nature of the nascent bond market in Lao PDR, market statistics are very limited at this stage. The authors express their hope that as a result of the work of the ASEAN+3 Bond Market Forum (ABMF) and the excellent work of its members from Lao PDR, some basic statistics may be available in due course.

Contact (ADB Consultant):

Prof. Shigehito Inukai
Faculty of Law, Waseda University
1-6-1, Nishiwaseda, Shinjuku-ku, Tokyo, 〒169-8050
Tel & Fax (Direct): + 81-(0)3-3202-2472
Mobile: +81-(0)80-3360-7551
E-Mail: shige.inukai@me.com

Appendixes

Appendix 1: Decree on Securities and Securities Market

Box A1.1 Decree on Securities and Securities Market

Prime Minister's Office
Ref. No. 255/PM
Vientiane, 24 May 2010

The Government's Decree on Securities and Securities Market

- Pursuant to Law on the Government of the Lao PDR, No. 02/NA, dated 6 May 2003;
- Pursuant to Enterprise Law, No. 11/NA, dated 9 November 2005;
- Upon the proposal set forth by the Chairman of the Securities and Exchange Commission, No.001/SEC, dated 18 March 2010.

The Prime Minister issues hereby the decree:

Part I **General Provisions**

Article 1. Objective

Decree on Securities and Securities Market prescribes principles and regulations on the establishment, and operations of the Securities and Exchange Commission, regulations on the establishment and operations of a securities exchange, regulations and supervisions of securities public offering and listing, and operations of securities companies in order to promote fund raising from the public, in order to ensure that securities-related activities in the market are conducted in a public, equal, transparent, in order and efficient manner and protecting investors' legitimate rights and interests.

Article 2. Securities and Securities Exchange

Securities mean a financial instrument which an issuer uses for the purpose of fund raising in order to finance their business operations. Securities shall include shares, bonds, and other kinds of securities as specified by the Securities and Exchange Commission.

The Securities Exchange shall serve as a center for trading of listed securities and shall be established in compliance with this Decree.

Article 3. Definitions of Terms

Defined terms in this Decree shall be interpreted as follows:

1. "Share" means the company's capital divided into portions of equal value certifying the lawful rights and interests of the shareholder over a part of the equity of the issuer.
2. "Bond" means a long-term debt security such that the bondholder has legal rights as guaranty to get paid back their invested principal with interest as agreed.

continued on next page

Box A1.1 continuation

3. "Listed company" means the company having their securities listed on a centrally organized market.
4. "Listed securities" means the permission granted to eligible securities to be traded on a centrally organized market.
5. "Public offering" means an openly offering for sale of securities by any methods of offering via a securities company to at least thirty investors, excluding institutional investors.
6. "Issuer" means a legal entity that is approved by the Office in order to offer its securities to the public.
7. "Prospectus" means a document published for the purpose of providing information and inviting the public to subscribe or purchase the securities issued by the issuer.
8. "Investor" means individuals and legal entities participating in securities investment, aiming at capital or financial gains.
9. "Institutional investor" means a legal entity, including commercial banks, insurance companies, financial leasing companies, securities companies, and other kinds of financial institutions as specified by the Office.
10. "Principal shareholder" means shareholders holding 10% or more of the total amount of the issuer's voting shares.
11. "Insider" means any principal shareholders, members of the Board of Directors and management titles, managers and employees of the issuer, the issuer's underwriter, management titles and officers of an Exchange, an auditor of issuing company, management titles and officers of the Office, who have access to internal information of the issuing company.
12. "Inside information" means any information regarding to the issuer that are not yet disclosed to the public, such disclosure would have great influence on its securities prices or investors' decisions.
13. "Securities company" means a financial institution licensed to undertake securities businesses, as specified in this Decree.
14. Securities business means securities brokerage, securities dealing, securities advisory, securities underwriting, and other securities-related businesses, as licensed by the Office.
15. "Securities brokerage" means the operation of a securities company acting as an intermediary to carry out securities buying or selling orders on behalf of the customers for brokerage fees.
16. "Securities dealing" means the securities company's engagement in buying and selling securities for its own account.
17. "Securities advisory" means the securities company's engagement in financial advisory and securities investment advisory.
18. "Securities underwriting" means the commitment made by an underwriter to help the issuer to complete procedures prior to an offer, to buy part or all of the securities issued by an issuing organization for resale or to buy the undistributed portion of the securities from the issuer, as agreed in an underwriting contract.
19. "Securities professional practitioner" means individuals passing a securities business qualification exams and receiving a Securities Practitioner License from by the Office.
20. "Securities depository" means the receipt of securities deposited by customers, safekeeping of customers' securities, [and] delivery of securities to customers and securities settlement.
21. "Exchange member" means a securities companies being established in accordance with this Decree and meeting membership requirements as specified by the Exchange.
22. "Customer account" means the account opened in a securities company by the customer in order to trade securities, and the person's name as stated in the Securities Depository Book has the legal rights to own any securities in the account.
23. "Commission" means the highest administration body of the Office of the Securities and Exchange Commission and being appointed in accordance with this Decree.
24. "Office" means the Office of the Securities and Exchange Commission.

Article 4. Securities Market Development and International Cooperation Policies

The Government of Lao PDR encourages individuals and legal entities to participate in the process of investment, operations and development in the securities market in order to mobilize long-term capital sources for the national socio-economic development.

The Government promotes international cooperation and relationship with friendly countries, based upon the principle of mutual benefits without any monopolistic conditions, in order for sharing lessons and experiences, exchanging information, attracting investment capital and technology transfer regarding to the securities and securities market in order to integrate the Lao capital market into the regional and global capital markets.

Article 5. Scope of Application

This Decree stipulates the regulations concerning any individual and legal entity on public securities offerings, securities business services, securities investment, and a securities market within the territory of Lao PDR.

Part II**Securities Supervisory Authority****Section 1****Securities and Exchange Commission****Article 6. Roles of the Securities and Exchange Commission**

The Securities and Exchange Commission acts as a secretariat for the Government in formulating necessary policies, strategic plans, regulations, management and supervision over securities and the securities market on a uniform basis.

continued on next page

*Box A1.1 continuation***Article 7. Organization Structure**

The Commission shall comprise of Chairman, Vice Chairman, and commissioners representing the sectors of finance-banking, justice, Secretary-General of the Commission, and other related sectors.

The Public Administration and Civil Service Authority shall study, draft and propose requirements and qualifications of the commissioners to the Government for its consideration and approval.

Article 8. Appointment and Removal

The Commission shall be appointed and removed from the office by the Prime Minister, and shall have a term of the office for five years and may be re-appointed.

Articles 9. Rights and Duties

The Commission shall have the following rights and duties:

1. To submit to the Government for promulgation of newly established regulations and amended laws, and strategic plans and policies of development on securities and the securities market.
2. To submit to the Government for promulgation of policies for the promotion and development of securities and the securities market.
3. To approve policies and plans on securities market development based upon the proposal by the Office.
4. To approve an annual operation plan and budget plan based upon the proposal by the Office.
5. To consider and grant licenses relating to the activities regarding securities businesses and the securities market based upon the proposal by the Office.
6. To approve necessary regulations relating to the activities of the Office.
7. To consider and approve changes relating to roles, duties and organization structure regarding the Office.
8. To propose [to] the Prime Minister for appointment or removal of Secretary-General of the Office.
9. To appoint or remove the positions for Deputy Secretary-General of the Office, Director of Division and Deputy Director of Division in the Office.
10. To consider and approve the appointment and recruitment of senior officials and employees equivalent and below any positions of Deputy Director-General, including awards and sanctions against the offenders.
11. To monitor and inspect the activities of the Office.
12. To report and propose the opinions on the securities-related conditions and a securities industry to the Government at a regular basis.
13. To carry out other rights and duties according to the Government assignment.

Articles 10. Working Method

The Commission shall perform the activities as agreed [in] decisions of the Meeting and shall have a meeting at least every two months. The Commission shall be granted the authority to define its roles and activities in further details.

Articles 11. Budget and Sealed Stamp

The Bank of the Lao PDR shall provide an annual budget to the Commission and its Office in order to perform their activities, including necessary equipments, infrastructure development and personnel training and development.

In the case that the Commission and its Office need further financial budget exceeding the said budget as approved by the Bank of the Lao PDR, the Ministry of Finance shall be responsible for the required exceeding budget.

Any revenues as generated by the Office shall be transferred into the Revenue Account of the Bank of the Lao PDR.

The Commission shall have its official stamp for official use.

Section 2**Office of the Securities and Exchange Commission****Article 12. Position and Roles of the SEC Office**

The Securities and Exchange Commission Office, abbreviated as "SECO", acts as a secretariat for the Securities and Exchange Commission in formulating necessary policies, strategic plans, regulations, administration and supervisions over securities and the securities market.

Article 13. Organization Structure

The Office shall comprise of Secretary-General, Deputy Secretary-General, directors of divisions, deputy directors of divisions, heads of sections, heads of working units, and a certain number of professional and administrative staff.

Officials and officers who are appointed and recruited in the Office shall perform their roles and duties in accordance with Regulation on Civil Servant Personnel Management.

Officials and officers of the Office shall have good ethics and professional qualifications at a certain level and shall be highly responsible for performing their assigned roles and duties.

continued on next page

*Box A1.1 continuation***Articles 14. Rights and Duties**

The Office shall have the following rights and duties:

1. To study, interpret and implement strategic plans, policies and decisions approved by the Commission, in regard with development activities on securities and the securities market;
2. To study securities-related rules and regulations, and then propose them to the Commission for consideration and approval;
3. To study and formulate an annual operation plan and budget plan, and propose the plans to the Commission for consideration and approval;
4. To study and improve roles, duties and the organization structure of the Office, to propose the appointment or removal of senior officials and employees equivalent and below any positions of Deputy Secretary-General, and any personnel recruitment in order to propose them to the Commission for consideration and approval;
5. To study and consider application documents for securities public offering, and then to propose them to the Commission for consideration and approval;
6. To manage and supervise securities public offerings in an orderly, transparent, fair and consistent manner and to protect the investors' legitimate rights and benefits.
7. To study and consider an application documents for the establishment of securities business licenses and a securities exchange, and then to propose them to the Commission for consideration;
8. To manage and supervise operations of the issuing companies, securities companies, and the securities market in a stable, transparent, fair and efficient manner;
9. To organize an examination and grant Securities Practitioner Licenses, and to supervise the licensed securities practitioners;
10. To collect, compile and analyze the information data on securities and securities market, and to make a report to the Commission at a regular basis;
11. To disseminate regulations, information and knowledge on securities and the securities market to the public;
12. To study and propose the awards to be granted toward individuals and organizations who have significantly contributed to the development in the areas of securities and securities market;
13. To study and consider in the process of settling disputes and denunciations in activities of securities and the securities market, based upon its stated rights;
14. To implement measures against violators in activities of securities and the securities market, as specified by the Commission;
15. To coordinate with other related agencies in order to promote efficient operations in the field of securities and the securities market;
16. To study and propose the international cooperation plan in the field of securities and the securities market, including exchange of information, to the Commission and carry out the said cooperation plan;
17. To publicize and organize training sessions in the field of securities and securities market for the staff of the Office and securities-related practitioners;
18. To carry out other rights and duties as specified by the Commission.

Part III**Securities Issuance and Public Offering****Section 1****Securities Issuance****Article 15. Criteria for Securities Issuance**

Any companies [sic] established in accordance with Lao Enterprise Law, wishing to issue securities for public offering, shall meet the following criteria:

1. Being established in any kind of company, except for a sole limited company;
2. Having a minimum paid-up charter capital at the time of registering for public offering at least two billion kip in book value;
3. Having sound financial performances; having not accumulated losses; being profit-making in the year preceding the year of such registration for offering; and its financial statement shall be audited by an external certified auditing firm. Additional conditions for offering bonds to the public, the enterprise shall not have overdue debts over than one year up to the year of registration for offering;
4. Other criteria and conditions as stipulated by the Office.

The Commission shall be granted the authority to formulate the regulations concerning overseas issuance and public offerings of any companies located in Lao PDR and any companies wishing to make an public offerings in Lao PDR.

Article 16. Application Documents for Securities Public Offering

The application documents shall include the following documents:

1. An application form of IPO as defined by the Office;
2. A certified copy of the company's business registration certificate;
3. The company's charter; the list and curriculum vitae of principal shareholders and members of the Board of Management;
4. Financial statements of the three most recent consecutive years which are audited by an approved external auditing company;
5. Decisions of the General Shareholder's Meeting or an authorized agency approving the plan for offering and use of capital received from the offering of securities to the public;
6. The commitment of underwriting;
7. The prospectus;
8. Other documents as specified by the Office.

continued on next page

*Box A1.1 continuation***Article 17. The Prospectus**

The prospectus shall include the following information:

1. Brief information on the issuer; including the Company's name, organizational structure, business activities, property, financial situation, the Board of Management or the company's owner, General Director and shareholders' structure;
2. Information on the offering and securities to be offered; including conditions for offering, risk factors, a number of shares and price per share to be offered, the plan of issuance and use of capital received from the offering;
3. The financial statements of the three most recent consecutive years or financial statements from the date of newly establishing a company which shall be audited by an approved external auditing company;
4. The list of an approved external auditing company, a financial advisory company, and a legal consultancy company;
5. Methods of securities subscription and offering;
6. Other information as stipulated by the Officer.

Article 18. Decision on Securities Offering License

The Office shall examine the application documents and notify the applicant of its decision in writing within 45 working days as from the date of receiving the complete and correct application documents.

In case of receiving the valid documents, the Officer shall grant the Certificate of Public Securities Offering to the applicant.

In case of refusal, the Office must respond the applicant in writing and clarify the reasons thereof.

Article 19. Characteristics of Securities

Securities offered to the public shall have the following characteristics:

1. Securities shall be tradable and transferable;
2. Securities shall be denominated in Lao Kip or another currency as stipulated by the Office;
3. The par value of share shall not exceed [KN]100,000 and the par value of bond shall not be less than [KN]1 million.
4. Other characteristics as stipulated by the Office.

Article 20. Securities Depository Book

The securities depository book shall include the following information:

1. Information on the securities holder;
2. The issuer's name and business registration certificate;
3. Type of securities;
4. Amount and par value of the securities;
5. Date of securities offering and a securities code that is registered at the Office;
6. Terms and conditions on dividend or interest payment;
7. Terms and conditions of principal repayment in case of bond securities;
8. Authorized signature and official stamp of the securities companies;
9. Instructions on how to use the Securities Depository Book;
10. Other contents as prescribed by the Office.

Section 2**Securities Public Offering****Article 21. Public Announcement of the Issuance**

The issuer is required to make a public announcement of its offering on the national mass media and directly advertise its offering to a group of minimum 30 investors excluding institutional investors or other forms as stipulated by the Office.

The issuer must submit the report on its offering price to the Office for a sale approval after completing the public announcement of its offering.

Information and contents to be advertised shall be consistent with and the same as contents written in the Prospectus as defined in Article 17 of this Decree.

The issuer shall complete the public announcement of its offering within 60 days from the date of receiving the Certificate of Public Securities Offering.

Article 22. Distribution of Securities

The issuer and the underwriter must conduct a distribution mechanism that allows investors to subscribe securities. In case where the amount of securities subscribed exceeds the amount of securities allowed to issue, the issuer or the underwriter shall have to sell out the securities underwritten to investors proportionately with their purchasing registration.

The issuer shall complete the distribution of securities within 90 days from the date of receiving the Certificate for Public Securities Offering. In case where the issuer cannot complete the distribution of securities to the public within such time limit, the Office shall consider the extension of this period, upon receiving an official request from the issuer, which shall not be more than 30 days.

continued on next page

Box A1.1 continuation

The money for subscription of securities shall be transferred into a blocked bank account until the issue is completed and reported to the Office. The money in such an account shall not be withdrawn without an approval from the Office.

The issuer shall report the offering result to the Office in writing within 10 days from the date of completing the offering of securities.

The underwriter shall issue the Securities Depository Book to the buyers within 30 days from the date of completing the offering and receiving the Certificate for Securities Offering Completion from the Office.

Article 23. Foreign Participation

Foreign investors shall be allowed to invest in securities in compliance with the relevant regulations as stipulated by the Commission.

Article 24. Suspension of the Public Securities Offering

The Office shall have the right to suspend the public securities offering in the following cases:

1. Provision of any inaccurate information or omission of any important contents in the Prospectus that may cause damages to investors;
2. The distribution of securities is not conducted in compliance with Article 21 and 22 of this Decree.

Article 25. Cancellation of the Public Securities Offering

The Office shall have the rights to cancel the offering and prohibit the sale of such securities in the case that an issuer shall not overcome the causes leading to the suspension of the public securities offering as stated in Article 24 of this decree and violate any relevant regulations as stipulated by the Commission.

The issuer must refund the money to the investors and re-collect the distributed securities from the investors within 15 days from the date of the offering cancellation. If the issuer fails to do so within this time limit, the underwriter shall have to pay damages to the investors in accordance with the terms committed with the investor.

Part IV**Securities Companies****Article 26. Establishment of Securities Companies**

A person and organization who is willing to establish a securities company shall submit application documents to the Office.

A securities company shall be established in a limited liability company, except for a sole limited liability company.

Article 27. Criteria for a Securities Business License

A person and organization who is willing to establish a securities company shall meet the following requirements:

1. Having an appropriate office location and adequate technical facilities for securities businesses;
2. Having a minimum legal paid-up charter capital as stipulated by the Commission;
3. Having its directors and practitioners who have qualifications and experience in the field of securities-related businesses, finance-banking, and qualified for being granted the securities practitioner certificate by the Office as specified in Article 42 of this Decree;
4. Having a reasonable business plan;
5. Other requirements as stipulated by the Office.

Article 28. License Application Documents

The application documents for securities business license include:

1. The application form as specified by the Office;
2. The agreement for establishing a securities company;
3. The company's charter;
4. Certificates related to the qualifications, work experience and securities practitioner certificate of proposed administrators, and principal shareholders;
5. The list of shareholders and their proportion of shareholding;
6. A certificate of financial status related to principal shareholders that is audited by an approved external auditing company. In the case of individuals as the shareholders, their bank deposit certificate(s) that are certified by a relevant bank shall be submitted;
7. A business plan for the first 3 business years;
8. Other documents as stipulated by the Office.

An applicant shall pay fees accordingly to regulations as specified by the Office.

Article 29. License Decision

The Office shall consider the application documents and inform the applicant of the result in writing within 60 days as from the date of receiving full and complete application documents for a license.

continued on next page

Box A1.1 continuation

The applicant shall be granted the Establishment and Operation License only if it satisfies all requirements as stated in Article 27 of this decree.

In case of refusal, the Office shall give a written response to the applicant stating the reasons thereof. The unsuccessful applicant shall be able to re-submit the application documents after any causes which make the Office not able to issue a securities business license have been overcome.

After receiving the approval for a license, the applicant shall apply for an enterprise registration certificate and tax registration certificate in compliance with applicable laws and has to undertake business operations within 90 days after receiving the enterprise registration certificate.

Article 30. Scope of License

A securities company shall operate its securities business activities partially or fully, as follows:

1. Brokerage;
2. Dealing on own accounts;
3. Financial and securities investment advisory;
4. Underwriting;
5. Other securities businesses as authorized by the Commission.

Article 31. The Securities Company's Charter

Each securities company shall have a charter that specifies:

1. Its corporate name that shall have a word "securities company" in front and "limited" or "public" at the end;
2. Its corporate address;
3. Its purposes;
4. The amount of its registered capital;
5. The classes and amount of its authorized shares and shareholders' structure;
6. Full names, addresses and nationalities of the company founders;
7. Governance structure;
8. Meeting and voting;
9. Method of dividend distribution;
10. Dispute settlement method; and
11. Method of liquidation.

The company's charter shall have the legal effect only after the securities company has a written approval of the Office.

Article 32. Changes that have to be Approved

A securities company is required to obtain an approval in writing from the Office for the following changes:

1. Decrease of its paid-up charter capital;
2. Changes of address of the head office, branches or representative office;
3. Changes of its corporate name;
4. Changes of principal shareholders' structure;
5. Other changes as stipulated by the Office.

Article 33. Merger of Securities Companies

A merger of securities companies shall be subject to Article 159 and 187 of the Enterprise Law.

A securities company wishing to merge with another securities company shall submit its application documents to the Office. The Office shall consider the application and notify the applicant in writing within a maximum period of 60 days from the date of receiving a full and complete application documents.

The new company established by the merger must proceed with the formalities of application for granting securities business license in accordance with Article 28 of this Decree.

Article 34. Securities Companies Established by Foreign Investors

Foreign investors are allowed to establish a joint venture securities company with domestic investors. The share of capital contributed by foreign investors in a joint venture shall not exceed 51 percent of the total outstanding shares.

Article 35. Granting a Securities Business License for the Branch of Foreign Securities Companies

A foreign securities company wishing to establish its branch in the Lao PDR shall meet the following requirements:

1. Satisfying adequate requirements set out in Clause 1, 3, 4 and 5 of Article 27 of this Decree;
2. Having a minimum legal paid-up charter capital as specified by the SEC;
3. Having sound financial performance;
4. Receiving a permission certificate issued by a concerned supervision authority of its native country at the time of submission.

The applicant shall submit application documents as set out in Article 28 of this Decree and provide the following additional documents:

1. Certified copy of its enterprise registrations;

continued on next page

Box A1.1 continuation

2. Permission certificate issued by a concerned supervision authority of its native country allowing it to establish its branch in Lao PDR;
3. Certified copy of the company's charter and its branch's charter;
4. The list of staff in each position;
5. The agreement or official document certifying the responsibilities and obligations of the parent company over the business operations undertaken by its branch;
6. Other documents as stipulated by the Office.

Article 36. Scope of License Regarding a Branch of a Foreign Securities Company

A branch of a foreign securities company is allowed to undertake the securities businesses:

1. Securities brokerage;
2. Securities dealing on its own account;
3. Other kinds of securities businesses as granted by the Commission.

Article 37. Representative Offices of Foreign Securities Companies

Foreign securities company wishing to establish its representative office in Lao PDR shall submit an application documents to the Ministry of Planning and Investment.

Representative offices are allowed to carry out the following scope of license:

1. Being a coordination office and undertaking a marketing study;
2. Promoting the technical cooperation regarding the development of securities and securities market in the Lao PDR;
3. Other activities as stipulated in applicable laws.

Article 38. Accounts and Financial Statements of Securities Companies

Each securities company shall implement accounting rules and standards as prescribed in the Law on Enterprise Accounting.

Each securities company shall carry out and complete an annual external audit within the first quarter of the following financial year, and submit an audit report to the Office and publish a report of its financial situation to the public within April of each year.

Article 39. Suspension of the Establishment and Operation License of the Securities Company

The Office shall have the right to suspend business operations of the securities companies in the following circumstances:

1. Failing to implement the Law on Enterprise Accounting and a reporting regime as stipulated by the Office;
2. Violating provisions of any concerned regulations regarding securities and securities market;
3. Having evidence that a securities company conducts its business operations in a manner that may cause potential impact on the investors' legitimate rights and benefits;
4. Violating any clauses stipulated in Article 58 of this Decree;
5. Violating applicable laws and regulations of the Lao PDR.

Article 40. Revocation of the Securities Business License

A securities' firm may be revoked from its business license in any of the following cases:

1. Based upon the application request submitted by a securities company in accordance with the resolutions of its shareholders' meeting;
2. The application documents for issuance of or supplement to the securities business license includes any incorrect information that may cause any severe impact on the capital market system and its sound business operations;
3. A securities company may merge with another securities company, leading a loss of its legal entity status;
4. Violating provisions on prudential requirements as stipulated by the Office;
5. Being dissolved or bankrupt.

Upon the revocation of its securities business license, the Office shall be responsible to make a public announcement on a national newspaper and on its electronic communication media for 10 consecutive days.

Article 41. Liquidation upon Revocation of a Securities Business License

A securities company whose securities business license is revoked and terminated as described in Article 40 of this Decree shall implement a method of liquidation in the following cases:

1. If its securities business license is revoked in accordance with the decisions of the shareholders' meeting, a method of liquidation shall be subject to the provisions in Law on Enterprise.
2. If its securities business license is revoked due to its violation of applicable laws and regulations, its financial difficulties and business instability, the Office shall appoint a liquidation committee, comprising of representatives from relevant agencies, in order to implement any necessary liquidation process. The Office shall formulate a regulation regarding liquidation.
3. In case of dissolution and bankruptcy of securities companies by the court's decision, a method of liquidation shall be made in accordance with Law on Bankruptcy of Enterprise.

continued on next page

*Box A1.1 continuation***Article 42. Securities Practitioner Certificate**

Individuals wanting to be a securities practitioner shall be employed by a securities company and receive a Securities Practitioner Certificate. The Office shall grant the Securities Practitioner Certificate to individuals who meet the following requirements:

1. Having adequate legal and civil behavior capacity;
2. Shall not be sentenced by the court of offences related fraud, deception, falsification of document, taking or giving bribe, corruption or money laundering;
3. Holding a university degree or above in the field of finance-banking, business administration, law, accounting or economics;
4. Having passed a securities-related examination organized by the Office.
5. An individual who owns a professional certificate of securities and the securities market from a relevant authority of its native country may obtain the Lao Securities Practitioner Certificate by passing an examination of applicable laws of Lao PDR organized by the Office.

Article 43. Revocation of Securities Practitioner Certificate

A securities practitioner shall be subject to revocation of the Securities Practitioner Certificate in the following cases:

1. The application documents for issuance of or supplement to the securities practitioner certificate includes any incorrect information ;
2. Violating the provisions on securities professional practitioners;
3. Not conducting any securities practice for 3 consecutive years.

Part V**Securities Exchange****Section 1****Establishment****Article 44. Establishment of a Securities Exchange**

A centrally organized securities exchange shall be established in a limited liability company, except for a sole limited liability company, and the establishment shall be decided by the Office.

A person and organization who is wishing to establish a securities exchange shall meet the following requirements:

1. Having an appropriate location and office;
2. Having adequate, modern and secure technical facilities for securities business operations;
3. Having its directors, audit committee and key staff who have qualifications and experience in the field of securities business;
4. Having a reasonable business plan and adequate capital;
5. Other requirements as stipulated by the Office.

Article 45. License Application Documents

The applicant shall submit the application documents for a securities exchange license to the Office.

The application documents include:

1. The application form as specified by the Office;
2. The agreement for establishing a securities exchange;
3. The exchange's charter;
4. Certificates related to the qualifications and experience of proposed administrators and principal shareholders;
5. The list of shareholders and their proportion of shareholding;
6. A certificate of financial status and other necessary documents related to principal shareholders;
7. A business plan for the first 3 business years after the establishment;
8. Other documents as stipulated by the Office.

An applicant shall pay fees according to regulations as specified by the Office.

Article 46. Organizational Structure of a Securities Exchange

The organizational structure of a securities exchange shall include the shareholders' meeting, Board of Directors, Audit Committee, Governance Committee, Securities Depository Center, Payment Supporting Fund, and other divisions.

The appointment of the Chairman of its Board of Directors and its Chief Executive Officer shall be decided and approved by the Commission.

Article 47. The Exchange's Charter

The charter of a securities exchange shall have the contents in consistence with Article 82 as set out in Law on Enterprise.

The charter shall have legal effect only if the securities exchange has a written approval from the Office.

continued on next page

*Box A1.1 continuation***Article 48. Rights of the Securities Exchange**

The securities exchange shall have the following rights:

1. To promulgate the regulations on securities listing, securities trading, information disclosure and trading members upon approval from the Office.
2. To organize, manage and regulate the securities trading activities at the Securities Exchange.
3. To temporarily discontinue, suspend or, cancel securities trading in accordance with its applicable regulations.
4. To approve or cancel the listing of securities and monitor listed companies' implementation of listing requirements on the Securities Exchange;
5. To approve or cancel the membership of the securities companies at the Securities Exchange;
6. To supervise and monitor securities trading activities, to investigate any suspected transactions, and fine trading members at the Securities Exchange. Such said fine shall not exceed KX100 million;
7. To supervise the information disclosure of listed companies and trading members at the Securities Exchange;
8. To provide market information and information relating to listed securities;
9. To act as a conciliator upon request of trading members when any disputes arise relating to securities trading activities;
10. To collect fees in accordance with the regulations upon an approval from the Office;
11. Other rights as approved by the Office.

Article 49. Duties of the Securities Exchange

The securities exchange shall have the following duties:

1. To ensure that securities trading activities in the market are conducted in a public, equal, orderly and efficient manner;
2. To comply with the reporting and auditing regimes in accordance with applicable laws;
3. To publish information relating to securities trading activities taking place in the Securities Exchange, listed securities and trading members;
4. To provide information and coordinate with competent state agencies in the investigation, and prevention and fight against violations of the provisions on securities and the securities market;
5. To carry out dissemination and investor education regarding securities and the securities market;
6. To pay damages to trading members in case of failure to perform duties resulting in damages to trading members, except for force majeure cases;
7. To act as a center in regard with clearing and settlement on behalf of buyers and sellers, including transfer agent for securities among traders;
8. Other duties as approved by the Office.

Article 50. Trading Members

Securities firms licensed according to this Decree shall be eligible to register as trading members of the Securities Exchange upon conditions, procedures and provisions as provided in its regulation on trading members. Trading members shall operate in compliance with applicable regulations of the Securities Exchange.

Article 51. Securities Listing

An issuer shall be eligible to list their securities in the Securities Exchange. The issuer shall have to meet requirements on capital, business operation and financial capability, and the number and structure of shareholders as stipulated by the Securities Exchange. The issuer submitting the application documents for listing shall be responsible for the accuracy, honesty and adequacy of the listing documents in accordance with Regulation on securities listing as specified by the Securities Exchange.

The listed organizations shall operate in compliance with applicable regulations of the Securities Exchange.

Article 52. Securities Trading Activities

The Securities Exchange shall organize listed securities transactions according to the concentrated order-matching method in order to ensure a transparent, fair and efficient market operation.

Securities listed in the Securities Exchange shall be traded only at the securities companies being trading members of the Securities Exchange.

Article 53. Reporting Regime

The Securities Exchange shall have to report its business operation activities including financial performance to the Office, as follows:

1. A quarterly report shall be submitted not later than the 30th of the following month;
2. An audited annual report shall be submitted within 7 days after the completion of an external auditing performance.

Article 54. External Audit

The Securities Exchange shall annually be audited by an independent external auditing company which is in the list of external auditing companies as approved by the Office. An audit report shall be certified in written by an auditing organization and completed within the first quarter of the following financial year.

Section 2**Securities Depository Center****Article 55. Securities Depository Center**

The Securities Depository Center shall be a part of the Securities Exchange and perform the following duties:

continued on next page

Box A1.1 continuation

1. To register and deposit securities;
2. To transfer securities ownership to the holders;
3. To make clearing and settlement relating to securities transactions;
4. To prepare and issue the list of securities holders upon the issuer' request;
5. To provide other services relating to the distribution of dividends and the request of organizing the shareholders' meeting upon the request of public companies and issuers;
6. Other duties as approved by the Office.

Article 56. Payment Supporting Fund

The payment supporting fund shall be a part of the Securities Exchange in order to prevent any potential payment risks regarding cash settlement. Each trading member shall contribute to the fund accordingly to the rate of contribution as stipulated in applicable regulations of the Securities Exchange.

Article 57. Cash Settlement

Each trading member shall appoint any commercial bank as their correspondent bank in order to manage cash accounts and perform the payments of money concerning to securities transactions. The agreement on such said business partnership shall be created and approved by the Office.

The Bank of the Lao PDR shall serve as the designated settlement bank among trading members of the Securities Exchange.

Part VI**Prohibited Acts, Information Disclosure, Report Regime, Inspection and Settlement of Disputes**

Article 58. Prohibited Acts regarding Securities Transactions

Individuals and organizations shall be prohibited from undertaking the following securities-related activities:

1. The issuing company advertises the securities public offering and distribute the securities prior to having obtained an approval from the Office;
2. The securities company performs any operation activities in order to manipulate the actual securities prices, amount and characteristics, which may cause negative damages to the securities market or may take advantage over the investors and its clients; buys or sells any unauthorized securities; and buys or holds securities exceeding a holding proportion limit as stipulated by the Office;
3. Individuals or organizations which are not licensed securities companies undertake any securities businesses without having obtained an authorization from the Office;
4. Securities listed in the Securities Exchange are traded outside the Securities Exchange;
5. Insiders use inside information to buy or sell securities for his own or for a third party; disclose and provide inside information to a third party to buy or sell securities basing on the inside information; and disclose the clients' information negatively or abusing the rights to buy and sell securities on behalf of its clients without their permission;
6. Individuals or organizations who know or possess internal information and use the information for the benefit of their securities-related activities;
7. Individuals or organizations manipulate the security prices which are not consistent with the actual market condition by undertaking securities transactions without transferring the ownership attached to those securities; or conspiring with each other to buy or sell securities to thereby create false supply of and demand for securities; or buying, selling or enticing others to continuously buy or sell securities in order to manipulate the securities prices;
8. Individuals or organizations create and disseminate false information that seriously affects the securities market and investment transactions, prior to receiving an approval from the Office;
9. Legal persons open accounts in the name of individuals to buy or sell securities.
10. Institutions are named "Securities Company" or "Securities Exchange" or "similar words" without an authorization from the Office;
11. Individuals or organizations takes advantage of a securities business license for money-laundering purposes;
12. Individuals or organizations open accounts in the name of another individual or organizations to buy or sell securities;
13. Individuals or organizations perform any obstacles against inspection and auditing activities undertaken by the Office, the Internal Audit Committee and an external auditor, by refusing and delaying to provide information and cooperative supports;
14. An external auditor has direct interests or hold more than 0.1% of total share amount in a public company at the time that it performs an auditing service for the public company;
15. The securities company have direct interests or hold more than 0.1% of total share amount in an issuer at the time that it performs an underwriting service for the issuer;
16. The securities company uses the clients' deposited money or securities or both on behalf of the clients without their permission;
17. Individuals or organizations fail to provide and publish information on securities transactions in a full and timely manner, which may cause damage to investors' interests;
18. Other prohibited acts as stipulated by the Office.

Article 59. Information Disclosure of an Issuing Company

An issuer is required to conduct the disclosure of information via any means of the mass media or via an information communication system of the Office. The publication of information shall include:

1. Quarterly financial statement which is audited by an internal auditor;
2. An annual financial report which is audited by an certified external auditing organization;
3. An annual business report;

continued on next page

*Box A1.1 continuation***4. Other information as stipulated by the Office.**

In addition to the disclosure of information to the Office, listed companies are required to disclose information in accordance with regulations as stipulated by the Securities Exchange.

Article 60. Reporting Regime

The issuers, securities companies and the Securities Exchange are required to report to the Office according to regulations as prescribed by the Office.

Article 61. Inspection

The Office shall inspect the issuers, securities companies and the Securities Exchange on the basis of scheduled inspections and ad hoc inspections whenever necessary.

The issuers, securities companies and the Securities Exchange shall facilitate and provide information to the Office at the time of performing its inspection activities.

Article 62. Rights and duties of Inspectors of the Office

Inspectors of the Office shall have the following rights and duties:

1. To inspect the implementation of rules and regulations regarding securities and securities market in order to ensure a stable, transparent, fair and efficient market;
2. To examine the accounts, books, documents, electronic data, and other records concerning securities-related transactions;
3. To require administrators and employees to provide all information on any matter relating their administration and operations;
4. To enter any premises where a violation of applicable law and regulations is suspected to have been committed and seize documents or other property connected with the suspected commission of the violation;
5. To meet with the board of directors and administrators of the said organizations in order to make assessment on the implementation of this Decree and other relevant regulations related to securities and securities market;
6. To implement any measures and sanctions against violators of applicable regulations related to securities and securities market;
7. To exercise other rights and perform other duties as stipulated by the Office.

Article 63. External Auditor

Each issuer, securities company and Securities Exchange shall be audited by an independent external auditing organization. Such an auditing organization shall be certified and authorized by the Office.

An audit on the issuer, securities company and Securities Exchange shall be performed and completed within the first quarter of the following financial year and an audit report shall be published to the public.

Article 64. Settlement of Disputes

If any dispute arises from operations in securities and securities market, such dispute shall be settled amicably between the Parties hereto by mutual discussions. In case no settlement can be reached by consultation, the parties may submit the case of such an arising dispute to the Office for mediation.

In case reconciliation fails, the parties may bring the dispute to an arbitrator or to the court for settlement in accordance with applicable laws.

Regarding the request to the Office to act as a mediator to settle the arising dispute, the parties shall bear the costs of the arbitration as stipulated by the Office.

Part VII**Awards and Sanctions****Article 65. Awards to Persons Who Have Performed Well**

Any person or organization who has outstanding performance in operation, development and management activities in the field of securities and securities market, and prevent infringement of this Decree and relevant regulations regarding securities and securities market will be rewarded and receive other policy by applicable regulations.

Article 66. Sanctions against Violators

Any person or organization who violates the provisions in this Decree shall be subject to the following sanctions and penalties; namely, being warned in writing, being fined, suspending or revoking a securities business license, revoking the Securities Practitioner License, and being subject to legal proceedings [based on] the character and scope of their violation.

continued on next page

Box A1.1 continuation

Part VIII

Final Provisions

Article 67. Implementation

The Commission and Office shall implement this Decree.

Ministries, ministerial equivalents, and the related sectors of the economy shall disseminate and strictly implement this decree.

Article 68. Effectiveness

This decree shall enter into force after 30 days as from the date of signature.

Any regulation, provisions that conflict with this decree shall be repealed.

FOR AND ON BEHALF OF THE GOVERNMENT

PRIME MINISTER

(Signature and seal)

Bouasone Bouphavanh

Appendix 2: Part II. Disclosure by Bond-Listed Corporation

Box A1.2 Part II. Disclosure by Bond-Listed Corporation

Disclosure Regulation of Lao Stock Exchange, January 2011:

Article 27. Objectives

The purpose of this Part is to stipulate the matters necessary for reporting and disclosing the business details of the companies that have listed the corporate bonds on the LSX.

Article 28. Definitions

- (1) The term “a bond-listed corporation” shall mean the issuer of the bonds listed in the LSX.
- (2) The term “a listed bond” shall mean a bond issued pursuant to the Law and listed on the LSX.

Article 29. Material Business Details to be Reported

(1) In case where a bond-listed corporation, which has also listed a stock on the LSX, has disclosed the matter specified in [Article 7] in relation to the stocks, it shall be deemed that such a bond-listed corporation has made a disclosure in accordance with this Part. [sic]

(2) When coming under any of the following items, a bond-listed corporation shall report such fact or details of decision made to the LSX on the same day the incidence [sic] has occurred:

1. Cases where the bill or check issued was dishonored or the transaction with the bank has been suspended or prohibited;
2. Cases where the business operation, in part or whole, has been suspended;
3. Cases where the causes for dissolution has occurred;
4. Cases where the decision on merger with another company, business transfer or acquisition, split-off, merger after split-off has been made;
5. Cases where a lawsuit that will have material influence on the listed bonds has been launched;
6. Cases where the auditor’s opinion in [sic] the external certified audit report is qualified, adverse or disclaimer of opinion.

(3) When coming under any of the following items, the bond-listed corporation shall report such facts or details of decision made to the LSX by the next day of occurrence of the causes:

1. Case where the bond has been redeemed before its maturity;
2. Case where the notification of calling of a meeting of bondholders has been sent;
3. Case where the decisions made at the meeting of bondholders has been notified;
4. Case where the principal of listed bond has not been paid; and
5. In addition, case where significant events relating to the rights, yields or handling of listed bond have occurred.

Article 30. Unfaithful Disclosure

(1) When a bond-listed corporation does not report the matters to be disclosed pursuant to [Article 29] or submits the report after the reporting deadline, or reverses or changes the details already reported, such cases shall deem to be an unfaithful disclosure. However, this provision shall not be applied to the case where a bond-listed corporation, which has listed a stock, comes under the unfaithful disclosure by breaching [Article 7].

(2) In case where a bond-listed corporation comes under the unfaithful disclosure, the LSX shall release such fact through its disclosure media, etc.

Article 31. Mutatis Mutandis Application

The provisions of [Article 2(3), Article 4, Article 5, Article 6, Article 24, Article 25 and Article 26] shall apply to a bond-listed corporation.

Appendix 3: Law on the Promotion and Management of Foreign Investment in the Lao People's Democratic Republic

Box A1.3 Law on the Promotion and Management of Foreign Investment in the Lao People's Democratic Republic

LAW ON THE PROMOTION AND MANAGEMENT OF FOREIGN INVESTMENT IN THE LAO PEOPLE'S DEMOCRATIC REPUBLIC

Article 1:

The Government of the Lao People's Democratic Republic encourages foreign persons, either individuals or legal entities, to invest capital in the Lao People's Democratic Republic (hereinafter "the Lao PDR") on the basis of mutual benefit and observance of the laws and regulations of the Lao PDR. Such persons hereinafter shall be referred to as "foreign investors."

Article 2:

Foreign investors may invest in and operate enterprises in all fields of lawful economic activity such as agriculture and forestry, manufacturing, energy, mineral extraction, handicrafts, communications and transport, construction, tourism, trade, services and others.

Foreign investors may not invest in or operate enterprises which are detrimental to national security, the natural environment, public health, the natural culture, or which violate the laws and regulations of the Lao PDR.

Article 3:

The property and investment in the Lao PDR of foreign investors shall be fully protected by the laws and regulations of the Lao PDR. Such property and investments may not be requisitioned, confiscated or nationalized except for a public use purpose [sic] and upon payment of prompt, adequate and effective compensation.

SECTION II: FORMS OF FOREIGN INVESTMENT

Article 4:

Foreign investors may invest in the Lao PDR in either of the following forms:

- (1) A Joint Venture with one or more domestic Lao investors; or
- (2) A Wholly Foreign-Owned Enterprise.

Article 5:

A Joint Venture is a foreign investment established and registered under the laws and regulations of the Lao PDR, which is jointly owned and operated by one or more foreign investors and by one or more domestic Lao investors. The organization, management and activities of the Joint Venture and the relationship between its parties shall be governed by the contract between its parties and the Joint Venture's Articles of Association, in accordance with the laws and regulations of the Lao PDR.

Article 6:

Foreign investors who invest in a Joint Venture must contribute a minimum portion of thirty percent (30%) of the total equity investment in that venture. The contribution of the venture's foreign party or parties shall be converted in accordance with the laws and regulations of the Lao PDR into Lao currency at the exchange rate then prevailing on the date of the equity payment(s), as quoted by the Bank of the Lao PDR.

Article 7:

A wholly Foreign-Owned Enterprise is a foreign investment registered under the laws and regulations of the Lao PDR by one or more foreign investors without the participation of domestic Lao investors. The enterprise established in the LAO PDR may be either a new company or a branch or representative office of a foreign company.

Article 8:

A foreign investment which is a Lao branch or representative office of a foreign company shall have Articles of Association which shall be consistent with the laws and regulations of the Lao PDR and subject to the approval of the Foreign Investment Management Committee of the Lao PDR.

Article 9:

The incorporation and registration of a foreign investment shall be in conformity with the Enterprise Decree of the Lao PDR.

continued on next page

Box A1.3 continuation

SECTION THREE: BENEFITS, RIGHTS AND OBLIGATIONS OF FOREIGN INVESTORS

Article 10:

The Government of the Lao PDR shall protect foreign investments and the property of foreign investors in accordance with the laws and regulations of the Lao PDR. Foreign investors may lease land within the Lao PDR and transfer their leasehold interests; and they may own improvements on land and other moveable property and transfer those ownership interests. Foreign investors shall be free to operate their enterprises within the limits of the laws and regulations of the Lao PDR. The Government shall not interfere in the business management of those enterprises.

Article 11:

Foreign investors shall give priority to Lao citizens in recruiting and hiring their employees. However, such enterprises have the right to employ skilled and expert foreign personnel when necessary and with the approval of the competent authority of the Government of the Lao PDR. Foreign investors have an obligation to upgrade the skills of their Lao employees, through such techniques as training within the Lao PDR or abroad.

Article 12:

The Government of the Lao PDR shall facilitate the entry into, travel within, stay within, and exit from Lao territory of foreign investors, their foreign personnel, and the immediate family members of those investors and those personnel. All such persons are subject to and must obey the laws and regulations of the Lao PDR while they are on Lao territory. Foreign investors and their foreign personnel working within the Lao PDR shall pay to the government of Lao PDR personal income tax at a flat rate of ten percent (10%) of their income earned in the Lao PDR.

Article 13:

Foreign investors shall open accounts both in Lao currency and in foreign convertible currency with a Lao bank or foreign bank established in the Lao PDR.

Article 14:

In the management of their enterprises, foreign investors shall utilize the national system of financial accounting of the Lao PDR. Their accounts shall be subject to periodic audit by the Government's financial authorities in conformity with the applicable Lao accounting regulations.

Article 15:

In conformity with the law and regulations governing the management of foreign exchange and precious metals, foreign investors may repatriate earnings and capital from their foreign investments to their own home countries or to third countries through a Lao bank or foreign bank established in the Lao PDR at the exchange rate prevailing on the date of repatriation as quoted by the Bank of the Lao PDR. Foreign personnel of foreign investments may also repatriate their earnings, after payment of Lao personal income taxes and all other taxes due.

Article 16:

Foreign investments subject to this law shall pay a Lao PDR annual profit tax at a uniform flat rate of twenty percent (20%), calculated in accordance with the provisions of the applicable laws and regulations of the Lao PDR. Other Lao taxes, duties and fees shall be payable in accordance with the applicable laws and regulations of the Lao PDR. For foreign investments involving natural resources exploitation and energy generation, sector-specific taxes and royalties shall be prescribed in project agreements entered into between the investors and the Lao Government.

Article 17:

Foreign investments shall pay a Lao PDR import duty on equipment, means of production, spare parts and other materials used in the operation of their investment projects or in their productive enterprises at a uniform flat rate of one percent (1%) of their imported value. Raw materials and intermediate components imported for the purpose of processing and then re-exported shall be exempt from such import duties. All exported finished products shall also be exempted from export duties. Raw materials and intermediate components imported for the purpose of achieving import substitution shall be eligible for special duty reductions in accordance with the Government's applicable incentive policies.

Article 18:

In highly exceptional cases and by specific decision of the Government of the Lao PDR, foreign investors may be granted special privileges and benefits which may possibly include a reduction in or exemption from the profit-tax rate prescribed by Article 16 and/or a reduction in or exemption from the import-duty rate prescribed by Article 17, because of the large size of their investments and the significant positive impact which those investments are expected to have upon the socio-economic development of the Lao PDR. In the event of the establishment of one or more Free Zones or Investment Promotion Zones, the Government shall issue area-specific or general regulations or resolutions.

Article 19:

After payment of its annual profit tax, a foreign investor shall devote a portion of its profit each year to various reserve funds necessary for the operation and development of the enterprise in order to continuously improve the enterprise's efficiency, in accordance with the policies and the Articles of Association of the enterprise.

Article 20:

Foreign investments approved under this law shall at all times be operated in accordance with the laws and regulations of the Lao PDR. In particular, foreign investors shall take all measures necessary and appropriate to ensure that their investments' facilities, factories and activities protect the natural environment and the health and safety of the workers and the public at large, and that their investments contribute to the social insurance and welfare programs for their workers in conformity with the policy and the laws and regulations of the Lao PDR.

continued on next page

Box A1.3 continuation

Article 21:

In the event of disputes between foreign parties within a foreign investment, or between foreign investors and Lao parties, the disputants should first seek to settle their differences through consultation or mediation. In the event that they fail to resolve the matter, they shall then submit their dispute to the economic arbitration authority of the Lao PDR or to any other mechanism for dispute resolution of the Lao PDR, a foreign country or an appropriate international organization which the disputants can agree upon.

SECTION FOUR: THE ORGANIZATION OF FOREIGN INVESTMENT MANAGEMENT

Article 22:

The Government of the Lao PDR has established a State organization to promote and to manage foreign investment within the Lao PDR titled the Foreign Investment Management Committee (hereinafter called “the DDFI”). [NOTE: The DDFI now conducts business under the name DDFI]. The DDFI is responsible for administration of this law and for the protection and promotion of foreign investment within the Lao PDR.

Article 23:

All foreign investments established within the Lao PDR shall be assisted, licensed and monitored through the “one-stop-service” of the DDFI, acting as the central focal point for all Government interactions with the investors, with the collaboration of the concerned ministries and the relevant provincial authorities.

Article 24:

A foreign investment shall be considered to be legally established within the Lao PDR only upon the investor’s receipt of a written foreign investment license granted by the DDFI.

Article 25:

A foreign investor which seeks a license for a foreign investment shall submit to the DDFI an application and such supporting documentation as the DDFI may prescribe by regulation. The DDFI may grant preliminary approval-in-principle for investment projects being specially promoted by the Government.

Article 26:

Upon receipt of a completed application and supporting documentation, the DDFI shall screen them, make a foreign-investment licensing decision, and notify the applicant of that decision within 60 days of the application’s submission date. Within this same overall 60-day period, concerned ministries and provincial authorities consulted by the DDFI for their views shall have a maximum of 20 days in which to reply.

Article 27:

Within 90 days of receiving its foreign investment license from the DDFI, a foreign investor shall register that license and commence operation of its investment in conformity with the implementation schedule contained in the investment’s feasibility study and with the terms and conditions of the license granted by the DDFI, and in accordance with the laws and regulations of the Lao PDR.

Article 28:

The DDFI has responsibility to coordinate with other concerned ministries and provincial authorities in monitoring and enforcing the implementation of a foreign investment in conformity with the investment’s feasibility study and with the terms and conditions of the investment license, and in accordance with the laws and regulations of the Lao PDR. The concerned ministries and provincial authorities have the responsibility to perform their respective monitoring and enforcement obligations.

Article 29:

If a foreign investor violates the agreement and the terms and conditions of its foreign investment license, or the laws and regulations of the Lao PDR, the investor shall be notified of the detected violation and shall be instructed to promptly desist. In the event the investor fails to desist, or in case of a serious violation, the investor’s foreign investment license may be suspended or revoked, and the investor may additionally be subject to other sanctions under the applicable laws and regulations of the Lao PDR.

SECTION FIVE: FINAL PROVISIONS

Article 30:

This law shall come into force 60 days after its ratification. Upon the entry into force of the present law, the foreign investment law of the Lao People’s Democratic Republic No. 07/PSA dated 19 April 1988 shall cease to have effect, without prejudice to the rights and privileges granted to, and the obligations imposed upon, foreign investments under the law No. 07/PSA. Notwithstanding this provision, a foreign investor which received its license under the prior law may elect to petition the DDFI in writing, within 120 days of the coming into force of this law, to become subject to the terms of this law. The DDFI may grant such petitions at its discretion. For a foreign investor whose petition is granted, the rights and benefits previously granted and the obligations previously imposed under the law No. 07/PSA shall thereafter prospectively cease to have effect.

Article 31: The Government of the Lao PDR shall, by decree, issue detailed regulations for the implementation of this law.

Vientiane, 14 March 1994

President of the National Assembly

Signed : Saman Viyaket

Appendix 4: Law on the Promotion of Foreign Investment No. 11/NA (2004)

Box A1.4 Law on the Promotion of Foreign Investment No. 11/NA (2004)

National Assembly

No. 11/NA

Vientiane Capital City, Date: 22 October 2004

Law on the Promotion of Foreign Investment

No. 11/NA

Article 1: Objectives

The Law on the Promotion of Foreign Investment determines principles, regulations and measures regarding the promotion, protection and management of foreign investment in the Lao PDR aiming at enhancing relationships, economic cooperation with foreign countries, and utilisation of financial resources and knowledge to enhance production capacity for purpose of industrialisation and progressive modernisation, as well as to contribute to gradually improving the people's living conditions, and to strengthen and to develop the country.

Article 2: Definitions

“Foreign investment” means the importation of capital which includes assets, technology and expertise into the Lao PDR by foreign investors for business purposes.

“Foreign investor” means a foreign individual or juristic entity investing in the Lao PDR.

“Domestic investor” means Lao individuals or juristic entities, or aliens or stateless persons residing in the Lao PDR who are shareholders or take part in joint ventures with foreign parties.

“Asset” means currency, materials and intellectual property.

“Foreign enterprise” means a 100% foreign-owned enterprise, a joint venture and an enterprise established under a business cooperation contract incorporated in the Lao PDR.

Article 3: Promotion of Foreign Investment

Foreign investors may invest in all business sectors in the Lao PDR, except in business activities which are detrimental to national security or cause a negative impact on the environment in the present or long term, or are detrimental to health or national traditions.

The State promotes foreign investors investing in business sectors and areas of investment as provided in Article 16 and 17 of this law by establishing policies on customs, taxes, regulations, measures and provision of information, services and other facilities to foreign investors.

Article 4: Protection of Foreign Investment

Assets and investment of foreign investors in the Lao PDR shall be fully protected by laws and regulations of the Lao PDR without seizure, confiscation or nationalisation, except if necessary for public purpose, in which case the foreign investors shall be compensated in accordance with laws and regulations.

Chapter II

Forms of Foreign Investment

Article 5: Forms of Foreign Investment

Foreign investors may invest in the Lao PDR in the following forms:

1. Business Cooperation by contract;
2. Joint Venture between foreign and domestic investors;
3. 100% foreign-owned enterprise

Article 6: Business Cooperation by Contract

A Business Cooperation by contract is business between domestic and foreign juristic entities without establishing a new juristic entity in the Lao PDR.

The objectives, forms, business terms, rights and obligations, liabilities and benefits of each party shall be determined by contract.

continued on next page

Box A1.4 continuation

Article 7: Joint Ventures

A Joint Venture is an enterprise established and registered under the laws of the Lao PDR, operated and jointly owned by foreign and domestic investors. The organisation, management, operation and the relationship between the shareholders of the Joint Venture are set out in an agreement made by both parties and in the Articles of Association of such Joint Venture.

Foreign investors investing in a Joint Venture shall contribute at least thirty percent (30%) of the Joint Venture's registered capital. Capital contributed in foreign currency shall be converted into Kip based on the exchange rate of the Bank of the Lao PDR on the day of the capital contribution.

Article 8: 100% Foreign-Owned Enterprise

A one hundred percent (100%) foreign-owned enterprise is an enterprise in which the investment in the Lao PDR is made by a foreign investor only. Such enterprise may be incorporated as a new juristic entity or as a branch of a foreign enterprise.

Article 9: Registered Capital

The registered capital of a foreign enterprise shall not be less than thirty percent (30%) of its total capital. During the business operation of a foreign enterprise, the assets of the enterprise shall not be less than its registered capital.

Article 10: Representative Offices

A foreign juristic entity incorporated under the law of other countries may establish a representative office in the Lao PDR to collect information, study the feasibility of investment, and coordinate for the purpose of applying for investment.

Representative offices or agents which operate for commercial purposes do not come under this Law.

Article 11: Investment Term

The investment term of a foreign enterprise depends on the nature, size and conditions of the business activities or project but will not exceed fifty (50) years and may be extended with the approval of the Government. However, the investment term of a foreign enterprise shall be for a maximum of seventy five (75) years.

Chapter III Rights, Benefits and Obligations of Foreign Investors

Article 12: Rights and Benefits of Foreign Investors

Foreign investors shall have the following rights and benefits:

1. To receive support from the Government in establishing and operating their business in accordance with the laws and regulations;
2. To obtain protection of rights and legitimate interests related to business operations;
3. To own assets;
4. To receive benefits from the lease of or a concession over land such as the right to use, sell or use assets associated with the leased land or concession as security to any persons or financial institutions or for the purpose of joint venture, to sublease the right to use land, to transfer the land lease or concession agreement in accordance with the lease term, to use the land lease agreement or concession in Joint Ventures or as security with other persons. The details of the rights, benefits and obligations of foreign investors related to the land lease or concession shall be in compliance with the Land Law and other relevant laws;
5. To use foreign labourers, if necessary, but shall not exceed 10% (ten percent) of the enterprise's labour;
6. Foreign investors and their families, foreign professionals and employees of a foreign enterprise will be provided with facilities such as multiple-entry visas and long-term residence in the Lao PDR with the agreement of the Government; and will have the right to request Lao nationality in accordance with the Nationality Law;
7. To receive protection of their intellectual property which has been registered by the relevant authorities in the Lao PDR;
8. To transfer/repatriate profits, capital and other income after full payment of duties, taxes and other fees in accordance with regulations and laws, to their home countries or a third country through a commercial bank located in the Lao PDR;
9. To open a Kip account and a foreign currency account with commercial banks located in the Lao PDR;
10. To request an equitable decision from or to file a complaint to the relevant authorities when their business operations have been affected;
11. To obtain other rights and benefits as provided in the Laws.

Article 13: Obligations of the Foreign Investors

The obligations of foreign investors are:

1. To operate business activities in accordance with their licence, procedures set out in their feasibility study, any contract and laws and regulations;
2. To maintain accounts in accordance with the Enterprise Accounting Law of the Lao PDR. If necessary, an internationally recognised accounting system may be used with approval of the Ministry of Finance. To submit a report on business performance and an annual financial report to the Committee for

continued on next page

Box A1.4 continuation

Promotion and Management of Investment and other relevant authorities;

3. To fully pay duties, taxes and other financial obligations related to the business operations in a timely manner;

4. To facilitate the organisation and activities of the mass organisations in their enterprises;

5. To give priority in recruiting to Lao workers, to train and upgrade professional skills and transfer technology to Lao workers;

6. To address social security matters, health care and safety of employees in their enterprises;

7. To protect the environment, and ensure that business activities do not cause an adverse impact on the public, national security or social order;

8. To maintain a reserve in accordance with laws and regulations;

9. To maintain insurance and social security policies in accordance with laws and regulations related to insurance and social security;

10. If an enterprise is relocated, the enterprise shall inform the relevant authorities and shall maintain its location in normal working condition;

11. To report on the performance of business operations to the Committee for Promotion and Management of Investment and other relevant authorities;

12. To perform other obligations as set out in the laws and regulations.

Article 14: Personal Income Tax of Foreign Employees

Foreign employees working in a foreign investment enterprise shall pay personal income tax at the rate of ten percent (10%) of their total income to the Lao Government, except employees of a country with which the Lao Government has signed a Double Taxation Agreement.

Chapter IV Incentives for Foreign Investment

Article 15: Incentives for Foreign Investment

The State will consider granting incentives for foreign investment in accordance with the sectors and zones of investment promotion as provided in Article 16 and 17 of this Law.

Article 16: Promoted Activities

The Government determines promoted activities as follows:

1. Production for export;
2. Agricultural and forestry activities, agro-forestry and handicraft processing activities;
3. Activities relating to industrial processing, industrial activities using modern technology, scientific study and analysis activities and development, activities in relation to protection of the environment and biodiversity;
4. Human resources development, skills development and protection of people's health;
5. Construction of infrastructure;
6. Production of raw materials and equipment to be supplied to key industrial activities;
7. Development of tourism and transit services.

Article 17: Promoted Zones

The Government specifies three promoted zones based on geographical location and socio-economic conditions. The zones are as follows:

Zone 1: Mountainous, plain and plateau zones with no economic infrastructure to facilitate investments.

Zone 2: Mountainous, plain and plateau zones with a certain level of economic infrastructure suitable to accommodate investments to some extent.

Zone 3: Mountainous, plain and plateau zones with good infrastructure to support investments.

The details of the promoted zones will be determined by the Government.

Article 18: Incentives Related to Duties and Taxes

Foreign enterprises investing in activities within the promoted sectors and zones determined in Article 16 and 17 of this Law will be entitled to the following duty and tax incentives:

Investments in Zone 1 will be entitled to a profit tax exemption for 7 years and thereafter will be subject to profit tax at the rate of ten percent (10%).

Investments in Zone 2 will be entitled to a profit tax exemption for 5 years, and thereafter will be subject to a reduced profit tax rate of half of fifteen percent (15%) for 3 years, and thereafter a profit tax rate of fifteen percent (15%).

Investments in Zone 3 will be entitled to a profit tax exemption for 2 years and thereafter will be subject to a reduced profit tax rate of half of twenty percent for 2 years and thereafter a profit tax rate of twenty percent (20%).

Profit tax exemption starts from the date of the foreign enterprise's commencement of business operations. For some tree plantation activities, profit tax exemption commences from the date the enterprise starts making a profit.

Once the profit tax exemption period is over, the foreign investment enterprise shall pay profit tax in accordance with the laws and regulations.

continued on next page

Box A1.4 continuation

In addition to the incentives mentioned above, the foreign investment enterprises shall be entitled to the following incentives:

1. During the tax exemption period and during the tax reduction period, the enterprise is entitled to an exemption of minimum tax;
2. The profit used for the expansion of licensed business activities will be exempted from profit tax during the accounting year;
3. Exemption of import duties and taxes on equipment, spare parts, vehicles directly used for production, raw materials which do not exist domestically or exist but are insufficient, semi-finished products imported for manufacturing or for processing for the purpose of export; and
4. Exemption of export duty on export products.

Raw materials and semi-finished products imported for manufacturing or assembly for import substitution will be exempted from import duties and taxes or will be subject to reduced rates of import duties and taxes.

Special economic zones, industrial zones, border trade areas, and other specific economic zones shall follow the laws and regulations of such specific areas.

Chapter V

Application for a Foreign Investment License

Article 19: Application for Foreign Investment

Application for foreign investment in the Lao PDR shall go through the one-stop service of the Committee for Promotion and Management of Investment (“CPMI”).

Foreign investors wishing to invest in the Lao PDR shall submit an application to CPMI at the central or provincial levels with attachments such as copies of passport and resumé of the foreign investor; feasibility study or business plan; background information on the investor in the case of a juristic entity; and a Joint Venture Agreement in the case of a Joint Venture.

Article 20: Examination of a Foreign Investment Application

Upon receipt of a complete application in accordance with Article 19 of this Law, the CPMI shall coordinate with relevant sectors and local authorities when necessary to examine and to respond in writing to the foreign investor pursuant to the following timeframes:

- Projects which fall in the list of promoted activities – fifteen working days;
- Projects which fall in the list of open activities with conditions – twenty-five working days;
- Projects which involve the grant of a concession – forty-five working days.

Foreign investors who are qualified under this Law will obtain a foreign investment licence, an enterprise registration certificate, and a tax registration certificate at the same time from the CPMI at the place where the foreign investors are licensed; thereafter they will be considered as enterprises established in conformity with the laws of the Lao PDR.

Within 90 days from the date of receipt of an investment licence, the foreign enterprise shall commence investment activities in accordance with the steps in the feasibility study provided in the foreign investment licence application and in conformity with laws and regulations of the Lao PDR. If such timeframe is not followed, the foreign investment licence may be withdrawn.

Chapter VI

Management of Foreign Investment

Article 21: Management Authorities Related to Foreign Investment

Management authorities related to foreign investment are:

1. The Committee for Promotion and Management of Investment at central and provincial levels;
2. Relevant sectors and sections.

Article 22: Rights and Duties of CPMI at the Central Level

The Committee for Promotion and Management of Investment at the central level is established by the Prime Minister, located at the Committee for Planning and Investment and has the following rights and duties:

1. To develop strategies, incentives to promote and attract foreign investments, and propose them to the Government for approval;
2. To issue decisions, orders, instructions, and notifications regarding the protection and promotion of foreign investments;
3. To prepare a plan and a list of investment projects that are available for foreign investments;
4. To disseminate policies, laws and regulations; provide information and facilitate foreign investors;
5. To consider issuing or withdrawing a foreign investment licence within its scope of rights and duties, particularly within projects involving the grant of a concession;
6. To supervise and coordinate with the sectors and local authorities in implementing the Law on the Promotion of Foreign Investment;

continued on next page

Box A1.4 continuation

7. To monitor, inspect, assess, and report to the Government on the business operation of foreign investment enterprises;
8. To be a focal point in supporting, promoting and solving problems occurring in relation to the business operation of foreign investment enterprises;
9. To organise the annual meeting of CPMI and consultative meetings with foreign investors; and
10. To exercise and perform other rights and duties as prescribed in the laws and regulations.

Article 23: Rights and Duties of CPMI at Provincial Levels

The Committee for Promotion and Management of Foreign Investment at provincial levels is established by the Chairman of the CPMI at the central level. The CPMI at the provincial level acts as a support to the provincial governors, the capital city governor, the Special Zone head, and the CPMI at the central level in promoting and managing foreign investment. The CPMI at the provincial level located at the Provincial Planning and Investment Divisions and has the following rights and duties:

1. To implement strategic plans and policies to promote and attract foreign investments at their local levels;
2. To disseminate policies, laws and regulations, provide information and facilitate foreign investors;
3. To consider issuing or withdrawing foreign investment licences within their scope of rights and duties;
4. To coordinate with various relevant sectors in implementing the incentive policies within the approved projects and in implementing the decisions, orders, instructions and notifications of the higher level authorities;
5. To monitor, inspect, assess, and report to the provincial governors, the capital city governor or the Special Zone head, and CPMI at the central level regarding foreign investment;
6. To act as a focal point in solving problems related to foreign investment;
7. To organise the CPMI annual meetings at provincial levels and consultative meetings with foreign investors;
8. To exercise and perform other rights and duties as prescribed in the laws and regulations.

Article 24: Rights and Duties of Other Relevant Sectors and Sections

The relevant ministries, organisations equivalent to ministries, and other relevant sectors shall assist in the promotion and management of foreign investments in accordance with their rights and duties as follows:

1. To coordinate with the CPMI at the central level in drafting laws, regulations, policies and plans in relation to foreign investment;
2. To prepare a plan and list of foreign investment projects to attract foreign investment to their sectors, to disseminate information to attract and promote investment;
3. To participate in the process of consideration and approval of investment projects;
4. To supervise the sectors both at central and local levels in implementing incentive policies and in revising procedures regarding implementation of investment projects;
5. To inspect and assess business operations of foreign investment enterprises and partners' business cooperation contracts within their scope of rights and duties, and then report to the higher authorities;
6. To exercise and perform other rights and duties as prescribed in the laws and regulations.

The administrative authorities and sectors at the local level described above shall coordinate with the CPMI at the local level within the scope of rights and duties described in this Article.

Chapter VII

Dispute Resolution

Article 25: General Principles

If a dispute arises in relation to business operation, the parties shall mediate, arbitrate, or file a petition to the court.

Article 26: Mediation of Disputes

Disputes related to business operation which cannot be mediated by the parties amicably shall be submitted for mediation to the CPMI that has issued the licence.

If the CPMI is not able to mediate such dispute, such dispute shall be submitted to the Economic Dispute Resolution Committee for arbitration.

Article 27: Filing of a Case

The parties to a dispute related to business operation which cannot be mediated may bring the case to the Committee for Economic Dispute Resolution or the People's Court for consideration in accordance with court procedures.

continued on next page

Box A1.4 continuation

Chapter VIII

Policies Toward Those Who Have Performed Well and Measures Against Violators

Article 28: Policies Toward Those Who Have Performed Well

Individuals or organisations who have had outstanding achievements in implementing this law and in contributing to national socio-economic development will receive awards as deemed reasonable.

Article 29: Measures Against Investors Who Violate the Law

Individuals or juristic entities who violate this Law shall be subject to penalties based on the seriousness of the violation in the form of warnings, suspension, withdrawal of their foreign investment licence, or being sued in a court of law.

Article 30: Measures Against Other Violators

Individuals who violate investment laws and regulations by abusing their power or position to hinder or obstruct the promotion and approval of investment, falsify documents, mislead investors, receive bribes, or commit any acts causing damage to the State or investors shall compensate for such damages, and shall be subject to disciplinary and other measures in accordance with the laws of the Lao PDR.

Chapter VIII

Final Provisions

Article 31: Implementation

The Government of the Lao People's Democratic Republic shall implement this Law.

Article 32: Effectiveness

This law will become effective sixty days from the date of the issue of a Promulgating Decree of the President of Lao People's Democratic Republic.

Thereafter, the Law on the Promotion and Management of Foreign Investment No. 01/94/NA, dated 14 March 1994 shall cease to have effect, without prejudice to the rights and privileges granted to, and the obligations imposed upon, foreign investments under the Law No. 01/94/NA.

Foreign investors who have been licensed under the Law No. 01/94/NA and wish to obtain incentives provided by this amended Law on Promotion of Foreign Investment shall submit an official written request within 120 days from the date this law become effective to the Committee for Planning and Investment for consideration.

The Chairman of the National Assembly

Appendix 5: Presidential Decree Law No. 01/P, 17 March 2008 on Governing the Management of Foreign Exchange and Precious Metals

Box A1.5 Presidential Decree Law No. 01/P, 17 March 2008 on Governing the Management of Foreign Exchange and Precious Metals

Presidential Decree Law No. 01/P, 17 March 2008 Governing the Management of Foreign Exchange and Precious Metals

- In reference to the Constitution of the Lao People's Democratic Republic, No. 25/LNA, date 6 May 2003;
- In reference to the Law on the Government of the Lao People's Democratic Republic, No.02/LNA, date 6 May 2003;
- In reference to the Law on the Bank of the Lao People's Democratic Republic, No. 05/LNA, dated 14 October 1999.

The President Of the Lao People's Democratic Republic issues the Decree Law:

Section I General Provisions

Article 1. Purposes

This Decree Law is issued to determine the regulations and principles governing foreign exchange and precious metals. It aims to maintain the stability of the exchange rate between the local currency, the Kip, and the foreign currencies: to promote the circulation of merchandise-money within the country, to protect the independence of the national currency and to stabilize its value, to broaden the external economic relation and cooperation that aim to contribute to the national socio-economic development of the Lao PDR.

Article 2. Definitions

Terms used in this Decree Law are defined as follows:

- "Currency" means the Lao national currency whose unit of value is Kip;
- "Foreign exchange" means the bank notes, the traveler's checks, other commercial papers expressed in foreign currencies and precious metals, which are acceptable for international settlements;
- "Exchange rate" means price of currency in Kip required to buy or sell one unit of the foreign currency.
- "Legal person" means a business entity;
- "Commercial paper" means all types of bank checks and payment orders, bills of exchange, promissory notes, other documents or means for debt settlement equivalent to foreign exchange that can be tradable or used for the international settlements;
- "Cash in foreign exchange" means the bank notes, the traveler's checks and other documents which are equivalent to cash;
- "Precious metal" means gold which may be used as a means for international settlement;
- "Commercial bank" means a licensed corporate entity conducting a banking business in accordance with the laws of the Lao PDR;
- "Resident of the Lao PDR" means:
 - (1). A person, a legal person being either a Lao or a foreigner residing in the Lao PDR conducting a licensed and registered business there in accordance with the laws of the Lao PDR; and a representative office of the aforementioned legal person located abroad;
 - (2). A Government organization, a civil society organization of the Lao PDR operating both inside and outside the Lao PDR;
 - (3). A Lao citizen residing in the Lao PDR;
 - (4). A Lao citizen residing abroad for less than one year;
 - (5). A Lao diplomatic personnel working at the Lao Embassy, Lao Consular and international organization abroad;
 - (6). A Lao citizen studying and receiving a medical treatment abroad;
 - (7). A foreigner or a non-citizenship individual having been lived permanently in the Lao PDR [sic];
 - (8). A foreigner working in the Lao PDR for more than one year, other than the diplomatic personnel of the foreign embassy and consular or international organization.

continued on next page

Box A1.5 continuation

- “Non-resident of the Lao PDR” means:

- (1). A person, a legal person residing abroad;
- (2). A foreign embassy, a consular, an international organization and their personnel; a foreign advisor, a foreign expert working in the Lao PDR, including their family members;
- (3). A foreigner living in the Lao PDR for less than one year;
- (4). A foreigner studying, traveling, visiting and receiving a medical treatment in the Lao PDR;
- (5). A representative office of a foreign legal person residing in the Lao PDR;
- (6). A Lao citizen living abroad for more than one year.

In case of encountering difficulty in classifying a person or a legal person to any of the foregoing category, a recommendation shall be addressed to the Governor of the Bank of the Lao PDR for consideration.

Article 3. The Use of Foreign Exchange

A person, a legal person shall not directly pay nor receive in foreign exchange for the goods and services rendered to them or by them, nor settle the debts in foreign exchange within the Lao territory, except for the case where the Bank of the Lao PDR has proposed [such] and approved by the Government.

A holder of foreign exchange who [needs] to make payment within the Lao PDR shall change [the foreign currency] to Kip at a commercial bank or at an authorized foreign exchange bureau by the Bank of the Lao PDR.

Those who need to use foreign exchange for any of the objectives stipulated in Article 5 of this Decree Law may purchase foreign exchange at a commercial bank or a foreign exchange bureau in accordance with the regulations of the Bank of the Lao PDR.

The price mark-up of a good and a service, including the value of financial obligations to the Government, shall be made in Kip, except for the case where the Bank of the Lao PDR has proposed [such] and approved by the Government.

Section II

Foreign Exchange Trading

Article 4. Purchase and Sale of Foreign Exchange

A person, a legal person shall purchase or sell foreign exchange through a commercial bank or a licensed foreign exchange bureau by the Bank of the Lao PDR.

A commercial bank has the right to buy banknotes, traveler’s checks and commercial papers equivalent to foreign exchange that may be tradable or used for the international settlements. A licensed foreign exchange bureau has the right to buy banknotes and traveler’s checks equivalent to foreign exchange from the public in accordance with the regulations of the Bank of the Lao PDR.

A commercial bank may participate in trading the foreign exchange in the inter-bank market and may sell foreign exchange to the public in accordance with the regulations promulgated by the Bank of the Lao PDR.

The Bank of the Lao PDR shall manage the inter-bank market operations and may participate in trading foreign exchange with the objective to increase the official foreign reserve and to conduct the monetary policy.

Article 5. Objectives of Sale and Use of Foreign Exchange

The sale of foreign exchange by commercial banks and the use foreign exchange by both resident and non-resident of the Lao PDR shall be carried out in accordance with the regulations issued by the Bank of the Lao PDR and its aims:

1. To pay for imported goods;
2. To pay for services related directly to import-export goods, such as transit transportation, insurance and transit warehousing charges;
3. To repay the foreign debts in accordance with the agreement approved by the Government or by the organization authorized by the Government;
4. To give an aid to a foreign country in accordance with the approval of the Government or the organization authorized by the Government;
5. To repatriate of profits, dividends, initial investments, interests, service charges of the foreign investors, and wages of foreign workers back to their home countries, or to transfer to a third country as stipulated in the Law Governing the Promotion and Management of the Foreign Investment in the Lao PDR;
6. For investment abroad with the Government approval;
7. For national budget expenditures;
8. For other spending targets in accordance with regulations of the Bank of the Lao PDR including medical treatment, studying, and visiting abroad.

The sale of foreign exchange by the licensed foreign exchange bureaus shall be carried out based on the following targets:

1. Sell to state-owned commercial bank or the Bank of the Lao PDR;
2. Sell to the general public in accordance with the regulations of the Bank of the Lao PDR.

Article 6. Right to Purchase Foreign Exchange

A person, a legal person, a government organization, civil society organization locating in the Lao PDR may purchase foreign exchange from a commercial bank in accordance with the regulations of the Bank of the Lao PDR, to be used for the objective as stipulated in the Article 5 of this Decree Law.

continued on next page

*Box A1.5 continuation***Article 7. Exchange Rate**

The Bank of the Lao PDR uses [a] market-oriented exchange system guided by state.

In case of financial crisis or unavailable market information for the purchase and sale of foreign currency, the Bank of the Lao PDR shall study and recommend, and submit to the Government for approval the exchange rate quotation to be implemented by commercial banks and foreign exchange bureaus.

The Bank of the Lao PDR shall study the exchange rate and recommend to the Government a regime that [is] deem[ed] suitable [to] the current stage of national socio-economic development from time to time.

Section III**Opening and Using Bank Deposit Accounts in Foreign Currency by Residents and Non-residents of the Lao PDR****Article 8. Opening and Using a Bank Deposit Account in Foreign Currency by a Resident and a Non-resident of the Lao PDR**

A person, a legal person as a resident, and a non-resident of the Lao PDR who legally earns foreign exchange may open a bank deposit account in foreign currency at a commercial bank within the Lao PDR and shall receive interest in foreign currency in accordance with the regulations of the commercial bank, and shall use the currency account in accordance with the Articles 3 and 5 of this Decree Law.

Article 9. Right to Hold and Use Foreign Exchange of Individuals [sic]

A person, as a resident and a non-resident of the Lao PDR, may hold foreign exchange, deposit it at a commercial bank within the Lao PDR, and use it in accordance with Articles 3 and 5 of this Decree Law.

Article 10. Opening and Using Bank Deposit Accounts in Kip of Non-residents of the Lao PDR

A non-resident of the Lao PDR may open a bank deposit account in Kip earned from selling foreign exchange to a commercial bank or a foreign exchange bureau at a commercial bank within the Lao PDR, and may use the balance in the account to repurchase foreign exchange.

Article 11. Opening and Using a Bank Deposit Account in a Foreign Country of a Resident of the Lao PDR

A person, a legal person as a resident of the Lao PDR, may open and use a bank deposit account in a foreign country with the approval of the Bank of the Lao PDR for the following objectives:

1. For the transit business such as: transportation by land, by air, by sea and by post; for insurance, tourism, labor exportation and contracting a construction project abroad;
2. For an externally borrowing and debt settlement [sic];
3. For the establishment of a branch or a representative office abroad, and for the operation of foreign exchange business abroad as approved by the concerned authorities;
4. For other objectives as approved by the concerned authorities.

A resident of the Lao PDR as approved to open a bank deposit account abroad has the duty to report the use of the account to the Bank of the Lao PDR in accordance with the regulations set by the Bank of the Lao PDR.

Article 12. The Management of the Foreign Currency Bank Deposit Accounts Opened within the Lao PDR and Abroad

The Bank of the Lao PDR shall set the rules regulations on the opening and usage of foreign currency bank deposit accounts by residents and non-residents of the Lao PDR held within the Lao PDR and abroad.

The commercial banks which accepted the application to open the foreign currency deposit accounts of residents and non-residents of the Lao PDR, and the Kip deposit accounts of the non-residents of the Lao PDR, shall examine the utilization of those accounts in accordance with this Decree Law and the regulations issued by the Bank of the Lao PDR.

The Bank of the Lao PDR shall supervise the services on foreign exchange [deposits] of the Government, commercial banks, and international financial institutions in accordance with this decree law and the specific regulations issued by the Bank of the Lao PDR.

Article 13. Supervision of the Earnings in Foreign Exchange

A person, a legal person resident in the Lao PDR dealing with international businesses, having revenues in foreign exchange, shall repatriate those revenues to the Lao PDR in accordance with the regulations of the Bank of the Lao PDR. The revenues shall be deposited in their bank account held at a commercial bank, and the utilization of the money in the account shall be complied with Articles 3 and 5 of this Decree Law.

A person, a legal person as a resident of the Lao PDR, dealing with local businesses that are allowed to charge in foreign exchange, shall deposit the foreign exchange in their bank account held at a commercial bank, and the utilization of the money in the account shall be complied with Articles 3 and 5 of this Decree Law.

All fiscal revenues in foreign exchange shall be deposited in the Government's account held at the Bank of the Lao PDR. Whenever in need [of] domestic payment, [this] shall be sold to the Bank of the Lao PDR at the daily exchange rate of the inter-bank market's trading.

continued on next page

*Box A1.5 continuation***Article 14. Bringing Cash in Foreign Currency and Precious Metals and in Kip In or Out of the Lao PDR**

A resident, a non-resident of the Lao PDR may bring cash in Kip, foreign currency, and precious metals in or out the Lao PDR in accordance with the regulations issued by the Bank of the Lao PDR from time to time.

Customs officers at an immigration check-point shall inspect the declaration of Kip, foreign currency, and precious metals to be brought in or out of the Lao PDR.

Section IV**Foreign Exchange Business of a Commercial Bank and a Foreign Exchange Bureau****Article 15. Licensing the Operations of Foreign Exchange Business**

The Bank of the Lao PDR shall issue and revoke the license for the operations of foreign exchange business of a commercial bank and a foreign exchange bureau.

A person, a legal person intended to run [a] foreign exchange business, shall complete a license application form and shall meet all requirements issued by the Bank of the Lao PDR from time to time.

A commercial bank and a licensed foreign exchange bureau shall operate their foreign exchange business within the limit stipulated in their license and shall comply with the laws, this Decree Law and other relevant regulations of the Lao PDR.

Article 16. The Notice of Foreign Exchange Rate

A commercial bank and a licensed foreign exchange bureau shall disseminate their exchange rates in a transparent manner that can be seen by customers and shall exchange on such rates.

Article 17. Lending in Foreign Exchange of a Commercial Bank

A commercial bank may lend the money to a person or a legal person or a resident of the Lao PDR in foreign exchange as agreed in accordance to the contracts between the commercial banks and the customers under the Law of Lao PDR.

Article 18. Fund Mobilization in Foreign Exchange

Commercial banks and other financial institutions licensed to run [a] foreign exchange may mobilize deposits, [and] issue bonds and commercial papers in foreign exchange to mobilize funds from the general public as approved by the Bank of the Lao PDR.

Article 19. Bringing Foreign Currency In or Out of the Lao PDR by Commercial Banks and Other Financial Institutions

Commercial banks and other financial institutions licensed to run [a] foreign exchange business may bring foreign currency in or out of the Lao PDR for their own business operation purposes in accordance with the current regulations issued by the Bank of the Lao PDR. The foreign exchange bureaus are not permitted to bring foreign currency in or out of the Lao PDR.

The customs officers at an immigration check-point shall inspect the declaration of foreign currency [brought] in or out of the Lao PDR by commercial banks and other financial institutions.

Article 20. Monitoring and Reporting on Foreign Exchange Business

Commercial banks, other financial institutions, and foreign exchange bureaus licensed to run foreign exchange shall be supervised by the Bank of the Lao PDR and shall comply with the current reporting regime issued by the Bank of Lao PDR.

Section V**Borrowing Funds and Grants****Article 21. External Borrowing of the Government**

The Ministry of Finance, the Bank of the Lao PDR, other concerned Ministries, and ministerial equivalents shall study and recommend to the Government any external borrowing. The Ministry of Finance and the Bank of the Lao PDR may be delegated by the Government to sign a loan contract or to issue a Government guarantee.

The Ministry of Finance shall implement the loan contracts and supervise the use of the Government loans including the loans to state enterprises.

The Bank of the Lao PDR shall hold the Government's account, provide services, and monitor the repayment of Government external debts.

Article 22. External Borrowing and the Management of External Commercial Credit

The Bank of the Lao PDR shall consider approving, supervising and monitoring the external borrowing of a person or a legal person residing in the Lao PDR.

continued on next page

Box A1.5 continuation

The Bank of the Lao PDR shall coordinate with other concerned macro-public organizations to manage commercial credit.

Article 23. External Lending

The Ministry of Finance, the Bank of the Lao PDR, other concerned Ministries, and ministerial equivalents shall study any external lending and recommend to the Government.

External lending of the legal persons from the state and private sectors shall be approved by the Bank of the Lao PDR.

Article 24. Management of Grants**1. Management of External Grants**

The Ministry of Finance shall centrally manage and compile the total external grants including the grants from non-government organizations in physical and cash values. The grants in foreign exchange shall be centrally placed in the account opened at the Bank of the Lao PDR.

Government agencies receiving grants from non-governments organization shall report to the Ministry of Finance and the concerned agencies to compile.

2. Management of Grants Given to Foreign Countries

The Ministry of Finance shall monitor and compile the grants given to foreign countries by the Government, legal persons, and civil society organizations in the Lao PDR.

Section VI**Investment****Article 25. Foreign Investment**

A person, a legal person investing in the Lao PDR, shall open accounts at a commercial bank incorporated in the Lao PDR for monitoring the fund [brought] in foreign currency and the usage of fund for business operations. The transfer of funds in foreign currency for investment in the Lao PDR shall be made through the banking system in accordance with the type of currency stipulated in the investment license and in accordance with the Law of the Lao PDR.

The investment in kind is the value of the equipment and tools that investors bring and pay foreign countries, then legally brought into the Lao PDR for the purpose of licensed business operations. Equipments and tools imported by utilising the foreign currency from the Lao PDR shall not be counted as investment in kind.

The Ministry of Planning and Investment shall monitor the investment of foreign investors in order to ensure the implementation of investment license and the Law on Foreign Investment Promotion and Management in the Lao PDR.

The Bank of the Lao PDR shall monitor and confirm the actual fund brought in as a reference for repatriating from the Lao PDR the principals, interests, profits, dividends and others related to the investment. Foreign investors who are unable to produce adequate evidence for their investment shall not be authorized by the Bank of the Lao PDR to repatriate the fund from the Lao PDR.

A person, a legal person licensed to invest in the Lao PDR shall declare their fund and prove the evidence of their fund brought in each time to the Bank of the Lao PDR.

Article 26. Fund Borrowed by Foreign Investors in the Lao PDR

After the transfer of the full registered capital as stipulated in the investment license has been complete, a foreign investor in the Lao PDR may borrow funds from the local banks in accordance with the Law of Commercial Banks of the Lao PDR.

Article 27. Transfer of Fund to Foreign Countries

A foreign investor may transfer his/her profits, dividends from business operations, and other legal incomes to his/her own country or a third country through the banking system in accordance with the law of the Lao PDR.

In the case where the investment period has expired, or the investment activities are partially or completely closed, the foreign investor may repatriate his/her investment fund to his/her own country or to a third country in accordance with the law of the Lao PDR.

Article 28. Investment in a Foreign Country of a Resident of the Lao PDR

A resident of the Lao PDR who intends to invest directly or indirectly in a foreign country shall be approved by the concerned authorized organization(s). Upon this approval, the transfer of fund to be invested abroad shall be approved by the Bank of the Lao PDR.

continued on next page

Box A1.5 continuation

Section VII Supervision of Precious Metal Business

Article 29. Creation and Supervision of Precious Metal Business

The Bank of the Lao PDR shall license and supervise an enterprise for importing and exporting the precious metals which are internationally accepted as a means of payment and raw materials for producing jewelry domestically.

A person or a legal person desiring to establish an export-import enterprise for precious metals, which are internationally accepted as a means of payment, shall submit the creation application form and shall comply with the current requirements issued by the Bank of the Lao PDR.

The Ministry of Industry and of Commerce shall license and supervise an enterprise for producing and selling the jewelry made from precious metals, including the importation and exportation of jewelry, precious stones, and precious metals mined and manufactured in the Lao PDR.

Article 30. The Bank of the Lao PDR's Business on Precious Metal

The Bank of the Lao PDR may buy and sell precious metals which are internationally accepted as a means of payment in domestic and foreign markets, and may import or export the precious metals for monetary policy purposes of the Government.

Section VIII Forecasting the Balance of Payment

Article 31. Compiling Revenue and Expenditure in Foreign Currency

The Bank of the Lao PDR shall compile the statistical revenue and expenditure in foreign currency of the national economy.

Ministries, ministerial equivalents, provinces, municipality, and social organizations shall compile the report of statistical data in foreign currency of enterprises and organizations under their supervision, and cooperate with the Bank of the Lao PDR staff who prepares the balance of payment.

Article 32. Payments to Foreign Countries

Settlement for imports and exports, international services, borrowing, grants, investments, interests, profits, dividends and revenue, and expenditure incurred between the Lao PDR and foreign countries shall be processed through the banking system in accordance with the Law of the Lao PDR.

Section IX Monitoring, Favor Policy for the Good Implementer and Measures Taken for the Violator [sic]

Article 33. Monitoring

Ministries, ministerial equivalents, municipality and provincial authorities shall monitor regularly the departments, enterprises and individuals under their supervision the implementation of this decree law.

Article 34. Favor policy for Good Implementers

Individuals [and/or] organizations that implement successfully this Decree Law shall be praised properly in accordance with regulations issued by the Bank of the Lao PDR.

Individuals [and/or] organizations that successfully monitored and supplied the evidence of the violation of this Decree Law and informed the concerned authority to seek the penalty of those who violate [the Decree Law] shall be rewarded in compliance with the regulations issued by the concerned authority.

Article 35. Measure for Violators

Individuals [and/or] organizations who violate this Decree Law shall be warned, fined, and prosecuted in accordance with the laws depending on the severity of the case [sic].

Article 36. Warning

Individuals [and/or] organizations who violate this Decree Law for the first time with low degree of severity shall be warned and recorded in writing by the concerned authorities at the place of violation.

Moreover, the violator shall comply with the regulations in accordance with the Law of the Lao PDR.

Article 37. Penalty

If individuals or organizations continue to violate the Decree Law after the warning, or they violate the decree law for the first time with high degree of severity, the violators shall be fined 50% of the value of the violation.

continued on next page

Box A1.5 continuation

In case that the violator has been fined but continued the violation, the violator shall be fined 100% of the value of the violation and the amount of money or precious metals used in the violation shall be confiscated to the Government budget. If the violator is a person or a legal person operating a business, his/her license shall be revoked.

In case of violation that is highly severe and heavily damages the economic, financial and monetary system of the country, the violator shall be prosecuted in accordance with the laws.

**Section X
Final Provisions****Article 38. Implementation**

Ministries, ministerial equivalents, provinces, Vientiane municipality and the related sectors of [the] economy shall disseminate and strictly implement this Decree Law.

Article 39. Effectiveness

This decree law supersedes Presidential Decree Law No. 01/OP dated August 9, 2002

This decree law is effective from the date of signature. Any decrees, regulations previously promulgated conflicting with this decree law shall be void.

The President of the Lao PDR
(Signature and Seal)
Chummaly Xaiyasom

Malaysia

Bond Market Guide

Contents

Acknowledgement	vii
I. Structure, Type, and Characteristics of the Market.....	1
A. Overview of the Market.....	1
B. Types of Bonds.....	2
C. Methods of Issuing Bonds	9
D. Bonds and <i>Sukuk</i> Listed under the Exempt Regime on Bursa Malaysia	9
E. Offers of Bonds to Professionals	10
F. Definition of “Sophisticated Investors” in Malaysia.....	10
G. Quick Reference on Sophisticated Investors.....	13
H. Credit-Rating Agencies and Credit Rating of Bonds	13
I. Financial Guarantee Institution	15
J. Governing Laws on Bond Issuance.....	15
K. Transfers of Interests in Bonds	17
L. Definition of Securities	17
M. <i>Sukuk</i>	18
N. Self-Governing Rules behind the Market.....	19
O. Investor Protection	21
P. Trustees.....	22
Q. Meetings of Bondholders	24
R. Bankruptcy Procedures.....	25
S. Event of Default.....	25
T. Currency of the Bonds	26
U. Parties Involved in Bond Issue and Their Respective Roles.....	26
V. Issuer.....	30
W. Investor	31
X. Authorized Depository Institution	32
Y. Quick Reference for Information on Cross-Border Issuance and Investment	32
II. Market Regulations in Malaysia	35
A. Market Entry Requirements for Non-Residents	35
B. Market Regulators.....	36
C. Related Regulations and Rules on Issuing Debt Instruments	39

D. Rules and Regulations on Investment in Debt Securities	40
E. Taxation Framework and Tax Requirements	40
F. Tax Incentives	41
III. Trading of Bonds and Trading Market Infrastructure	43
A. Over-the-Counter Market Trading.....	43
B. Exchange trading	43
C. Bond Market Infrastructure Diagram	44
D. Business Process Flowchart: Bond Market (Over-the-Counter Market)/Delivery versus Payment.....	44
E. Over-the-Counter Bond Transaction Flow for Foreign Investors.....	45
IV. Possible Items of Future Improvement.....	47
V. Description of the Securities Settlement System.....	48
A. Securities Settlement Infrastructure.....	48
F. Definition of Clearing and Settlement	49
VI. Presence of <i>Sukuk</i> Market	51
A. <i>Sukuk</i> Market.....	51
B. Structure of <i>Sukuk</i>	51
C. Growth and Acceptance of <i>Sukuk</i>	52
D. Malaysia as an Islamic Capital Market Center	52
E. Regulatory Framework for Islamic Finance	53
F. Types of Instruments Available, Segments, and Tenure.....	53
G. Basic Market Infrastructure Required to Facilitate Islamic Finance	54
H. Tax-Related Issues	54
VII. History of Debt Market Development	55
A. Market Development History	55
N. Regulatory Framework and Market Infrastructure Building	56
O. Regional Cooperation	59
VIII. Market Size and Statistics	60
A. Market Size.....	60
B. <i>Sukuk</i> Market.....	60
C. Equity Market	60
D. Size of Local Currency Bond Market	61
E. Size of Foreign Currency Bond Market in Percentage of Gross Domestic Product (Bank for International Settlement)	62
F. Size of Foreign Currency Bond Market in US Dollars (Local Sources)	63
G. Foreign Holdings in Local Currency Government Bonds.....	64
H. Domestic Financing Profile.....	65
I. Trading Volume	66
IX. Next Step ⇒ Future Direction: Extract from the Capital Market Masterplan II	67
A. Growth Prospects to 2020	67
B. Widen Access to the Bond Market.....	68
C. Growth Prospects for Bond Market to 2020	69
D. Expand International Intermediation Capabilities.....	69

E. Group of 30 Compliance	71
F. Group of Experts Barrier Report Market Assessment – Malaysia (April/2010)	72
Appendixes	74
Appendix 1.1 Extracts from the Capital Markets and Services Act 2007 (CMSA).....	74
Appendix 1.2 List of Registered Credit Rating Agencies.....	94
Appendix 1.3 List of Registered Bond Pricing Agency.....	94
Appendix 1.4 List of Guidelines.....	95
References	96

Boxes, Figures, and Tables

Boxes

Box 1.1 Framework for Sophisticated Investors.....	11
Box 1.2 Exemptions from Need for Trust Deed (1)	23
Box 1.3 Exemptions from Need for Trust Deed (2)	24
Box 9.1 Securities Commission Survey on International Expansion Plans of Intermediaries.....	70
Box A1.1 DIVISION 1: Proposals in Relation to Securities Proposals to be submitted to Commission Section 212	74
Box A1.2 Division 3: Prospectus	76
Box A1.3 DIVISION 4: Debentures	84
Box A1.4 B. Part VIII: Self-Regulatory Organisations	89

Figures

Figure 3.1 Bond Market Infrastructure Diagram (MY: T+2)	44
Figure 3.2 Business Process Flowchart: Over-the-Counter Market/Delivery versus Payment	44
Figure 3.3 Over-the-Counter Bond Transaction Flow for Foreign Investors	45

Tables

Table 1.1 Quick Reference on Sophisticated Investors	13
Table 1.2 Categories of Principal Advisers and Permitted Types of Corporate Proposals	27
Table 1.3 Quick Reference on Cross-Border Issuance and Investment in Malaysia	32
Table 5.1 Market Charges	50
Table 7.1 Strategic Development Initiatives for the Malaysian Bond Market	55
Table 7.2 Implementation Plan for the Capital Market Masterplan	58
Table 8.1 Size of Local Currency Bond Market in USD (Local Sources) (% GDP)	61
Table 8.2 Foreign Currency Bonds to Gross Domestic Product Ratio.....	62
Table 8.3 Foreign Currency Bonds Outstanding (Local Sources)	63
Table 8.4 Foreign Holdings in Local Currency Government Bonds (MYR billions)	64
Table 8.5 Domestic Financing Profile	65
Table 8.6 Trading Volume (\$ billions)	66
Table 9.1 Group of Thirty Compliance	71
Table 9.2 Barrier Report Market Assessment for Malaysia	72
Table A1. List of Registered Credit Rating Agencies	94

Acknowledgement

The Asian Development Bank (ADB) Team, comprising Satoru Yamadera (Economist, ADB Office of Regional Economic Integration, - September 2011), Seung Jae Lee (Principal Financial Sector Specialist), Shinji Kawai (Senior Financial Sector Specialist, Banking), Shigehito Inukai (ADB consultant), Taiji Inui (ADB consultant), and Matthias Schmidt (ADB consultant), would like to express their sincere gratitude to national members and expert institutions: Securities Commission Malaysia (SC), Bank Negara Malaysia, CIMB Investment Bank Berhad, and Bond Pricing Agency Malaysia (BPAM). They kindly provided answers to the questionnaires prepared by the ADB Team, thoroughly reviewed the draft of the Market Guide, and gave their valuable comments.

The ADB Team also would like to express special thanks to Citibank, Deutsche Bank AG, HongKong Shanghai Banking Corporation (HSBC), J.P. Morgan, and State Street for their contribution as international experts to provide information from their respective market guides, as well as their valuable expertise. Because of their cooperation and contribution the ADB Team started the research on solid ground.

Last but not least, the Team would like to thank all the interviewees who gave their comments and responses to questions during the market consultations.

It should be noted that any part of this report does not represent the official views and opinions of any institution which participated in this activity as the ABMF members and experts. The ADB Team bears responsibility for the contents of this report.

February 2012

Asian Development Bank (ADB) Team

List of Interviewees:

Kuala Lumpur, 11 May 2011
Deutsche Bank AG Malaysia
Citibank Malaysia
Rahmat Lim & Partners
Bank Negara Malaysia (BNM)
CIMB Malaysia
Securities Commission Malaysia (SC)

I. Structure, Type, and Characteristics of the Market

A. Overview of the Market

The Malaysian bond market is one of the most developed and dynamic bond markets in the region. It is the largest local currency bond market in the Association of Southeast Asian Nations (ASEAN). As of 31 December 2011, the market has reached the size of MYR848 billion (equivalent to \$282.3 billion).

This phenomenal development of the Malaysian bond market has largely been achieved through the exceptional growth of the corporate bonds and *Sukuk* markets. Malaysia's well-developed government bond market is complemented by a sizeable corporate bond market, which constituted 40% of the market size as of the end of the third quarter of 2011.¹ Malaysia's bond market is predominantly offered to and traded by sophisticated investors, which are generally associated to those listed in Schedule 6 and 7 under the *Capital Market and Services Act 2007* (CMSA) Appendix 1.1A.

The market also offers a wide range of instruments, considering the fact it has the largest *Sukuk* market in the world. *Sukuk*, or Islamic bonds which are issued on Islamic principles, play a major role in Malaysia's capital market development. With the *Sukuk* market providing the springboard, the past decade has also witnessed the rapid growth of Malaysia's Islamic capital market.

A testament to the significance of the Malaysian fixed-income market in the global bond markets is its inclusion in a number of global indices, such as the inclusion of Malaysian government bonds in the World Government Bond Index, which is one of the most referenced benchmark market indices by the international investing community, as well as in the Barclays Global Aggregate Index. Malaysian government *Sukuk* are also included in the Dow Jones Citigroup *Sukuk* Index, the world's first *Sukuk* index. Malaysia has allowed a diverse group of foreign entities to issue ringgit-denominated bonds in the country. By the end of September 2011, 34.5% of Malaysian government bonds outstanding were held by foreign investors, compared with 21.5% by the end of December 2010 and 18.1% by the end of June 2010.

¹ As of September 2011 based on data from AsianBondsOnline. http://asianbondsonline.adb.org/malaysia/data/bondmarket.php?code=LCY_in_USD_Local

Domestic and foreign investors can buy and sell conventional and Islamic debt instruments through over-the-counter (OTC) markets. Rules on hedging have been liberalized to allow residents and non-residents into hedging arrangements with licensed offshore banks.

In Malaysia, nearly all securities are scripless, with securities transferred electronically via Bank Negara Malaysia (BNM)'s Real-Time Electronic Transfer of Funds and Securities (RENTAS) system, which is operated by its wholly-owned subsidiary, Malaysian Electronic Clearing Corporation (MyClear). Transfer instructions are conducted on a trade-by-trade basis.

Securitization in Malaysia began in 2001, following the introduction of the Asset-Backed Securities Guidelines by Securities Commission Malaysia. The special purpose vehicle (SPV) set up by National Mortgage Corporation (Cagamas) is currently the largest issuer of securitized instruments in Malaysia through the securitization of housing loans of government staff. Cagamas is also an active issuer of bonds in Malaysia.

In 2004, the Securities Commission Malaysia (SC) on its website allowed public access to the Principal Terms and Conditions for all corporate bond and *Sukuk* issuances approved by the SC. Full access to all issuance documents, however, was made available to Schedule 6 CMSA investors upon subscription. This facility allows investors to utilize the information available and enables them to make their own evaluation on the merits and risks of the investment.

In 2006, BNM launched Bond Info Hub, a one-stop centre detailing all bond-related information in Malaysia. Bond Info Hub is a single source of information on the Malaysian bond market for the global investment community. In addition to being a key initiative to promote the domestic bond markets, Bond Info Hub acts as a conduit to correct misconceptions, especially among foreign investors, about the state of market development in Malaysia. Also in 2006, the Securities Commission issued Guidelines on the Registration of Bond Pricing Agencies to complement the government's objective of building more efficient and liquid bond and *Sukuk* markets.

B. Types of Bonds

Malaysia's local currency bond market is active for both conventional and Islamic bonds. A futures market is also available for Malaysian government securities. Investors may employ different investment and risk management techniques. Also, licensed and non-financial institutional investors may enter into repo and reverse-repo transactions.

1. By Issuer Category

a. Bonds Issued by Public Entities

i. Government Securities

The types of government debt securities and *Sukuk* include:

(1) Malaysian Government Securities

Malaysian Government Securities (MGS) are long-term bonds issued by the

government to raise funds from the local financial market. These coupon-bearing bonds are the most actively traded bonds in the Malaysian bond market. Aside from MGS, callable MGS have also been issued in 2006 to provide the government an alternative to “redeem the bond ahead of its maturity date”²

(2) Malaysian Treasury Bills (MTB)

Malaysian Treasury bills (MTBs) are “short-term securities issued by BNM on behalf of the government. Treasury bills are used for working capital.”³

(3) Malaysian Islamic Treasury Bills (MITB)

Malaysian Islamic Treasury bills (MITBs) are short-term securities issued by the Government of Malaysia based on Islamic principles. MITBs are usually issued on a weekly basis, with original maturity of 1 year.

(4) Government Investment Issues

“Government investment issues (GIIs) are non-interest-bearing government securities based on Islamic principles issued by the government and placed on a competitive tender with maturities of 3 to 10 years. Funds are used for development expenditures.”⁴

(5) Sukuk Simpanan Rakyat

Sukuk Simpanan Rakyat, issued on a scripless basis by BNM on behalf of the government, is an investment instrument for Malaysian citizens who are 21 years old and above.

(6) Merdeka Savings Bonds

These are scripless bonds structured on Shariah principles. These bonds represent an additional savings instrument for Malaysian citizens who are 56 years old and above.

Merdeka savings bonds are “targeted at retirees by offering a slightly higher return than the market rate, and a tax exemption. A unique feature of [the] *Merdeka* savings bonds is that they are all based on the Islamic banking concept of *bai’ al-inah* (sell-and-buy-back arrangement).”⁵

ii. Bank Negara Monetary Notes (BNMN)

(1) Bank Negara Monetary Notes

Bank Negara Monetary Notes (BNMNs) are discounted or coupon-bearing government securities with maturities of 91, 182, 364 days, and 1 to 3 years. BNMNs are issued for the purpose of managing liquidity in both conventional and Islamic financial markets, and can be discount-based or coupon-based. “BNMNs are offered through competitive auction through principal dealers.”⁶ The maximum maturity of BNMN is 3 years. BNMNs replaced the Bank Negara Bills and Bank Negara Negotiable Notes.

(2) Floating Rate Bank Negara Monetary Notes

Floating Rate Bank Negara Monetary Notes (BNMNF) are instruments used for

² AsianBondsOnline. http://asianbondsonline.adb.org/malaysia/structure/instruments/bond_types.php

³ Footnote 2.

⁴ Footnote 2.

⁵ Footnote 2.

⁶ Footnote 2.

implementing monetary policy and in managing liquidity in the financial market. Floating rate BNMN issuance is conducted through competitive Dutch auction (uniform price) via the Principal Dealer network where market participants bid the tender based on spread.

iii. *Sukuk* Bank Negara Malaysia Issues

Sukuk Bank Negara Malaysia Ijarah (SBNMI) are zero-coupon bonds with maturities of 1 to 2 years. SBNMI are based on the concept of sale and lease back (*al-Ijarah*).⁷ A special-purpose vehicle (SPV) has been established to issue the *Sukuk* Ijarah.

b. Bonds and Notes Issued by Private Entities

Financial institutions are the main issuers of corporate bonds and notes.

i. Financial Institutions

ii. Local and Foreign Corporates

The types of corporate bonds issued on the Malaysian capital market are classified as straight, convertible, bonds with warrants, floating rate, zero coupon, mortgage bonds, Islamic bonds, secured and unsecured bonds, and guaranteed bonds.

(1) Medium-Term Notes

As the name implies, medium-term notes (MTNs) are debt papers issued on a medium-term basis, with tenures of more than 1 year and redeemable at par on maturity. They may carry fixed- or floating-rate coupons, and may be issued both on conventional and Islamic principles and by direct placement or tender. Based on the Private Debt Securities Guidelines of the SC of Malaysia, which was revised in August 2011, if a debt program involves an issuance of commercial papers (CPs) or a combination of MTNs and CPs, the tenure for such programs must not exceed 7 years. For a stand-alone MTN program, the 7-year tenure restriction does not apply.

Islamic MTNs provide semi-annual dividends depending on the structure used. This type of instrument was introduced to bridge the gap between short-term CPs and long-term corporate bonds. They differ from corporate bonds in that they are sold in relatively small amounts either on a continuous or on an intermittent basis. This type of debt program is used by a company to obtain a constant stream of cash flow from its debt issuance. It allows a company to tailor its debt issuance to meet its financing needs, only tapping the market for funds as and when required.

MTNs allow a company to register with the SC only once, instead of registering for every issue with differing maturities.

(2) Floating-Rate Notes

Floating-rate notes (FRNs) are debt securities with variable (floating) interest rates that are linked to those in the money markets. Their tenures range from 3 to 7 years. FRNs are usually pegged at a fixed spread to interbank rates corresponding to the maturity periods of the notes. In contrast to a coupon rate that is fixed for the entire life of the bonds, the coupon rate for FRNs is pegged to an agreed benchmark. It is

⁷ Footnote 2.

periodically reset at a stated margin over a reference rate, usually the Kuala Lumpur Interbank Offered Rates (KLIBOR), e.g., the 6-month KLIBOR for semi-annual coupons, or 12-month KLIBOR for coupons payable annually.

FRN investors are usually financial institutions with floating rate liabilities. Other investors use FRNs as substitutes for money market instruments and as hedges against rising interest rates.

(3) Commercial Paper

A CP is a short-term revolving promissory note, with maturities from 1 month to 1 year. In practice, a CP is often rolled over upon maturity until the expiry of the issue program. Most investors hold CPs until maturity as these are short term in nature.

(4) Notes Issuance Facility

Under this facility, a borrower can issue short-term notes of less than 1 year maturity, with common tenures being 1, 3 and 6 months. The tenure of the facility typically ranges from 3 to 5 years. The notes are issued in specific denominations and sold at a discount to their face value. The total amount of outstanding notes is capped by the approved facility amount.

The notes are subscribed by participating investors, normally financial institutions. Upon maturity, the notes are either redeemed at par or the principal is rolled over with the issuance of new notes. In the latter scenario, the discounted interest is paid to note holders at the time of the rollover.

The notes issuance facility (NIF) is a low-cost substitute for syndicated bank loans since its rates are pegged to the KLIBOR and not to the base lending rate (BLR), as in the case of bank loans.

(5) Revolving Underwritten Facility and Revolving Underwritten Notes Issuance Facility (RUNIF):

When the NIF includes underwriting services, the arrangement takes the form of a revolving underwritten facility (RUF) or revolving underwritten notes issuance facility (RUNIF). In the event that the notes are undersubscribed, the underwriters are committed to take up the unsold portion at a pre-determined rate.

(6) Multilateral Development Banks

The World Bank defined Multilateral Development Banks (MDBs) as institutions that provide financial support and professional advice for economic and social development activities in developing countries. The term Multilateral Development Banks typically refers to the World Bank Group and four Regional Development Banks:

- (i) World Bank
- (ii) African Development Bank
- (iii) Asian Development Bank
- (iv) European Bank for Reconstruction and Development
- (v) Inter-American Development Bank Group⁸

⁸ WorldBank. <http://web.worldbank.org/WBSITE/EXTERNAL/EXTABOUTUS/0,,contentMDK:20040614-menuPK:41699-pagePK:43912-piPK:44037-theSitePK:29708,00.html>

(7) Other Types of Government-Related Bonds

(a) **Khazanah Bonds**

Khazanah bonds are issued by Khazanah National, the investment holding arm of the Government of Malaysia. These unsecured zero-coupon bonds are based on the Islamic principles of *murabahah*,⁹ with maturities of 3, 5, 7 or 10 years.

(b) **Cagamas Bonds**

Securities issued by Cagamas are called Cagamas bonds (CAGB) in the domestic market.

Cagamas papers are unsecured bearer bonds issued by Cagamas, the national mortgage corporation established in 1986 to promote the secondary mortgage market in Malaysia. Cagamas issues debt securities and *Sukuk* to finance the purchase of housing loans and other consumer receivables from financial institutions, selected corporations, and the government. It is the second largest issuer of securities after the Government of Malaysia, and the major issuer of asset-backed securities in Malaysia. Various types of Cagamas papers are available in the market:

- (i) **Cagamas fixed-rate bonds.** These have tenures of 1.5 to 10 years with fixed coupon rates determined through tenders submitted by principal dealers. Interest is paid semi-annually.
- (ii) **Cagamas floating-rate bonds.** These have tenures of up to 10 years and an adjustable interest rate pegged to the 3- or 6-month KLIBOR. The interest rate is reset every 3 or 6 months, with interest paid at those intervals.
- (iii) **Cagamas notes (CAGN).** CAGNs are short-term instruments with maturities of 1 to 12 months, and issued at a discount from face value to reflect the implied interest rate.
- (iv) **Sanadat Mudharabah Cagamas (SMC).** SMCs are Islamic bonds issued under the Islamic principle of *mudharabah* (profit sharing) to finance the purchase of Islamic home-financing debts, granted on the basis of *bai' bithaman ajil*¹⁰ and the purchase of Islamic hire-purchase debts, which are allowed under the principle of *ijarah thumma al-bai*.¹¹ They are redeemable at par at maturity unless there is principal diminution. Tenures extend up to 10 years.
- (v) **Cagamas Bithaman Ajil Islamic Securities (CAGABAIS).** Formerly known as *Sanadat ABBA* Cagamas (SAC), CAGABAIS are Islamic bonds issued under the Islamic principle of *bai bithaman ajil* to finance the purchase of Islamic home-financing debts and Islamic hire-purchase debts. The bonds

⁹ According to Financial Islam.com, *murabaha* is a form of sale where the cost of the goods to be sold as well as the profit on the sale is known to both parties. The purchase and selling price and the profit margin must be clearly stated at the time of the sale agreement. Payment of the *Murabaha* price may be in spot, in instalments or in lump sum after a certain period of time.

¹⁰ *Bai' bithaman ajil* means deferred payment scale.

¹¹ *ijarah thumma al-bai* means hire purchase.

are redeemable at par together with the dividend due on maturity date. They also have tenures of up to 10 years.

2. By Type of Bonds

a. Straight Bonds (Government Bonds and/or Corporate Bonds)

These are bonds with a fixed coupon rate, maturing on a date fixed at the time of issue. They are called “plain vanillas” in some debt markets, as these bonds do not have any enhancement like warrants attached to them, or additional features such as put or call options. They also tend to carry relatively higher coupon rates. Coupon or interest payments are made either semi-annually or annually. Upon maturity, the principal or par value is paid to the bond holder.

b. Floating-Rate Notes

Please refer to page 8 for details.

c. Zero-Coupon Bonds

Zero-coupon bonds are fixed-income securities sold at a discount. They pay no periodic interest or coupon, and have a final redemption value equal to par. The difference between the purchase price and the redemption value equals the return on the investment.

Funds are not blocked off until maturity, as investors are free to trade the bonds and, if necessary, liquidate the bonds for cash.

d. Islamic Bonds

Islamic bonds, also called *Sukuk*, are structured to comply with Shariah principles, which prohibit the charging of interest.

Malaysian authorities have taken the lead in developing and innovating new Islamic securities structures and in pioneering the Islamic capital market.

e. Medium-Term Notes

Please see discussion on MTNs on page 8.

f. Convertible Bonds

Convertible bonds are fixed-rate securities that grant the bondholders the right to convert the bonds into a specific number of the issuer’s common shares at a predetermined conversion rate and price. This feature makes convertible bonds more desirable to prospective purchasers seeking a combination of equity and fixed-income features. Convertible bonds appeal to investors who seek both cash flow and safety of a bond while still enjoying the prospects of capital appreciation should the company’s ordinary shares perform well.

g. Bonds with Warrants

Fixed-rate bonds are commonly issued with detachable warrants (or transferable subscription rights). A warrant is a type of deferred-rights issue that gives the holder the option to purchase a specified number of the issuer’s shares at a set price (exercise price) within a certain time period (exercise period). The exercise price of a warrant is predetermined and is the price that would have to be paid by a warrant holder to

convert his warrants into ordinary shares. The warrants are usually detached from the bonds and sold to a different group of investors. Both instruments are then traded separately. Investors find it an attractive option to buy shares at a predetermined price, although at the outset the cost of the warrant is effectively subsidizing the issuer's borrowing cost.

Bonds with warrants allow listed companies to raise capital, initially in the form of debt and subsequently in the form of equity, at a premium to its current share price and at a lower interest cost than would be achievable through a straight-bond issue. When the warrants are exercised, new money is used to subscribe for the shares, increasing the borrower's capitalization. This is in contrast to a convertible bond where an exchange of shares for bonds takes place.

As a warrant entitles the bondholder to an option to purchase a specified amount of the company's shares, bonds issued with warrants have low coupon rates to compensate the issuers.

In addition, there are also stapled securities issued in the market. These are debt securities issued with preference shares, which enable the issuer to pass on its tax credit to the holders of the papers.

h. Asset-Backed Securities

Asset-backed securities (ABS) are securities backed by assets. Among others, these assets could be mortgages, loans or receivables. ABS are also issued based on Islamic principles in Malaysia. Apart from mortgage-backed securities (MBS), other examples of ABS are collateralized loan obligations and securitization of receivables.

Cagamas is the pioneer in local residential MBS.

3. Money Markets Instruments

a. Commercial Paper

Commercial papers refer to either conventional or Islamic short-term papers issued with original tenor of 1 year or less.

b. Repo

A repo is a contract to sell and, subsequently, repurchase securities at a specified date and price. It is also known as buyback arrangement.

4. By Listing Status

a. Debt Securities and *Sukuk* Listed and Traded on Bursa Malaysia

Debt securities listed on the exchange, called loan stocks, have three types:

(a) Redeemable Convertible Loan Stocks

These are debt securities that give the holders the right to convert the loan stocks into new ordinary shares during a specified period at a predetermined conversion rate and price. The issuer has the obligation to redeem the loan stocks at par upon maturity, together with interest, if the loan stocks have not been converted into shares.

(b) Irredeemable Convertible Loan Stocks

These are debt securities that confer the holders the right to convert the stocks into new ordinary shares. Nonetheless, the issuer will not redeem the stocks and such stocks will automatically be converted into ordinary shares on maturity.

(c) Redeemable Non-convertible Loan Stocks

These are debt securities that cannot be converted into ordinary shares. The company is obligated to redeem the loan stocks upon maturity.

b. Debt Securities and *Sukuk* Traded Over the Counter

Debt securities and *Sukuk* that are traded over the counter are those issued, offered, or subscribed in accordance with Sec. 229(1) and Sec. 230(1) of CMSA. These bonds can be listed under Bursa Malaysia's Exempt Regime, but not traded on Bursa Malaysia.

C. Methods of Issuing Bonds**1. Auction**

Auction is undertaken by BNM for government bonds and Principal Dealers for BNM notes.

a. Auction by BNM

BNM, via competitive auction, issues government bonds on behalf of the government. Successful bidders are determined according to the lowest yields offered, and the coupon rate is fixed at the weighted average yield of successful bids.

b. Auction by Principal Dealers

Principal Dealers offer BNM notes through competitive auction.

2. Direct Placement or Tender

Bonds issued by other statutory bodies and government-owned corporations, as well as corporate bonds, are issued via direct placement or tender.

D. Bonds and *Sukuk* Listed under the Exempt Regime on Bursa Malaysia**1. Listing of Bonds and *Sukuk* in Bursa Malaysia**

The term "sophisticated investor" is not explicitly defined in the CMSA. However, Schedules 6 (Sec. 229) and 7 (Sec. 230) (see Appendix) of the CMSA exempt these type of issues and offers to sophisticated or professional investors and their transactions from prospectus requirements.

To promote the Malaysian debt securities and *Sukuk* market while enhancing the breadth and depth of investment options on the Malaysian capital market, debt securities and *Sukuk* can now be listed on Bursa Malaysia under a new exempt regime by both listed and non-listed issuers. Under an exempt regime, debt securities or *Sukuk* which are listed on the Exchange will not be quoted nor traded on the Exchange. Debt securities or *Sukuk* listed on the Exchange may be denominated in foreign currencies but must have original maturity of more than 1 year.

For the features under an exempt regime, refer to Bursa Malaysia's Chapter 4B on listing under an exempt regime.¹²

2. Size of the Market

Listing under the Bursa Malaysia exempt regime currently comprises of 17 *Sukuk* issuers and five conventional bonds issuers. The total listed foreign currency *Sukuk* and bonds amounted to USD6.65 billion, SGD1.5 billion and CNY500 million, respectively. Total listed Malaysian ringgit-denominated *Sukuk* and bonds amounted to MYR16.7 billion with Cagamas MBS topping the list with MYR4.12 billion conventional bonds and MYR3.37 billion *Sukuk*, respectively. More details may be found in the Bursa Malaysia website on listed bonds under an exempt regime.¹³

E. Offers of Bonds to Professionals

According to Schedules 6 and 7 of the CMSA, professional investors are referred to as 'sophisticated investors':

- (i) A holder of a Capital Markets and Services Licence who carries on the business of dealing in securities.
- (ii) A holder of a Capital Markets and Services Licence who carries on the business of fund management.
- (iii) A licensed offshore bank under the *Offshore Banking Act 1990*.
- (iv) A licensed offshore insurer under the *Offshore Insurance Act 1990*.
- (v) A licensed institution under the *Banking and Financial Institution Act 1989* or an Islamic Bank under the *Islamic Banking Act 1983*.
- (vi) An insurance company registered under the *Insurance Act 1996*.

As stated above, under the exempt regime, prospectus exemption is adapted to the offers of bonds to sophisticated investors.

F. Definition of "Sophisticated Investors" in Malaysia

In Malaysia, a definition for sophisticated investors exists under items 9, 10, and 11 of Schedules 6 and 7 of the Capital Markets and Services Act. The background on the review of the categories of investors who are referred to as 'sophisticated investors' and the current framework of 'So-called Sophisticated Investors' are explained as follows:

¹² Bursa Malaysia. http://www.bursamalaysia.com/website/bm/regulation/rules/listing_requirements/

¹³ Footnote 8. http://www.bursamalaysia.com/website/bm/market_information/listed_bonds/exempt_regime.htm

Box 1.1 Framework for Sophisticated Investors

2.1 Current framework

2.1.1 The determination as to whether an investor is a “sophisticated investor” or a “retail investor” is important for several reasons.

First, only sophisticated investors should have access to complex and risky capital market investment products such as structured products and units in wholesale funds.^a

This approach is consistent with the SC’s regulatory policy of not encouraging retail investors to have exposure to complex investment products, as retail investors may not have the necessary knowledge and risk tolerance to invest in such products.^b

Second, the disclosures that are to be made to retail investors are more extensive and prescriptive as opposed to the disclosures that are made to sophisticated investors. For example, when an offering of securities is made to retail investors, the offering must be accompanied with a registered prospectus.

2.1.2 The term “sophisticated investor” is not explicitly defined in the Capital Markets and Services Act 2007 (CMSA). However, **Schedules 6 and 7** of the CMSA **exempt the following investors and transactions from prospectus requirements:**

- (a) A unit trust scheme or prescribed investment scheme;
- (b) A holder of a Capital Markets and Services Licence who carries on the business of dealing in securities;
- (c) A holder of a Capital Markets and Services Licence who carries on the business of fund management;
- (d) The aggregate consideration for the acquisition is not less than MYR250,000 or its equivalent in foreign currencies for each transaction whether such amount is paid for in cash or otherwise;
- (e) An individual whose total net personal assets exceed MYR3 million or its equivalent in foreign currencies;
- (f) A corporation with total net assets exceeding MYR10 million or its equivalent in foreign currencies based on the last audited accounts;
- (g) A licensed offshore bank under the Offshore Banking Act 1990;
- (h) A licensed offshore insurer under the Offshore Insurance Act 1990;
- (i) A licensed institution under the Banking and Financial Institution Act 1989 or an Islamic Bank under the Islamic Banking Act 1983;
- (j) An insurance company registered under the Insurance Act 1996;
- (k) A statutory body established by an Act of Parliament or an enactment of any State; and
- (l) A pension fund approved by the Director General of Inland Revenue.

1.1.3 The above classification was adopted in year 2000 by the Securities Commission (“SC”) when the prospectus requirements for the offer and invitation of securities were moved from the Companies Act 1965 to the Securities Commission Act 1993 via the Securities Commission (Amendment) Act 2000.

1.1.4 In drafting the excluded offers above, the SC has adopted and expanded the exempted offers list which existed under section 47B of the Companies Act 1965 and the Companies (Exempt Purchasers) Order 1997. Since year 2000, no review has been undertaken on the classification of “sophisticated investors”.

1.1.5 Although the original intention behind Schedules 6 and 7 of the CMSA (Schedules 6 and 7 of CMSA were in fact Schedules 2 and 3 of the Securities Commission Act 1993.) was to clarify situations when an offer of securities would not need to be accompanied with a registered prospectus, over time, the use of the Schedules have expanded and are now used as a means to determine who are sophisticated investors for the purposes of offering complex investment products.

3.1 Qualifying criteria and classification of “sophisticated investors”

3.1.1 Our research indicates that the qualifying criteria to determine whether a person is a “sophisticated investor” can be either one or more of the following:

- (a) the financial means test where consideration would be given to the net assets, portfolio of investments held by the investor or the income earned by the investor.

In some jurisdictions, this test may take into account assets, portfolio of investments or income that is held or received jointly by the investor and his immediate family members.

Where these criteria are imposed on an individual and that individual satisfies the criteria, that individual is usually referred to as a high net worth individual. Where an entity satisfies this criteria, that entity is then referred to as a high net worth entity; and

Box 1.1 continuation

- (b) the requisite knowledge test where consideration is given to the knowledge that is presumed to be held or exhibited to be held by the investor.

Some jurisdictions impose the knowledge test as an additional criterion that must be satisfied by an individual who has met the financial means test.

The reason for imposing this additional knowledge requirement is that once it is satisfied, certain processes in respect of sales practices need not be observed when dealing with such investors.

In some cases, the investor concerned is deemed to have such knowledge where it involves entities which have been licensed or whose ordinary course of business includes making investments.

These include licensed banks, corporations, unit trust funds, collective investment schemes[,] and those who hold a licence to carry out a regulated activity.

This category of sophisticated investors is commonly referred to as **professional investors**.

3.6 Professional investors

3.6.1 Professional investors, by virtue of their experience and knowledge [,] would be in a better position to make informed decisions and protect their own interests.

3.6.2 Within Schedules 6 and 7 of the CMSA, professional investors would include—

- a. A holder of a Capital Markets and Services Licence who carries on the business of dealing in securities;
- b. A holder of a Capital Markets and Services Licence who carries on the business of fund management;
- c. A licensed offshore bank under the Offshore Banking Act 1990;
- d. A licensed offshore insurer under the Offshore Insurance Act 1990;
- e. A licensed institution under the Banking and Financial Institution Act 1989 or
- f. an Islamic Bank under the Islamic Banking Act 1983; and
- g. An insurance company registered under the Insurance Act 1996.

^a For example, the Guidelines on the Offering of Structured Products provides that an issue, offer or invitation of unlisted structured products can only be made to investors listed in Schedules 2 and 3 of the SCA (now Schedules 6 and 7 of the Capital Markets and Services Act). The Guidelines on Wholesale Funds states that units in a wholesale fund can only be offered to qualified investors. A qualified investor is an individual whose total net personal assets exceed MYR3 million or its equivalent in foreign currencies, or a corporation with total net assets exceeding MYR10 million or its equivalent in foreign currencies based on the last audited accounts.

^b Moving forward the SC may consider whether retail investors should have exposure to some of these products, particularly structured products and unlisted debt securities. Exposing retail investors to such products, however, will be complemented with an enhanced sales practices regime. Proposals to enhance the existing sales practices regime are further discussed in Part 2 of this paper.

Note: Emphases added by the authors.

Source: Public Consultation Paper No. 1/2010. Review of Sophisticated Investors and Sales Practices for Capital Market Products, Securities Commission.

Sec. 229 of the CMSA defines excluded offers or excluded invitations, and Sec. 230 defines excluded issues.

Both Schedule 6 and Schedule 7 specify certain provisions in Division 3 that a prospectus shall not apply to “excluded offers” or “excluded invitations” and “excluded issues”.

An information memorandum issued by a person or his agent purporting to describe the business and affairs of the person in respect of any excluded offer or excluded invitation shall, however, be deemed to be a prospectus as it relates to the liability of the person or his agent for any statement or information that is false or misleading, or from which there is a material omission.

G. Quick Reference on Sophisticated Investors

Table 1.1 Quick Reference on Sophisticated Investors

	Sophisticated Investor		
	Sophisticated Investor	Professional Investor	Qualified Investor
a. A unit trust scheme or prescribed investment scheme;	✓		
b. A holder of a Capital Markets and Services Licence who carries on the business of dealing in securities;	✓	✓	
c. A holder of a Capital Markets and Services Licence who carries on the business of fund management;	✓	✓	
d. The aggregate consideration for the acquisition is not less than MYR250,000 or its equivalent in foreign currencies for each transaction whether such amount is paid in cash or otherwise;	✓		
e. An individual whose total net personal assets exceed MYR3 million or its equivalent in foreign currencies;	✓		✓
f. A corporation with total net assets exceeding MYR10 million or its equivalent in foreign currencies based on the last audited accounts;	✓		✓
g. A licensed offshore bank under the Offshore Banking Act 1990;	✓	✓	
h. A licensed offshore insurer under the Offshore Insurance Act 1990;	✓	✓	
i. A licensed institution under the Banking and Financial Institution Act 1989 or an Islamic Bank under the Islamic Banking Act 1983;	✓	✓	
j. An insurance company registered under the Insurance Act 1996;	✓	✓	
k. A statutory body established by an Act of Parliament or an enactment of any State;	✓		
l. A pension fund approved by the Director General of Inland Revenue;	✓		

Source: Schedules 6 and 7 of the *Capital Markets and Services Act, 2007*, as amended.

H. Credit-Rating Agencies and Credit Rating of Bonds

There are two credit-rating agencies (CRAs) in Malaysia that provide independent opinions on the credit risks and potential default risks of specific issuers. The first rating agency, Rating Agency Malaysia (now known as RAM Ratings Services, RAM), was established in November 1990; and the second, Malaysian Rating Corporation (MARC), was incorporated in October 1995.

Malaysia is one of the first countries in the world to require the recognition of CRAs for rating a bond or *Sukuk* issue. This is in recognition of their vital role in evaluating the probability of default of debt securities or a *Sukuk* issue, and the importance investors place on ratings for their investment decisions, despite the fact that all rating reports carry a disclaimer expressly stating that “a rating is not a recommendation to purchase, sell or hold a security’s market price or its suitability for a particular investment, nor does it involve any audit by the rating agency.”

CRAs are required to be registered by the SC for rating debt or *Sukuk* issues in Malaysia, pursuant to the “Guidelines on Registration of Credit Rating Agencies,” which was revised in March 2011. A CRA is also required to adopt the International Organization of Securities Commissions (IOSCO) CRA Code in its own code of conduct, and to disclose this on its website. Where the CRA’s code of conduct differs in substance from the provisions of the IOSCO CRA Code, the rating agency must explain where and why these differences exist, and fully disclose such explanation on its website.

In Malaysia, generally all debt securities and *Sukuk* issues are required to be accompanied by a credit rating at all times. A credit rating is a mechanism through which an independent third party, i.e. the CRA, makes an assessment on the likelihood of a corporate issuer's default on its debt repayments. A credit rating focuses on a specific debt instrument and not the overall creditworthiness or financial standing of the corporate issuer. A rating will take into consideration various enhancement tools like guarantees, sinking funds, letters of credit, or any other mechanism devised to reduce the default risk of specific issues.

Hence, the work of a CRA provides the benefits detailed in the next few paragraphs:

1. Information Disclosure

As the debt securities and *Sukuk* market develops and the nature and variety of debt instruments and *Sukuk* increase, even experienced investors may find it difficult to make informed choices because of lack of accessibility or the complexity of information about the corporate issuer. The nature and specialization of a CRA place it in a position where it has access to public as well as private information pertinent to the assessment of credit risk. Such information is not usually accessible to the individual investor. A competent CRA, therefore, bridges this information gap between the issuers of debt or *Sukuk* and investors. Conversely, markets that are inefficient will lead to incorrectly-priced securities, which do not reflect the fundamental values of the assets and, thus, lack information necessary to investors. In providing information on default risk, investors have access to information that enables them to establish benchmarks for comparing the risks and returns on their investments.

2. Investor Protection

The independent, objective analysis of the credit quality of debt and *Sukuk* issues aids the investor in making informed choices to determine the level of risk and associated returns they are willing to undertake for their investment.

Besides the predictive value of ratings, the continuous surveillance of a rated instrument acts as an early-warning system for investors on any changes in the quality of the rated debt or *Sukuk*, so that investors may reassess their positions and realign their portfolios accordingly.

3. Lower Cost of Borrowing

A high rating assigned to a corporate borrower translates into lower cost of borrowing for the issuer as the risk premium demanded by investors is lower. Corporate borrowers are thus motivated to improve their financial structures and operating risks to obtain high ratings for their private debt securities (PDS) or *Sukuk* issues. This, in turn, enables companies to raise more funds to finance their expansion and the management of their activities, resulting in higher allocative efficiency.

4. Aids Pricing Decisions

The interest payable on corporate debts and profit payments for *Sukuk* are linked to their assigned ratings. Therefore, credible and objective ratings are invaluable aids to investment bankers, underwriters and brokers when determining the pricing of debt instruments. To promote transparency in the debt securities and *Sukuk* market, information on ratings is widely disseminated to all existing and potential PDS and *Sukuk* investors in a timely manner.

Obligation to be Rated by a Recognised Rating Agency

Currently, all Malaysian ringgit corporate bonds are required to be rated by a rating agency registered by the SC. However, the SC exempts certain corporate bonds from being rated, such as those listed below:

- (i) Irredeemable convertible loan stocks.
- (ii) Foreign currency-denominated private debt securities.
- (iii) Convertible bonds or loan stocks and exchangeable bonds which fulfill the following requirements:
 - (a) Investors of bonds or loan stocks are given the right to convert or exchange the instruments into the underlying share at any time or within a reasonable period or periods during the tenure of the bond issue; and
 - (b) The underlying shares are listed on the stock exchange.
- (iv) Private debt securities:
 - (a) which are non-transferable and non-tradable;
 - (b) whose investors do not require a rating; and
 - (c) the principal adviser to ensure that both criteria above are met prior to the applicable issue, offer or invitation.

Please refer to Chapter 7.09 of the Private Debt Securities Guidelines for full details.

I. Financial Guarantee Institution

Financial guarantee institutions (FGIs) help raise the credit rating of bond issues, which otherwise would normally be below investment grade, to a level deemed as investment grade by investors by lending their own sterling ratings to these bond issues. Issuers will need to pay a premium, commensurate with the perceived risk of the issuer, to these FGIs who will undertake to pay the interest and capital repayment in the event that the issuer fails to do so.

Danajamin Nasional (Danajamin), Malaysia's first financial guarantee insurer, was established in May 2009 to provide financial guarantee insurance for bonds and *Sukuk* issuances, which enabled access to the PDS market to viable Malaysian companies. Jointly owned by the Minister of Finance Incorporated (50%) and the Credit Guarantee Corporation Malaysia (50%), Danajamin is rated AAA by both RAM and MARC. Danajamin have an issued and paid-up capital of MYR1 billion and another MYR1 billion callable capital. Its underwriting capacity is up to MYR15 billion.

This important initiative is also expected to help stimulate the local economy by guaranteeing bonds issued by companies in key sectors like infrastructure and services to finance viable projects.

J. Governing Laws on Bond Issuance

Under the governing law on bond issuances in Malaysia, all issuances of primary securities are governed under Sec. 212 (Part VI: Issues of Securities and Take-Overs and Mergers, Division 1, Proposals in Relation to Securities Proposals to be

submitted to Commission) of the CMSA with the exception of government bonds. Any person or entity dealing in government or corporate bonds is required to be licensed under CMSA.

Specific laws governing different types of bonds are summarized as follows:

1. Government Bonds

Government securities dealers are typically banking institutions licensed and regulated by BNM. Besides commercial banks and Islamic banks, investment banks are also participants in the inter-bank market for government securities.

The “Malaysian Code of Conduct for Principals and Brokers in the Wholesale Money and Foreign Exchange Markets,” issued by BNM, sets out best market practices, principles and standards to be observed in the Malaysian market. The objective is to uphold market integrity and promote the highest level of professionalism.

In addition, BNM also issues rules and guidelines governing the issuance, allotment, interest payment, redemption, and settlement of scripless securities under the Fully Automated System for Issuing/Tendering (FAST) and RENTAS. The aim of these guidelines is to provide a uniform set of rules to promote operational efficiency, market integrity and market transparency.

Detailed information on the rules and guidelines issued by BNM can be obtained from the FAST website.¹⁴

2. Corporate Bonds and *Sukuk*

The CMSA, which is administered by the SC, governs a substantial part of the activities in the domestic corporate debt securities and corporate *Sukuk* markets. On 1 July 2000, the SC became the single regulator for the Malaysian corporate debt securities and corporate *Sukuk* markets, and moved towards a full disclosure-based regulatory regime with the issuance of the Guidelines on the Offering of Private Debt Securities. This was followed by the issuance of the Guidelines on the Offering of Islamic Securities.

The SC issues guidelines on the issuance of corporate bonds and *Sukuk*, supervises trading activities in the secondary market, and conducts joint examinations and inspections of investment banks together with BNM. The SC’s guidelines and regulations relating to corporate bonds and *Sukuk* issuances represent part of the government’s initiatives to develop the debt securities and *Sukuk* market in Malaysia, by putting in place an efficient and facilitative issuance process. Towards this end, the regulatory framework for the issuance of corporate bonds and *Sukuk* has been developed with the following objectives:

- (i) To rationalize a fragmented regulatory structure;
- (ii) To expedite and create a facilitative and transparent approval scheme for corporate debt securities and corporate *Sukuk*;
- (iii) To impose greater disclosure requirements for better protection of corporate

¹⁴ Fully Automated System for Issuing/Tendering (FAST). <https://fast.bnm.gov.my/fastweb/public/MainPage.do>

- debt securities and corporate *Sukuk* investors, and to enhance legal protection afforded to these investors; and
- (iv) To enhance secondary market liquidity for corporate debt securities and corporate *Sukuk*.

Over the years, the SC has issued a comprehensive set of guidelines, regulations and practice notes to guide and clarify the requirements for all aspects of corporate debt securities and corporate *Sukuk* issues. A complete set of these guidelines, regulations and practice notes is available on the SC's website.¹⁵

K. Transfers of Interests in Bonds

Malaysian Government debt securities are scripless, thus securities transfer is electronic. In the RENTAS system operated by MyClear (a wholly-owned subsidiary of BNM), transfer instructions are done on a trade-by-trade basis, with the transfer of securities running simultaneous with the transfer of funds for payment.¹⁶

L. Definition of Securities

1. Securities

Securities are defined as:

- (i) **debentures**, stocks or bonds issued or proposed to be issued by any government;
- (ii) shares in, or debentures of, a body corporate or an unincorporated body; or
- (iii) unit trusts or prescribed investments, and includes any right, option or interest in respect thereof, but does not include futures contracts.¹⁷

2. Debentures

Debenture includes debenture stock, bonds, notes and any other evidence of indebtedness of a corporation for borrowed monies, whether or not constituting a charge on the assets of the corporation, but shall not be construed as applying to any of the following:

- (i) any instrument acknowledging or creating indebtedness for, or for money borrowed to defray the consideration payable under, a contract for sale or supply of goods, property or services, or any contract of hire in the ordinary course of business;
- (ii) a check, banker's draft or any other bill of exchange or a letter of credit;
- (iii) a banknote, guarantee or an insurance policy;
- (iv) a statement, passbook or other documents showing any balance in a current, deposit or savings account;

¹⁵ The complete guidelines regulations and practice notes are also available in the Securities Commission of Malaysia (SC) website. <http://www.sc.com.my>

¹⁶ More information is available on the Bank Negara Malaysia website. http://bondinfo.bnm.gov.my/portal/server.pt?open=514&objID=27257&parentname=CommunityPage&parentid=3&mode=2&in_hi_userid=22874&cached=true; http://bondinfo.bnm.gov.my/portal/server.pt?open=514&objID=27271&parentname=CommunityPage&parentid=4&mode=2&in_hi_userid=22874&cached=true

¹⁷ Government of Malaysia. *Capital Markets and Services Act 2007* (CMSA), sec. 2(1).

- (v) any agreement for a loan where the lender and borrower are signatories to the agreement and where the lending of money is in the ordinary course of business of the lender, and any promissory note issued under the terms of such an agreement; or
- (vi) any instrument, product, or class of instruments or products as the Minister of Finance may, on the recommendation of the SC, prescribe by order, published in the Gazette.

M. *Sukuk*

1. *Sukuk*

Malaysia has emerged as the largest Islamic securities, or *Sukuk*, market in the world, with MYR334 billion or 61% of all outstanding *Sukuk* worldwide originating from Malaysia as of September 2011. In its simplest form, *Sukuk* are certificates of equal value that represent an undivided interest (proportional to the investor's interest) in the ownership of an underlying asset (both tangible and intangible), usufruct, services, or investments in particular projects or special investment activities. Unlike conventional debt securities that mirror debts or loans on which interest is paid, *Sukuk* can be structured based on innovative applications of Islamic principles and concepts. Nonetheless, *Sukuk* share some similarities with conventional debt securities in that they are similarly structured based on the ability of the issuer to pay the periodic distribution and principal repayment.

2. The Legality of *Sukuk*

Sukuk represent ownership claims on a pool of assets, or rights to receivables or participation. The various transaction contracts that form the genesis for a *Sukuk* issue have different legal implications for investors. *Sukuk* investors should, therefore, be fully apprised and knowledgeable on their rights and obligations under the various Islamic concepts and principles.

c. Rights to Underlying Asset and Its Cashflow

For *Sukuk* that represent ownership of assets, their usufruct or services (the underlying asset), the claim embodied in the *Sukuk* is not just a claim on the underlying asset used in the *Sukuk* transaction, but also the right to the cash flow and proceeds from the sale of the asset. For example, in *Sukuk* Ijarah, the *Sukuk* are akin to trust certificates establishing undivided ownership of the leased asset and the right to the cashflow arising from it.

d. Rights to Cashflow from the Contract of Exchange but not the Asset

For *Sukuk* issued as evidence of indebtedness arising from the sale of asset based on contracts of exchange other than Ijarah, such as those originating from *bai' bithaman ajil*, *murabahah* and *istisna'*, the claim is on the obligations stemming from the applied contract of exchange, and not ownership of the physical asset, as ownership has been transferred to the obligor.

e. Rights to Undivided Interest in Specific Investments

For special investment activities funded through *musyarakah* (loss-sharing scheme) or *mudharabah*, the *Sukuk* represent the holders' undivided interests in the specific

investments. *Sukuk musyarakah* is used to raise funds for projects on the basis of partnership contracts. *Sukuk musyarakah* holders or investors then become the owners of the project, in proportion to their respective shares. Profits are distributed according to a pre-agreed proportion while losses are pro-rated according to their equity share.

Each *Sukuk mudharabah* holder or investor, on the other hand, holds equal value in the *mudharabah* equity. Profits will be shared on a pre-agreed ratio between the *mudharabah* investors and the *Sukuk* shared equally among the *mudharabah* investors.

N. Self-Governing Rules behind the Market

The following organizations support the market:

1. Bursa Malaysia

Bursa Malaysia is an exchange holding company approved under Sec. 15 of the CMSA. It operates a fully-integrated exchange, offering a complete range of exchange-related services including trading, clearing, settlement and depository services. Bursa Malaysia today is one of the largest bourses in Asia with just under 1,000 listed companies offering a wide range of investment choices to the world. Companies are either listed on Bursa Malaysia Securities Main Market or the ACE Market¹⁸.

Bursa Malaysia is guided by the following regulatory principles aimed at achieving regulatory goals and ensuring a consistent and cohesive approach to its actions and decisions. These principles are also embedded in the rules and regulatory framework of Bursa Malaysia. The regulatory principles will ensure greater parity of regulatory actions across the different segments of parties regulated and overall greater effectiveness in regulation. The regulatory principles are as follows:

- (a) Clear and easily accessible rules and requirements
- (b) No more regulation than necessary
 - (i) Balance competing needs of regulation and business efficacy; and
 - (ii) Ensure costs and burden of regulatory compliance are proportionate to the benefits.
- (c) Principle-based approach where appropriate

Bursa Malaysia works towards a principle-based approach to regulation where appropriate, but issue guidance where necessary.

- (d) Outcome focused
 - (i) Target outcomes through its regulatory actions or decisions rather than mere compliance with rules.
 - (ii) Use discretion to modify or waive the rules, where the spirit of the rules

¹⁸ Main market is the merging of main board and second board while the ACE market is a revamp of the MESDAQ Market. More details can be found in the Bursa Malaysia website: http://www.bursamalaysia.com/website/bm/listed_companies/main_ace_market.html.

- can still be achieved, business can be facilitated without harming other stakeholders, or where the burden of complying far outweighs the benefits.
- (iii) Always be guided by its regulatory objectives and the current regulatory concern.
- (iv) Consider the impact of its regulatory actions or decisions before and after taking each action or decision.

(e) Innovative and competitive

Facilitate innovation, for example, by avoiding unreasonable restrictions on regulatees

(f) Risk-based approach

- (i) Emphasize risk-based supervision rather than “one-size-fits-all” regulation
- (ii) Facilitate early detection of problems, issues and trends, enabling prompt pre-emptive actions

(g) Values-based approach

- (i) Enforce the rules without fear or favor
- (ii) Act professionally with integrity and fairness
- (iii) Exercise its powers and discretion consistently while also considering the particular facts of each case and different points of view
- (iv) Act swiftly in a proactive manner

(h) Transparency

- (i) Make regulatory approaches and processes more transparent
- (ii) Communicate clearly and effectively about what it does

(i) Benchmarked and globally collaborative

- (i) Observe and benchmark international standards and best practices
- (ii) Create and maintain close coordination among domestic and foreign regulators

(j) Consultative approach

- (i) Adopt a consultative approach and actively seek feedback from industry participants, other stakeholders, and the public
- (ii) Interact and leverage on relationships with stakeholders

Bursa Malaysia adopts a thematic approach to achieve its goals and objectives of ensuring effective market regulation. Under this approach, Bursa Malaysia will focus on certain key themes in discharging its regulatory role. These themes are regularly reviewed to ensure relevance in a progressive environment. The six themes are as follows:

- (i) Enhancing standards of corporate governance among listed issuers;
- (ii) Improving standards of disclosure;
- (iii) Promoting high standards of business conduct and self-regulation among brokers;
- (iv) Enhancing the effectiveness of enforcement;
- (v) Elevating the level of education and awareness in the industry; and
- (vi) Managing crisis in light of the global financial turmoil.

2. Financial Market Association of Malaysia

The Financial Markets Association of Malaysia (ACI Malaysia) was established in 1974 with the objective of providing an association for those who are actively engaged in the wholesale financial markets in Malaysia. Besides offering a platform for social and friendly contact among its members, ACI Malaysia is also actively involved in education to develop and enhance the knowledge and skills of its members. ACI Malaysia, whose membership comprises staff from treasury operations of Malaysia's financial institutions (including insurance companies), has adopted a code of conduct for the industry. It has five categories of membership: Provisional, Ordinary, International and Associate, and may invite any person to become an Honorary Member. In its effort to upgrade members' knowledge and skills, ACI Malaysia has, since December 1995, imposed qualifying examinations for its new members. Members must now pass the four modules of the ACI Certificate Examinations before they are licensed to participate in the financial markets. ACI Malaysia also organizes talks, seminars, conferences, meetings, and related gatherings for its members and the general public to improve and update their knowledge.

ACI Malaysia's key objectives are:¹⁹

- (i) Promote and develop any scheme which may elevate the status and/or advance the interests of the Association.
- (ii) Afford opportunities for social and friendly contact among members.
- (iii) Establish liaison with associations or bodies overseas having similar objectives, and to seek their assistance to participate in any seminar, forum, conference, meeting, or gathering organized by the association overseas.
- (iv) Organize talks, seminars, conferences, meetings and similar gatherings for members and for the public to improve and update their knowledge on the financial markets.
- (v) Educate, train and assess by examination or otherwise the members of the Association skilled financial markets, to award any certificate to those who successfully complete the examinations, and to award prizes to outstanding candidates in examinations.
- (vi) Establish and maintain libraries and collection of publications, research papers, papers delivered at seminars and conferences, and other documents and effects whether the same are in written form or otherwise.

The other main objective of ACI Malaysia is to constantly review the techniques and practices in the financial markets to develop, improve and maintain high standards comparable to international practices and techniques.

O. Investor Protection

1. Bondholders Rights

Bondholder rights are protected under the *Companies Act 1965* and *Capital Markets and Services Act 2007*, and in their various amendments. Under the Companies Act, creditors, including bondholders, can file a winding-up petition for a company when debtors are unable to pay their debts. When a winding-up order is made, the court appoints a liquidator who oversees the liquidation process.

¹⁹ Persatuan Pasaran Kewangan Malaysia. http://www.ppkm.net/v2/articles.php?article_id=2

Foreign creditors have the same rights as local creditors under Malaysian laws. Under the *Capital Markets and Services Act*, all bond issuers are required to enter into a trust deed with an appointed trustee. The trust deed contains bond provisions, covenants, and other requirements set by the SC. The trustee's role is to safeguard the interests of the bondholders as set out in the trust deed and in the *Capital Markets and Services Act*. Bond documents (e.g., prospectus, term sheets) also contain covenants and relevant default clauses specific to the bond issue that provide additional protection to bondholders. The SC's website provides copies of term sheets and/or principal terms and conditions of bond issuances.

2. Prevention of Fraud

The SC imposes laws on securities trading offenses such as false trading, manipulation and fraud which are liable to result in fines and imprisonment under Part V of the CMSA.

P. Trustees

Trustees for a bond or *Sukuk* issue have the responsibility of safeguarding the interests of bondholders. The trustee will, among others, vet through the transactions documents of a bond or *Sukuk* issue to ensure, to the best of its ability, the following:

That there are no inconsistencies or conflicts of interest between the provisions of the trust deed and the conditions stated in the SC's letter of approval, and in the term sheet approved by the SC;

That there are no provisions in any of the transaction documents that are inconsistent or in conflict with, or may lead to inconsistency or conflict with, the trustee's duties; and

That the SC's Guidelines on Trust Deeds (effective 12 August 2011) have been complied with.

In view of the important role of trustees in a debt securities or *Sukuk* issue, the SC has introduced a set of registration guidelines to ensure that only fit and proper trustee companies can act as bond or *Sukuk* trustees, and that they discharge their fiduciary duties in a proper manner. For this purpose, a bond or *Sukuk* trustee for an issue of debentures or Islamic securities approved by the SC on or after 2 January 2007 must be registered with the SC pursuant to the Registration by the Securities Commission for the Purpose of Acting as a Bond Trustee. The issuance of the registration criteria for trust companies to act as bond or *Sukuk* trustees dovetails with the requirement for a corporate bond or *Sukuk* issuer to appoint a trustee and enter into a trust deed under the CMSA.

The higher standards of professionalism among trustees will translate to greater protection for investors. Among others, the SC will evaluate the financial resources of the trustee company, its expertise, its independence and avoidance of conflict of interests, as well as track record to ensure that only fit and proper trustee companies

are registered. A list of companies registered with the SC to act as bond or *Sukuk* trustees are provided in the Appendix.²⁰

Generally all bonds and *Sukuk* are required to have a Trust Deed unless exempted under Schedule 8 of the CMSA.

Box 1.2 Exemptions from Need for Trust Deed (1)

SCHEDULE 8 (*1)

[Section 257(1)]

Debentures issues

Issues of, offers for subscription or purchase of, or invitations to subscribe for or purchase, debentures to which Subdivision 1 of Division 4 of Part VI and section 283 of Subdivision 2 of Division 4 of Part VI shall not apply.

1. An issue of, offer for subscription or purchase of, or invitation to subscribe for or purchase, debentures made by the Federal Government or any State Government or any statutory body.
2. An issue of, offer for subscription or purchase of, or invitation to subscribe for or purchase, debentures guaranteed by the Federal Government or Bank Negara.
3. An issue of, offer for subscription or purchase of, or invitation to subscribe for or purchase, debentures which by their terms may only be held by members of the issuer.
4. An issue of, offer for subscription or purchase of, or invitation to subscribe for or purchase, debentures which by their terms may only be held by a single holder of those debentures.
5. All trades in debentures effected on a stock market of a stock exchange which is approved by the Minister pursuant to subsection 8(2).
6. All trades in debentures effected in the money market.
7. An issue of, offer for subscription or purchase of, or invitation to subscribe for or purchase, debentures made pursuant to a scheme of arrangement or compromise under section 176 of the Companies Act 1965 or a restructuring scheme under the Pengurusan Danaharta Nasional Berhad Act 1998.
8. An issue of, offer for subscription or purchase of, or invitation to subscribe for or purchase, debentures made by or to Danamodal Nasional Bhd.
9. An issue of, offer for subscription or purchase of, or invitation to subscribe for or purchase, debentures made exclusively to persons outside Malaysia.
10. An issue of, offer for subscription or purchase of, or invitation to subscribe for or purchase, debentures to existing members of a company within the meaning of section 270 of the Companies Act 1965.
11. An issue, offer or invitation made in relation to a foreign currency denominated debenture to—
 - (a) an underwriter under an underwriting or initial purchase agreement;
 - (b) a unit trust scheme or prescribed investment scheme;
 - (c) a holder of a Capital Markets Services Licence who carries on the business of dealing in securities;
 - (d) a closed end fund approved by the Commission;
 - (e) a holder of a Capital Markets Services Licence who carries on the business of fund management;
 - (f) a corporation with total net assets exceeding ten million ringgit or its equivalent in foreign currencies based on the last audited accounts;
 - (g) a licensed offshore bank as defined under the Offshore Banking Act 1990; or
 - (h) an offshore insurer as defined under the Offshore Insurance Act 1990.
12. An issue of, offer for subscription or purchase of, or invitation to subscribe for or purchase, debentures or Islamic securities made by a multilateral development bank, a multilateral financial institution, a foreign sovereign or a corporation guaranteed or controlled by a foreign sovereign, with a credit rating of AAA or its equivalent, assigned by a credit rating agency.

Note: Emphasis added by the author.

Source: *Capital Markets and Services Act, 2007*, as amended.

²⁰ Please refer to the SC website for the complete list of registered Trustees. <http://www.sc.com.my/eng/html/resources/stats/RegisteredTrustees.pdf>

Box 1.3 Exemptions from Need for Trust Deed (2)**SCHEDULE 9 (*2)**

[Section 257(2)]

Debentures issues

Issues of, offers for subscription or purchase of, or invitations to subscribe for or purchase, debentures to which Subdivision 1 of Division 4 of Part VI and section 283 of Subdivision 2 of Division 4 of Part VI shall not apply.

1. An issue of, offer for subscription or purchase of, or invitation to subscribe for or purchase, debentures made by the Federal Government or any State Government or any statutory body.
2. An issue of, offer for subscription or purchase of, or invitation to subscribe for or purchase, debentures guaranteed by the Federal Government or Bank Negara.
3. An issue of, offer for subscription or purchase of, or invitation to subscribe for or purchase, debentures which by their terms may only be held by members of the issuer.
4. An issue of, offer for subscription or purchase of, or invitation to subscribe for or purchase, debentures which by their terms may only be held by a single holder of those debentures.
5. All trades in debentures effected on a stock market of a stock exchange which is approved by the Minister pursuant to subsection 8(2).
6. All trades in debentures effected in the money market.
7. An issue of, offer for subscription or purchase of, or invitation to subscribe for or purchase, debentures made pursuant to a scheme of arrangement or compromise under section 176 of the Companies Act 1965 or a restructuring scheme under the Pengurusan Danaharta Nasional Berhad Act 1998.
8. An issue of, offer for subscription or purchase of, or invitation to subscribe for or purchase, debentures made by or to Danamodal Nasional Bhd.
9. An issue of, offer for subscription or purchase of, or invitation to subscribe for or purchase, debentures made exclusively to persons outside Malaysia.
10. An issue of, offer for subscription or purchase of, or invitation to subscribe for or purchase, debentures to existing members of a company within the meaning of section 270 of the Companies Act 1965.
11. An issue, offer or invitation made in relation to a foreign currency denominated debenture to—
 - (a) an underwriter under an underwriting or initial purchase agreement;
 - (b) a unit trust scheme or prescribed investment scheme;
 - (c) a holder of a Capital Markets Services Licence who carries on the business of dealing in securities;
 - (d) a closed end fund approved by the Commission;
 - (e) a holder of a Capital Markets Services Licence who carries on the business of fund management;
 - (f) a corporation with total net assets exceeding ten million ringgit or its equivalent in foreign currencies based on the last audited accounts;
 - (g) a licensed offshore bank as defined under the Offshore Banking Act 1990; or
 - (h) an offshore insurer as defined under the Offshore Insurance Act 1990.
12. An issue of, offer for subscription or purchase of, or invitation to subscribe for or purchase, debentures or Islamic securities made by a multilateral development bank, a multilateral financial institution, a foreign sovereign or a corporation guaranteed or controlled by a foreign sovereign, with a credit rating of AAA or its equivalent, assigned by a credit rating agency.

Note: Emphasis added by the author.

Source: Capital Markets and Services Act, 2007, as amended.

Q. Meetings of Bondholders

The trustee is responsible for a resolution of a meeting of bondholders, where applicable. Meetings may be convened at the request of the issuer, trustee or an agreed percentage of debenture holders. Meetings of the bondholders are provided under clause 22 of the Guidelines on Trust Deeds (effective 12 August 2011), issued by the SC.

R. Bankruptcy Procedures

Malaysia's laws on bankruptcy have been established under the *Companies Act 1965*, *Bankruptcy Act 1967*, and in their respective rules and in various amendments.

The *Companies Act 1965* contains provisions for insolvency, rehabilitation, appointment of receivers, and winding-up procedures for companies. Specific laws governing industries may also have provisions governing insolvency of a company (e.g., the *Banking and Financial Institutions Act 1989* for banks). The *Bankruptcy Act 1967* covers bankruptcy laws for individuals.

The "Asia-Pacific Restructuring and Insolvency Guide 2006" provides an explanation on the restructuring and insolvency frameworks of Asia-Pacific countries, including the report on Malaysia.²¹

S. Event of Default

Events of default are usually negotiated terms but the Trust Deed Guidelines issued by the SC provides for the minimum contents requirements for such trust deed. The trust deed and the terms and conditions of debentures must provide for, but should not be limited to, the following:²²

- 1) A list of all events, the occurrence of any of which would entitle or oblige the trustee to declare the debentures immediately due and repayable (to the extent appropriate and subject to any materiality thresholds and provision for remedy or period of grace which may be negotiated) including the following:
 - (a) where there is any default in payment of any principal, premium or interest, or profit under the debentures or *Sukuk*;
 - (b) where a winding up order has been made against the issuer;
 - (c) where a resolution to wind up the issuer has been passed;
 - (d) where a scheme of arrangement under Sec. 176 of the *Companies Act 1965* has been instituted against the issuer;
 - (e) where a receiver has been appointed over the whole or a substantial part of the assets of the issuer;
 - (f) where there is a breach by the issuer of any term or condition in the debentures or *Sukuk*, or provision of the trust deed or of any other document relating to the issue, offer or invitation in respect of the debentures or *Sukuk*;

²¹ Asian Development Bank. 2006. *The Asia-Pacific Restructuring and Insolvency Guide 2006*. Malaysia: Shearn Delamore & Co. and PricewaterhouseCoopers. <http://www.adb.org/Documents/Guidelines/restructuring-insolvency/chap4-9.pdf>

²² Securities Commission of Malaysia. *Guidelines on the Minimum Contents Requirements for Trust Deeds*. Please refer to the latest trust deed guidelines issued in 2011, which was revised on 12 July 2011 and took effect on 12 August 2011. http://www.sc.com.my/eng/html/resources/guidelines/bondmkt/trustDeed_110812.pdf

- (g) where any other indebtedness of the issuer becomes due and payable prior to its stated maturity, or where the security created for any other indebtedness becomes enforceable; and
 - (h) where there is a revocation, withholding, invalidation or modification of a license, authorization or approval that impairs or prejudices the issuer's ability to comply with the terms and conditions of the debentures or *Sukuk*, or the provisions of the trust deed or any other document relating to the issue, offer or invitation in respect of the debentures or *Sukuk*.
- 2) The powers of the trustee in any of the events described in paragraph (1) include:
- (a) the powers of the trustee to declare the debentures or *Sukuk* immediately due and payable at its discretion;
 - (b) the powers of the trustee to declare the debentures or *Sukuk* immediately due and payable as directed by a special resolution;
 - (c) the powers of the trustee to enforce the provisions of the trust deed;
 - (d) the circumstances under which the trustee shall be bound to enforce the provisions of the trust deed; and
 - (e) the circumstances under which the holders of the debentures or *Sukuk* are entitled to pursue their rights and remedies.

Clause 12 of the Trust Deed Guidelines issued by the SC on August 2011 provides for events constituting default and the remedy of such default.

T. Currency of the Bonds

The most common currencies in which bonds are denominated are Malaysian ringgit and U.S. dollar. Foreign currency-denominated debt securities and *Sukuk* deposited in RENTAS may be settled in RENTAS on a delivery-versus-payment (DVP) basis.

U. Parties Involved in Bond Issue and Their Respective Roles

1. Lead Arranger or Principal Adviser

The role of the lead arranger or principal adviser is to structure the debt securities or *Sukuk* proposal, together with any other arrangers, and submit the application to the SC for approval.

According to the SC's Principal Adviser Guidelines issued on 8 May 2009, a principal adviser is the corporate finance adviser responsible for making submissions to the SC for corporate proposals. The categories of principal advisers and the types of corporate proposals they are permitted to submit to the SC are as follows:

Table 1.2 Categories of Principal Advisers and Permitted Types of Corporate Proposals

Items	Categories of Principal Advisers	Types of Corporate Proposals
a.	Investment banks/ licensed merchant banks/ universal brokers	All types of corporate proposals.
b.	1+1 brokers	All types of corporate proposals, except those involving private debt securities, Islamic securities and structured products.
c.	Special scheme brokers	<u>Issue of Structured Warrants</u> Proposals for the issue of structured warrants. <u>Offering of Foreign Securities</u> Proposals for the offering of equity securities, private debt securities, or Islamic securities of listed or unlisted foreign issuers to investors identified under Schedules 6 and 7 of the Capital Market and Services Act 2007.
d.	Islamic banks	All types of corporate proposals in respect of Islamic products.
e.	Licensed banks	<u>Offering of Private Debt Securities</u> All proposals for the offering of private debt securities, except for any of the following: - Private debt securities of Malaysian incorporated public companies or foreign corporations that are capable of being converted into equity; and - Private debt securities of Malaysian incorporated public companies or foreign corporations that are issued together with warrants. <u>Offering of Islamic Securities</u> All proposals for the offering of Islamic debt securities, except for any of the following: - Islamic securities of Malaysian incorporated public companies or foreign corporations that are capable of being converted into equity; and - Islamic securities of Malaysian incorporated public companies or foreign corporations that are issued together with warrants. <u>Offering of Structured Products</u> Proposals for the offering of structured products.
f.	Bank Pembangunan Malaysia	Proposals on infrastructure project companies for the purposes of listing such companies or otherwise.

Source: Securities Commission Malaysia. http://www.sc.com.my/eng/html/resources/guidelines/pa/gl_pa_090508.pdf

The guidelines on Principal Adviser can be found in Securities Commission website.

2. Adviser

Based on the Principal Adviser Guidelines issued by SC on 3 August 2009, a corporate finance adviser is defined as a person who is permitted to carry on the regulated activity of advising on corporate finance under the CMSA. The CMSA provides that any person carrying on the regulated activity of advising on corporate finance must either be a holder of a Capital Markets Services Licence (CMSL) or a registered person. In addition, the SC adopts a policy of permitting only certain categories of corporate finance advisers to submit applications to the SC in the capacity of principal advisers for certain types of corporate proposals under Part VI of the CMSA.

3. Underwriter

Investment banks and commercial banks are the main underwriters of debt securities and *Sukuk*. Underwriters assume the risk of undersubscribed debt issues and assure the issuer of liquidity.

The arranger of the issue, besides inviting licensed financial institutions to underwrite the issue, can also be an underwriter, depending on its limits and its appetite for the paper. If an issue is undersubscribed, the arranger will notify the underwriters. For issues of notes, underwriters bid at a discount, while for bond issues, bids are based on yield, depending on the coupon.

4. Facility Agent

The facility agent is responsible for all administrative matters pertaining to the issue, such as facilitating the creation of the issue and the stock code in FAST. The lead arranger, in many cases, also acts as the facility agent.

5. Paying Agent

The paying agent is responsible for the cash flow involved in the transaction, specifically in receiving the proceeds from the issuance on behalf of the issuer and remitting the proceeds to the issuer, as well as the payment of interest to investors. The lead arranger is often also the paying agent.

6. Legal Counsel

Before the finalization of a debt securities or *Sukuk* issue, a legal due diligence exercise is always conducted on the issuer, related projects and project information pertaining to the securities issue or *Sukuk*. This is done by a team of lawyers appointed by the issuer.

A limited financial due diligence exercise is also undertaken to ascertain the credibility of the financial projections and financial data of the issue. The primary purpose of these due diligence exercises is to ensure that no misleading and/or inaccurate information is furnished to the regulatory authorities and investors in general.

A set of guidelines on the standards expected from a due diligence exercise has been issued by the SC, i.e. the Guidelines on Due Diligence Conduct for Corporate Proposals, which came into effect on 1 February 2008.

7. Shariah Adviser

A Shariah adviser must be appointed for a *Sukuk* issue to advise the issuer on the appropriate and acceptable concept(s) and principle(s) to be used in the issuance. Shariah concepts and principles to be used must be approved by the Shariah Advisory Council.

The roles and responsibilities of Shariah advisers with regard to *Sukuk* issuance are set out in the Islamic Securities guidelines (*Sukuk* Guidelines).²³ In addition, the Registration of Shariah Advisers Guidelines (issued and effective on 10 August 2009) set out the general role and responsibilities, fit and properness, academic qualification, experience, and requirements for continuous professional development.²⁴ Refer to these two guidelines for details.

Section 316 of the CMSA contains specific provisions relating to the National Shariah Advisory Council. The Shariah Advisory Council (SAC) was established in 1996 primarily:

- a. To advise the SC on Shariah-related matters; and
- b. To provide Shariah guidance on Islamic Capital Market (ICM) transactions and activities, aimed at standardizing and harmonizing applications.

²³ Footnote 18. http://www.sc.com.my/eng/html/resources/guidelines/bondmkt/SukukGuidelines_110812.pdf

²⁴ Footnote 18. <http://www.sc.com.my/main.asp?pageid=970&menuid=&newsid=&linkid=&type=>

The main thrust of ICM products is compliance to Islamic principles.

8. Trustee

Trustees for a bond or *Sukuk* issue have the responsibility of safeguarding the interests of bondholders. The trustee will vet through the transactions documents of a bond or *Sukuk* issue to ensure the following:

- (i) That there are no inconsistencies or conflicts of interest between the provisions of the trust deed and the conditions stated in the SC's letter of approval, and in the term sheet approved by SC;
- (ii) That there are no provisions in any of the transaction documents that are inconsistent or in conflict with, or may lead to inconsistency or conflict with, the trustee's duties; and
- (iii) That the SC's Trust Deed Guidelines have been complied with.

Please refer to Chapter I. P. for more details.

9. Credit-Rating Agency

There are two credit-rating agencies (CRAs) in Malaysia that provide independent opinions on the credit risks and potential default risks of specific issuers. The first rating agency, Rating Agency Malaysia (now known as RAM Rating Services), was established in November 1990; the second, Malaysian Rating Corporation (MARC), was incorporated in October 1995.

The CRA performs the following functions:

- (i) Investor protection
- (ii) Enlarged investor pool
- (iii) Information disclosure
- (iv) Lower cost of borrowing
- (v) Aids pricing decisions

Please refer to Chapter I. H. for more details.

10. Financial Guarantee Institution

Financial guarantee institutions (FGIs) help raise the credit rating of bond issues, which otherwise would normally be below investment grade, to a level that investors deem as investment grade by lending their own sterling ratings to these bond issues.

Please refer to Chapter I. I for more details.

11. Bond Pricing Agency

Investors and issuers in the Malaysian debt securities and *Sukuk* market may obtain information on the prices of all ringgit-denominated bonds and *Sukuk* from a bond pricing agency. This is a private sector-led initiative, developed with the support of key bond market participants, to complement the government's objective of building more efficient, sophisticated and liquid bond and *Sukuk* markets. A bond pricing

agency must provide daily independent and objective fair values for all ringgit-denominated bonds and *Sukuk* (excluding irredeemable convertible unsecured loan stocks), which will also help facilitate daily mark-to-market valuation of bond and *Sukuk* portfolios. Any entity that wishes to carry out the business of providing bond and *Sukuk* prices must be registered with the SC pursuant to the Guidelines on the Registration of Bond Pricing Agencies, issued by the SC on 25 January 2006.

Bond Pricing Agency Malaysia (BPAM, formerly known as Bondweb Malaysia) is the country's first bond pricing agency to deliver pricing and information services exclusively on the ringgit bond and *Sukuk* markets. It currently provides daily evaluated prices for nearly 2,000 bonds and *Sukuk* in the domestic market, which is used by issuers, traders and investors alike.

BPAM has constructed a series of bond indices comprising Malaysian ringgit denominated, long-term, investment-grade conventional and Islamic securities. The TR-BPAM Bond Index Series (BPAM co-branded the index with Thomson Reuters in October 2011) will allow its users to pick and choose any index based on its principle, index type and tenure. As of 30 December 2011, the main index, TRBPAM All Bond Index, consisted of 793 bonds with a total market capitalization of MYR600 billion. The Index constituents undergo calculation, review and rebalancing on a daily basis. All return calculations are based on BPAM's mark-to-market prices.²⁵

V. Issuer

The central government of Malaysia issues bills and bonds that are facilitated by Bank Negara Malaysia (BNM). Central government bonds are issued to raise funds from the domestic capital market and for development expenditure. BNM also issues its own treasury bills and bonds for liquidity purposes.

Khazanah and Cagamas are the major issuers of quasi-government bonds. Financial institutions, non-financial institutions, and corporations issue private debt and asset-backed securities (ABS), commercial papers (CPs), and medium-term notes (MTNs) under conventional and Islamic principles.

1. Government

The federal government and BNM are the main issuers of public debt. Bonds are issued under conventional or Islamic principles.

2. Corporate

Financial institutions, non-financial institutions, corporations, and quasi-government institutions such as Khazanah and Cagamas issue private debt and ABS, CPs, and MTNs under conventional and Islamic principles. CPs and MTNs are short- and medium-term promissory notes used to finance short-term capital needs.

Corporate bond structures also vary in terms of coupons such as fixed- or floating-rate, step-up, zero coupons, and with warrants attached. CPs, MTNs and ABS are also issued by Malaysian corporations.

²⁵ Bond Pricing Agency Malaysia. <http://www.bpam.com.my>

3. Multilateral Development Banks

Multilateral development banks (MDBs) issue debt to finance long-term loans and very-long term development projects in their area of coverage.

W. Investor

Malaysian government securities (MGS) constitute the largest percentage of the bond market (about 33% of total outstanding bonds, as of the end of July 2011) and are primarily issued to the Employee Provident Fund (EPF) to meet its investment needs and to finance government expenditures. As of the end of March 2011, 58% of MGS holders comprise the EPF, insurance companies, and commercial banks while another 29% of MGS were held by foreign investors.

Government investment issues are bought mostly by banks dedicated to Islamic funds. The key investors for Malaysian Treasury bills are banks, finance companies, and insurance institutions. BNM is the largest shareholder of Cagamas bonds, which are also held by commercial banks, finance companies, and merchant banks.

1. Pension Fund

The Malaysian pension system comprises a series of provident funds. The EPF is the largest provident fund and accounts for over 85% of the total assets of the Malaysian provident fund system. It is a significant investor in the bond market and is required to invest 30% of its assets in MGS.²⁶

The Social Security Organization (SOCSO), which provides benefits to workers through the Employment Injury Insurance Scheme and the Invalidity Pension Scheme, invests at least 40% of its funds in government bonds or in bonds issued by government-linked organizations. The Pension Trust Fund, which was transformed into the Retirement Fund under the *Retirement Fund Act of 2007*, also invests considerable amounts in Malaysian government bonds and other types of fixed-income securities.

2. Insurance Companies

Private insurance companies dominate Malaysia's non-bank financial sector. Since the 1997–1998 Asian financial crisis, a merger program had reduced the number of insurers to 39 by the end of 2010.

The *takaful* sector is also experiencing rapid growth. *Takaful*, or mutual support, is the basis of the concept of insurance (solidarity) among Muslims where participants mutually agree to guarantee each other against defined loss or damage that may occur on any of them by donation from *takaful* funds. The number of *takaful* operators increased to nine by the end of 2010 from only three in 2003. The total *takaful* fund assets reached MYR14.7 billion by the end of 2010 from MYR4.4 billion in 2003.

3. Asset Management Institutions

SC began liberalizing Malaysia's unit trust industry in 1997. Since then, the investment management industry has expanded. SC reported that as of 31 December 2010, total funds managed by licensed fund management companies in Malaysia rose by 19.8% to MYR377.5 billion compared to MYR315 billion in 2009.

²⁶ For further information, please refer to the website of the Employees Provident Fund. <http://www.kwsp.gov.my/index.php?ch=p2about>

X. Authorized Depository Institution

To subscribe to or trade in debt securities and *Sukuk*, an investor must open an account with an authorized depository institution (ADI). ADIs are licensed financial institutions that are members of RENTAS and are allowed by Bank Negara Malaysia to hold Scripless Securities Depository System (SSDS) (previously known as Scripless Securities Trading System, or SSTS) securities on behalf of customers that are not members of SSDS. For members of the SSTS, BNM is the authorized depository, crediting bondholders with scripless bonds for trading and transfer according to the Code of Conduct and Market Practices for Scripless Trading, and recording the holdings and transactions of each SSTS member institution.

ADIs offer protection to investors with regard to payment of interest and redemption proceeds. They ensure secrecy of accounts, issue statutory acknowledgement receipts and monthly statements detailing account holdings and transfers, and carry out the various responsibilities of depository institutions for their customers.

Dealers that act as ADIs maintain two accounts with the SSTS: one for their own holdings, and another for all the securities they hold in custody, through which non-SSTS members' transactions are cleared and settled. ADIs are required to maintain a separate account for each customer.

Y. Quick Reference for Information on Cross-Border Issuance and Investment

Table 1.3 Quick Reference on Cross-Border Issuance and Investment in Malaysia

Description	Information
I. Issuance of Local Currency Bonds by Non-Resident	
• Local rating	Local currency bonds issued by Multilateral Development Banks, Multilateral Financial Institutions, Foreign Governments, and Agencies of Foreign Governments are given the option of obtaining local or foreign ratings.
• Local listing	Local currency bonds issued by a non-resident are not required to be listed.
• Governing law	Malaysian law
• Documentation language	English
• Time required to obtain approval	Securities Commission: Issue, offer or invitation of local currency bonds by Multilateral Development Banks and Multilateral Financial Institutions shall be deemed approved by the Securities Commission on the date of receipt of a complete submission. Other issuers, within 14 working days Bank Negara Malaysia: Within 7 working days upon receipt of full information
• Typical duration of issuance process	The duration of the issuance process can vary from issuer to issuer as the structure of the issue, economic conditions, etc. need to be taken into account
• Settlement organization for Government Bonds	Bank Negara Malaysia
• Settlement Organization for Unlisted Corporation	Bank Negara Malaysia
II. Investment in Local Currency Bonds	
By resident	
• Purchase	No restriction: • Payment to non-resident seller may be made in ringgit or foreign currency. • Payment to resident seller, however, must be in ringgit.

continued on next page

Table 1.3 continuation

Description	Information
• Sale	No restriction: <ul style="list-style-type: none"> • Receipt from non-resident buyer may be in ringgit or foreign currency. • Receipt from resident buyer must be in ringgit.
By non-resident	
• Purchase	No restriction: Payment to non-resident or resident issuer/seller may be made in ringgit or foreign currency.
• Sale	No restriction: Receipt from non-resident or resident buyer may be made in ringgit or foreign currency.
• Hedging onshore	Allowed with licensed onshore banks
• Hedging offshore	Allowed with the appointed overseas branches of the licensed onshore banks
III. Investment in Foreign Currency Bonds	
By resident	
• Purchase	<ul style="list-style-type: none"> • Resident corporates or individuals without domestic ringgit credit facilities: <ul style="list-style-type: none"> ✓ No restriction ✓ May finance through the conversion of ringgit or from foreign currency funds retained onshore or offshore • Resident corporates or individuals with domestic ringgit credit facilities: <ul style="list-style-type: none"> ✓ No restriction if financed with existing foreign currency funds ✓ Up to the following limits if financed with conversion of ringgit into foreign currency: <ul style="list-style-type: none"> ■ MYR50 million equivalent per calendar year by resident corporates on group basis ■ MYR1 million equivalent per calendar year by resident individuals • Resident unit trust management companies <ul style="list-style-type: none"> ✓ No limit on investment of Islamic funds ✓ 100% of net asset value (NAV) of foreign currency-denominated funds ✓ 100% of NAV of ringgit-denominated funds attributed to non-residents and residents without domestic ringgit borrowing; and ✓ 50% of NAV of ringgit-denominated funds attributed to residents with domestic ringgit borrowing • Resident fund or asset managers: <ul style="list-style-type: none"> ✓ No limit on funds mandated to be invested in Shariah-compliant assets ✓ No limit on foreign currency funds mandated to be invested in non-Shariah compliant assets ✓ No limit on ringgit funds of non-resident or resident without domestic borrowing mandated to be invested in non-Shariah compliant assets ✓ 50% of total ringgit funds managed for resident with domestic borrowing • Resident insurance companies and <i>takaful</i> operators: <ul style="list-style-type: none"> ✓ 100% of NAV of foreign currency-denominated investment-linked funds marketed to residents and non-residents ✓ 100% of NAV of ringgit-denominated investment-linked funds marketed to residents and non-residents without domestic borrowing ✓ 50% of NAV of ringgit-denominated investment-linked funds marketed to residents with domestic ringgit borrowing ✓ Up to 10% of total assets for insurers ✓ Up to 5% of total assets of the <i>takaful</i> operators
• Sale	No restriction: <ul style="list-style-type: none"> • Receipt from non-resident must in foreign currency • Receipt from resident may be in ringgit or foreign currency
• Hedging onshore	Allowed with licensed onshore banks
• Hedging offshore	Not allowed
By non-resident	
• Purchase	No restriction
• Sale	No restriction
• Hedging onshore	Allowed with licensed onshore banks
• Hedging offshore	No restriction

continued on next page

Table 1.3 continuation

Description	Information
IV. Financing to Non-Resident	
<ul style="list-style-type: none"> Local currency 	Freely allowed for the following: <ul style="list-style-type: none"> ✓ Non-resident (other than stock broking companies and banks) from licensed onshore banks, resident non-bank companies, and individuals to finance activities in the real sector in Malaysia ✓ Non-resident stock broking companies and banks from licensed onshore banks for settlement of ringgit instruments traded on Bursa Malaysia Berhad or through the Real-Time Electronic Transfer of Funds and Securities System (RENTAS) to avoid settlement failure due to inadvertent delays on the receipt of funds
<ul style="list-style-type: none"> Foreign currency 	<ul style="list-style-type: none"> No restriction from licensed onshore banks
V. Taxes	
<ul style="list-style-type: none"> Withholding 	No withholding tax on interest derived from the following: <ul style="list-style-type: none"> interest accruing to any resident or non-resident individual, unit trust and listed closed-end fund from: <ol style="list-style-type: none"> bonds or securities issued or guaranteed by the Government of Malaysia; debentures, other than convertible loan stock, approved by the Securities Commission; and Bon Simpanan Malaysia issued by Bank Negara Malaysia. Coupon/interest income derived by non-resident companies from: <ol style="list-style-type: none"> ringgit-denominated Islamic securities and debentures, other than convertible loan stocks, approved by the Securities Commission; and securities issued by the Government of Malaysia or Bank Negara Malaysia.
<ul style="list-style-type: none"> Capital gain 	No tax imposed
<ul style="list-style-type: none"> Other 	-
Other limitations on non-residents	Nil
VI. Settlement and Custodial Information for Local Currency Bonds	
<ul style="list-style-type: none"> Scripless trading 	Yes
<ul style="list-style-type: none"> Settlement cycles 	The standard settlement cycle is on T+2. However, the buyer and seller can specify a specific settlement date up to one (1) year forward.
<ul style="list-style-type: none"> International linkages 	Currently not available.
<ul style="list-style-type: none"> Custodian system 	<ul style="list-style-type: none"> The securities are issued in the form of Global Certificates (GC). The issuer lodges the GC with Bank Negara Malaysia as the Central Depository for safe custody. Bank Negara Malaysia will hold the GC on behalf of all securities holders and their scripless securities account for the purpose of trading and transfer. Investors maintain account with designated Authorized Depository Institutions (ADIs).
<ul style="list-style-type: none"> Real Time Gross Settlement System 	Yes, since July 1999. The system caters to the settlement for inter-bank funds transfer, as well as securities trades.
<ul style="list-style-type: none"> Delivery Versus Payment method 	Yes, settlement for unlisted securities trades is conducted based on a Delivery versus Payment (DVP) Model 1, i.e., where the settlement of securities and funds is conducted simultaneously on gross basis.
<ul style="list-style-type: none"> Others 	Nil
<p>^a Onshore licensed banks comprise all commercial banks and Islamic banks in Malaysia licensed under the Banking and Financial Institutions Act 1989 and the Islamic Banking Act 1983</p> <p>Source: AsianBondsOnline. Footnote 2. http://asianbondsonline.adb.org/malaysia/documents/quick_reference_my_march2006.pdf</p>	

II. Market Regulations in Malaysia

The Malaysian debt securities and *Sukuk* market is supervised by the Securities Commission (SC) and Bank Negara Malaysia (BNM). Both regulators play a dual role of supervising market intermediaries and the activities in the market, as well as actively supporting and developing the market infrastructure and fostering a conducive and facilitative environment. As a result of the coordinated and committed efforts of the SC and BNM, the Malaysian debt securities and *Sukuk* market has been charting stellar growth over the years.

A. Market Entry Requirements for Non-Residents

1. Foreign Issuers

Foreign issuers may issue bonds or *Sukuk* denominated in ringgit or foreign currency in Malaysia, subject to the approval of relevant authorities. The ringgit and foreign currency funds raised from such issuance may be used either in Malaysia or overseas. Nonetheless, the remittance of such funds overseas must be made in foreign currency other than the currency of Israel. There is no restriction for foreign issuers to open and maintain ringgit or foreign currency accounts with licensed onshore banks in Malaysia.

Foreign issuers may also manage their foreign exchange and interest or profit rate exposures arising from the bond or *Sukuk* issuance with licensed onshore banks or non-resident financial institutions. Nevertheless, all ringgit exposures shall be managed only with licensed onshore banks or appointed overseas branches of the banking group of the licensed onshore banks.

2. Foreign Investors

Foreign investors are free to invest in Malaysia in any form including the purchase of bonds or *Sukuk* denominated in ringgit or foreign currency by foreign issuers. There is no restriction for foreign investors to repatriate funds from divestment of ringgit assets or profits and dividends arising from the investments. However, repatriation must be made in foreign currency other than the currency of Israel.

Investment of ringgit assets by foreign investors may be funded from

- (i) foreign investors' own ringgit accounts (external accounts);
- (ii) sale of foreign currency with licensed onshore banks or appointed overseas branches of the banking group of the licensed onshore banks; or
- (iii) any amount of foreign-currency borrowing from licensed onshore banks and licensed international Islamic banks.

Details on foreign exchange administration rules can found in the BNM website.²⁷

B. Market Regulators

1. Bank Negara Malaysia

BNM (or the Bank) is the central bank of Malaysia. It was established on 26 January 1959 under the *Central Bank of Malaysia Act 1958* (CBA 1958), with its objectives extended under the new CBA 2009:

- (a) The principal objective of the Bank shall be to promote monetary stability and financial stability conducive to the sustainable growth of the Malaysian economy.
- (b) The primary functions of the Bank are as follows:
 - (i) to formulate and implement monetary policy in Malaysia;
 - (ii) to issue currency in Malaysia;
 - (iii) to regulate and supervise financial institutions which are subject to the laws enforced by the Bank;
 - (iv) to provide oversight over money and foreign exchange markets;
 - (v) to exercise oversight over payment systems;
 - (vi) to promote a sound, progressive and inclusive financial system;
 - (vii) to hold and manage the foreign reserves of Malaysia;
 - (viii) to promote an exchange rate regime consistent with the fundamentals of the economy; and
 - (ix) to act as financial adviser, banker, and financial agent of the government.
- (c) The Bank shall have all the powers necessary, incidental or ancillary to give effect to its objects and carry out its functions.
- (d) The Bank, in giving effect to its objects and carrying out its functions under this Act, shall have regard to the national interest.

Today, BNM focuses on the three pillars of central banking: monetary stability, financial stability, and the payment system. In addition, emphasis is given to the developmental role of BNM with respect to economic management, institution building, and the development of the financial system.

To enable BNM to meet its objectives, it has been vested with comprehensive legal powers under various acts to regulate and supervise the financial system. These acts include the *Central Bank of Malaysia Act 2009* (CBA 2009); the *Islamic Banking Act 1983*; the *Banking and Financial Institutions Act 1989* (or BAFIA); the *Takaful Act 1984*; the *Insurance Act 1996*; the *Development Financial Institutions Act 2002*; and the *Payment Systems Act 2003*. Collectively, these lay the legal foundation of and empower

²⁷ Bank Negara Malaysia (BNM). <http://www.bnm.gov.my/fxadmin>

the central bank to license and regulate institutions comprising banks, investment banks, money brokers, insurance companies, takaful operators, and development financial institutions, which constitute majority of the participants in the domestic debt securities and *Sukuk* market.

BNM is a statutory body wholly-owned by the Government of Malaysia with a paid-up capital currently at MYR100 million. The Bank reports to the Minister of Finance, Malaysia and keeps the Minister informed on matters pertaining to monetary and financial sector policies.

As the banker of and advisor to the government, BNM's role includes managing the liabilities of the government, both in Malaysia and abroad. It advises the government on its loan programs, including planning the auction calendar for government securities, taking into consideration the terms and timing of the loans and the types of securities. BNM participates actively in the monthly Cash Flow Committee meeting, chaired by the Treasury, to discuss the final details of government securities issuances. In addition, BNM is responsible for the issuance process, registration, settlement and redemption of government securities through the in-house automated trading and settlement system.

BNM is also empowered by several different laws to issue Malaysian government securities on behalf of the Government of Malaysia. Conventional debt instruments such as Malaysian government securities (MGS) and Malaysian Treasury bills (MTB) are issued under the *Loan (Local) Act 1959 (Revised-2004)* and the *Treasury Bills (Local) Act 1946 (Revised-1977)*, respectively. On the other hand, Islamic securities such as Government investment issues (GIIs) and Malaysian Islamic Treasury bills (MITBs) are issued under the *Government Funding Act 1983* (previously known as the *Government Investment Act 1983*). Each act sets a different issuance limit for conventional and Islamic instruments from time to time, by order of the Yang di-Pertuan Agong—the constitutional monarch of Malaysia—as published in the Gazette.

The *Treasury Bills (Local) Act 1946* empowers the Minister of Finance to borrow money through the issuance of treasury bills, while the *Loan (Local) Act 1959* authorizes BNM to raise funds within Malaysia, on behalf of the Minister, for the development fund. The *Government Funding Act 1983* provides for raising funds by the Government of Malaysia using instruments that adhere to Shariah principles, as approved by the National Shariah Advisory Council. This Act grants the Minister the authority to receive investments by creating and issuing instruments evidencing such investment, on behalf of the Government of Malaysia.

It is stipulated in the CBA 2009 that BNM can provide temporary advances, known as “ways and means” advances, to the government to cover any deficit in the budget revenue. However, there are legal limitations to the amount and the duration on loans that BNM can make available to the government.

Since 2005, BNM is allowed to purchase MGS from the primary and secondary markets based on market prices, and to use the purchased securities for its open market operations.

To ensure that these purchases do not unduly influence or distort market prices, BNM's participation in the primary auction is based on the weighted average price of the auction and is limited to a maximum of 10% of the issue size. Similarly, the amount purchased in the secondary market is limited to 10% of the outstanding issued amount. As of the end of September 2011, BNM holds 0.2% of the total MGS outstanding amount.

BNM had also been the regulator of the domestic corporate debt securities and corporate *Sukuk* market before it came under the purview of the SC in 2000. Today, the Bank continues to play a pivotal role in supporting the local debt securities and *Sukuk* market through its involvement in infrastructure development and the promotion of a facilitative foreign-exchange administration framework for foreign issuers and investors in the Malaysian market.

BNM is also the issuer of BNM monetary notes, which are issued to manage liquidity in both the conventional and Islamic financial markets. The Bank also conducts repurchase auctions as part of its open market operations. Among the major roles of the Bank is the prudent conduct of monetary policy, which has seen generally low and stable inflation for decades and thereby, preserving the purchasing power of the ringgit. The Bank is also responsible for bringing about stability in the financial system and fostering a sound and progressive financial sector. A well-diversified, comprehensive and resilient financial sector that is able to meet the increasingly sophisticated needs of consumers and businesses is now in place, which has become a growth driver in the economy.

The Bank also plays a significant developmental role, including the evolution of the financial system infrastructure with major emphasis placed on building the nation's efficient and secured payment systems, as well as the necessary institutions including the SC, Bursa Malaysia (formerly the Kuala Lumpur Stock Exchange, KLSE), and the Credit Guarantee Corporation, which are important towards building a comprehensive, robust and resilient financial system.

The Bank actively promotes financial inclusion, which has led to improved access to financial services for all economic sectors and segments of society, thereby supporting balanced economic growth.

2. Securities Commission Malaysia

The SC was established on 1 March 1993 under the *Securities Commission Act 1993* to promote and maintain fair, efficient, secure and transparent securities and futures markets, and to facilitate the orderly development of an innovative and competitive capital market. It is a self-funding statutory body with investigative and enforcement powers. It reports to the Minister of Finance and its accounts are tabled in Parliament annually. The SC's many regulatory functions include:

- (i) Supervising exchanges, clearing houses and central depositories;
- (ii) Registering authority for prospectuses of corporation other than unlisted recreational clubs;
- (iii) Approving authority for corporate bond issues;
- (iv) Regulating all matters relating to securities and futures contracts;
- (v) Regulating the takeover and mergers of companies;

- (vi) Regulating all matters relating to unit trust schemes;
- (vii) Licensing and supervising all licensed persons;
- (viii) Encouraging self-regulation; and
- (ix) Ensuring proper conduct of market institutions and licensed persons.

The SC administers the *Securities Industry Act 1983*, which governs a substantial part of activities in the domestic bond market. It also has the ultimate responsibility of investor protection. Apart from discharging its regulatory functions, the SC is also obliged by statute to encourage and promote the development of the securities and futures markets in Malaysia.

Prior to 1993, there was no single authority entrusted with the responsibility of regulating and systematically developing the Malaysian capital market. Supervisory powers were shared between industry organizations such as the stock exchange and government institutions. To streamline the regulatory structure of the capital markets, the SC was established as a self-funding statutory body with investigative and enforcement powers.

The SC's commitment to strengthening and broadening the domestic capital market is manifested in the Capital Market Masterplan (CMP). Launched in 2001, the CMP seeks to chart the future direction of the Malaysian capital market over the next 10 years. Twenty-two of the 152 recommendations in the CMP relate to developmental initiatives for the debt securities and *Sukuk* market.

3. Bursa Malaysia

Bursa Malaysia (formerly the KLSE) is now a holding company following demutualization in 2004. It is a self-regulatory organization that governs its members' conduct and member companies in securities dealings. It is also responsible for marketplace surveillance. Bursa Malaysia, on behalf of SC, supervises and enforces disclosure standards for listed companies.

4. Shariah Advisory Council

To ensure that all Islamic capital market products are in compliance with Shariah principles, the Shariah Advisory Council (SAC) was established in 1996 by the SC for the onshore market. The SAC comprises prominent Shariah scholars, jurists and market practitioners to advise the SC on matters relating to the Islamic capital market and provide Shariah guidance on Islamic capital market transactions and activities.²⁸

There are two SAC's in Malaysia: BNM's SAC and SC's SAC. The SAC is the highest and final authority on all Shariah matters concerning Islamic capital market products in Malaysia. The SAC of the SC has the mandate to make final decisions on Shariah matters concerning Islamic capital market products while the SAC of BNM has the mandate to make final decisions on Islamic banking products.

C. Related Regulations and Rules on Issuing Debt Instruments

1. Issuance by Government

BNM manages the liabilities of the government, both in Malaysia and abroad. It

²⁸ Please also refer to <http://www.sc.com.my/main.asp?pageid=251&menuid=277&newsid=&linkid=&type=>

advises the government on its loan programs, including planning the government securities auction calendar, taking into consideration the terms and timing of loans and issue of new types of securities. It participates in the monthly Cash Flow Committee meeting chaired by the Treasury to discuss the final details of government securities issuances.

BNM is responsible for trading, registering, settlement, and redemption of government securities through the in-house automated trading and settlement system. BNM and MyClear published the rules on RENTAS and FAST in PDF accessible in the public domain.²⁹

2. Issuance by Non-Residents

For foreign issuers, the Quick Reference for Information on Cross-Border Bond Issuance and Investment contains information on bond issuance by non-residents in Malaysia.³⁰

D. Rules and Regulations on Investment in Debt Securities

Currently, there are no specific regulations allowing non-high net-worth individuals (retail investors) to participate in the corporate bond market. Generally, dealers or other intermediaries require a minimum investment amount.

1. To increase trading efficiency, the SC liberalized the Central Depository System (CDS) account requirements in October 2005, widening the group of those allowed to hold securities on behalf of others. These exempt-authorized nominees are now allowed to hold securities in omnibus CDS accounts.
2. The SC has a special website for retail investors—the Malaysian Investor.³¹ The site provides helpful information on different securities, including bonds.

E. Taxation Framework and Tax Requirements

1. Interest Income Tax

Resident individuals, unit trust companies and listed closed-end fund companies are exempted from paying income tax for interest income earned from ringgit-denominated sovereign bonds, as well as private debt securities and *Sukuk* approved by the SC. Non-resident investors are also exempted from paying withholding tax on interest income and profit earned from ringgit-denominated debt securities issued by the Malaysian Government, as well as private debt securities or *Sukuk* approved by the SC. Meanwhile, resident investors are exempted from payment of income tax on the profits received from the foreign currency-denominated *Sukuk* issued in Malaysia. Profits or income from non-residents' investments in foreign currency-denominated *Sukuk* issued in Malaysia are fully exempted from withholding tax.

²⁹ Footnote 10. https://fast.bnm.gov.my/fastweb/public/files/RENTAS_Rules_May2006.pdf; https://fast.bnm.gov.my/fastweb/public/files/FAST_Rules_July2005_Update_15May2006.pdf; <http://www.myclear.org.my/index.php?id=53&mnu=53>

³⁰ Footnote 2. http://asianbondsonline.adb.org/malaysia/documents/quick_reference_my_march2006.pdf

³¹ The Malaysian Investor. <http://www.min.com.my/>

2. Stamp Duty

There is no stamp duty relating to the issuance and transfer of Malaysian Government securities (MGS), private debt securities or *Sukuk* approved by the SC.

3. Capital Gains Tax

There is no capital gains tax in Malaysia.

F. Tax Incentives

1. Tax Treatment for Issuers

- (a) Issuance for private debt securities (PDS) are exempted from stamp duty.
All instruments relating to the issuance and transfer of PDS approved by the SC are exempted from stamp duty effective 1 July 2000.
- (b) Tax deductions on expenses incurred in the issuance of *Sukuk*
Expenses incurred in the issuance of *Sukuk* will be tax-deductible until Year of Assessment 2010.
- (c) Exemption from stamp duty
All instruments for the purpose of securitization approved by the SC are exempted from stamp duty effective 1 January 2001. All instruments for the purpose of a *Sukuk* issuance approved by the SC are exempted from stamp duty.
- (d) Securitization exempted from real property gains tax
Real property gains tax in respect of chargeable gains accrued on the disposal of any chargeable assets to or in favor of a special purpose vehicle (SPV), or in connection with the repurchase of chargeable assets to or in favor of the person from whom the assets had been acquired, is exempted for the purpose of a securitization transaction.
- (e) Tax-neutral for the originator and SPV in a securitization
Tax-neutral framework in computing income-tax treatment for the originator and SPV involved in a securitization transaction is approved by the SC.
- (f) Extension of tax incentives for *Sukuk*
Extension of deduction on expenses for *Sukuk* issued under *musyarakah*, *mudharabah*, *Ijarah*, and *Istisna'* was allowed for another 3 years until the Year of Assessment 2010.
- (g) Tax deductions for SPV in a *Sukuk* transaction
Income-tax exemption is granted to an SPV established solely for issuance of *Sukuk*. A company establishing an SPV is given tax deduction on the SPV's cost of issuing Islamic securities effective 2007. SPVs set up for Islamic financing purposes are not required to comply with the administrative requirements under the *Income Tax Act 1967*.

- (h) Tax exemption from the Year of Assessment 2009 until the Year of Assessment 2011

Tax exemption from the Year of Assessment 2009 until 2011 is granted to a person licensed or registered under the CMSA in respect of income derived from dealing in *Sukuk* and advising on corporate finance relating to the arranging, underwriting, and distributing of *Sukuk* originating from Malaysia, and issued or guaranteed by the Government of Malaysia or approved by the SC.

2. Tax Treatment for Investors

- (a) Exemption on interest income from ringgit-denominated debt securities and *Sukuk*

Resident individuals, unit-trust companies, and listed closed-end fund companies are exempted from income tax on interest income and profits earned from ringgit-denominated sovereign bonds, as well as PDS and *Sukuk* approved by the SC. Non-resident investors are also exempted from paying withholding tax on interest income and profit earned from ringgit-denominated debt securities issued by the Malaysian Government, as well as PDS or *Sukuk* approved by the SC.

- (b) Exemption on interest income from foreign currency-denominated *Sukuk*
Resident investors are exempted from payment of income tax on the profits received from foreign currency-denominated *Sukuk* issued in Malaysia. Profits or income from non-residents' investments in foreign currency-denominated *Sukuk* issued in Malaysia are fully exempted from withholding tax.

- (c) No stamp duty on transfers of MGS, PDS and *Sukuk*
There is no stamp duty on the transfer of MGS, PDS or *Sukuk* approved by the SC.

- (d) Capital gains tax
There is no capital gains tax in Malaysia.

III. Trading of Bonds and Trading Market Infrastructure

The Malaysian bond market consists of listed and unlisted bonds. Unlisted bonds are largely traded over the counter (OTC) while listed bonds are traded through Bursa Malaysia.

A. Over-the-Counter Market Trading

In Malaysia's OTC market, the primary market segment is facilitated by Bank Negara Malaysia (BNM) through the Fully Automated System for Issuing/Tendering (FAST). It provides information on issue terms, real-time prices, completed trade details, and other relevant news about debt securities. FAST was first launched by BNM in September 1996 to automate the tendering procedure of government securities or Bank Negara Papers, which are issued through the principal dealer (PD) network. In July 1997, FAST was further enhanced to include commercial papers and medium-term notes, which are issued via tender or private placement.

In addition, Bursa Malaysia operates the Electronic Trading Platform (ETP), which facilitates the trading and reporting of secondary market activities. ETP acts as the centralized price and trade repository, and interfaces with FAST and information vendors. More information can be obtained through the Bursa Malaysia website.³²

B. Exchange trading

Bursa Malaysia is an exchange holding company approved under Sec. 15 of the Capital Markets and Services Act 2007 (CMSA). It operates a fully-integrated exchange, offering a complete range of exchange-related services including trading, clearing, settlement, and depository services. The wholly-owned subsidiaries of Bursa Malaysia own and operate these various businesses.

³² Footnote 8. <http://www.bursamalaysia.com/website/bm/trading/bonds/>

C. Bond Market Infrastructure Diagram

Figure 3.1 Bond Market Infrastructure Diagram (MY: T+2)

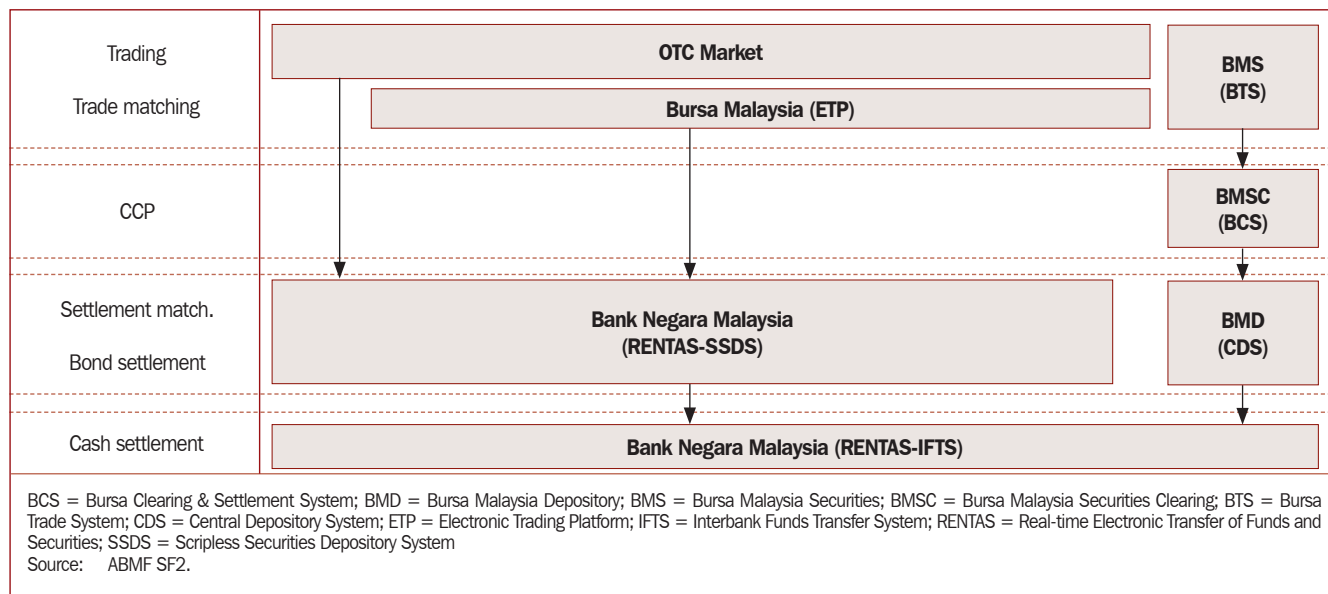

D. Business Process Flowchart: Bond Market (Over-the-Counter Market)/Delivery versus Payment

Figure 3.2 Business Process Flowchart: Over-the-Counter Market/Delivery versus Payment

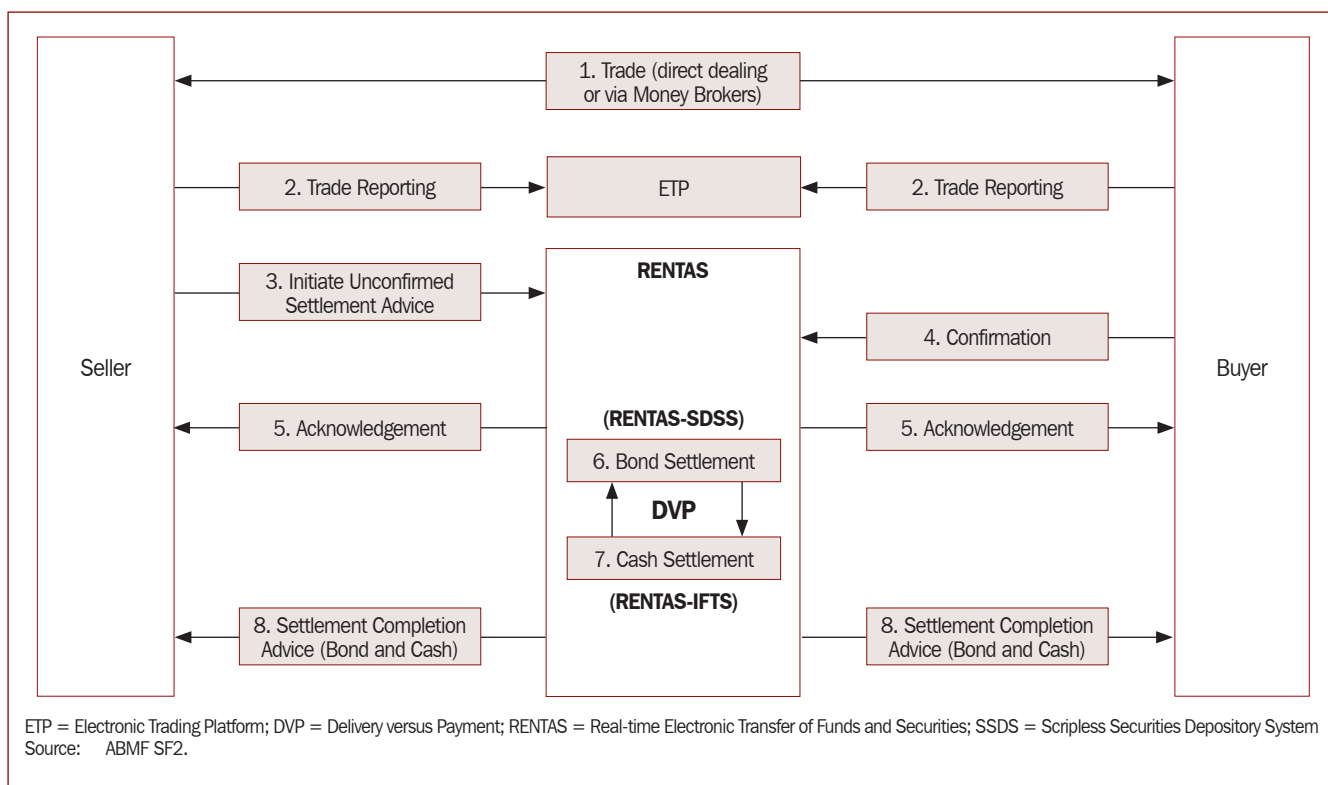

1. The seller and buyer trade over the counter by telephone (direct dealing or through money broker). Ninety-five percent of bond trades are dealt in the OTC market. Commercial banks and Islamic banks can trade the bonds.
2. All trades are recorded in the ETP.
3. The seller (or buyer) inputs trade data into Real-time Electronic Transfer of Funds and Securities (RENTAS) to initiate unconfirmed settlement advice.
4. The buyer (or seller) confirms an unconfirmed settlement advice using by the Confirmation menu of RENTAS.
5. The seller and buyer access the Report menu of RENTAS and confirm that confirmation of local matching is performed.
6. 7. On settlement date, bond and cash are settled on DVP basis.
8. The seller and buyer access Report menu of RENTAS and confirm report of Bond settlement and cash settlement.

E. Over-the-Counter Bond Transaction Flow for Foreign Investors

Figure 3.3 Over-the-Counter Bond Transaction Flow for Foreign Investors

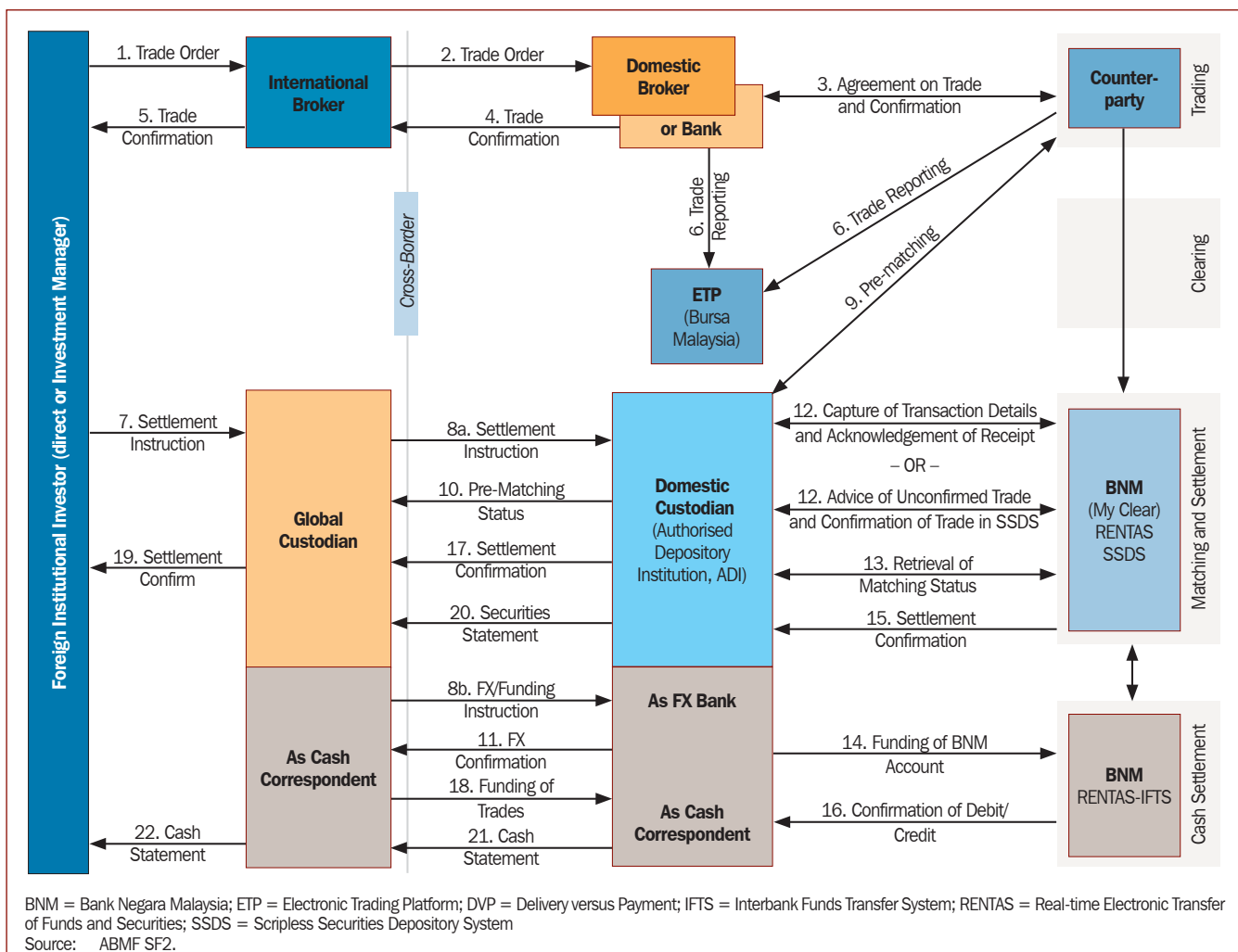

Trade Date

1. Foreign Institutional Investor places order with International Broker
2. International Broker or Domestic Investor places order with Domestic Broker/Bank
3. Domestic Broker or Bank and Counterparty agree on OTC trade (via e.g., phone or Bloomberg)
4. Domestic Broker or Bank sends trade confirmation to International Broker
5. Foreign Institutional Investor receives trade confirmation
6. Domestic Broker or Bank and Counterparty capture trade in ETP by end of trading day

T+1

7. Foreign Institutional Investor instructs Global Custodian, on securities settlement and cash and/or funding details
8. Global Custodian instructs Domestic Custodian/Authorized Depository Institution (ADI) on (a) securities settlement details, (b) foreign exchange (FX) request or funding details (since Third Party FX possible)
9. Domestic Custodian/ADI and Counterparty pre-match settlement details, via phone
10. Domestic Custodian/ADI sends pre-matching result information (e.g., missing instructions) to Global Custodian
11. Domestic Custodian/ADI provides confirmation of FX booked (in case of earlier FX request)

Settlement Date

12. Domestic Custodian/ADI captures settlement details into SSDS and receives SSDS acknowledgment of receipt of data (selling side), OR receives alleged trade notice (advice of unconfirmed trade) from Scripless Securities Depository System (SSDS) and confirms settlement details in SSDS (buying side)
13. Domestic Custodian/ADI retrieves settlement matching status
14. Domestic Custodian/ADI effects funding of its account at BNM via RENTAS (Interbank Funds Transfer System, IFTS)
15. Upon settling securities, SSDS sends settlement confirmation for securities to Domestic Custodian/ADI
16. Upon settling cash, RENTAS sends debit/credit confirmation to Domestic Custodian/ADI
17. Domestic Custodian/ADI sends settlement confirmation to Global Custodian
18. Global Custodian funds account with Domestic Custodian/ADI (before end of day)
19. Global Custodian sends settlement confirmation to Foreign Institutional Investor
20. Domestic Custodian/ADI sends statement of securities to Global Custodian (at end of day)
21. Domestic Custodian/Sub-registry sends debit/credit information in cash statement (at end of day)
22. Global Custodian sends debit/credit information in cash statement to FII (at end of day)

IV. Possible Items of Future Improvement

For possible items for future improvements of the Malaysian bond market, please refer to the comprehensive review of the Malaysia Capital Market Masterplan II in Chapter IX. Next Steps, which begins on page 71.

V. Description of the Securities Settlement System

A. Securities Settlement Infrastructure

Sovereign and unlisted corporate bonds are registered and settled through BNM's real-time gross-settlement, delivery-versus-payment system, RENTAS. RENTAS membership is restricted to financial institutions licensed under the Banking and Financial Institutions Act 1989 and includes Islamic banks, selected DFIs, non-banks such as EPF & KWA, International Central Securities Depositories and foreign central banks. All unlisted corporate bonds are held by BNM as a custodian agent and are settled by fund transfer.

All listed corporate bonds under the Bursa Malaysia are held in book-entry form and cleared and settled through the Bursa Malaysia Securities Clearing (formerly Securities Clearing Automated Network Services, SCANS). Bursa Malaysia also offers settlement services to institutional investors through the Institutional Settlement Service of Bursa Malaysia Securities Clearing.

The Bursa Malaysia Depository (formerly the Malaysian Central Depository) operates a system for the central handling of securities that facilitates securities transactions without the physical delivery of scrip. The Bursa Malaysia Derivatives Clearing (formerly the Malaysia Derivatives Clearing House) provides clearing and settlement services for the futures market operated by the Bursa Malaysia Derivatives (formerly the Malaysia Derivatives Exchange). The clearing and settlement of contracts executed under Bursa Malaysia's two exchanges (securities and derivatives exchanges) are based on the Fixed Delivery and Settlement System (FDSS). Settlement is on a T+3 basis. The financial settlement of securities is done on a net—rather than gross—basis.

F. Definition of Clearing and Settlement

1. Clearing

- (i) “Clearing” means the process of exchanging and reconciling payment items that result in the establishment of final positions for settlement.³³
- (ii) “Clearing facilities” refer to a facility for the clearing or settlement of transactions in securities traded on a stock exchange or futures contracts traded on a futures market; a facility for the guarantee of settlement of transactions; or such other clearing or settlement facility, or class of clearing or settlement facilities, as the Securities Commission (SC) with the approval of the Minister may allow.
- (iii) “Clearing house” means a person whose activities or objects include the provision of clearing facilities.
- (iv) The clearing house is the Bursa Malaysia Securities.

Rules of Bursa Malaysia Securities Clearing can be found in the Bursa Malaysia website.³⁴

2. Settlement

Settlement, in relation to a market contract, means the discharge of the rights and liabilities of the parties to the market contract whether by performance, compromise or otherwise; and includes partial settlement effected in accordance with the rules of an approved clearing house. All securities trades are generally settled on a delivery-versus-payment (DVP) basis. For all government and corporate debt securities deposited in RENTAS, ownership and transfers are reflected as book entries in the custody accounts with BNM in the RENTAS system. The settlement of primary and secondary market transactions in government securities and unlisted corporate debt securities takes place through the Scripless Securities Depository System (SSDS), which is part of the RENTAS system. US dollars-denominated debt securities and *Sukuks* may be settled in RENTAS on DvP basis while those denominated in other foreign currencies may be settled on a non-DvP basis.³⁵

³³ Bank Negara Malaysia, MyClear. 2011. *Participation and Operation Rules for Payments and Securities Services*. Kuala Lumpur.

³⁴ Footnote 8. http://www.bursamalaysia.com/website/bm/regulation/rules/bursa_rules/downloads/SCANSRules.pdf

³⁵ For a detailed description of the bond settlement process in the Malaysian market and the detailed transaction flow for transactions involving foreign institutional investors, kindly refer to Chapter III.D, page 46 in this document. More details can be found in the Bond Information Hub. <http://bondinfo.bnm.gov.my>

V. Costs and Charging Methods

The following market charges exist in the Malaysian market.

Table 5.1 Market Charges

Market Charge	Details
Brokerage Fees	Fully negotiable
Clearing Fees	To be determined by the Clearing House from time to time
System Maintenance Fees	To be determined by the Exchange from time to time
Source: Bursa Malaysia.	

Details on the market charges for listed bonds can be found on the Bursa Malaysia website.³⁶ For unlisted bonds, please refer to the Bond Information Hub website, which is maintained by BNM.³⁷

³⁶ Footnote 8. http://www.bursamalaysia.com/website/bm/regulation/rules/bursa_rules/downloads/bm_brchapter10.pdf.

³⁷ Bond Information Hub. <http://bondinfo.bnm.gov.my>

VI. Presence of *Sukuk* Market

A. *Sukuk* Market

The Malaysian *Sukuk* market has shown remarkable progress since its introduction in 1990. Malaysia has successfully created a niche market in this area. Based on the Islamic Finance Information Service, it is estimated that from January to September 2011, 70% of the total global Islamic bonds that have been issued were issued in Malaysia, making Malaysia one of the world's largest *Sukuk* market. In 2010, *Sukuk* issuance amounted to MR30 billion, accounting for 56% of total *Sukuk* issuance. In 2009 and 2010, *Sukuk* were extremely popular among issuers and investors alike, eclipsing conventional bonds and accounting in both years for more than 50% of issuance. Demand for Islamic paper by Islamic and conventional investors was strong, and major issuers, particularly toll road concessionaires and power supply companies, took advantage of lower issuance costs as the demand led to more competitive bidding.

B. Structure of *Sukuk*

A prerequisite for *Sukuk* is compliance with the Shariah (Islamic laws), which prohibits the charging of interest (*riba*). A *Sukuk* instrument is structured so that it involves an exchange of Shariah-compliant assets for financial consideration that allows investors to earn profits and rentals from transactions in the future.

There are various types of Islamic-based structures used for the creation of Islamic bonds. The more prominent ones are the sale and purchase of an asset based on deferred payment (*bai' bithaman ajil*), leasing of specific assets (*ijarah*), and a profit-and loss-sharing scheme (*musyarakah*). There are also a number of innovative instruments recently pioneered by market players involving the gamut of Islamic financial principles, including *istisna* (project finance), *murabahah* (cost-plus sale), *mudharabah* (profit-sharing), and *qard* (interest-free loan). In Malaysia, majority of *Sukuk* are debt-based instruments, i.e., *murabahah* and *bai' bithaman ajil*. As of end of October 2011, the proportion of corporate *Sukuk* approved based on various Shariah principles is as follows:

- (i) *Musharakah* 59%
- (ii) *Ijarah* 13%
- (iii) *Murabahah* 10%
- (iv) *Mudharabah* 9%
- (v) *Wakalah* 9%

Issuers are no longer constrained by the legal concept of debentures (debt-based), as required for conventional products, following the implementation of the latest *Sukuk* Guidelines made effective by the Securities Commission (SC) in August 2011.³⁸

C. Growth and Acceptance of *Sukuk*

The increasing popularity of Islamic bonds is attributable to several factors. First, *Sukuk* provide an avenue for Islamic-based investors who need to invest in Shariah-compliant instruments. Second, *Sukuk* have also appealed to conventional investors who are constantly looking for liquid, attractively priced instruments to obtain capital gains and income. The strong demand by investors also provides the opportunity to issuers to finance borrowing at a lower cost. Third, the Malaysian government has been actively involved in creating an efficient price-discovery process for Islamic securities through its issuance of Malaysian Islamic Treasury bills (MITBs) and government investment issues (GIIs), which has led to the establishment of an Islamic benchmark yield curve.

Over the years, Islamic capital market products have garnered universal acceptance as viable alternatives to conventional products. There has been clear evidence of the acceptability of the products to non-Muslim issuers and investors alike. As an indication of the success of Malaysia's Islamic capital market, 50% of funds raised in the private debt securities (PDS) market in 2010 were through Islamic products. The success of "mainstreaming" Islamic bonds could be replicated internationally, considering the estimated size of the global Islamic financial system and the latent demand for Shariah-compliant financial instruments.

D. Malaysia as an Islamic Capital Market Center

The Capital Market Masterplan (CMP) also provides a detailed long-term strategy to promote the Islamic capital market in line with Malaysia's core areas of competitive advantage. Recent measures by the authorities have facilitated cross-border issuance and investment of Islamic bonds, including:

- (i) allowing supranational and multinational corporations to issue Malaysian ringgit bonds;
- (ii) allowing investors to invest in foreign securities on exchanges recognized by Bursa Malaysia;

³⁸ Footnote 18. http://www.sc.com.my/eng/html/resources/guidelines/bondmkt/SukukGuidelines_110812.pdf

- (iii) allowing sophisticated investors to execute secondary trades in non-Malaysian ringgit bonds without SC approval; and
- (iv) liberalizing the framework for issuance of foreign currency-denominated bonds.

E. Regulatory Framework for Islamic Finance

Malaysia is at the forefront of Islamic finance. It is the largest issuer of Islamic financial products in the world. The SC supervises the Islamic capital market (ICM), which operates parallel to conventional capital markets. The ICM plays a complementary role to the Islamic banking system by broadening and deepening instruments and access to Islamic financial markets. Malaysia is also host to the Islamic Financial Services Board (IFSB).

F. Types of Instruments Available, Segments, and Tenure

Conventional government bonds have counterpart Islamic bonds (*Sukuk*). These are:

- (i) Bank Negara Monetary Notes-i (BNMNs-i) are Islamic securities issued by BNM to manage liquidity in the Islamic financial market, which replaced the Bank Negara Negotiable Notes.
- (ii) MITBs are short-term securities based on Islamic principles issued by BNM on behalf of the government. The structure of MITB is based on the *bai'al-inah* (sell-and-buy-back agreement) principle and are actively traded based on the *bai' ad-dayn* (debt trading) principle in the secondary market.
- (iii) GIIs are non-interest-bearing government securities based on Islamic principles issued by the government and placed on a competitive tender with 3- to 10-year maturities. Like Malaysian government securities (MGSs), GIIs are issued by BNM on behalf of the government, and the funds are used for development expenditures.
- (iv) *Sukuk* Bank Negara Malaysia issues (SBNMIs) are zero-coupon bonds with maturities of 1 to 2 years. SBNMIs are based on *al-ijarah* (sale and lease back) principle.
- (v) Merdeka savings bond is a bond structure based on Shariah principles with the purpose of assisting retirees who depend primarily on interest income from deposits placed with banking institutions.
- (vi) *Sukuk* 1Malaysia 2010, which is based on Shariah principles, is an additional investment instrument for Malaysian citizens who are 21 years and above. *Sukuk* 1Malaysia 2010 has a re-saleable feature that provides flexibility for investors to sell and purchase the *Sukuk* before maturity date.

Corporates also issue *Sukuk*. In fact, the corporate *Sukuk* market has grown exponentially in recent years, with an annual average growth of 21% between 2001 and 2008. Corporate *Sukuk* currently accounts for 55.9% of the outstanding corporate debt securities and *Sukuk* issued in Malaysia.

G. Basic Market Infrastructure Required to Facilitate Islamic Finance

The market infrastructure is the same for both conventional and Islamic securities.

H. Tax-Related Issues

Profits and dividends received by non-resident investors from holding of ringgit and non-ringgit Islamic instruments issued in Malaysia are exempted from withholding tax. Special purpose vehicles (SPVs) for Islamic financing purposes via the Islamic capital market are not subject to administrative procedures under the *Income Tax Act 1967*. In addition, companies that establish these SPVs are given tax deduction on the issuance cost of Islamic securities incurred by the SPV. The issuance costs for all Islamic securities approved by the SC are also eligible for tax deduction. Finally, there is a stamp duty exemption on instruments relating to Islamic securities under the Malaysia International Financial Centre (MIFC) until 2015.

VII. History of Debt Market Development

A. Market Development History

Table 7.1 Strategic Development Initiatives for the Malaysian Bond Market

Strategy	Initiatives
Introducing an efficient and facilitative issuance process	<ul style="list-style-type: none"> - Release of Guidelines on the Offering of PDSs - 2000 - Introduction of a shelf-registration scheme - 2000 - Release of Guidelines on the Offering of Asset-backed Securities (ABSs) - 2001 - Release of Asset Securitisation Report - 2002 - Introduction of Guidelines on the Offering of Islamic Securities - 2004
Establishing a reliable and efficient benchmark yield	<ul style="list-style-type: none"> - Introduction of an auction calendar for Malaysian Government Securities (MGS) - 2000 - Review of the principal dealers system
Widening the issuer and investor base	<ul style="list-style-type: none"> - Broadening of the investor base under the Securities Commission Act for the OTC market - Universal Brokers are allowed to trade in the OTC market - 2002 - ABSs are introduced together with tax-neutral framework and tax deductions on issuance expenses - 2003 - Islamic PDSs are accorded various tax incentives (eg., stamp duty waiver, tax deductions on issuance expenses) and a tax-neutral framework - 2003, 2005 - Multilateral development banks, multilateral financial institutions and multinational corporations are allowed to raise ringgit-denominated bonds - 2004 - Removal of withholding taxes on interest income earned on investments by nonresident companies in ringgit-denominated Islamic securities and securities issued by the Malaysian Government - 2004
Improving liquidity in the secondary market	<ul style="list-style-type: none"> - Non-financial institutions are allowed to enter into repurchase transactions - 2000 - The Securities Borrowing and Lending Programme is introduced via the RENTAS system - 2001 - Institutional Securities Custodian Programme (ISCAP) is put in place to encourage institutional investors to lend securities to BNM - 2004
Facilitating the introduction of risk management instruments	<ul style="list-style-type: none"> - Introduction of 3-, 5-, and 10-year MGS futures - 2002, 2003 - Introduction of Guidelines on Regulated Short-selling of Securities - 2005

Sources: Bank Negara Malaysia; Securities Commission.

During the 1970s and 1980s, the government issued Malaysian government securities (MGSs) to finance the public sector's development. Later, MGSs were issued to fund the fiscal deficit and refinance a portion of the government's external debt. Even in periods when fiscal surpluses were posted, the government continued to issue MGSs

to meet market demand. On the other hand, Shariah-based government investment issues (GIIs) and Malaysian Islamic Treasury bills (MITBs) were issued to provide liquid instruments that satisfy Islamic banks' statutory liquidity requirements.

Securitization in Malaysia began in 1986 when the government established the National Mortgage Corporation (Cagamas), the largest issuer of securitized instruments in Malaysia. Khazanah and Cagamas soon became major issuers of quasi-government bonds. Khazanah bonds were originally issued not to raise funds for capital or to finance projects, but for the specific purpose of serving as a benchmark for Islamic corporate bonds. Issuance of this original type of Khazanah bonds, however, has not occurred since 2006, and the outstanding amount of these bonds has fallen precipitously. More recently, Khazanah and Cagamas have been issuing corporate bonds and medium-term notes, both of which are classified as corporate instead of quasi-government bonds.

The growth of the debt securities and *Sukuk* market is also spurred further through the large issuance and growing interest in *Sukuk* which now forms an integral part of the Malaysian financial market. As a pioneer in the global *Sukuk* market, Malaysia has remained the largest issuer of *Sukuk*, with 62% of the world's outstanding *Sukuk* originating from Malaysia. Malaysia's lead is also reflected in the innovative and competitive structures that have been pioneered such as the exchangeable *Sukuk musharakah* and *Sukuk* based on *istisna'* and *ijarah*. The recent *Emas Sukuk* issuance by Petronas further reinforces Malaysia's position as the centre for *Sukuk* origination.

To ensure that access to financing through the financial market remains unhindered during the recent global financial turmoil, Bank Negara Malaysia (BNM) recently established Danajamin Nasional, a national financial guarantee insurer to provide credit enhancement for viable corporations to raise financing from the debt securities and *Sukuk* market. In addition, collaboration and coordination between the regulatory agencies are aimed at ensuring that the market remains resilient and robust against any shocks, and that stability is preserved.

Malaysia's bond market grew annually by 10.8% with outstanding debt securities tripling from MYR273.1 billion in 2000 to MYR758.6 billion in 2010. During this period, Malaysia emerged as a leading regional bond market with an average issue size of MYR670 million and an average weighted tenure of 16 years during 2000-2010. The development of a vibrant bond market was supported by a facilitative regulatory framework that streamlined the issuance process with the introduction of disclosure-based guidelines for private debt securities (PDS), asset-backed securities, structured products, and Islamic securities. Enhancements to the rating process, improved price transparency and a tax environment that attracted a wide range of issuers, including multilateral development banks, foreign multinational corporations, and foreign governments and agencies.

N. Regulatory Framework and Market Infrastructure Building

During the early years, BNM, the government agency responsible for corporate bond issuance, took several initiatives to strengthen the legal and regulatory framework

and market infrastructure of the underdeveloped primary and secondary markets. In March 1993, the Securities Commission (SC) was established to act as the single regulatory body to promote the development of the capital market, particularly to rationalize securities market regulations.

Prior to the establishment of the SC, a set of guidelines for PDS issuance was introduced in 1988. In addition, the Rating Agency Malaysia (RAM) and Malaysian Rating Corporation (MARC) were established in 1990 and 1995, respectively, to provide independent opinions on the potential default risk of debt issuers and disseminate all appropriate information to existing and potential investors in a timely fashion. The Bond Dealers Association was established in June 1996 to represent the industry's views and work with regulatory authorities to promote the bond market. The Financial Markets Association of Malaysia (ACI Malaysia) was established in 1974 to monitor, develop and improve industry standards, and to bring them in line with international best practice. ACI Malaysia, whose membership comprised staff from treasury operations of Malaysia's financial institutions, including insurance companies, had adopted a Code of Conduct for the industry. To qualify as a member of ACI Malaysia, a rigorous qualifying examination must be passed.

On the operational front, various processes were computerised and put online by BNM to enhance cost-effectiveness and efficiency. These included the introduction of the Fully Automated System for Tendering (FAST) in September 1996 to speed up securities tendering, and the Real-Time Gross Settlement System, Real-time Electronic Transfer of Funds and Securities (RENTAS), in July 1999 to reduce settlement risk. RENTAS was developed as a computerized scripless trading system to facilitate faster and more efficient trading, registration and settlement of securities.

The Bond Information and Dissemination System was introduced in October 1997 to facilitate efficient trading and promote transparency of information related to domestic debt securities. To further improve liquidity in the market, the Securities Borrowing and Lending Programme was introduced in December 2001 via the RENTAS system, and the Institutional Securities Custodian Programme was implemented in October 2004 to promote lending of securities to the central bank. For the Islamic bond market, an Internet-based platform system—the Islamic Interbank Money Market—was launched in September 2004 to provide transparency of information on Islamic financial products.

An important milestone in the broader bond market development agenda was the creation of the National Bond Market Committee (NBMC) in 1999. Its members comprised senior representatives from the Ministry of Finance, the Economic Planning Unit, BNM, SC, Bursa Malaysia, and the Registrar of Companies. Its purpose is to oversee the policy direction for the development of the bond market, and to identify and recommend appropriate implementation strategies. As a first step, the NBMC has authorized the SC to be the single regulatory body to regulate and promote the development of the corporate bond market.

To chart future growth, the Capital Market Masterplan (CMP1) was unveiled in 2001. A Capital Market Strategic Committee, consisting of high-level representatives from the SC and the private sector, was established in September 1999 to facilitate the

development of the capital market masterplan. CMP1 was the strategic blueprint for the Malaysian capital market over the next decade starting 2001, within which six broad objectives were spelled out:

- (i) to be the preferred fund-raising center for Malaysian companies;
- (ii) to promote an effective investment management industry and a more conducive environment for investors;
- (iii) to enhance the competitive position and efficiency of market institutions;
- (iv) to develop a strong and competitive environment for intermediation services;
- (v) to ensure a stronger and more facilitative regulatory regime; and
- (vi) to establish Malaysia as an international Islamic capital market center.

The CMP1 had been divided into three stages, spanning a period of 10 years and involving 152 detailed recommendations that seek to fulfil the realization of a robust and dynamic Malaysian capital market.

Table 7.2 Implementation Plan for the Capital Market Masterplan

Phase 1 (2001–2003)	Phase 2 (2004–2005)	Phase 3 (2006–2010)
Strengthen domestic capacity, and develop strategic and nascent sectors	Further strengthen key sectors and gradually liberalise market access	Further expansion and strengthening of market processes and infrastructure towards becoming a fully developed capital market, and enhancing international positioning in areas of comparative and competitive advantage
Source: The Securities Commission.		

Out of the 152 recommendations in the CMP1, by the end of June 2005, 96 recommendations (63%) had been put in place; 17 recommendations were made to enhance the Malaysian domestic bond market, particularly to establish a deeper, broader and more efficient corporate bond market. CMP1 initiatives were directed at key specific areas, and have included the enhancement of the fundraising process, ensuring the robustness and efficiency of the bond market microstructure and expanding both the issuer and investor base. With the essential building blocks in place, the development of the bond market proceeded at a steady pace towards the accomplishment of key goals, such as the establishment of a benchmark yield curve, improvement in secondary market liquidity, and the introduction of new asset classes to the market. Launched 10 years ago, CMP1 guided the development of the Malaysian capital market for the period of 2001 to 2010. It aimed to build a capital market that would be competitive in meeting the country's capital and investment needs and support long-term nation-building efforts.

Since 2000, the growth of the Malaysian capital market had outpaced the economy, with the size of the capital market expanding from MYR718 billion to MYR2 trillion, or at an annual compounded growth rate of 11%. This strong growth was achieved through rapid industry expansion and strong regulatory oversight that underpinned investor confidence in the capital market.

O. Regional Cooperation

The Malaysian domestic bond market has also benefited from regional cooperation in East Asia. Local and cross-border impediments have been addressed through the sharing of experiences and technical expertise, as each country has strived to add depth and breadth to its own domestic market. Three regional forums have been at the forefront of financial development in the region, namely the Asia- Pacific Economic Cooperation, the Association of Southeast Asian Nations Plus 3 (ASEAN+3) and the Executives' Meeting of East Asia and Pacific (EMEAP) Central Banks. These three forums focus on different aspects of local bond market development.

EMEAP's successful launch of the Asian Bond Fund I (ABF1), which pooled USD1 billion in reserves from 11 central banks and invested in US dollar-denominated bonds of sovereigns and quasi-sovereigns, led to the recent launch of the second fund, the Asian Bond Fund II (ABF2). The second fund involves the creation of local-currency bond funds in each EMEAP market, and consists of the Pan- Asian Bond Index Fund and eight single market funds. Launching these funds forced participating central banks to face market impediments head on, and address them as a group.

The listing of Malaysia's first exchange-traded fund (ETF), the ABF Malaysian Bond Index Fund, in July 2005 marked another important milestone in bond market development. The ETF was the second country sub-fund to be launched, following the successful listing of the ABF Hong Kong Bond Index Fund in June 2005. The fund consists of investments in government and quasi-government securities and tracks an index, which by design is replicable and transparent, paving the way for the introduction of other innovative products by the corporate sector in the future.

The listing of the ETF on Bursa Malaysia (the Malaysian Stock Exchange) should also generate interest on the part of domestic and international investors in the local bond market. Detailed information on the bond market development in Malaysia can be found at BNM's Bond Information Hub for Malaysian government securities and Securities Commission for corporate bonds.³⁹

³⁹ Footnote 33. <http://www.bondinfo.bnm.gov.my/portal/server.pt>; Footnote 18. <http://www.sc.com.my/main.asp?pageid=261&menuid=350&newsid=&linkid=&type=>

VIII. Market Size and Statistics

A. Market Size

Total outstanding local currency (LCY) bonds in Malaysia increased 16.5% year-on-year to MYR840 billion as of end of September 2011. Outstanding LCY government bonds jumped 19.8% year-on-year to MYR505 billion, mainly due to the increase in outstanding central bank bills. Excluding central bank bills, outstanding government LCY bonds rose by 10.9% year-on-year. LCY corporate bonds outstanding, on the other hand, posted 11.8% year-on-year growth to MYR335 billion. More information can be found at the AsianBondsOnline website.⁴⁰

B. Sukuk Market

Reflecting the government's effort to boost Malaysia's Islamic capital market, Islamic-based LCY government and corporate bonds outstanding have been steadily increasing for the past decade, amounting to MYR113.5 billion and MYR180.6 billion, respectively, at the end of 2010. Moreover, Islamic medium-term notes rose by 14.8% to reach MYR101.5 billion while the stock of more traditional Islamic bonds issued by corporations (IBONDS) declined to MYR68.8 billion. Islamic commercial paper rose to MYR5.3 billion in 2010 while Islamic asset-backed securities dropped to MYR5.1 billion. More information can be found at the AsianBondsOnline website.⁴¹

C. Equity Market

Market capitalization advanced strongly, crossing the MYR1-trillion threshold on the first trading day of 2010, and rounded off the year by growing by some 28% over the year. Initial public offering (IPO) activity contributed to a strong year-end boost in overall market values.

⁴⁰ Footnote 2.

⁴¹ Footnote 2.

D. Size of Local Currency Bond Market

Table 8.1 Size of Local Currency Bond Market in USD (Local Sources) (% GDP)

Date	Govt (in % GDP)	Corp (in % GDP)	Total (in % GDP)	Govt (\$ billions)	Corp (\$ billions)	Total (\$ billions)
Dec-00	38.0	35.2	73.3	35.68	33.02	68.71
Dec-01	43.1	41.1	84.2	39.94	38.16	78.10
Dec-02	44.0	34.2	78.2	44.36	34.47	78.82
Dec-03	48.4	36.6	85.0	53.33	40.38	93.71
Mar-04	46.1	33.8	79.9	52.19	38.18	90.37
Jun-04	45.0	32.1	77.1	52.66	37.47	90.13
Sep-04	46.1	31.5	77.6	55.89	38.11	94.01
Dec-04	46.1	31.5	77.6	57.51	39.27	96.78
Mar-05	46.2	30.8	77.0	58.99	39.39	98.38
Jun-05	45.8	31.4	77.2	59.74	40.95	100.69
Sep-05	45.2	31.7	76.9	61.11	42.81	103.92
Dec-05	44.4	33.0	77.4	61.34	45.63	106.96
Mar-06	44.1	32.9	77.0	64.24	48.01	112.25
Jun-06	44.5	32.8	77.3	66.76	49.21	115.97
Sep-06	44.1	32.5	76.6	67.55	49.70	117.24
Dec-06	43.6	33.0	76.6	71.02	53.67	124.68
Mar-07	47.1	32.7	79.8	79.47	55.09	134.55
Jun-07	50.9	34.6	85.5	87.91	59.67	147.58
Sep-07	52.6	34.3	86.9	94.62	61.66	156.28
Dec-07	48.9	35.9	84.8	94.90	69.61	164.51
Mar-08	51.0	35.0	86.0	107.50	73.80	181.30
Jun-08	50.0	35.9	85.9	108.41	77.79	186.20
Sep-08	44.9	35.2	80.2	96.89	75.92	172.82
Dec-08	42.1	35.5	77.6	90.19	75.92	166.11
Mar-09	44.5	36.3	80.7	88.12	71.87	160.00
Jun-09	48.7	39.0	87.7	96.36	77.08	173.44
Sep-09	51.9	41.4	93.2	100.72	80.32	181.03
Dec-09	51.0	42.4	93.4	101.23	84.17	185.40
Mar-10	51.3	40.5	91.8	110.99	87.54	198.53
Jun-10	55.0	40.4	95.3	123.97	91.04	215.00
Sep-10	56.3	40.0	96.4	136.55	97.08	233.63
Dec-10	58.2	40.4	98.6	145.44	101.11	246.55
Mar-11	60.0	39.7	99.6	155.81	103.14	258.95
Jun-11				160.58	108.38	268.96
Sep-11				158.35	105.04	263.39

Source: AsianBondsOnline. Footnote 2. http://asianbondsonline.adb.org/malaysia/data/bondmarket.php?code=LCY_in_GDP_Local

E. Size of Foreign Currency Bond Market in Percentage of Gross Domestic Product (Bank for International Settlement)

Table 8.2 Foreign Currency Bonds to Gross Domestic Product Ratio

Date	as % of GDP	FCY Denominated Bonds (\$ billions)	GDP (\$ billions)
Dec-95	7.8	6.8	87.6
Dec-96	9.3	9.4	100.5
Dec-97	16.4	11.9	72.7
Dec-98	15.4	11.5	74.5
Dec-99	17.2	13.6	79.2
Dec-00	15.9	14.9	93.8
Dec-01	17.3	16.1	92.8
Dec-02	21.7	21.9	100.9
Dec-03	19.1	21	110.2
Mar-04	18.6	21	113.1
Jun-04	17.9	20.9	116.9
Sep-04	18.5	22.4	121.1
Dec-04	18.5	23.1	124.7
Mar-05	18.1	23.2	127.7
Jun-05	18.3	23.8	130.4
Sep-05	18	24.3	135.1
Dec-05	17.1	23.6	138.2
Mar-06	17	24.8	145.7
Jun-06	16.4	24.6	150.1
Sep-06	16.6	25.4	153
Dec-06	15.7	25.6	162.9
Mar-07	15.1	25.5	168.7
Jun-07	14.1	24.4	172.7
Sep-07	13.5	24.4	179.8
Dec-07	12.7	24.6	193.9
Mar-08	12.2	25.7	210.9
Jun-08	11.9	25.7	216.8
Sep-08	11.9	25.6	215.6
Dec-08	11.6	24.9	214.1
Mar-09	12.2	24.3	198.2
Jun-09	10.9	21.5	197.8
Sep-09	13	25.3	194.2
Dec-09	12.3	24.5	198.4
Mar-10	11.5	24.9	216.3
Jun-10	11.7	26.3	225.5
Sep-10	11.4	27.7	242.5
Dec-10	11	27.5	250
Mar-11	10.7	27.7	259.9
Jun-11	10.4	27.9	268.1

Source: AsianBondsOnline. Footnote 2. http://asianbondsonline.adb.org/malaysia/data/bondmarket.php?code=FCY_in_GDP

F. Size of Foreign Currency Bond Market in US Dollars (Local Sources)

Table 8.3 Foreign Currency Bonds Outstanding (Local Sources)

Date	Government (\$ billions)	Banks and Financial Institutions (\$ billions)	Other Corporates (\$ billions)	Total FCY (\$ billions)
Mar-01	4.11	2.32	9.95	16.38
Jun-01	5.86	2.27	10.91	19.04
Sep-01	5.87	2.29	10.27	18.43
Dec-01	5.87	2.25	10.27	18.39
Mar-02	5.86	1.99	10.26	18.11
Jun-02	6.48	1.63	13.39	21.50
Sep-02	6.48	1.51	14.49	22.49
Dec-02	6.49	1.51	14.58	22.58
Mar-03	6.49	1.78	14.52	22.79
Jun-03	6.50	1.72	14.05	22.27
Sep-03	6.50	2.02	14.16	22.68
Dec-03	6.52	2.02	14.12	22.66
Mar-04	6.48	2.15	13.91	22.53
Jun-04	6.52	2.81	14.23	23.56
Sep-04	6.52	2.84	14.25	23.61
Dec-04	6.95	3.19	14.29	24.44
Mar-05	6.95	3.42	14.37	24.74
Jun-05	6.93	3.82	14.98	25.74
Sep-05	6.19	4.77	14.39	25.35
Dec-05	6.19	4.77	14.24	25.20
Mar-06	6.19	4.86	15.26	26.31
Jun-06	6.21	4.76	15.21	26.18
Sep-06	6.21	5.71	14.60	26.53
Dec-06	6.22	6.06	14.33	26.61
Mar-07	6.22	6.06	14.43	26.72
Jun-07	5.63	6.72	13.67	26.02
Sep-07	5.64	6.34	13.68	25.66
Dec-07	5.63	6.34	13.73	25.70
Mar-08	5.63	6.74	14.33	26.70
Jun-08	5.63	6.74	14.32	26.68
Sep-08	5.60	6.83	14.16	26.58
Dec-08	5.55	6.85	13.91	26.30
Mar-09	5.54	6.48	13.56	25.58
Jun-09	3.83	6.20	12.20	22.23
Sep-09	3.83	5.78	16.43	26.04
Dec-09	3.41	5.43	16.12	24.97
Mar-10	3.41	5.49	16.20	25.10
Jun-10	3.41	5.49	16.17	25.07
Sep-10	3.41	6.33	16.17	25.91
Dec-10	3.00	6.35	15.87	25.21
Mar-11	3.00	6.00	16.12	25.12

Source: AsianBondsOnline. Footnote 2. http://asianbondsonline.adb.org/malaysia/data/bondmarket.php?code=FCY_Bonds_Outstanding

G. Foreign Holdings in Local Currency Government Bonds

Table 8.4 Foreign Holdings in Local Currency Government Bonds (MYR billions)

Date	Foreign Holdings (MYR billions)	Total (MYR billions)	% of Total
Mar-96	2.11	69.27	3.05
Jun-96	2.11	70.45	3.00
Sep-96	2.11	70.96	2.97
Dec-96	1.71	71.06	2.41
Mar-97	1.71	69.06	2.47
Jun-97	1.74	67.34	2.59
Sep-97	1.80	67.34	2.67
Dec-97	1.74	69.01	2.52
Mar-98	1.67	68.56	2.44
Jun-98	1.67	69.16	2.41
Sep-98	0.62	69.01	0.89
Dec-98	0.60	77.01	0.77
Mar-99	0.67	76.86	0.87
Jun-99	0.70	78.86	0.88
Sep-99	0.39	78.34	0.49
Dec-99	0.39	80.34	0.48
Mar-00	0.20	83.24	0.24
Jun-00	0.22	89.24	0.24
Sep-00	0.23	91.29	0.25
Dec-00	0.23	93.05	0.25
Mar-01	0.23	96.75	0.24
Jun-01	0.15	96.45	0.16
Sep-01	0.18	101.45	0.18
Dec-01	0.23	107.45	0.21
Mar-02	0.22	105.05	0.21
Jun-02	0.13	107.55	0.12
Sep-02	0.15	109.55	0.13
Dec-02	0.19	114.55	0.16
Mar-03	0.11	123.35	0.09
Jun-03	0.15	129.85	0.12
Sep-03	0.12	135.30	0.09
Dec-03	0.12	137.80	0.09
Mar-04	1.22	143.30	0.85
Jun-04	1.14	147.20	0.78
Sep-04	1.51	155.95	0.97
Dec-04	7.58	163.45	4.63
Mar-05	10.31	169.45	6.08
Jun-05	13.04	169.95	7.67
Sep-05	10.49	175.50	5.98
Dec-05	7.95	176.15	4.51
Mar-06	9.09	180.75	5.03
Jun-06	11.34	188.95	6.00
Sep-06	14.34	192.75	7.44
Dec-06	14.63	193.90	7.54
Mar-07	17.56	202.60	8.67
Jun-07	22.96	213.00	10.78

continued on next page

Table 8.4 continuation

Date	Foreign Holdings (MYR billions)	Total (MYR billions)	% of Total
Sep-07	24.47	225.30	10.86
Dec-07	29.09	219.70	13.24
Mar-08	42.49	230.05	18.47
Jun-08	44.00	240.55	18.29
Sep-08	38.32	242.4	15.81
Dec-08	28.95	256.30	11.30
Mar-09	26.72	264.14	10.12
Jun-09	28.29	283.64	9.98
Sep-09	35.24	302.64	11.64
Dec-09	40.99	308.27	13.30
Mar-10	55.42	323.77	17.12
Jun-10	59.04	326.88	18.06
Sep-10	67.98	335.49	20.26
Dec-10	73.76	342.49	21.54
Mar-11	80.84	366.99	22.03
Jun-11	91.61	371.73	24.64

Source: AsianBondsOnline. Footnote 2. http://asianbondsonline.adb.org/malaysia/data/bondmarket.php?code=Foreign_Holdings

H. Domestic Financing Profile

Table 8.5 Domestic Financing Profile

Date	Domestic Credit (% of Total)	Bonds (% of Total)	Equity (% of Total)	Domestic Credit (\$ billions)	Bonds (\$ billions)	Equity (\$ billions)	Total (\$ billions)
Dec-00	0	37.78	62.22	0	68.70	113.16	181.86
Dec-01	40.82	23.45	35.73	135.94	78.10	118.98	333.02
Dec-02	41.80	22.74	35.46	144.87	78.83	122.89	346.60
Dec-03	37.70	22.92	39.38	154.12	93.71	160.97	408.80
Dec-04	36.36	22.12	41.52	159.04	96.78	181.62	437.44
Dec-05	37.05	23.42	39.53	169.22	106.97	180.52	456.70
Dec-06	34.99	22.50	42.51	193.87	124.69	235.58	554.14
Mar-07	32.72	21.94	45.34	200.70	134.56	278.04	613.31
Jun-07	30.48	22.57	46.95	199.24	147.58	306.96	653.78
Sep-07	32.11	23.55	44.34	213.03	156.28	294.21	663.52
Dec-07	30.98	23.18	45.84	219.86	164.51	325.29	709.66
Mar-08	33.31	25.66	41.02	235.33	181.30	289.81	706.44
Jun-08	33.96	26.97	39.06	234.47	186.20	269.67	690.34
Sep-08	37.91	27.52	34.57	238.05	172.81	217.04	627.90
Dec-08	40.92	27.62	31.46	246.14	166.11	189.24	601.49
Mar-09	41.01	27.67	31.31	237.11	159.99	181.03	578.13
Jun-09	38.2	26.52	35.28	249.78	173.44	230.71	653.93
Sep-09	37.07	25.80	37.14	260.16	181.03	260.62	701.80
Dec-09	36.49	24.81	38.70	272.65	185.40	289.22	747.27
Mar-10	35.88	24.44	39.68	291.38	198.53	322.27	812.18
Jun-10	35.74	25.84	38.42	297.33	215.00	319.68	832.01

continued on next page

Table 8.5 continuation

Date	Domestic Credit (% of Total)	Bonds (% of Total)	Equity (% of Total)	Domestic Credit (\$ billions)	Bonds (\$ billions)	Equity (\$ billions)	Total (\$ billions)
Sep-10	34.80	25.32	39.89	321.06	233.63	368.02	922.71
Dec-10	33.53	25.01	41.46	330.59	246.55	408.69	985.83
Mar-11	33.35	25.19	41.46	342.75	258.95	426.17	1,027.87
Jun-11	33.44	25.34	41.23	354.90	268.96	437.61	1,061.47

Source: AsianBondsOnline. Footnote 2. http://asianbondsonline.adb.org/malaysia/data/bondmarket.php?code=Domestic_Financing_profile

I. Trading Volume

Table 8.6 Trading Volume (\$ billions)

Year	Govt Bonds (\$ billions)	Corp Bonds (\$ billions)	Total (\$ billions)
Mar-04	12.51	15.04	27.55
Jun-04	13.58	14.93	28.51
Sep-04	23.09	13.18	36.27
Dec-04	18.67	11.39	30.06
Mar-05	21.66	9.57	31.23
Jun-05	24.12	8.26	32.38
Sep-05	26.18	6.59	32.77
Dec-05	19.51	7.42	26.93
Mar-06	22.71	6.51	29.22
Jun-06	25.51	5.11	30.62
Sep-06	34.63	7.72	42.35
Dec-06	33.68	10.76	44.44
Mar-07	47.34	8.99	56.33
Jun-07	52.81	9.70	62.51
Sep-07	50.80	6.33	57.13
Dec-07	43.90	7.75	51.65
Mar-08	66.43	6.95	73.38
Jun-08	73.91	7.23	81.14
Sep-08	69.45	3.54	72.99
Dec-08	51.99	3.87	55.86
Mar-09	50.45	3.26	53.71
Jun-09	55.25	4.56	59.81
Sep-09	59.21	5.40	64.61
Dec-09	56.55	4.74	61.29
Mar-10	66.11	5.88	71.99
Jun-10	79.22	8.75	87.97
Sep-10	86.10	6.97	93.07
Dec-10	85.87	6.89	92.76
Mar-11	113.55	6.80	120.35
Jun-11	137.77	8.63	146.40
Sep-11	167.48	9.07	176.55

Source: AsianBondsOnline. Footnote 2. http://asianbondsonline.adb.org/malaysia/data/bondmarket.php?code=Trading_Volume

IX. Next Step ⇒ Future Direction: Extract from the Capital Market Masterplan II⁴²

A. Growth Prospects to 2020

The Malaysian capital market has significant growth prospects. The Securities Commission (SC) estimates the size of Malaysia's capital market (comprising stock-market capitalization and debt securities) to more than double from MYR2.0 trillion in 2010 to MYR4.5 trillion by 2020.

The baseline forecast is predicated on annual real gross domestic product (GDP) growth of 6.5% and historical market benchmarks, and is subject to prevailing economic and market conditions. Overall, the long-range forecasts provide a reasonable reflection of baseline growth prospects based on extrapolation of historical trends. Further analysis indicates there are strong upside prospects for the Malaysian capital market. The structural reforms and high impact investment projects under the new economic model and economic transformation program (ETP) can accelerate economic growth momentum with a significant impact on the upside for the long-term growth of the capital market. Based on benchmarks for regional financial centers, it is estimated that internationalization of the stock market can increase the potential size of the Malaysian capital market by another 30% to MYR5.8 trillion in 2020. Higher levels of internationalization will also have positive growth effects on the bond market and the Islamic capital market (ICM). In addition, several segments are expected to achieve critical mass, such as ICM, which is projected to increase from MYR1.1 trillion in 2010 to MYR2.9 trillion in 2020, and the investment management industry where asset under management is projected to rise from MYR377.4 billion in 2010 to MYR1.6 trillion in 2020. The most important effect of achieving critical mass is the facilitation of volume strategies and higher efficiency from increased economies of scale.

Based on historical trends, the growth of the investment management industry is likely to outpace the growth of equity assets over this decade. This is a feature typical of an economy in transition from middle income to developed status. Projections indicate that the penetration rate for unit trusts is likely to almost double from 18% in 2010 to 34% in 2020, which is closer to levels usually seen in developed markets. The annual notional value of derivatives trading of MYR512.1 billion in 2010 is

⁴² Securities Commission. 2011. Capital Market Masterplan 2. <http://www.sc.com.my/main.asp?pageid=1044&menuid=1003&newsid=&linkid=&type=S>

currently largely based on crude palm oil futures contracts. There is substantial upside from further expansion of derivative products and this will deepen liquidity across market segments through positive spill-over effects from higher levels of inter-market trading, hedging and arbitrage.

With the core intermediation industries reasonably developed, the developmental focus will shift towards nurturing future growth segments, particularly in ancillary layers supporting intermediation activities. The development of more competitive niches will foster higher productivity and value-added activities with the supporting clusters providing positive growth feedback effects. Overall, the Capital Market Masterplan II (CMP2) offers a broad set of strategies that are aimed at addressing key structural challenges and critical linkages to create an environment conducive to private sector intermediation and expanding the growth boundaries of the capital market. These will be complemented with strategies to ensure effective governance arrangements to sustain confidence in the integrity of Malaysia's capital market and to maintain strong regulatory oversight to safeguard the interests of investors.

B. Widen Access to the Bond Market

The development of a significant bond market provided critical long-term financing to many large-sized and catalytic economic projects. This resulted in Malaysia having one of the best infrastructures in the region, ranging from international airports and highways to power plants and telecommunications. The bond market has also been a source of financing support for banks and corporations, and provided liquidity to balance sheets through the securitization of mortgages and other receivables.

In tandem with the economic transformation plans, there is a need to broaden the capability and capacity of the bond market to supply financing to a wider base of industries and projects, particularly in supporting the structural shift towards the services and knowledge-based industries. The ability to widen access to bond financing for more sophisticated ventures is critically dependent on broadening the investor base and appetite for a wider array of debt products and credit risks. Widening the credit spectrum therefore requires strengthening investor confidence, increasing the participation of the public and private investment management industry, expanding product range, and enhancing market infrastructure. Towards this end, market standards and practices will be enhanced through improving documentation and disclosure standards, as well as clarifying post-issuance disclosure obligations and requirements.

The credit rating agency (CRA) framework will be further enhanced to converge with new international standards and best practices covering key areas such as the transparency of rating criteria and policies, rating reviews and the governance structure of CRAs. The default process for bonds will also be reviewed to provide greater clarity and certainty to investors. In tandem with this, efforts will be made to promote a more active market for the pricing of distressed issues.

The participation of the public and private sector investment management industry in fixed-income investments needs to be further strengthened. This will require building their fixed-income investment capabilities to enable their participation

in a broader spectrum of structures and credits. There is also a need to increase transparency and liquidity in the secondary market to match the growth in primary issuance. This will be achieved through strengthening the environment for electronic trading and infrastructure in the areas of bond lending, market-making, trading, clearing, settlement and custodian services. Efforts will also be made to promote greater retail participation in the bond market through developing a framework to facilitate the offering of corporate bonds to retail investors that covers the eligible issuer base, mode of offering, format of offering documents, price transparency, investor protection and education activities. In addition, distribution channels will also be widened to enable greater retail investment.

The availability of a broad range of interest rate-sensitive products is required for the application of sophisticated fixed-income investment strategies and to promote active trading and arbitrage in the bond market. In conjunction with increasing institutional investment in fixed income, the product range will be broadened to include fixed-income indices and inflation-linked products.

Further additional mechanisms will be considered to widen participation and deepen liquidity in the bond market. The establishment of Danajamin Nasional provides a means for less-established companies to gain access to the bond market and to establish their track record for credit-worthiness while a review will be undertaken to assess the viability of establishing facilities to mitigate illiquidity risks of bond funds.

C. Growth Prospects for Bond Market to 2020

Malaysia's bond market is relatively well-developed with outstanding bond issuances approximating 97% of GDP. It is ranked the third largest bond market in Asia by GDP. Market depth is reflected by an average weighted bond tenure of 16 years and an average issuance size of MYR670 million, while market width is reflected by the diversified range of conventional and Islamic instruments.

The bond market is expected to sustain reasonable growth over this decade. The ETP has already identified several major infrastructure projects which will underpin strong domestic issuance. Demand growth will be driven by the increasing participation of the investment management industry in fixed-income investments and through growing international participation in Malaysia's bond and *Sukuk* market. Further improvements in the legal, regulatory and institutional framework will support the continued deepening and broadening of the bond market. The growing pool of fixed-income professionals will provide the necessary expertise to originate debt and *Sukuk* structures to match the financing requirements for infrastructure projects and the investment needs of both the private and public sectors.

D. Expand International Intermediation Capabilities

Malaysia has also strengthened the positioning of its bond market with the removal of withholding tax coupled with a facilitative approval framework. These developments have resulted in Malaysia being recognized as an important hub for cross-border investments and issuances in the region. Since 2004, foreign issuers have issued

MYR18.6 billion worth of bonds and *Sukuk*. Foreign investments in local currency bonds amounted to MYR121 billion in 2010. Overall, further improvements will be made to enhance the connectivity of the clearing and settlement infrastructure while friction costs will be reduced to attract more active international investor trading in the secondary equity, bond, and derivative markets.

The changing pattern of global savings intermediation augurs strong growth prospects for domestic intermediaries based in Asia. Asian intermediaries benefit from home ground advantage in recycling substantial domestic savings surpluses and from their proximity to new growth opportunities. In recognition of the benefits of higher intra-regional participation, the ASEAN Finance Ministers endorsed an Implementation Plan from securities regulators to promote the development of an integrated capital market in ASEAN by 2015. The Implementation Plan offers a comprehensive set of strategic initiatives and specific actions to pursue regional integration. This includes mutual recognition frameworks for cross-border offerings, listings, and professionals, the formation of exchange alliances, and the development of a regulatory framework and infrastructure conducive to facilitating cross-border transactions among capital markets in the region.

Domestic intermediaries have already been preparing to operate in a more open and competitive environment. They have strengthened their presence in the regional market and advised on international transactions. They have also embarked on distribution of international products to domestic clients (Box 9.1).

Box 9.1 Securities Commission Survey on International Expansion Plans of Intermediaries

In 2009, the SC conducted a survey of 89 capital market intermediaries on their international expansion plans over the next 10 years. The survey results are highlighted below:

- Ninety-four percent (94%) of domestic intermediaries anticipate expanding business abroad through establishing strategic alliances, subsidiaries, and through acquisition of foreign entities;
- The share of profits from international operations is expected to grow from less than 10% of total profits to between 30% and 50% over 10 years; and
- Domestic intermediaries expect their sales of foreign products to rise from 10% currently to about 30% of revenues.

Source: Securities Commission Malaysia, Capital Market Masterplan 2, p. 46 (<http://www.sc.com.my/eng/html/cmp2/separated/contents.pdf>)

The SC will continue to pursue cross-border regulatory arrangements to facilitate the expansion of domestic intermediaries and distribution of products in other markets. In addition, intermediary standards and capabilities will be strengthened across a broad range of industry segments to facilitate their participation in international transactions and markets.

Apart from its core industry segments, Malaysia has natural strengths in many parts of the value chain for capital market transactions. Internationalization will be an important catalyst to unlock hub opportunities in a broad range of middle- and back-office functions covering advisory services, research, risk management, compliance,

settlement, custodian, trustee and other services. In this regard, Malaysia is well-positioned to attract international participants as it offers an attractive choice of locations in Kuala Lumpur, Labuan and Iskandar, each with its own advantages. This needs to be complemented with strategies to attract talent with knowledge of international practices related to the capital market, law, accounting, tax and Shariah to build an ecosystem that provides cost-effective support for the structuring and processing of international capital market transactions.

E. Group of 30 Compliance

The so-called Group of 30 (G-30) Recommendations were originally conceived as the G-30's Standards on Securities Settlement Systems in 1989, detailing in a first of its kind report nine recommendations for efficient and effective securities markets covering legal, structural and settlement process areas. The recommendations were subsequently reviewed and updated in 2001, under the leadership of the Bank for International Settlements, and through the efforts of a Joint Task Force of the Committee on Payment and Settlement Systems and the Technical Committee of the International Organisation of Securities Commissions. Compliance with the G-30 Recommendations in individual markets is often an integral part in securities industry participants' and intermediaries' due diligence process.

Table 9.1 Group of Thirty Compliance

Recommendation		Implemented
1	Eliminate paper and automate communication, data capture, and enrichment.	Yes All unlisted debt securities are dematerialized, except for some CP/MTN programs issued before April 2006.
2	Harmonize messaging standards and communication protocols.	No CSD and most local market participants do not use SWIFT message formats.
3	Develop and implement reference data standards.	Yes ISIN codes are available for all local bond issues, and are available at the time of issue.
4	Synchronize timing between different clearing and settlement systems and associated payment and foreign exchange systems.	Yes
5	Automate and standardize institutional trade matching.	Yes
6	Expand the use of central counterparties.	No
7	Permit securities lending and borrowing to expedite settlement.	–
8	Automate and standardize asset servicing processes, including corporate actions, tax relief arrangements, and restrictions on foreign ownership.	–
9	Ensure the financial integrity of providers of clearing and settlement services.	Yes
10	Reinforce the risk management practices of users of clearing and settlement service providers.	Yes
11	Ensure final, simultaneous transfer and availability of assets.	Yes
12	Ensure effective business continuity and disaster recovery planning.	Yes

continued on next page

Table 9.1 continuation

Recommendation		Implemented
13	Address the possibility of failure of a systematically important institution.	Yes
14	Strengthen assessment of the enforceability of contracts.	Yes
15	Advance legal certainty over rights to securities, cash, or collateral.	Yes
16	Recognize and support improved valuation methodologies and closeout netting arrangements.	Yes
17	Ensure appointment of appropriately experienced and senior board members (of the boards of securities clearing and settlement infrastructure providers).	Yes
18	Promote fair access to securities clearing and settlement networks.	Yes
19	Ensure equitable and effective attention to stakeholder interests.	Yes
20	Encourage consistent regulation and oversight of securities clearing and settlement service providers.	Yes

CP = commercial paper; CSD = Central Securities Depository; ISIN = International Securities Identification Number; MTN = medium-term note; SWIFT = Society for Worldwide Interbank Financial Telecommunication
Source: Group of 30 (G30). 2003. *Global Clearing and Settlement – A Plan of Action*. <http://www.partad.ru/wrd/word/g30app1.pdf>

F. Group of Experts Barrier Report Market Assessment – Malaysia (April/2010)

The Group of Experts (GoE) Report refers to the published results in 2010 of the GoE formed under Task Force 4 of the Asian Bond Market Initiative (ABMI). In the report, published under the leadership of the Asian Development Bank (ADB), a group of securities market experts from the private and public sectors in ASEAN+3, as well as International Experts, assessed the ASEAN+3 securities markets on potential market barriers, the costs for cross-border bond transactions, and the feasibility of the establishment of a Regional Settlement Intermediary (RSI). The findings in the GoE Report led to the creation of the ASEAN+3 Bond Market Forum (ABMF).

Table 9.2 Barrier Report Market Assessment for Malaysia

Potential Barrier Area	Current situation	Market Assessment Questionnaire Scores	Overall Barrier Assessment
Quotas	There are no quotas on foreign involvement in the local market.	OK	OK
Investor registration	There is no requirement for foreign investor registration. There were comments from some investors regarding account-opening, identification of beneficial owner and other issues. It is believed these reflect restrictions introduced 10 years ago and which have now largely been repealed. The general feedback was that Malaysia was now an investor-friendly market with few difficulties.	OK	OK
FX controls - conversion	There are no restrictions on the purchase of MYR by non resident investors, provided the FX is executed with a licensed onshore bank. In this case, MYR may be freely bought and sold (or held) without evidence of underlying securities trades. Third-party FX is possible, but not common. Perception gap - there appears to be a perception among many investors that FX controls are more onerous.	LOW	OK
FX controls - repatriation of funds	There are no restrictions on repatriation of capital, profits and income. Foreign investors can freely remit funds from their local cash accounts. MYR can be freely sold for FCY.	OK	OK

continued on next page

Table 9.2 continuation

Potential Barrier Area	Current situation	Market Assessment Questionnaire Scores	Overall Barrier Assessment
Cash controls - credit balances	Clean cash payments between different beneficial owners are not prohibited. However, they are subject to “Permitted Reasons for Transfers” as prescribed under ECM4, Exchange Control Notices of Malaysia	LOW	OK
Cash controls - overdrafts	Overdrafts for non-resident accounts are limited. Overdraft facilities are only permitted for financing funding gaps due to unforeseen or inadvertent technical or administration errors, and funds must be repaid within 2 business days. Licensed onshore banks may extend any amount of ringgit overdraft facilities to non-resident stock-broking companies and custodian banks for settlement of ringgit securities on Bursa Malaysia and RENTAS due to inadvertent delays on receipt of funds from non-resident investors. This area was the one most often singled out by investors as a problem.	LOW	LOW
Taxes	There is no withholding tax for non-resident investors on interest on government bonds and on approved corporate bonds. However, there is a 15% tax on convertible loan stock interest. There is no capital gains tax in Malaysia.	OK	OK
Omnibus accounts	There are no restrictions on the use of omnibus accounts for non-resident investors.	OK	OK
Settlement cycle	The settlement cycle for listed bonds is T+3 and for unlisted bonds is negotiable (market practice is T+2).	OK	OK
Message formats	The CSD, and most local market participants, do not use SWIFT message formats.	LOW	LOW
Securities numbering	ISIN codes are available for all local bond issues, and are available at the time of issue. Most local market participants use ISIN codes in securities messages, but the CSD does not.	LOW	OK
Matching	There is an electronic platform for trade matching. Settlement pre-matching for bonds is carried out by telephone.	OK	OK
Dematerialisation	All unlisted debt securities are dematerialised, except for some CP / MTN programmes issued before April 2006.	OK	OK
Regulatory framework	Investor comments on the regulatory regime were generally favourable. There are, however, still memories of the controls introduced 10 years ago.	–	OK

CP = commercial paper; CSD = Central Securities Depository; FCY = foreign currency; FX = foreign currency; ISIN = International Securities Identification Number; MTN = medium-term note; MYR = Malaysian ringgit; RENTAS = Real-time Electronic Transfer of Funds and Securities; SWIFT = Society for Worldwide Interbank Financial Telecommunication
Source: ABMI Group of Experts (GoE) Report for Task Force 4, April 2010, Asian Development Bank. [https://wpqr1.adb.org/LotusQuickr/asean3goe/Main.nsf/h_58E34A1388F9070B48257729000C0A4E/90F408746827C16248257729000C1334/\\$file/Part3.pdf](https://wpqr1.adb.org/LotusQuickr/asean3goe/Main.nsf/h_58E34A1388F9070B48257729000C0A4E/90F408746827C16248257729000C1334/$file/Part3.pdf)

Appendixes

Appendix 1.1 Extracts from the Capital Markets and Services Act 2007 (CMSA)⁴³

A. PART VI: ISSUES OF SECURITIES AND TAKE-OVERS AND MERGERS

Box A1.1 DIVISION 1: Proposals in Relation to Securities Proposals to be submitted to Commission Section 212

212. (1) In this Division and Schedule 5, unless the context otherwise requires—

“an applicant” means any person referred to in subsection (2);

“expert” includes engineer, valuer, accountant and any other person whose profession gives authority to a statement made by him;

“officer”, in relation to a corporation, includes—

- (a) a director, a secretary, an executive officer or an employee of the corporation;
- (b) a receiver and manager, appointed under a power contained in any instrument, of any part of the undertaking or property of the corporation; and
- (c) a liquidator of the corporation appointed in a voluntary winding up of the corporation, but does not include a receiver who is not also a manager, a receiver and manager appointed by a court and a liquidator appointed by a court;

“private company” and “public company” have the meanings assigned to them in subsection 4(1) of the Companies Act 1965;

“proposal” means a proposal referred to in subsection (2).

(2) This section applies to a person who proposes to do any of the following:

- (a) make available, offer for subscription or purchase, or issue an invitation to subscribe for or purchase securities in Malaysia;
- (b) make available, offer for subscription or purchase, or issue an invitation to subscribe for or purchase, outside Malaysia, securities of a public company, or to list such securities on a securities exchange outside Malaysia;
- (c) by way of issue of securities, effect—
 - (i) a compromise or arrangement whether or not for the purposes of or in connection with a scheme, compromise or arrangement for the amalgamation of any two or more corporations or for reconstruction of any corporation; or
 - (ii) an acquisition of securities or assets;
- (d) apply for the listing of a corporation, or for the quotation of securities, on a stock market of a stock exchange;
- (e) distribute the assets of a public company or a listed corporation to its members other than distribution in cash or distribution of assets to members of the public company or listed corporation on its winding up; or
- (f) acquire or dispose assets (whether or not by way of issue of securities) which results in a significant change in the business direction or policy of a listed corporation.

continued on next page

⁴³ Footnote 13. A. Part VI: Issues of Securities and Take-Overs and Mergers. <http://www.sc.com.my/eng/html/cmsa/cmsa2007/cmsa2007.pdf>

Box A1.1 continuation

- (3) An applicant shall submit to the Commission such documents and such other information in relation to the proposal in such form and manner and at such times as the Commission may require.
- (4) Subject to section 213, no person referred to in subsection (2) shall implement or carry out a proposal unless the Commission has approved the proposal under this section.
- (5) The Commission may—
- (a) approve a proposal subject to such terms and conditions as it thinks fit;
 - (b) approve a proposal with such revisions and subject to such terms and conditions as it thinks fit; or
 - (c) reject a proposal.
- (6) A person who contravenes any term or condition in relation to an approval given under paragraph (5)(a) or (b) commits an offence.
- (7) Where the Commission is satisfied that—
- (a) there is a contravention of subsection 214(1);
 - (b) there is a breach of any term or condition imposed under paragraph (5)(a) or (b); or
 - (c) there is any change or development in the circumstances relating to a proposal occurring subsequent to the Commission giving its approval under subsection (5), and if such change or development, if known to the Commission prior to the approval, would have affected its decision as regards the proposal, the Commission may—
- (A) revoke an approval given under subsection (5);
 - (B) revise an approval; or
 - (C) impose such further terms or conditions in relation to a proposal approved by it under subsection (5):
Provided that the Commission may only revoke or revise such approval or impose such further terms and conditions where such revocation, revision or imposition shall not affect the rights of third parties that may have been created by or arising from the carrying out or implementation of a proposal in accordance with an approval given under subsection (5).
- (8) The Commission shall give a written notice to an applicant of its intention to take action under subsection (7) and shall give the applicant an opportunity to be heard prior to it taking any action under subsection (7).
- (9) Where the Commission has granted its approval to a proposal under subsection (5)—
- (a) if registration of a prospectus is required under this Act in connection with the proposal, the prospectus shall include a statement that the Commission has approved the proposal pursuant to this section and that the Commission's approval of the proposal shall not be taken to indicate that the Commission recommends the proposal; or
 - (b) if registration of a prospectus is not required under this Act in connection with the proposal, the applicant shall include in any document issued with respect to the proposal, in such form as the Commission may require, a statement that the Commission has approved the proposal pursuant to this section and that the Commission's approval of the proposal shall not be taken to indicate that the Commission recommends the proposal.
- (10) Where—
- (a) a person enters into an agreement in respect of a proposal; and
 - (b) the terms of the agreement are not binding until the fulfilment of any condition as may be set out in the agreement, including that of the approval to be given under subsection (5), the person shall not be taken, for the purposes of subsection (4), to have taken any step to implement or carry out the proposal.
- (11) In respect of any proposal referred to in subsection (2)—
- (a) the Commission may direct an applicant to make an announcement of a proposal in accordance with the rules of the stock exchange, if applicable; and
 - (b) any person may make an announcement of a proposal before submitting such proposal to the Commission for its approval under this section.
- (12) For the purpose of subsection (11), an "announcement" includes any publication by press notice or in any other form of a firm intention to make an offer for any securities.
- (13) A person who contravenes subsection (3), (4), (9) or (11) commits an offence and shall, on conviction, be liable to a fine not exceeding one million ringgit or to imprisonment for a term not exceeding ten years or to both.

Box A1.2 Division 3: Prospectus

CAPITAL MARKETS AND SERVICES ACT 2007
(Act 671)
As at 28 September 2007

PART VI

ISSUES OF SECURITIES AND TAKE-OVERS AND MERGERS**DIVISION 3 Prospectus**

- 226. Interpretation 173
- 227. Invitation 174
- 228. Offer for subscription or purchase 174
- 229. Excluded offers and invitations 174**
- 230. Excluded issues 175**
- 231. Exceptions 175
- 232. Requirement to register prospectus in relation to securities 176
- 233. Registration of prospectus 176
- 234. Requirement to lodge prospectus with Registrar 178
- 235. Contents of prospectus 178
- 236. General duty of disclosure in prospectus 180
- 237. Abridged prospectus for renounceable rights issues 181
- 238. Supplementary or replacement prospectus 182
- 239. Consequences of registering a supplementary or replacement prospectus 184
- 240. Regulations for shelf prospectuses, supplementary shelf prospectuses, short form prospectuses, profile statements, etc. 185
- 241. Restrictions in advertising 186
- 242. Document containing offer of securities for purchase deemed to be a prospectus 191
- 243. Allotment of securities where prospectus implies that application for permission to list on stock exchange had been made 192
- 244. Consent from person to issue of prospectus containing statement by him 194

Interpretation

226. In this Division, Divisions 4 and 5, unless the context otherwise requires—

“**approved company auditor**” means a person approved by the Minister under subsection 8(2) of the Companies Act 1965 as a company auditor and whose approval has not been revoked;

“**excluded invitation**” or “**excluded offer**” means an invitation or offer which is specified in **Schedule 6** or which is prescribed by the Minister to be an **excluded invitation or excluded offer under paragraph 229(1)(b)**;

“**excluded issue**” means an issue which is specified in **Schedule 7** or which is prescribed by the Minister to be an **excluded issue under paragraph 230(1)(b)**;

“**preliminary prospectus**” means any document which is designed to assist an issuer in setting a price in respect of a proposed issue of, an offer for subscription or purchase of, or an invitation to subscribe for or purchase, securities or to determine the final contents of a prospectus;

“**promoter**” means—

- (a) in relation to a prospectus issued by or in connection with a corporation, a promoter of the corporation;
- (b) in relation to a prospectus in respect of a unit trust scheme or prescribed investment scheme, a promoter of the scheme; or
- (c) in relation to a prospectus in any other case, a person, who is a party to the preparation of the prospectus or any relevant portion thereof, but does not include any person by reason only of his acting in a professional capacity;

“**prospectus**” means a notice, circular, advertisement or document inviting applications or offers to subscribe for or purchase securities, or offering any securities for subscription or purchase and, unless expressly specified, includes a supplementary prospectus, replacement prospectus, shelf prospectus, short form prospectus, profile statement, supplementary shelf prospectus and abridged prospectus;

“**shelf prospectus**” means a prospectus issued under a shelf registration scheme;

“**shelf registration scheme**” means a scheme applicable for the purpose of any issue of, offer for subscription or purchase of, or invitation to subscribe for or purchase, securities by an issuer based on a shelf prospectus and a supplementary shelf prospectus;

“**supplementary shelf prospectus**” means a document which provides material information necessary to update the information in a shelf prospectus subsequent to the registration of such shelf prospectus.

continued on next page

Box A1.2 continuation

Invitation

227. In this Part, a reference to an invitation includes a reference to an invitation to make an offer or application.

Offer for subscription or purchase

228. For the purposes of this Division and Division 5, the expression “offer for subscription or purchase” or “making an invitation to subscribe for or purchase”, in relation to units of a unit trust scheme or prescribed investment scheme, as the case may be, shall include the making available of such units.

Excluded offers and invitations

- 229. (1) An offer for subscription or purchase of, or an invitation to subscribe for or purchase, securities is an excluded offer or an excluded invitation if—**
- (a) **the offer or invitation is specified in Schedule 6(*: See below); or**
 - (b) **the offer or invitation is made to a person or a class of persons, or made in respect of securities or a class of securities, as the Minister may, on the recommendation of the Commission, prescribe by order published in the Gazette, to be an excluded offer or an excluded invitation.**
- (2) **Schedule 6** or a prescription made under paragraph (1)(b) may specify the provisions of this Act that shall not apply to an excluded offer or an excluded invitation.
- (3) An information memorandum issued by a person or his agent purporting to describe the business and affairs of the person in respect of—
- (a) any excluded offer or excluded invitation specified in Schedule 6; or
 - (b) any offer or invitation made to a person or a class of persons or any offer or invitation in relation to securities or a class of securities prescribed under paragraph (1)(b),

shall be deemed to be a prospectus insofar as it relates to the liability of the person or his agent for any statement or information that is false or misleading or from which there is a material omission.

- (4) A person issuing the information memorandum referred to in subsection (3) shall deposit a copy of the information memorandum with the Commission within seven days after it is first issued.
- (5) Paragraph 17 of Schedule 6 shall not apply to any securities or class of securities of any private company or class of private companies as the Minister may, on the recommendation of the Commission, prescribe by order published in the Gazette.

(*SCHEDULE 6

[Section 229]

Excluded offers or excluded invitations

A. Excluded offers or excluded invitations

1. An offer or invitation to enter into an underwriting or subunderwriting agreement or an offer or invitation made to an underwriter under such an agreement.
2. With respect to the securities of a corporation which are not listed, an offer or invitation made to existing members or debenture holders of such corporation by means of a rights issue and is not an offer to which section 237 applies.
3. An offer or invitation made to a company that is registered as a trust company under the Trust Companies Act 1949 or a corporation that is a public company under the Companies Act 1965 or under the laws of any other country which has been allowed by the Commission to be a trustee for the purposes of this Act.
4. An offer or invitation made to a unit trust scheme or prescribed investment scheme.
5. An offer or invitation made to a holder of a Capital Markets Services Licence who carries on the business of dealing in securities.
6. An offer or invitation made exclusively to persons outside Malaysia.
7. An offer or invitation made to a closed end fund approved by the Commission.
8. An offer or invitation made to a holder of a Capital Markets Services Licence who carries on the business of fund management.
9. An offer or invitation made to a person who acquires securities pursuant to an offer, as principal, if the aggregate consideration for the acquisition is not less than two hundred and fifty thousand ringgit or its equivalent in foreign currencies for each transaction whether such amount is paid for in cash or otherwise.
10. An offer or invitation made to an individual whose total net personal assets exceed three million ringgit or its equivalent in foreign currencies.
11. An offer or invitation made to a corporation with total net assets exceeding ten million ringgit or its equivalent in foreign currencies based on the last audited accounts.
12. An offer or invitation made to a licensed offshore bank as defined under the Offshore Banking Act 1990.
13. An offer or invitation made to an offshore insurer as defined under the Offshore Insurance Act 1990 [Act 444].

continued on next page

Box A1.2 continuation

14. An offer or invitation made with respect to any sale of a unit in a unit trust scheme or a prescribed investment scheme by a personal representative, liquidator, receiver or trustee in bankruptcy or liquidation, as the case may be, in the normal course of realisation of assets.
15. All trades in securities effected on a stock market of a stock exchange which is approved by the Minister pursuant to subsection 8(2) or such other exchange outside Malaysia which is recognised under the rules of the stock exchange.
16. An offer or invitation of securities made or guaranteed by the Federal Government or any State Government or Bank Negara.
17. An offer or invitation in respect of securities of a private company.
18. An offer or invitation pursuant to a take-over offer which complies with the relevant law applicable to such offers.
19. All trades in securities effected in the money market.
20. An offer or invitation made to employees or directors of a corporation or its related corporation pursuant to an employee share or employee share option scheme.
21. An offer or invitation made to any creditor or holder of securities of a company undergoing a scheme of arrangement or compromise under section 176 of the Companies Act 1965 or a restructuring scheme under the Pengurusan Danaharta Nasional Berhad Act 1998 which may not be renounced to any person other than a creditor or holder of securities of the company.
22. An offer or invitation made to a licensed institution as defined in the Banking and Financial Institutions Act 1989 or an Islamic bank as defined in the Islamic Banking Act 1983.
23. An offer or invitation made to an insurance company registered under the Insurance Act 1996.
24. An offer or invitation made to a statutory body established by an Act of Parliament or an enactment of any State.
25. An offer or invitation made to a pension fund approved by the Director General of Inland Revenue under section 150 of the Income Tax Act 1967 [Act 53].
26. An offer or invitation made by or to Danamodal Nasional Bhd.
27. An offer or invitation in respect of securities of a corporation made to existing members of a company within the meaning of section 270 of the Companies Act 1965.
28. An offer or invitation in respect of securities of a foreign corporation whose securities or any class of securities having gained admission on such other exchange outside Malaysia which is recognised under the rules of a stock exchange, made to existing members or debenture holders of such foreign corporation by means of a rights issue provided that such offer of invitation has been accompanied by a prospectus or disclosure document approved by the foreign supervisory authority of such foreign corporation.

B. Non-application

Excluded offers or excluded invitations to which sections 232, 233, 234, 235, 236, 237, 238, 239, 240, 241 and 244 of Division 3 of Part VI shall not apply.

Excluded issues**230. (1) An issue of securities is an excluded issue if—**

- (a) **the issue is so specified in Schedule 7(*: See below) ; or**
- (b) **the issue is made to a person or a class of persons, or made in respect of securities or a class of securities, as the Minister may, on the recommendation of the Commission, prescribe by order published in the Gazette.**

- (2) Schedule 7 or a prescription made under paragraph (1)(b) may specify the provisions of this Act that shall not apply to an excluded issue.
- (3) An information memorandum issued by a person or his agent purporting to describe the business and affairs of the person in respect of—
 - (a) any excluded issue specified in Schedule 7; or
 - (b) any issue of securities made to a person or a class of persons or in relation to securities or a class of securities prescribed under paragraph (1)(b),

shall be deemed to be a prospectus insofar as it relates to the liability of the person or his agent for any statement or information that is false or misleading or from which there is a material omission.

- (4) A person issuing the information memorandum referred to in subsection (3) shall deposit a copy of the information memorandum with the Commission within seven days after it is first issued.
- (5) Paragraph 17 of Schedule 7 shall not apply to any securities or class of securities of any private company or class of private companies as the Minister may, on the recommendation of the Commission, prescribe by order published in the Gazette.

continued on next page

Box A1.2 continuation

(*)Schedule 7

[Section 230]

Excluded issues

A. Excluded issues

1. An issue made to an underwriter under an underwriting or subunderwriting agreement.
2. An issue in respect of securities of a corporation which are not listed made to existing members or debenture holders of such corporation by means of a rights issue and is not an issue or allotment to which section 237 applies.
3. An issue made to a company that is registered as a trust company under the Trust Companies Act 1949 or a corporation that is a public company under the Companies Act 1965 or under the laws of any other country which has been allowed by the Commission to be a trustee for the purposes of this Act.
4. An issue made to a unit trust scheme or prescribed investment scheme.
5. An issue made to a holder of a Capital Markets Services Licence who carries on the business of dealing in securities.
6. An issue made exclusively to persons outside Malaysia.
7. An issue made to a closed end fund approved by the Commission.
8. An issue made to a holder of a Capital Markets Services Licence who carries on the business of fund management.
9. An issue made to a person who acquires securities pursuant to an offer, as principal, if the aggregate consideration for the acquisition is not less than two hundred and fifty thousand ringgit or its equivalent in foreign currencies for each transaction, whether such amount is paid for in cash or otherwise.
10. An issue made to an individual whose total net personal assets exceed three million ringgit or its equivalent in foreign currencies.
11. An issue made to a corporation with total net assets exceeding ten million ringgit or its equivalent in foreign currencies based on the last audited accounts.
12. An issue made to a licensed offshore bank as defined under the Offshore Banking Act 1990.
13. An issue made to an offshore insurer as defined under the Offshore Insurance Act 1990.
14. An issue made with respect to any sale of a unit in a unit trust scheme or a prescribed investment scheme by a personal representative, liquidator, receiver or trustee in bankruptcy or liquidation, as the case may be, in the normal course of realisation of assets.
15. All trades in securities effected on a stock market of a stock exchange which is approved by the Minister pursuant to subsection 8(2) or such other exchange outside Malaysia which is recognised under the rules of the stock exchange.
16. An issue of securities made or guaranteed by the Federal Government or any State Government or Bank Negara.
17. An issue in respect of securities of a private company.
18. An issue in respect of securities which are acquired pursuant to a take-over offer which complies with the relevant law applicable to such offers.
19. All trades in securities effected in the money market.
20. An issue in respect of securities which are acquired by employees or directors of a corporation or its related corporation pursuant to an employee share or employee share option scheme.
21. An issue made to any creditor or holder of securities of a company undergoing a scheme of arrangement or compromise under section 176 of the Companies Act 1965 or a restructuring scheme under the Pengurusan Danaharta Nasional Berhad Act 1998 which may not be renounced to any person other than a creditor or holder of securities of the company.
22. An issue made to a licensed institution as defined in the Banking and Financial Institutions Act 1989 or an Islamic bank as defined in the Islamic Banking Act 1983.
23. An issue made to an insurance company registered under the Insurance Act 1996.
24. An issue made to a statutory body established by an Act of Parliament or an enactment of any State.
25. An issue made to a pension fund approved by the Director General of Inland Revenue under section 150 of the Income Tax Act 1967.
26. An issue made by or to Danamodal Nasional Bhd.
27. An issue of securities by a corporation pursuant to the exercise of an option, a warrant or a transferable subscription right, in respect of which a prospectus has been registered under this Act or in respect of which the securities to which the option, warrant or transferable subscription right converts into are listed securities.
28. An issue of shares by a corporation pursuant to a provision contained in a convertible note, whether the note was issued by that corporation or by another corporation, in respect of which a prospectus has been registered under this Act or in respect of which the securities to which the option, warrant or transferable subscription right converts into are listed securities.
29. An issue in respect of shares or units in a unit trust scheme or prescribed investment scheme which are issued in satisfaction of dividends payable by the issuer to the holders of existing shares or units that were issued pursuant to a prospectus.
30. An issue of securities of a corporation made to existing members of a company within the meaning of section 270 of the Companies Act 1965.

continued on next page

Box A1.2 continuation

31. A bonus issue of securities made by a corporation.
32. An issue in respect of securities of a foreign corporation whose securities or any class of securities having gained admission on such other exchange outside Malaysia which is recognised under the rules of a stock exchange, made to existing members or debenture holders of such foreign corporation by means of a rights issue.
33. An issue of securities of a foreign corporation whose securities or any class of securities having gained admission on such other exchange outside Malaysia which is recognised under the rules of a stock exchange, made to existing members or debenture holders of such foreign corporation by means of a rights issue provided that such issue has been accompanied by a prospectus or disclosure document approved by the foreign supervisory authority of such foreign corporation.

B. Non-application

Excluded issues to which sections 232, 233, 234, 235, 236, 237, 238, 239, 240, 241 and 244 of Division 3 of Part VI shall not apply.

Exceptions

- 231.** (1) The provisions of this Division as specified in Schedule 6 or 7 or as may be prescribed by the Minister pursuant to paragraph 229(1)(b) or 230(1)(b) shall not apply to—
- (a) an excluded offer;
 - (b) an excluded invitation; or
 - (c) an excluded issue.
- (2) The provisions of this Part shall not apply to the making available of, the offer for subscription or purchase of, or an invitation to subscribe for or purchase, shares or debentures of any unlisted recreational club.

Requirement to register prospectus in relation to securities

- 232.** (1) A person shall not issue, offer for subscription or purchase, make an invitation to subscribe for or purchase or in the case of an initial listing of securities, make an application for the quotation of the securities on a stock market of a stock exchange unless—
- (a) a prospectus in relation to the securities has been registered by the Commission under section 233; and
 - (b) the prospectus complies with the requirements or provisions of this Act.
- (2) Unless authorised in writing by the Commission, a person shall not issue, circulate or distribute any form of application for securities unless the form is accompanied by a copy of a prospectus which has been registered by the Commission under section 233.
- (3) A person shall not issue, circulate or distribute any form of application for securities of a corporation that has not been formed or of a unit trust scheme or prescribed investment scheme that has not been formed.
- (4) The Commission may for public information publish the registrable prospectus submitted to the Commission before the registration of the prospectus under section 233.
- (5) The publication under subsection (4) shall not indicate that the Commission recommends the securities or assumes responsibility for the correctness of any statements made or opinions or reports expressed in the registrable prospectus.
- (6) For the purposes of this section, a “registrable prospectus” refers to a prospectus that has been submitted under section 233 and which has yet to be registered by the Commission.
- (7) A person who contravenes subsection (1), (2) or (3) commits an offence and shall, on conviction, be liable to a fine not exceeding ten million ringgit or to imprisonment for a term not exceeding ten years or to both.

Registration of prospectus

- 233.** (1) The Commission shall refuse to register a prospectus if—
- (a) the Commission is of the opinion that the prospectus does not comply with any provision of this Act;
 - (b) the issue of, offer for subscription or purchase of, or invitation to subscribe for or purchase, securities to which the prospectus relates does not comply with any other requirement or provision of this Act;
 - (c) the Commission is of the opinion that the prospectus contains any statement or information that is false or misleading or that the prospectus contains any statement or information from which there is a material omission;
 - (d) the issue of, offer for subscription or purchase of, or invitation to subscribe for or purchase, securities to which the prospectus relates—
 - (i) requires the approval of the Commission under section 212 and such approval has not been given; or
 - (ii) does not comply with any term or condition imposed under subsection 212(5);
 - (e) in relation to a unit trust scheme or prescribed investment scheme, there has been a failure to comply with any term or condition in relation to an approval of a management company or trustee; or
 - (f) the Commission is of the opinion that the issuer has contravened any provision of the securities laws or the Companies Act 1965 and that such contravention would cast a doubt as to whether the issuer is a fit and proper person to make an issue of, offer for subscription or purchase of, or invitation to subscribe for or purchase, any securities.

continued on next page

Box A1.2 continuation

- (2) No prospectus shall be registered unless it is submitted to the Commission together with—
- (a) a written application for its registration;
 - (b) copies of all consents required under subsection 244(1) from any person named in the prospectus as having made a statement that is included in the prospectus or on which a statement made in the prospectus is based;
 - (c) copies of all material contracts referred to in the prospectus or, in the case of a contract not reduced into writing, a memorandum giving full particulars thereof, verified in accordance with any requirements specified by the Commission; and
 - (d) all such information or documents as may be required by the Commission.
- (3) An issuer shall cause a copy of—
- (a) any consent required under subsection 244(1) in relation to the issue of the prospectus; and (b) every material contract or document referred to in the prospectus, to be deposited—
- (A) at the registered office of the issuer in Malaysia, and if it has no registered office in Malaysia, at the address specified in the prospectus for that purpose; and
- (B) in the case of a unit trust scheme or prescribed investment scheme, at the registered office of the issuer and the trustee in Malaysia, at the address specified in the prospectus for that purpose, within three days after the registration of the prospectus and shall keep each such copy, for such period as may be specified by the Commission, for inspection by any person without charge.

Requirement to lodge prospectus with Registrar

- 234.** An issuer shall cause a copy of the prospectus registered by the Commission under this Act and a copy of the form of application accompanying such prospectus—
- (a) in relation to securities other than a unit trust scheme or prescribed investment scheme, to be lodged with the Registrar;
 - (b) in relation to a unit trust scheme or prescribed investment scheme, to be lodged with the Commission, before the date of issue of the prospectus.

Contents of prospectus

- 235.** (1) Without prejudice to section 236, a prospectus—
- (a) shall be dated and that date shall, unless the contrary is proved, be taken as the date of issue of the prospectus;
 - (b) shall state that—
 - (i) the prospectus has been registered by the Commission;
 - (ii) in respect of securities other than a unit trust scheme or prescribed investment scheme, a copy of the prospectus is lodged with the Registrar and in respect of a unit trust scheme or prescribed investment scheme, a copy of the prospectus is lodged with the Commission; and
 - (iii) the registration of the prospectus shall not be taken to indicate that the Commission recommends the securities or assumes responsibility for the correctness of any statements made or opinions or reports expressed in the prospectus;
 - (c) shall contain a statement that no securities will be allotted or issued on the basis of the prospectus later than such period as the Commission may specify from the date of issue of the prospectus;
 - (d) shall, if it contains any statement made by an expert or contains what purports to be a copy of or an extract from a report, memorandum or valuation of an expert, state the date on which the statement, report, memorandum or valuation was made and whether or not it was prepared by the expert for incorporation in the prospectus;
 - (e) shall not contain the name of any person named in the prospectus as having made a statement—
 - (i) that is included in the prospectus; or
 - (ii) on which a statement made in the prospectus is based, unless the requirements of subsection 244(1) are satisfied; and
 - (f) shall set out such information, matters or reports as may be specified by the Commission.
- (2) A condition requiring or binding an applicant for securities to waive compliance with any requirement of this section or section 236, or purporting to affect him with notice of any contract, document or matter not specifically referred to in the prospectus, shall be void.
- (3) Notwithstanding the provisions of this Division, the Commission may, either on the written application of any person referred to in section 232 or of its own accord, make an order relieving such person from or approving any variation of the requirements of this Act relating to the form and content of a prospectus.
- (4) In making an order under subsection (3), the Commission may impose such terms and conditions as it thinks fit.
- (5) The Commission shall not make an order under subsection (3) unless it is satisfied that—
- (a) compliance with the requirements of this Act is unnecessary for the protection of persons who may normally be expected to deal in those securities, being persons who would reasonably be expected to understand the risks involved; or
 - (b) compliance with the requirements of this Act would impose an unreasonable burden on the issuer.
- (6) A prospectus shall be deemed to have complied with all the requirements of this Act relating to the form and content of a prospectus if it is issued in compliance with an order made under subsection (3).
- (7) Where a prospectus relating to any securities is issued and the prospectus does not comply with the requirements of this section, the issuer and each director of the issuer at the time of the issue of the prospectus commits an offence and shall, on conviction, be liable to a fine not exceeding

continued on next page

Box A1.2 continuation

three million ringgit or to imprisonment for a term not exceeding ten years or to both.

(8) A person who contravenes any term or condition as may be imposed by the Commission under subsection (4) commits an offence.

General duty of disclosure in prospectus

236. (1) For the purpose of determining whether a prospectus contains any statement or information which is false or misleading or from which there is a material omission under subsection 246(1) or 248(1), regard shall be had to whether the prospectus contains all such information that investors and their professional advisers would reasonably require, and reasonably expect to find in the prospectus, for the purpose of making an informed assessment of—

- (a) the assets and liabilities, financial position, profits and losses and prospects of the issuer and, in the case of a unit trust scheme or prescribed investment scheme, of the scheme;
- (b) the rights attaching to the securities; and
- (c) the merits of investing in the securities and the extent of the risk involved in doing so.

(2) The information that investors and their professional advisers would reasonably require and reasonably expect to find in the prospectus under subsection (1) is information—

- (a) which is known to all or any of the following persons:
 - (i) a person who was a director of the issuer at the time of issue of the prospectus;
 - (ii) a person who has consented or caused himself to be named and is named in the prospectus as a director or as having agreed to become a director, either immediately or after an interval of time;
 - (iii) a promoter;
 - (iv) the principal adviser in relation to an issue of, offer for subscription or purchase of, or invitation to subscribe for or purchase, securities;
 - (v) a person named in the prospectus, with his consent, as having made a statement that is included in the prospectus or on which a statement made in the prospectus is based;
 - (vi) a person named in the prospectus, with his consent, as a stockbroker, sharebroker or underwriter, as the case may be, in relation to an issue of, offer for subscription or purchase of, or invitation to subscribe for or purchase, securities;
 - (vii) a person named in the prospectus, with his consent, as an auditor, banker or advocate in relation to an issue of, offer for subscription or purchase of, or invitation to subscribe for or purchase, securities;
 - (viii) a person named in the prospectus, with his consent, as having performed or performing any function in a professional, advisory or other capacity not mentioned in paragraph (iv), (v), (vi) or (vii) in relation to an issue of, offer for subscription or purchase of, or invitation to subscribe for or purchase, securities; or
- (b) which any of the persons referred to in paragraph (2)(a) would have been able to obtain by making such enquiries as were reasonable in the circumstances.

(3) Without prejudice to the generality of subsection (1) or (2), in determining the information that is required to be included in a prospectus under this section, regard shall be had to—

- (a) the nature of—
 - (i) the securities;
 - (ii) the business of the issuer of the securities; and
 - (iii) the unit trust scheme or prescribed investment scheme;
- (b) the persons likely to consider acquiring such securities;
- (c) the fact that certain matters may reasonably be expected to be known to any professional adviser whom investors referred to in subsection 236(1) may reasonably be expected to consult; and
- (d) whether the persons to whom an issue of, offer for subscription or purchase of, or invitation to subscribe for or purchase, securities is to be made are the holders of securities in the corporation, or unit holders in the unit trust scheme or prescribed investment scheme, and if they are, to what extent (if any) relevant information has previously been given to them by the issuer under any law or any requirement of the rules of a stock exchange, if applicable, or otherwise.

Abridged prospectus for renounceable rights issues

237. (1) A corporation shall not issue, offer for subscription or purchase, or make an invitation to subscribe for or purchase, securities by means of a rights issue which is renounceable in favour of persons other than existing members or debenture holders of that corporation and in respect of which an application has been or will be made for permission to deal with or quote such securities on a stock market of a stock exchange unless an abridged prospectus is registered by the Commission.

(2) Any abridged prospectus registered pursuant to subsection (1) shall contain such particulars or information as may be specified by the Commission.

(3) Nothing in this section shall be construed as preventing a full prospectus from being registered containing the particulars specified by the Commission in respect of full prospectuses in respect of an issue, offer or invitation referred to in subsection (1).

Supplementary or replacement prospectus

238. (1) This section applies—

- (a) in the case of a unit trust scheme or prescribed investment scheme, where a prospectus has been registered; or
- (b) in any other case, where a prospectus has been registered but before the issue of securities, and where the issuer becomes aware that—

continued on next page

Box A1.2 continuation

- (A) a matter has arisen and information in respect of that matter would have been required by—
- (i) section 235 or 236;
 - (ii) any requirement under this Act;
 - (iii) any guidelines issued by the Commission; or
 - (iv) any listing requirement of a stock exchange, to be disclosed in the prospectus if the matter had arisen at the time the prospectus was prepared;
- (B) there has been a significant change affecting a matter disclosed in the prospectus;
- (C) the prospectus contains a material statement or information that is false or misleading; or
- (D) the prospectus contains a statement or information from which there is a material omission.
- (2) As soon as practicable after becoming aware of a matter referred to in subsection (1), the issuer shall submit a supplementary or replacement prospectus, as the case may be, to the Commission for registration.
- (3) The issuer shall lodge the supplementary or replacement prospectus, as the case may be—
- (a) in relation to securities other than a unit trust scheme or prescribed investment scheme, with the Registrar immediately upon registration by the Commission; and
 - (b) in relation to a unit trust scheme or prescribed investment scheme, with the Commission immediately upon registration by the Commission.
- (4) Subsection (1) shall apply with respect to matters contained in a supplementary or replacement prospectus, as the case may be, previously registered under this section in respect of the securities in question.
- (5) On each page of a supplementary prospectus, there shall be a clear statement in bold type that states that the document is a supplementary prospectus that is to be read in conjunction with the original prospectus and if other supplementary prospectuses have been issued in relation to the original prospectus, both the original prospectus and the supplementary prospectuses.
- (6) At the beginning of the replacement prospectus, there shall be a clear statement in bold type that states the document is a replacement prospectus, and identifies the prospectus which it replaces.
- (7) A supplementary prospectus shall be regarded as being part of the prospectus to which it relates and the provisions of this Act and any other law relating to liability in respect of statements in and omissions from prospectuses or otherwise relating to prospectuses shall apply to such supplementary prospectus and shall have effect accordingly.
- (8) A replacement prospectus shall be regarded as replacing the prospectus previously registered under section 233.
- (9) Where a supplementary prospectus has been registered by the Commission, every copy of the original prospectus issued after registration of the supplementary prospectus must be accompanied by a copy of the supplementary prospectus.
- (10) Notwithstanding the provisions of this section, the Commission may, on the written application of any issuer or of its own accord, make an order relieving such person from, or approving any variation of, the requirements of this section.
- (11) In making an order under this section, the Commission may impose such terms and conditions as it thinks fit.
- (12) The Commission shall not make an order under subsection (10) unless it is satisfied that—
- (a) compliance with the requirements of this Act is unnecessary for the protection of persons who may normally be expected to deal in those securities, being persons who would reasonably be expected to understand the risks involved; or
 - (b) compliance with the requirements of this Act would impose an unreasonable burden on the issuer.
- (13) A person who contravenes subsection (2), (3), (5), (6) or (9) commits an offence and shall, on conviction, be liable to a fine not exceeding three million ringgit or to imprisonment for a term not exceeding ten years or to both.
- (14) A person who contravenes any term or condition as may be imposed by the Commission under subsection (11) commits an offence.

Consequences of registering a supplementary or replacement prospectus

- 239.** (1) This section applies—
- (a) where a person (“the applicant”) applies for the issue of, subscription or purchase of, any securities pursuant to a prospectus and—
 - (i) in the case of a unit trust scheme or prescribed investment scheme, before the issue of units or transfer of units from the management company or the trustee to the applicant; or
 - (ii) in any other case, before the issue of securities; and
 - (b) the issuer delivers to the Commission for registration a supplementary or replacement prospectus, as the case may be, that relates to the prospectus.
- (2) As soon as practicable after the registration of the supplementary or replacement prospectus, as the case may be, by the Commission, the issuer shall—

continued on next page

Box A1.2 continuation

- (a) give to the applicant a written notice or such other notice as may be specified by the Commission—
 - (i) advising the applicant that a supplementary or replacement prospectus, as the case may be, has been registered by the Commission;
 - (ii) giving the applicant not less than fourteen days from the date of receipt of the notice an opportunity to withdraw his application; and
 - (b) ensure that the written notice referred to in paragraph (2)(a) is accompanied by a copy of a supplementary or replacement prospectus, as the case may be.
- (3) If the applicant withdraws his application pursuant to subparagraph (2)(a)(ii), the issuer shall immediately pay to the applicant any monies that the applicant has paid to the issuer on account of the application.
- (4) Notwithstanding the provisions of this section, the Commission may, on the written application of any issuer or of its own accord, make an order relieving such person from, or approving any variation of, the requirements of this section.
- (5) In making an order under this section, the Commission may impose such terms and conditions as it thinks fit.
- (6) The Commission shall not make an order under subsection (4) unless it is satisfied that—
- (a) compliance with the requirements of this Act is unnecessary for the protection of persons who may normally be expected to deal in those securities, being persons who would reasonably be expected to understand the risks involved; or
 - (b) compliance with the requirements of this Act would impose an unreasonable burden on the issuer.
- (7) A person who contravenes subsection (2) or (3) commits an offence and shall, on conviction, be liable to a fine not exceeding three million ringgit or to imprisonment for a term not exceeding ten years or to both.
- (8) A person who contravenes any term or condition as may be imposed by the Commission under subsection (5) commits an offence.

Regulations for shelf prospectuses, supplementary shelf prospectuses, short form prospectuses, profile statements, etc.

- 240.** (1) Notwithstanding the provisions of sections 235 and 236, a person may issue, offer or subscription or purchase, or make an invitation to subscribe for or purchase, securities where at the time of the issue, offer or invitation there is in force—
- (a) a shelf prospectus as updated by a supplementary shelf prospectus;
 - (b) a short form prospectus; or
 - (c) a profile statement, relating to all matters which the Commission, with the approval of the Minister, may provide by way of regulations made under this Act with respect to a shelf prospectus, supplementary shelf prospectus, short form prospectus or profile statement, as the case may be.
- (2) The regulations referred to under subsection (1) may provide for, but shall not be limited to, the following matters:
- (a) a shelf prospectus, including a supplementary shelf prospectus;
 - (b) a short form prospectus;
 - (c) a profile statement;
 - (d) the period during which a person may be permitted to issue, offer for subscription or purchase, or make an invitation to subscribe for or purchase, securities on the basis of a shelf prospectus, as updated by a supplementary shelf prospectus, short form prospectus or profile statement, as the case may be;
 - (e) the form and content of a prospectus referred to in paragraph (a), (b) or (c);
 - (f) the persons or classes of persons to which any prospectus referred to in paragraph (a), (b) or (c) may apply; or
 - (g) the securities or classes of securities to which any prospectus referred to in paragraph (a), (b) or (c) may apply.
- (3) Where the Commission makes regulations under subsection (1) with respect to a shelf prospectus, supplementary shelf prospectus, short form prospectus or profile statement, the provisions of this Act and any other law relating to liability in respect of statements in or omissions from prospectuses or otherwise relating to prospectuses shall apply to the shelf prospectus, supplementary shelf prospectus, short form prospectus or profile statement, as the case may be, and shall have effect accordingly.

Box A1.3 DIVISION 4: Debentures**CAPITAL MARKETS AND SERVICES ACT 2007 (Act 671)**

As at 28 September 2007

DIVISION 4 Debentures**Subdivision 1 – Trust deeds, duties of trustees, borrowers, etc.**

- 257. Application of this Division 203
- 258. Requirement for trust deed and trustee 203
- 259. Form and contents of trust deeds 204
- 260. Persons who can be trustees 204

continued on next page

Box A1.3 continuation

261. Existing trustee to continue to act until new trustee takes office 206
 262. Replacement of trustee 206
 273. Duties of trustees 215
 274. Exemptions and indemnification of trustee from liability 218
 275. Indemnity of trustee 219
 276. Duty of auditor to trustee for debenture holders 219

Subdivision 2 – General

283. Register of debenture holders 224

Application of this Division

- 257.** (1) The provisions of this Subdivision and section 283 shall not apply to any issue of, offer for subscription or purchase of, or invitation to subscribe for or purchase, debentures specified in Schedule 8.
- (2) The provisions of this Division as specified in Schedule 9 shall not apply to any issue of, offer for subscription or purchase of, or invitation to subscribe for or purchase, debentures specified in Schedule 9.
- (3) The provisions of this Division shall not apply to an issue, offer or invitation that is made to a person or a class of persons, or made in respect of a debenture or a class of debentures, as the Minister may, on the recommendation of the Commission, prescribe by order published in the Gazette.
- (4) A prescription made under subsection (3) may specify the provisions of this Division to which an issue, offer or invitation shall not apply.

Requirement for trust deed and trustee

- 258.** (1) Every person issuing, offering for subscription or purchase, or making an invitation to subscribe for or purchase, any debenture shall—
- enter into a trust deed that meets the requirements of section 259;
 - appoint a trustee who is a person eligible to be appointed or to act as trustee in accordance with section 260; and
 - comply with the requirements and provisions of this Division.
- (2) A person issuing, offering for subscription or purchase, or making an invitation to subscribe for or purchase, any debenture shall not allot such debenture unless the person has entered into a trust deed that meets with the requirements of section 259 and has appointed a trustee who is a person eligible to be appointed or to act as trustee under section 260.
- (3) A person issuing, offering for subscription or purchase, or making an invitation to subscribe for or purchase, any debenture shall not revoke the trust deed unless the person has repaid all amounts payable under the debenture in accordance with the terms, provisions and covenants of the debenture and the trust deed.
- (4) A person who contravenes subsection (1), (2) or (3) commits an offence and shall, on conviction, be liable to a fine not exceeding three million ringgit or to imprisonment for a term not exceeding ten years or to both.

Form and contents of trust deeds

- 259.** (1) A trust deed shall contain such provisions, covenants, requirements, information and particulars as may be specified by the Commission.
- (2) A person issuing, offering for subscription or purchase, or making an invitation to subscribe for or purchase, any debenture shall deliver a copy of the trust deed to the Commission together with such other particulars, information or documents as the Commission may specify.

Persons who can be trustees

- 260.** (1) A trustee shall be—
- a company registered as a trust company under the Trust Companies Act 1949 [Act 100]; or
 - a corporation that is a public company under the Companies Act 1965 or under the laws of any other country, which has been approved by the Commission to act as trustee for the purposes of this Act.
- (2) A person shall not be eligible to be appointed or to act as trustee for debenture holders without the approval of the Commission if the person—
- is a shareholder who beneficially holds shares in the borrower;
 - is beneficially entitled to monies owed by the borrower to it;
 - has entered into a guarantee in respect of the amount secured or payable under the debenture; or
 - is a related corporation of—
 - the persons referred to in paragraphs (a) to (c); or
 - the borrower.
- (3) An application for approval made under subsection (1) or (2) shall be made to the Commission in accordance with such procedure or other requirement as may be specified by the Commission.

continued on next page

Box A1.3 continuation

- (4) Notwithstanding the provisions of subsection (2), a person is not prevented from being appointed or from acting as trustee by reason only that—
- (a) the borrower owes to the trustee or any related corporation of the trustee any monies, so long as such monies are—
 - (i) monies that do not, at the time of the appointment or at any time within a period of three months after the debentures are first offered for subscription or purchase or in respect of which an invitation to subscribe for or purchase is made, exceed one-tenth of the amount of the debentures proposed to be issued within that period and do not, at any time after the expiration of that period, exceed one tenth of the amount the borrower owes to the holders of the debentures; or
 - (ii) monies to which the trustee or any related corporation of the trustee is entitled to as trustee for holders of any debenture of the borrower, in accordance with the terms, provisions or covenants of the debenture or the trust deed; or
 - (b) the trustee or a related corporation of the trustee, despite being beneficial owners in the shares of the borrower, do not have the right to exercise more than one-twentieth of the voting power at any general meeting of the borrower.
- (5) Where an application has been made to the Commission under subsection (3), the Commission may approve such application subject to such terms and conditions as it thinks fit.
- (6) In exercising its discretion under subsection (5), the Commission shall have regard to—
- (a) the interests of holders of any debenture; and
 - (b) the ability of the trustee to safeguard the interests of such debenture holders as required by the provisions and covenants of the trust deed and the provisions of this Act.
- (7) The Commission may revoke its approval under subsection (5) where the trustee has failed to comply with any term or condition imposed under subsection (5) or has contravened any provision of this Act.
- (8) A trustee who—
- (a) contravenes subsection (1) or (2); or
 - (b) contravenes a term or condition imposed by the Commission under subsection (5), commits an offence and shall, on conviction, be liable to a fine not exceeding five hundred thousand ringgit or to imprisonment for a term not exceeding three years or to both.

Existing trustee to continue to act until new trustee takes office

261. Notwithstanding the provisions of section 43 of the Trustee Act 1949 [Act 208] or any term, provision or covenant in the debenture or trust deed, an existing trustee shall continue to act as trustee until a new trustee is appointed and has taken office as trustee.

Replacement of trustee

- 262.** (1) Where no provision has been made in the debenture or trust deed for the appointment of a successor to a retiring trustee, the borrower shall, within one month after becoming aware of the intention of the trustee to retire, appoint as successor to the retiring trustee a trustee who is a person eligible to be appointed or to act as trustee under section 260.
- (2) A court may, on the application of the borrower, a debenture holder or the Commission—
- (a) appoint, as trustee, a person who is eligible to be appointed or to act as trustee under section 260 if—
 - (i) the trustee has not been validly appointed; or
 - (ii) the trustee has ceased to exist; or
 - (b) terminate the appointment of an existing trustee and appoint in his place, as trustee, a person who is eligible to be appointed or to act as trustee under section 260 if—
 - (i) the existing trustee is not eligible to be appointed or to act as trustee under section 260;
 - (ii) the existing trustee fails or refuses to act in accordance with the provisions or covenants of the trust deed or the provisions of this Act;
 - (iii) a receiver is appointed over the whole or a substantial part of the assets or undertaking of the existing trustee and has not ceased to act under that appointment, or a petition is presented for the winding up of the existing trustee (other than for the purpose of and followed by a reconstruction, unless during or following such reconstruction the existing trustee becomes or is declared to be insolvent); or
 - (iv) the trustee is under investigation for conduct that contravenes the Trust Companies Act 1949, the Trustee Act 1949, the Companies Act 1965 or the securities law.
- (3) A borrower who contravenes subsection (1) commits an offence.

Duties of trustees

- 273.** (1) The trustee of a trust deed that is entered into under section 258—
- (a) shall satisfy itself that the provisions of a prospectus or an information memorandum relating to the debenture do not contain any matter which is inconsistent with the terms, provisions and covenants of the debenture and the trust deed;
 - (b) shall ensure that the borrower and each guarantor complies with Division 7 of Part IV of the Companies Act 1965, to the extent that it applies to the debenture;

continued on next page

Box A1.3 continuation

- (c) shall take reasonable steps to ensure that the borrower or guarantor remedies any breach of the terms, provisions or covenants of the debenture or the trust deed or any contravention of the provisions of this Act;
 - (d) shall notify the Commission as soon as practicable if the borrower or guarantor fails to remedy any breach of the terms, provisions or covenants of the debenture or the trust deed or any contravention of the provisions of this Act;
 - (e) shall, where the borrower or the guarantor fails to remedy any breach of the terms, provisions or covenants of the debenture or the trust deed or any contravention of the provisions of this Act, call for a meeting of debenture holders and place before the meeting proposals for the protection of the interest of the debenture holders as the trustee considers necessary or appropriate and obtain their directions; and
 - (f) shall notify the Commission as soon as practicable where the trustee discovers that it is not eligible to be appointed or to act as trustee under section 260.
- (2) Where a proposal relating to a debenture is approved by the Commission under section 212, the trustee shall—
- (a) exercise reasonable diligence to ascertain whether the assets of the borrower and of each guarantor which are or may be available, whether by way of security or otherwise, are insufficient or are likely to become insufficient to repay the amount secured or payable under the debenture to which the trust deed relates when it becomes due;
 - (b) notify the Commission as soon as practicable if—
 - (i) the borrower has contravened section 265 or 266; or
 - (ii) a guarantor has contravened paragraph 271(1)(d);
 - (c) where the borrower or the guarantor fails to remedy any breach of the terms, provisions or covenants of the debenture or the trust deed or any contravention of the provisions of this Act call for a meeting of debenture holders and place before the meeting proposals for the protection of the interest of the debenture holders as the trustee considers necessary or appropriate and obtain their directions;
 - (d) comply with any directions given to it at a debenture holders' meeting referred to in sections 277, 278 and 279 unless—
 - (i) the trustee is of the opinion that the direction is inconsistent with the terms, provision or covenant of the debenture or the trust deed or the provisions of this Act or is otherwise objectionable; and
 - (ii) the trustee has either obtained, or is in the process of obtaining, an order from the court under section 282 to set aside or vary that direction;
 - (e) give the debenture holders a statement explaining the effect of any proposal that the borrower submits to the debenture holders before any meeting that—
 - (i) the court calls in relation to a scheme of arrangement or compromise under subsection 176(1) of the Companies Act 1965; or
 - (ii) the trustee calls under subsection 278(1);
 - (f) apply to the Commission for a direction under subsection 280(1) where the trustee upon due inquiry is of the opinion that the assets of the borrower and the guarantor which are or should be available, whether by way of security or otherwise, are insufficient or are likely to become insufficient to repay the amount secured or payable under the debenture to which the trust deed relates as and when it becomes due;
 - (g) apply to court for an order under section 282 where—
 - (i) the trustee upon due inquiry is of the opinion that the assets of the borrower and the guarantor which are or should be available, whether by way of security or otherwise, are insufficient or are likely to become insufficient to repay the amount secured or payable under the debenture to which the trust deed relates as and when it becomes due; or
 - (ii) the borrower has failed to comply with a direction made by the Commission under subsection 280(1); and
 - (h) where the prospectus relating to the debenture contains a statement as to the particular purpose or project for which such amount are to be applied and—
 - (i) it appears to the trustee that the purpose or project has not been achieved within the time stated in the prospectus or where no time is stated, within a reasonable time; or
 - (ii) it is the trustee's opinion that notice is necessary for the protection of the interests of debenture holders, give a notice in writing to the borrower requiring it to repay the amounts secured or payable under the debenture to which the trust deed relates within one month after the notice is given and deliver a copy of that notice to the Commission, unless the trustee is satisfied of any or all of the following:
 - (A) that the purpose or project has been substantially achieved or completed; or
 - (B) that the interests of debenture holders have not been materially prejudiced by the failure to achieve or complete the purpose or project within the time stated in the prospectus or within a reasonable time.
- (3) For the purposes of paragraphs (2)(f) and (g), a trustee in making any application to the Commission or to the court—
- (a) shall have regard to the nature and kind of security given when the debentures were first issued or, if no security was given, shall have regard to the position of debenture holders as unsecured creditors of the borrower; and
 - (b) may rely on any certificate or report given or statement made by any advocate, auditor or officer of the borrower or the guarantor if it has reasonable grounds for believing that the advocate, auditor or officer was competent to give or make the certificate, report or statement.
- (4) A trustee who contravenes subsection (1) shall not be guilty of an offence.

continued on next page

Box A1.3 continuation

Exemptions and indemnification of trustee from liability

- 274.** (1) Subject to this section, a term, provision or covenant of a debenture or a trust deed or a term of a contract with holders of debentures secured by a trust deed shall be void insofar as the term, provision or covenant, as the case may be, would have the effect of—
- (a) exempting a trustee from liability for contravention of any provision of this Act or for breach of trust or for failure to show the degree of care and diligence required of it as trustee; or
 - (b) indemnifying a trustee against liability for contravention of any provision of this Act or for breach of trust or for failure to show the degree of care and diligence required of it as trustee, unless the term, provision or covenant—
- (A) releases the trustee from liability for anything done or omitted to be done before the release is given; or
 - (B) enables a meeting of debenture holders to approve the release of a trustee from liability for anything done or omitted to be done before the release is given.
- (2) For the purpose of paragraph (1)(B)—
- (a) a release is approved if the debenture holders who vote for the resolution hold seventy-five percent of the nominal value of the debentures held by all the debenture holders who attend the meeting and vote on the resolution; and
 - (b) a debenture holder attends the meeting and votes on the resolution if—
 - (i) such debenture holder attends the meeting in person and votes on the resolution; or
 - (ii) if proxies are permitted, the debenture holder is represented at the meeting by a proxy and the proxy votes on the resolution.

Indemnity of trustee

- 275.** (1) A trustee is not liable for anything done or omitted to be done in accordance with a direction given to the trustee by the debenture holders at any meeting called under section 277, 278 or 279.
- (2) A trustee may, in addition to any other rights under the trust deed, seek reimbursement by deducting out of any monies coming into the trustee's hands from the borrower all reasonable costs incurred in explaining the effect of any proposal that the borrower submits to the debenture holders in the circumstances set out in paragraph 273(2)(e).

Duty of auditor to trustee for debenture holders

- 276.** (1) An auditor of a borrower shall, within seven days after furnishing the borrower with any balance sheet, profit and loss account or any report, certificate or other document which he is required by the Companies Act 1965 or by the debenture or trust deed to give to the borrower, send a copy of such balance sheet, profit and loss account, report, certificate or other document by post to every trustee for the holders of debentures of the borrower.
- (2) Where, in the performance of his duties as auditor of a borrower, the auditor becomes aware of any matter which, in his professional opinion, is relevant to the exercise and performance of the powers and duties imposed on the trustee—
- (a) by this Act; or
 - (b) under the trust deed, the auditor shall, as soon as practicable after becoming aware of the matter, report the matter to the borrower and the trustee.
- (3) Where, in the performance of his duties as auditor for the borrower, the auditor becomes aware—
- (a) of any matter which, in his professional opinion, may constitute a contravention of any provision of this Act; or
 - (b) of any irregularities that may have a material effect on the ability of the borrower to repay any amount under the debenture, the auditor shall immediately report the matter to the Commission.
- (4) The auditor shall not, in the absence of proof of malice on his part, be liable to any action for defamation at the suit of any person in respect of any statement made in the circumstances referred to in subsection (1), (2) or (3).
- (5) An auditor who contravenes subsection (1) or (2) commits an offence and shall, on conviction, be liable to a fine not exceeding fifty thousand ringgit.
- (6) An auditor who contravenes subsection (3) commits an offence.

Subdivision 2 – General

Register of debenture holders

- 283.** (1) Subject to subsection (2), every borrower which issues debentures, not being debentures transferable by delivery, shall keep a register of debenture holders at its registered office or at some other place in Malaysia.
- (2) Where the borrower is a company, the borrower shall comply with the provisions of section 70 of the Companies Act 1965 that relate to the obligation to keep a register of debenture holders and a branch register of debenture holders.

continued on next page

Box A1.3 continuation

- (3) The register shall contain particulars of—
- (a) the names and addresses of debenture holders; and
 - (b) the amount of debentures held by them.
- (4) The register shall be open for inspection by registered debenture holders or shareholders of the borrower except when duly closed under subsection (5).
- (5) A register is deemed to be duly closed—
- (a) if it is closed in accordance with the provisions contained in—
 - (i) the constituent documents of the borrower;
 - (ii) the debentures or debenture stock certificates;
 - (iii) the trust deed; or
 - (iv) any other document relating to or securing the debenture; and
 - (b) where it is closed for such periods as is specified in any of the documents mentioned in subparagraphs (5)(a)(i), (ii), (iii) and (iv), provided that such period does not exceed, in the aggregate, thirty days in any calendar year.
- (6) A borrower shall, upon request, supply every registered debenture holder or shareholder of the borrower with a copy of the register of debenture holders, or such part thereof, on the payment of a reasonable sum as may be specified by the borrower.
- (7) The copy of the register of debenture holders referred to in subsection (6) need not include the particulars of any debenture holder other than the name and address of the registered debenture holder and the debentures held by him.
- (8) If inspection is refused, or a copy is refused or not forwarded within a reasonable time after a request has been made pursuant to this section, the borrower and every officer of the borrower who is in default commits an offence and shall, on conviction, be liable to a fine not exceeding one hundred thousand ringgit.
- (9) A borrower issuing debentures may keep at any place outside Malaysia a branch register of debenture holders which shall be deemed to be a part of the borrower's register of debenture holders, and the provisions of Division 4 of Part V of the Companies Act 1965 shall, with such adaptations as are necessary, apply to and in relation to the keeping of a branch register of debenture holders.
- (10) Notwithstanding the provisions of subsections (1) to (9), the Commission may, either on the written application of any borrower referred to in subsection (1) or of its own accord, make an order relieving such borrower from, or approving any variation from, the requirements of this section relating to the maintenance of a register of debenture holders, subject to such terms and conditions as it thinks fit.
- (11) A borrower and every officer of the borrower who is in contravention of subsection (1), (3) or (9) commits an offence and shall, on conviction, be liable to a fine not exceeding one hundred thousand ringgit.

Note: Emphases added by the authors.

Box A1.4 B. Part VIII: Self-Regulatory Organisations⁴⁴

CAPITAL MARKETS AND SERVICES ACT 2007 (Act 671)

As at 28 September 2007

PART VIII

SELF-REGULATORY ORGANISATIONS

322. Interpretation 250
323. Recognition of a self-regulatory organisation 250
324. Duties of a recognised self-regulatory organisation 251
325. Rules of a recognised self-regulatory organisation 252
326. Appointment of directors of a recognised self-regulatory organisation 253
327. Powers to issue directions to a recognised self-regulatory organisation 253
328. Withdrawal of recognition 254
329. Protection for a recognised self-regulatory organisation 255
330. Accounts and reports in respect of a recognised self-regulatory organisation 255
331. Provision of assistance to Commission 256

continued on next page

⁴⁴ Footnote 48.

Box A1.4 continuation

Interpretation

322. For the purposes of this Part, “chief executive”, “director” and “officer” includes any person occupying the position or performing the functions of chief executive, director and officer by whatever name called and “chief executive”, “director” and “officer” shall have the same meaning as in subsection 2(1).

Recognition of a self-regulatory organisation

- 323.** (1) The Commission may, with the concurrence of the Minister, where it thinks appropriate in the public interest or for the protection of investors by notice published in the Gazette, declare a person to be a recognised self-regulatory organisation, subject to such terms and conditions as the Commission thinks fit, if it is satisfied that—
- (a) the person in discharging its obligation under section 324 will not act contrary to the public interest and in particular the interest of investors;
 - (b) the person shall be able to take appropriate action against its members and any person to whom the rules apply to;
 - (c) the person has sufficient financial, human and other resources to carry out its functions;
 - (d) the person is fit and proper and satisfies the criteria or standards referred to in section 64, or any rules of the stock exchange or futures exchange, as the case may be;
 - (e) the person is managed by officers who are fit and proper and who satisfy the criteria or standards referred to in section 65, or any rules of the stock exchange or futures exchange or any applicable guidelines, as the case may be;
 - (f) the person has competent personnel for the carrying out of its functions; and
 - (g) the rules of the person make satisfactory provision—
 - (i) to promote investor protection;
 - (ii) to promote fair treatment of its members and any person who applies for membership;
 - (iii) to exclude a person who is not fit and proper from being its member or being appointed as its chief executive, director or officer;
 - (iv) to promote proper regulation and supervision of its members;
 - (v) to promote appropriate standards of conduct of its members;
 - (vi) to manage any conflict of interest that may arise between its interest and the interest referred to in subsection 324(1);
 - (vii) to ensure that there is a fair representation of members in its governing body;
 - (viii) to ensure that its members and officers duly comply with the securities laws, regulations and guidelines issued by the Commission and where relevant, the rules of the stock exchange, futures exchange, approved clearing house or central depository;
 - (ix) to prevent the usage of any information by its members or officers that may result in such member or officer making an unfair gain;
 - (x) for the expulsion, suspension, disciplining or sanctioning of a member in the event a member contravenes the securities laws, regulations and guidelines issued by the Commission and where relevant, the rules of the stock exchange, futures exchange, approved clearing house or central depository; and
 - (xi) to allow an aggrieved member to appeal against any decision of the recognised self-regulatory organisation.
- (2) The Commission may, in declaring a person to be a recognised self-regulatory organisation, require such person to provide any information to the Commission as the Commission considers necessary.
- (3) A person who—
- (a) with intent to deceive, makes or furnishes; or
 - (b) knowingly authorises or permits the making or furnishing of, any false or misleading statement or report with respect to the information submitted to the Commission referred to in subsection (2) commits an offence and shall, on conviction, be liable to a fine not exceeding three million ringgit or to imprisonment for a term not exceeding ten years or to both.

Duties of a recognised self-regulatory organisation

- 324.** (1) A recognised self-regulatory organisation shall ensure that in exercising any of its powers or in carrying out any of its functions, such power or function shall be exercised or carried out in the public interest having particular regard to the need for the protection of investors.
- (2) A recognised self-regulatory organisation shall immediately notify the Commission if it becomes aware of—
- (a) any matter which adversely affects or is likely to adversely affect the interests of investors; and
 - (b) any contravention by its members of any securities laws.
- (3) Without prejudice to subsection (2), when a recognised self-regulatory organisation expels, or suspends any member, or otherwise disciplines any of its members, it shall, within seven days, give to the Commission in writing the following particulars:
- (a) the name of the member;
 - (b) the reason for and the nature of the action taken;
 - (c) the amount of the fine;
 - (d) the period of suspension, if any; and
 - (e) any other disciplinary action taken.

continued on next page

Box A1.4 continuation

- (4) A recognised self-regulatory organisation shall not make a decision under its rules that adversely affects the rights of a person unless the recognised self-regulatory organisation has given the affected person an opportunity to make representations to the recognised self-regulatory organisation about the matter.
- (5) Notwithstanding the provisions of subsection (4), where the recognised self-regulatory organisation considers that any delay in making the decision is likely to prejudice public interest or necessary for the protection of investors, the recognised self-regulatory organisation may make a decision without giving an opportunity to be heard.

Rules of a recognised self-regulatory organisation

- 325.** (1) No amendments to the rules of a recognised self-regulatory organisation shall have effect unless it has been approved by the Commission under subsection (4).
- (2) Where a recognised self-regulatory organisation proposes to make any amendment to its rules, the recognised self-regulatory organisation shall submit to the Commission—
- the text of the proposed amendment; and
 - an explanation of the purpose of the proposed amendment.
- (3) The Commission shall, within six weeks after the receipt of any proposed amendment under subsection (2), give notice in writing to the recognised self-regulatory organisation that it approves or disapproves of the proposed amendment or any part of the proposed amendment, as the case may be.
- (4) The Commission may, by notice in writing, declare any class of rules of a recognised self-regulatory organisation to be a class of rules whose amendments do not require the approval of the Commission under subsection (3), and accordingly, any amendment to the rules of the recognised self-regulatory organisation that belongs to that class shall, subject to subsections (5) and (6), have effect notwithstanding that they have not been so approved under subsection (3).
- (5) Where the Commission is of the opinion that any amendment to the rules of a recognised self-regulatory organisation made under subsection (4) does not fall within the class of rules declared by the Commission under that subsection as not requiring its approval, the Commission may, after consultation with the recognised self-regulatory organisation, require the recognised self-regulatory organisation to submit such amendment for its approval under subsection (3).
- (6) Notwithstanding the provisions of this section, the Commission may, from time to time, after consultation with the recognised self-regulatory organisation, by written notice require the recognised self-regulatory organisation to amend or supplement any of its rules in such manner and within such period as may be specified in the notice.
- (7) A recognised self-regulatory organisation which contravenes subsection (2) or which contravenes a requirement made under subsection (5) or a written notice made under subsection (6) commits an offence.

Appointment of directors of a recognised self-regulatory organisation

- 326.** (1) No appointment, election or nomination of a director or chief executive of a recognised self-regulatory organisation can be made without the prior approval of the Commission.
- (2) The recognised self-regulatory organisation shall ensure that at least one-third of the number of directors on its board shall be public interest directors in accordance with such criteria as may be specified by the Commission.

Powers to issue directions to a recognised self-regulatory organisation

- 327.** (1) Where the Commission is satisfied that—
- a conflict exists or may come into existence between the interest of a recognised self-regulatory organisation or its members and the interest of the proper performance of the functions or duties conferred by this Act, its rules or any guidelines issued by the Commission pursuant to section 377;
 - such a conflict of interest has occurred or has existed in circumstances that make it likely that the conflict of interest will continue or be repeated; or
 - the recognised self-regulatory organisation has failed to carry out its functions or discharge its duties under subsection 324(1) or its rules or any guidelines issued by the Commission pursuant to section 377, the Commission may serve a written notice on the recognised self-regulatory organisation stating the reasons in support of the ground for the notice and direct the recognised self-regulatory organisation to forthwith take such step as are specified in the notice, including steps in relation to any of its affairs, business or property for the purposes of managing the conflict of interest or the matters occasioning the conflict of interest and the satisfactory carrying out of its functions and satisfactory discharge of its duties.

continued on next page

Box A1.4 continuation

- (2) A notice served under subsection (1) shall take effect immediately.
- (3) A recognised self-regulatory organisation that has been served with a notice under subsection (1) shall not without reasonable excuse; fail to comply with the notice.
- (4) A recognised self-regulatory organisation that has been served with a notice under subsection (1) may appeal against the notice to the Commission not later than fourteen days after the date of service of the notice or such longer period if any, as the Commission may specify in the notice, but the notice shall take effect immediately notwithstanding that the appeal has been or may be made under this subsection.
- (5) Without limiting the generality of subsection (1), the Commission may issue any other direction to a recognised self-regulatory organisation where the Commission thinks necessary in the public interest or for the protection of investors.

Withdrawal of recognition

328. (1) The Commission may, with the concurrence of the Minister, withdraw a recognition given under subsection 323(1) where—
- (a) the recognised self-regulatory organisation has failed to commence operations within six months from the date published in the Gazette under subsection 323(1);
 - (b) the Commission is not satisfied that the recognised self-regulatory organisation is properly performing or is able to perform the functions or duties under its rules or any guidelines issued by the Commission pursuant to section 377;
 - (c) the recognised self-regulatory organisation has breached any term and condition imposed under subsection 323(1);
 - (d) the recognised self-regulatory organisation is in breach of any provisions of the securities laws or any guidelines issued pursuant to section 377 or has failed to comply with any direction by the Commission and where relevant, the rules of the stock exchange, futures exchange, approved clearing house or central depository;
 - (e) the recognised self-regulatory organisation is being wound up or otherwise dissolved;
 - (f) a judgement debt against the recognised self-regulatory organisation has not been satisfied in whole or in part;
 - (g) a receiver, a receiver and manager, or equivalent person has been appointed, in relation to or any property of the recognised self-regulatory organisation;
 - (h) the recognised self-regulatory organisation—
 - (i) on its own accord has applied to the Commission to cease operating as a recognised self-regulatory organisation; or
 - (ii) has been determined by the Commission to have ceased operating as a recognised self-regulatory organisation;
 - (iii) any information provided for the purposes of section 323 was false or misleading in a material particular; or
 - (iv) the recognised self-regulatory organisation has contravened any direction of the Commission issued under section 327.
- (2) A recognition given under subsection 323(1) shall not be withdrawn unless the Commission has notified the recognised self-regulatory organisation of its intention and the reasons for the Commission's action, and give the recognised self-regulatory organisation an opportunity to make representations to the Commission.

Protection for a recognised self-regulatory organisation

329. A recognised self-regulatory organisation, an officer or employee of a recognised self-regulatory organisation or a member of a committee of a recognised self-regulatory organisation shall not be liable for any loss sustained by or damage caused to any person as a result of anything done or omitted by them in the performance in good faith of their powers, functions and duties in connection with the regulatory or supervisory functions of the recognised self-regulatory organisation.

Accounts and reports in respect of a recognised self-regulatory organisation

330. (1) The provisions of Subdivision 6 of Division 4 of Part III shall apply to the appointment, removal and resignation of an auditor and the audit of a recognised self-regulatory organisation's accounts.
- (2) Within three months after the end of each financial year, a recognised self-regulatory organisation shall submit to the Commission a report on the extent to which it has complied with the terms and conditions imposed under subsection 323(1), the requirements imposed on it under this Part and its rules or any guidelines issued by the Commission pursuant to section 377.
 - (3) The Commission shall forthwith send a copy of the report referred to under subsection (2) to the Minister.
 - (4) Upon receipt of the report under subsection (2), the Commission may at any time if it deems it necessary to do so—
 - (a) conduct an audit on the recognised self-regulatory organisation;
 - (b) appoint any independent person to assist the Commission in an audit; and
 - (c) charge the costs of carrying out such audit to the recognised self-regulatory organisation.

continued on next page

Box A1.4 continuation

- (5) The Commission shall as soon as practicable submit to the Minister a copy of the report of the audit conducted by the Commission under subsection (4).

Provision of assistance to Commission

- 331.** (1) A recognised self-regulatory organisation shall provide such assistance to the Commission, or to a person acting on behalf of or with the authority of the Commission, as the Commission or such person reasonably requires, including the furnishing of such returns, and the provision of such information relating to the operations of the recognised self-regulatory organisation or any other information as the Commission or such person may require for the proper administration of the securities laws.
- (2) A person who refuses or fails, without lawful excuse, to assist the Commission or a person acting on behalf of, or authorised by, the Commission, in accordance with subsection (1) commits an offence and shall, on conviction, be liable to a fine not exceeding five hundred thousand ringgit or to imprisonment for a term not exceeding three years or to both.

Guidelines and practice notes of Commission

- 377.** (1) The Commission may, generally in respect of this Act or in respect of any particular provision of this Act, issue such guidelines and practice notes as the Commission considers desirable.
- (2) The Commission may revoke, vary, revise or amend the whole or any part of any guidelines and practice notes issued under this section.
- (3) Subject to this Act or unless the contrary intention is expressly stated, a person to whom the guideline or practice note referred to in subsection (1) apply, shall give effect to such guideline or practice note within such period as may be specified by the Commission.
- (4) Where a person referred to in subsection (3) contravenes or fails to give effect to any guideline or practice note issued by the Commission, the Commission may take any one or more of the actions set out in section 354, 355 or 356 as it thinks fit.

Appendix 1.2 List of Registered Credit Rating Agencies

Table A1. List of Registered Credit Rating Agencies

No.	Name	Contact Details
1.	RAM Rating Services Berhad ^{a, b} (763588-T)	<p>Registered address: Suite 20.01, Level 20 The Gardens South Tower Mid Valley City Lingkarau Syed Putra 59200 Kuala Lumpur</p> <p>Business address: Suite 20.01, Level 20 The Gardens South Tower Mid Valley City Lingkarau Syed Putra 59200 Kuala Lumpur Tel : 603 7628 1000 Fax: 603 7628 1700 Website: www.ram.com.my</p>
2.	Malaysian Rating Corporation ^c Berhad (364803 V)	<p>Registered address: 5th Floor, Bangunan Malaysian Re No. 17, Lorong Dungun Damansara Heights 50490 Kuala Lumpur</p> <p>Business address: 5th Floor, Bangunan Malaysian Re No. 17, Lorong Dungun Damansara Heights 50490 Kuala Lumpur Tel : 603 2092 5398 Fax: 603 2094 9397 (Ratings) 603 2093 9308 (General) Website: www.marc.com.my</p>
<p>^a Rating Agency Malaysia Website. www.ram.com.my ^b Credit rating services were transferred from RAM Holdings Berhad (formerly known as Rating Agency Malaysia Berhad) to RAM Rating Services Berhad on 1 July 2007. ^c Malaysian Rating Corporation Website. www.marc.com.my</p>		

Appendix 1.3 List of Registered Bond Pricing Agency

Bond Pricing Agency Malaysia Sdn Bhd (667403-U)
 Business Address : No.17-8 & 19-8, The Boulevard, Mid Valley City, Lingkarau Syed Putra, 59200 Kuala Lumpur Malaysia
 Tel : 603- 2772 0888 Fax : 603 - 2772 0808
 Website: www.bpam.com.my

Appendix 1.4 List of Guidelines

A. List of Guidelines on the Debt Securities and *Sukuk* Market issued by the Securities Commission Malaysia

1. Guidelines on the Offering of Structured Products - Revised April 2007
2. Practice Note on Registration by the Securities Commission for the Purpose of Acting as a Bond **Trustee**^a - October 2006
3. Guidelines on Registration of Bond Pricing Agencies - January 2006
4. Guidelines on Registration of Credit Rating Agencies - 30 March 2011
5. Guidelines on Registration of an Electronic Broking System - January 2006
6. Guidance Note on the Secondary Trading of Foreign Currency Denominated Debentures and Foreign Currency Denominated Islamic Securities - September 2005
7. Guidelines on Private Debt Securities - August 2011
8. Guidelines on the Offering of Asset-Backed Securities - July 2004
9. Guidelines on Islamic Securities (*Sukuk* Guidelines) - 12 August 2011
10. Guidelines on Dealing in Unlisted Debt Securities by a Universal Broker - October 2002
11. Guidelines on Trust Deeds - 12 August 2011

^a Also applicable to the offering of Islamic Securities.

Note: The list of Guidelines mentioned above is current as at the date of this publication. However, the SC continuously reviews and introduces new guidelines to facilitate the growth of the debt securities and *Sukuk* market. For the latest list, please refer to the SC's website.

B. List of Guidelines Issued by Bank Negara Malaysia and MyClear Relating to the Debt Securities and *Sukuk* market

1. Central Securities Depository and Paying Agency Rules (CSDPAR) - May 2011
2. Operational Framework For MGS Switch Auction - January 2007
3. Guidance Notes on Repurchase Agreement Transactions - July 2006
4. Participation and Operation Rules for Payment and Securities Services - May 2011
5. Operational Procedures for Securities Services - May 2011
6. Operational Procedures for RENTAS - May 2011
7. Guidelines on Regulated Short-Selling of Securities in the Wholesale Money Market - October 2005
8. Guidelines on Standing Facilities - April 2004
9. Guidance Notes on Sell and Buy-back Agreement Transactions - August 2002
10. Guidelines on Securities Borrowing and Lending (SBL) Programme under RENTAS - December 2001

Note: The list of Guidelines mentioned above is current as at the date of this publication. However, Bank Negara Malaysia continuously reviews and introduces new guidelines to facilitate the growth of the debt securities and *Sukuk* market. For the latest list, please refer to Bank Negara Malaysia's and MyClear's website <https://fast.bnm.gov.my/fastweb/public/MainPage.do>

References

- Securities Commission Malaysia (<http://www.sc.com.my/>)
- MALAYSIAN DEBT SECURITIES AND *SUKUK* MARKET 2009
A Guide for Issuers and Investors
A Joint Publication by Bank Negara Malaysia and Securities Commission Malaysia
http://www.sc.com.my/eng/html/bondmkt/MalaysianDebtSecuritiesSukuk_2009.pdf
- Bond Info Hub (Bank Negara Malaysia)
(<http://bondinfo.bnm.gov.my/portal/server.pt?open=514&objID=27275&parentname=MyPage&parentid=0&mode=2>)
- BIS Papers No 26. The corporate bond market in Malaysia.
Muhammad bin Ibrahim and Adrian Wong, Bank Negara Malaysia
(<http://www.bis.org/publ/bppdf/bispap26p.pdf>)
- AsianBondsOnline website (www.asianbondsonline.adb.org)

Prof. Shigehito Inukai
Faculty of Law, Waseda University
1-6-1, Nishiwaseda, Shinjuku-ku, Tokyo, 〒169-8050
Tel & Fax (Direct): + 81-(0)3-3202-2472
Mobile: +81-(0)80-3360-7551
E-Mail: shige.inukai@me.com

Philippine Bond Market Guide

Contents

Acknowledgement	vii
I. Structure, Type, and Characteristics of the Bond Market	1
A. Overview of the market.....	1
B. Types of Securities	1
C. Methods of Issuing Bonds by Type of Securities	2
D. Credit Rating of Bonds.....	4
E. Credit Rating Agencies	4
F. Bond-Related Systems for Investor Protection	5
G. Listing of Securities.....	6
H. Transfer of Interests in Bonds.....	6
I. Governing Laws on Bond Issuance.....	7
J. Definition of Securities	9
K. Self-Governing Rules of the Market	10
L. Bankruptcy Procedures.....	11
M. Meeting of Bondholders.....	13
N. Event of Default	13
O. Marketplace or Facilities Involved in Bond Issuance and Trading.....	14
P. Main Participants in the Market.....	17
Q. Securities Market Professionals.....	20
II. Primary and Secondary Market Regulatory Frameworks	22
A. Philippine Market Regulatory Structure.....	22
B. Regulation of the Philippine Securities Markets.....	23
C. Rules and Regulations on Issuing Debt Instruments	24
D. Rules and Regulations on Buying Debt Instruments and Investment in Debt Securities.....	34
E. Investor Protection	37
F. Regulatory Reporting Requirements	38
G. Reporting Requirements for Cross-Border Deal	44
H. Reporting Requirements for Foreign Currency-Denominated Instruments.....	44

III. Trading of Bonds and Trading Market Infrastructure	45
A. Trading.....	45
B. Bond Repurchase Market.....	46
C. Secondary Market Yields and Transparency in Bond Pricing	47
D. Bond Settlement Infrastructure Diagram (PH:T+3).....	48
E. Bond Transaction Flow Charts.....	49
F. Over-the-Counter Bond Transaction Flow for Foreign Investors.....	51
IV. Possible Impediments and Restrictions	54
A. Taxation.....	54
B. Disclosure and Investor Protection Rules for Issuers	55
C. Underwriting Rules for Financial Institutions.....	56
D. Impediments for Timely Issuance (Suspension Period, Disclosure Requirements, and Others)	56
E. Restriction on Investors (Qualified Institutional Investors and Private Placement)	56
F. Registration Requirements for Foreign Investors.....	57
G. Reporting Requirements (Non-Resident Trade Report, Foreign Currency-Denominated Instruments and Others)	57
H. Non-Resident Requirements (Identification Requirement, Restricted Stocks and Others)	58
I. Restrictions on Over-the-Counter Transactions by Residents and Non-Residents.....	58
J. Regulations on the Credit Rating System	58
K. Utilization of Shelf-Registration System or Medium-Term Notes	58
L. Availability of Information in English.....	59
M. Restrictions in Accounting Standard	59
N. Limited Opportunities to Utilize Bond Holdings and the Repo Market.....	59
O. Degree of Lack of Liquidity in the Secondary Market	59
P. Trade Pre-Matched via Telephone between Custodians for Foreign Institutional Investor	60
V. Description of the Securities Settlement System.....	61
A. Legal Definition of Debt Instruments.....	61
B. Securities Settlement Infrastructure.....	61
VI. Cost and Charging Methods.....	65
A. Average Issuing Costs for Corporate Bonds and Commercial Papers.....	65
B. Average Ongoing Costs for Corporate Bonds and Commercial Papers.....	67
VII. Market Size and Statistics	69
A. Market Size.....	69
B. Size of Local Currency Bond Market in Percentage of Gross Domestic Product.....	71
C. Size of Foreign Currency Bond Market in Percentage of Gross Domestic Product (BIS)	72
D. Size of Foreign Currency Bond Market in US Dollars (Local Sources)	73
E. Domestic Financing Profile.....	74
F. Trading Volume.....	75
VIII. Presence of an Islamic Finance (Sukuk) Market.....	76
IX. History of Debt Market Development	77
A. Total Outstanding Amount of Domestic Government Securities.....	77
B. Historical PDEX Trading Volume in Government Securities and Corporate Bonds	77
C. Major Events that Trigger Market Growth.....	78

X. Next Step ⇒ Future Direction	80
A. Bond Market Liquidity Enhancement.....	80
B. Development of Private Debt Issue Markets.....	82
C. Institutionalization of Hedge and Protection Markets	82
D. Strengthening Clearing and Risk Management Securities and Currencies.....	82
E. Regional Cooperation	83
F. Group of 30 Compliance	84
G. Group of Experts (GoE) Barrier Report Market Assessment – Philippines (April/2010).....	85
References:	88

Boxes, Figures, and Tables

Boxes

Box 1.1	Contents of the Chapters and the Sections items of the Securities Regulation Code.....	7
Box 1.2	Extract from a Prospectus of Corporate Bonds on Meeting of Bondholders	13
Box 1.3	Extract from a Prospectus of Corporate Bonds on an Event of Default.....	14

Figures

Figure 3.1	Bond Settlement Infrastructure Diagram.....	48
Figure 3.2	Bond Transaction Flow for Domestic Trades Government Securities Eligible Dealers Market/Delivery Versus Payment	49
Figure 3.3	Bond Transaction Flow for Domestic Trades Non-Government Securities Eligible Dealers Market/Delivery Versus Payment	51
Figure 3.4	Bond Transaction Flow for Foreign Investors Over-the-Counter Market/Delivery Versus Payment	52
Figure 5.1	Settlement Process for Government Bond Trades Where Both Parties Are Government Securities Eligible Dealers	63
Figure 5.2	Settlement Process for All Corporate Bond Trades and Government Bond Trades Where One or Both Parties Are Not Government Securities Eligible Dealers	64
Figure 7.1	Government Securities Primary versus Secondary Market Trading Volume (PHP trillion).....	71

Tables

Table 2.1	Extract on Exemption from Disclosure Requirements-Related Descriptions from the Securities Regulation Code	24
Table 2.2	Securities Regulation Code Chapter V: Reportorial Requirements	38
Table 2.3	Securities Regulation Code Rule 17.1 Reportorial Requirements (Signed Version and Draft Version).....	40
Table 3.1	Philippine Dealing Exchange Inter-Professional Repurchase Agreements (IP-Repo) Trading Volume (PHP billions)	47
Table 6.1	Registration Statement Filing Fee.....	65
Table 6.2	Fees to Underwriters or Selling Agent	66
Table 6.3	Trustee Fees	66
Table 6.4	Other Fees	67
Table 6.5	Broker's Commissions	68
Table 6.6	Private Registry Transfer Fees	68
Table 7.1	Capital Market (Direct Financing) versus Bank Loans (Indirect Financing) (PHP billion).....	69

Table 7.2	Fixed-Income Instruments per Issuer Type and Outstanding Amount (PHP billion)	69
Table 7.3	Bonds and Corporate Papers Issued by Corporations Registered under the Securities and Exchange Commission.....	70
Table 7.4	Domestic Financing versus International Financing (PHP billion)	71
Table 7.5	Size of Local Currency Bond Market, Percentage Gross Domestic Product (Local Sources) (USD billion)	71
Table 7.6	Foreign Currency Bonds to Gross Domestic Product Ratio (USD billion)	72
Table 7.7	Foreign Currency Bonds Outstanding (Local Sources) (USD billion)	73
Table 7.8	Domestic Financing Profile (USD billion)	74
Table 7.9	Trading Volume (USD billion)	75
Table 9.1	Total Outstanding Amount of Domestic Government Securities (PHP billion).....	77
Table 9.2	Trading Volume in Government Securities and Corporate Bonds, 2005–2010.....	77
Table 10.1	Group of Thirty Compliance	84
Table 10.2	Summary of Barriers Market Assessment – Philippines (April 2010).....	85

Acknowledgement

The Asian Development Bank (ADB) Team, comprising Satoru Yamadera (Economist, ADB Office of Regional Economic Integration, - September 2011), Seung Jae Lee (Principal Financial Sector Specialist), Shinji Kawai (Senior Financial Sector Specialist, Banking), Shigehito Inukai (ADB consultant), Taiji Inui (ADB consultant), and Matthias Schmidt (ADB consultant), The ADB Team would also like to express our sincere gratitude to the Philippine Working Group (PWG). The PWG was composed of public and private sector representatives. The public sector was represented by the Department of Finance, Bangko Sentral ng Pilipinas, the Securities and Exchange Commission, and the Bureau of Internal Revenue. Private sector representation consisted of the Bankers Association of the Philippines and the Philippine Dealing System Group of Companies. The PWG included National Members and Expert Institutions and was created to provide responses to the original questionnaires prepared by the ADB Team, and its members gave their valuable comments and reviewed the draft of the Philippine Market Guide.

The ADB Team also would like to express special thanks to Citibank, Deutsche Bank AG, Hongkong Shanghai Banking Corporation, J.P. Morgan Chase, and State Street as International Experts for their contribution to provide information from their own market guides, as well as their valuable expertise. Because of their cooperation and contribution, the ADB Team started the research on solid ground.

Last, but not least, the ADB Team would like to thank all the interviewees who gave their comments and responses to questions that were raised during the market consultations.

It should be noted that any part of this report does not represent the official views and opinions of any institution which participated in this project as members and experts of the ASEAN+3 Bond Market Forum.

The ADB Team has sole responsibility for the contents of this report.

February 2012

Asian Development Bank (ADB) Team

List of Interviewees:

Manila, 19 May 2011

Sycip, Salazar, Hernandez and Gatmaitan
Hongkong Shanghai Banking Corporation Philippines
Deutsche Bank AG, Manila Branch
Philippine Dealing and Exchange Corporation (PDEX)

Manila, 20 May 2011

ING, Manila/Bankers Association of the Philippines (BAP)
Bangko Sentral ng Pilipinas (BSP)

I. Structure, Type, and Characteristics of the Bond Market

A. Overview of the market

The Philippine domestic bond market consists of short- and long-term bonds, mainly issued by the national government. The Philippine bond market is dominated mainly by Treasury notes and bonds. Although the size of the Philippine corporate bond market is still small relative to government bonds, it has been growing rapidly over the years.

B. Types of Securities

1. By Issuer Category

a. Issued by the National Government through the Bureau of the Treasury (BTr)

- i. Treasury bills (fixed-rate)
- ii. Treasury bonds (fixed-rate coupon-bearing and zeroes)
- iii. Retail treasury bonds (RTBs, fixed-rate coupon-bearing)
- iv. Multi-currency retail treasury bonds (MRTBs, fixed-rate coupon-bearing)
- v. Dollar-linked peso notes (fixed-rate)

b. Issued by the National Government through Other Entities

- i. Debt securities issued by government-owned and -controlled corporations (GOCCs)¹
- ii. Debt securities issued by government agencies

c. Issued by Private Entities²

- i. Straight bonds (corporate notes and bonds)
- ii. Zero-coupon notes and bonds
- iii. Floating-rate corporate notes
- iv. Bank-unsecured subordinated debt capital securities

¹ A list of GOCCs can be found on the website of the Commission on Audit: <http://www.coa.gov.ph/Links/links-goccs.asp>

² Private entities include financial institutions, local corporations, multilateral development banks (MDBs), and non-MDB offshore borrowers.

- v. Certificates of deposit
- vi. Commercial paper (CP), which is an evidence of indebtedness of any person with a maturity of less than 365 days.
- vii. Long-term commercial paper (LTCP), which is an evidence of indebtedness of any person with a maturity of more than 365 days. The term shall include, but not limited to, bonds and notes.
- viii. Acceptances (trade acceptances and bankers acceptances)
- ix. Securitized bonds

2. By Listing Status

a. Debt Securities Listed on the Philippine Dealing and Exchange System

There are three types of government securities issued by the national government through the Bureau of the Treasury (BTr): Treasury bonds, RTBs, and MRTBs.

b. Non-Listed Debt Securities Traded Over the Counter

3. By Offering Type

a. Public Offering. A public offering is sold to both non-qualified and qualified investors. Securities offered are typically registered with the Securities and Exchange Commission (SEC), unless qualified for exemption under the *Securities Regulation Code*.

b. Private Placement. Private placement is sold to a limited number of investors (currently set at 19) and typically to qualified investors only.

4. By Currency of Instruments

- a. Philippine Peso
- b. United States (US) Dollar
- c. Euro

C. Methods of Issuing Bonds by Type of Securities

The methods of bond issuance are different from one bond issuer to another. In the case of government bonds, the method of issuance also depends on whether it is a regular or special issuance.

1. Bonds Issued by Government

a. Regular Issuances

The national government, through the BTr, issues peso-denominated government securities through the following methods of origination as may be prescribed in an offering document:

- i. Auction is a mode of sale or offering government securities participated by accredited Government Securities Eligible Dealers (GSEDs). GSEDs submit their bids electronically through the auction front-end system of the BTr called the Automated Debt Auction Processing System (ADAPS). Submitted bids are evaluated for acceptance, award, or rejection by the Auction Committee composed of the secretary of the Department of Finance (DOF) as chairman;

the treasurer of the Philippines as vice chairman; the deputy treasurer of the Philippines as member and executive director; and an assistant secretary of the DOF, the deputy governor of the Bangko Sentral ng Pilipinas (BSP), the head of Treasury of the BSP, and the head of Market Regulation Department of the SEC as members.

A regular division of the BTr provides administrative support to the Auction Committee.

- ii. The tap method represents the sale of government securities (GS) exclusively to GSEDs whenever there is an acute shortage of securities in the market. The issuance of GS through the tap method is conducted by the BTr.
- iii. The OTC method represents the sale of government securities to tax-exempt institutions, GOCCs, and local government units (LGUs). The issuance of GS through the OTC Method is conducted by the BTr.

All types of securities may be issued or floated through any of the above methods of origination subject to legal limits applicable to a particular class of investors.

b. Special Issuances

Philippine peso-denominated RTBs are targeted for retail investors who can invest a minimum of PHP5,000. RTBs are intended to develop and provide safe investments to small savers. Unlike regular Treasury bonds, RTBs pay fixed quarterly coupon. Interest income per coupon is subject to final withholding tax, currently at 20%, as prescribed by the *1997 Tax Code*, as amended.

US dollar- and euro-denominated MRTBs are targeted for overseas Filipinos and their qualified beneficiaries.³ MRTBs are issued within Philippine jurisdiction. Apart from overseas Filipinos, Foreign Currency Deposit Units are allowed to invest in MRTBs under certain preferential tax application pursuant to the *1997 Tax Code* and tax rulings of the Bureau of Internal Revenue (BIR). Interest income per coupon is also subject to final withholding tax, which is currently at 20%, as stipulated under the *1997 Tax Code*, as amended. The issuer assumes the corresponding final withholding tax on interest income per coupon for overseas Filipino holders or their qualified beneficiaries.

As MRTBs are structured to be transferable across investors of different tax categories, the BTr employs an electronic tax-tracking system to determine investors' holding period for purposes of computing the correct amount of final tax due from investors.

2. Bonds Issued by Government-Owned and -Controlled Corporations and Government Agencies

The authority of GOCCs and government agencies to issue debt securities is subject to the statute or charter of the GOCC or government agency, and to presidential full powers or special authority whenever a sovereign guarantee is required, executed by the president of the Philippines.

Bonds are typically priced and allocated through auction to participating dealers.

³ Overseas Filipinos are Filipino citizens working outside the Philippines under any form of contractual relation.

The terms and conditions of the issuance are prescribed in an offering document or prospectus issued by the GOCC or government agency.

3. Bonds Issued by Private Entities

Private entities generally adopt one of the following methods to issue corporate bonds:

- a. **Public Offer.** Public offer of securities intended for sale to both the retail and qualified investor markets; or
- b. **Private Placement.** Private placement of securities intended to be sold to a limited number of investors, typically qualified investors.

D. Credit Rating of Bonds

As a general rule under *Republic Act (RA) No. 8799*, or the *Securities Regulation Code (SRC) Rule 12.1-6*, a credit rating from an SEC-accredited CRA is required to issue corporate bonds and CPs, except: 1) when the issuance amounts to not more than 25% of the issuer's net worth; or 2) where there is an irrevocable committed credit line with a bank covering 100% of the proposed issuance. Credit rating requirements are applicable to CPs issued by corporations to the public, the offer or sale of which is to be registered under the SRC. Credit rating requirements do not apply to government and government-guaranteed debt securities.

Under the amended Philippine Dealing and Exchange Corporation (PDEX) Rules for the fixed-income securities market, the issuer of the securities seeking to be listed on PDEX must be rated by a CRA duly recognized by the applicable governmental authorities at the time of listing, provided that if such securities are subordinated, such issuer shall also have the securities rated at the time of listing.

E. Credit Rating Agencies

1. Philippine Rating Service Corporation

The Philippine Rating Service Corporation (PhilRatings)⁴ is the only domestic credit rating agency (CRA) in the Philippines accredited by both the BSP and the SEC. The rating agency is also an affiliate of Standard and Poor's.

⁴ PhilRatings started providing credit rating services in 1985. It is accredited by both the Bangko Sentral ng Pilipinas (BSP) and the Securities and Exchange Commission (SEC). It is 70%-owned by Motan Corporation and 30%-owned by CIBI Foundation, Inc. It was initially part of a company known as the Credit Bureau, Inc. (CIBI) which was established by the SEC, and the Financial Executives Institute of the Philippines (FINEX) in 1982 to serve as a third-party source of business and credit information. The credit rating function in the Philippines started in 1985 when a company then known as Credit Information Bureau, Inc. (CIBI) began rating commercial papers as a requirement for registration with SEC. BSP has approved the recognition of PhilRatings as a domestic CRA for bank supervisory purposes. PhilRatings was also accredited by the SEC as a CRA after compliance with the requirements under SRC Rule 12.1 subject to faithful compliance with the reportorial and other requirements of said rule, applicable laws, circulars, rules and regulations and to further orders of the SEC. PhilRatings is a domestic external credit assessment institution (ECAI) which can rate domestic debt issuances in relation to BSP's implementing guidelines of Basel II. A basic profile of PhilRatings can be found in the website: <http://www.philratings.com>

2. Credit Rating and Investors Services Philippines

Credit Rating and Investors Services Philippines (CRISP),⁵ a domestic CRA in the Philippines, was launched and received its accreditation as a CRA from the SEC in 2008.

F. Bond-Related Systems for Investor Protection

1. Reportorial and Disclosure Requirements

The SRC and its Implementing Rules and Regulations (IRR or SRC Rules)⁶ prescribe reportorial requirements for corporate issuers of registered securities, consisting of periodic and current reports. Periodic reports are annual and quarterly reports, which contain information on the operation of the business and the financial condition of an issuer for the covered period.

In any event or material fact that may affect investors' decisions in relation to these securities, an issuer is required to make a full, accurate and timely disclosure to the public through the news media. An issuer should also make a disclosure to the exchange within 10 minutes after occurrence of the event, and prior to its release, to the public through the news media, furnishing a copy of the same report to the SEC. Also, an issuer is required to report the event to the SEC within 5 days after its occurrence, unless a substantially similar information has been previously reported to the SEC.

Issuers of corporate securities listed on PDEX are bound by continuing disclosure obligations.⁷ They are required to submit periodic reports such as financial statements, and disclose material information that may affect investors' decision to buy, sell, or hold listed securities.

2. Trustee System

After the appointment of a trustee bank, a registration statement shall be submitted to the SEC. The registration statement shall include a description of the circumstances under which the trustee is required to act on behalf of the bondholders, and a copy of the trust indenture or trust agreement executed by and between the company and the trustee.

Securities regulations require an issuer of registered debt securities to appoint a trustee bank that shall act on behalf of bondholders. Under current securities

⁵ A basic profile of Credit Rating and Investors Services Philippines (CRISP) can be found in: <http://crisp.com.ph>

⁶ Securities and Exchange Commission (SEC). 2004. *Amended Implementing Rules and Regulations (IRR) of the Securities Regulation Code (SRC)*. <http://www.sec.gov.ph/irr/AmendedIRRfinalversion.pdf>; SEC. 2005. *Draft version of the "Revised Implementing Rules and Regulations (IRR) of The Securities Regulation Code (SRC)"* <http://www.sec.gov.ph/src/Draft2%20SRC%20IRR.2011.pdf>; SEC. 2005. "Part I: General Financial Reporting Requirements," *SRC Rule 68, as Amended*. <http://www.sec.gov.ph/src/SRC%20rule%2068%20as%20amended.pdf>; SEC. 2005. "Part 2: Additional Requirements for Issuers of Securities to the Public," *SRC Rule 68, as Amended*. <http://www.sec.gov.ph/src/SRC%20rule%2068%20as%20amended.pdf>; SEC. 2005. *Notice of Amendments to SRC Rules 68 and 68.1*, see the following website: <http://www.sec.gov.ph/irr/amended/Notice-Rules-68&68.1-2005.pdf>; SEC. 2005. "Rules and Regulations Covering Form and Content of Financial Statements," *SRC Rule 68*. <http://www.sec.gov.ph/irr/amended/RULE68-2005.pdf>; (Rules-68-1) "Special Rule on Financial Statements of Reporting Companies Under Section 17.2 of the Securities Regulation Code," *SRC Rule 68-1*. <http://www.sec.gov.ph/irr/amended/RULE68.1-2005.pdf>

⁷ Submitted disclosures are published on the PDEX website, www.pdex.com.ph

regulations, there is no prescribed standard trust agreement, and specific provisions may differ across different bond issuances.

A trustee shall be responsible for performing, among others, the following duties for the benefit of bondholders:

- (a) Monitor compliance by the issuer with its obligations under the trust agreement.
- (b) Report regularly to bondholders any non-compliance by the issuer to the trust agreement and any development with respect to the issuer that adversely affects the interest of bondholders, and advise bondholders of the course of action that they may take to protect their interest.
- (c) Act on behalf of bondholders including calling for and/or attending meetings of bondholders.

G. Listing of Securities

Philippine-peso denominated Treasury bills, notes and bonds, as well as US-dollar denominated RTBs, are listed on PDEX for secondary trading. GOCC and private fixed-income securities offered to public investors may also be listed on PDEX. Listing of fixed-income securities on PDEX is subject to admission rules, conventions, and guidelines of PDEX.

H. Transfer of Interests in Bonds

1. Register of Bondholders

An issuer of a corporate bond shall cause the registrar duly licensed by the SEC and/or BSP to keep the Register of Bondholders in electronic or physical form. The names and addresses of bondholders and particulars of the bonds they hold, as well as all transfers of bonds, shall be entered into the register.

As required by Circular No. 428-04 issued by the BSP,⁸ the registrar shall send each bondholder a written statement of registry holdings at least quarterly. The cost for such shall be at the issuer's expense, unless specified in the terms and conditions of the bonds. The registrar shall also send a written advice confirming every receipt or transfer of the bonds effected in the registrar's system, at the relevant bondholder's expense. The statement of registry holdings shall serve as the confirmation of ownership of the bondholder as of the date thereof.

Bondholders shall bear costs related to any requests for certification, reports, and other documents from the registrar.

(i) A transfer between bondholders of different tax status occur on a day which is not an interest payment date

(ii) Tax-exempt entities trading with nontax-exempt entities are treated as nontax-exempt entities for the interest period within which such transfer occurred.

⁸ Bangko Sentral ng Pilipinas. 2004. BSP Circular No. 428-04. <http://www.bsp.gov.ph/regulations/regulations.asp?id=161>

Government securities issued by the national government through the BTr are recorded with the Registry of Scripless Securities (RoSS). RoSS is an electronic book-entry system operated by the BTr, which serves as the final and official record of ownership or interest in government securities. Debt securities issued by GOCCs may also be recorded in RoSS. Appropriate agreements are executed between the issuer-GOCC and BTr on the use of the registry system.

2. Transfers and Tax Status

Transfer provisions vary across different types of bonds, as defined in the terms and conditions for each bond issuance. Currently, Philippine-peso denominated government securities may only be transferred to investors belonging to the same tax category.

In 2010, the BTr issued MRTBs, which may be transferred between and among investors of different tax categories. Transfers of corporate securities across different tax categories are currently limited to coupon dates, under the following treatment:

- (i) Tax-exempt entities trading with nontax-exempt entities are treated as nontax-exempt entities for the interest period within which such transfer occurred, or
- (ii) Tax-exempt holders trading across tax categories are considered as tax withheld.

I. Governing Laws on Bond Issuance

The issuance of bonds in the Philippines is governed by the SRC,⁹ which is implemented by the SEC. Generally, all publicly offered securities must be registered with the SEC. Exemptions are granted, among others, to securities issued by the national government, the BSP, LGUs, banks (excluding their own shares), and any foreign government that has diplomatic relations with the Philippines.

Exemptions are also granted to securities issued only to primary institutional lenders or qualified buyers as defined in Sections 9 and 10 of the SRC and the SRC IRR.

Box 1.1 Contents of the Chapters and the Sections items of the Securities Regulation Code

[REPUBLIC ACT NO. 8799] THE SECURITIES REGULATION CODE (SRC)

CHAPTER I - Title and Definitions

Sec. 2. Declaration of State Policy.

Sec. 3. Definition of Terms.

CHAPTER II - Securities and Exchange Commission

Sec. 4. Administrative Agency.

Sec. 5. Powers and Functions of the Commission.

Sec. 6. Indemnification and Responsibilities of Commissioners.

Sec. 7. Reorganization.

CHAPTER III - Registration of Securities

Sec. 8. Requirement of Registration of Securities.

continued on next page

⁹ Republic of the Philippines. Securities and Exchange Commission (SEC). 2000. *Republic Act 8799* (Securities Regulation Code). <http://www.sec.gov.ph/index.htm?src/index>

Box 1.1 continuation

- Sec. 9. Exempt Securities
- Sec. 10. Exempt Transactions.
- Sec. 11. Commodity Futures Contracts.
- Sec. 12. Procedure for Registration of Securities.
- Sec. 13. Rejection and Revocation of Registration of Securities.
- Sec. 14. Amendments to the Registration Statement.
- Sec. 15. Suspension of Registration.
- CHAPTER IV - Regulation of Pre-Need Plans
 - Sec. 16. Pre-Need Plans.
- CHAPTER V - Reportorial Requirements
 - Sec. 17. Periodic and Other Reports of Issuers.
 - Sec. 18. Reports by Five per centum (5%) Holders of Equity Securities.
- CHAPTER VI - Protection of Shareholder Interests
 - Sec. 19. Tender Offers.
 - Sec. 20. Proxy Solicitations.
 - Sec. 21. Fees for Tender Offers and Certain Proxy Solicitations.
 - Sec. 22. Internal Record Keeping and Accounting Controls
 - Sec. 23. Transactions of Directors, Officers and Principal Stockholders.
- CHAPTER VII - Prohibitions on Fraud, Manipulation and Insider Trading
 - Sec. 24. Manipulation of Security Prices; Devices and Practices.
 - Sec. 25. Regulation of Option Trading.
 - Sec. 26. Fraudulent Transactions.
 - Sec. 27. Insider's Duty to Disclose When Trading.
- CHAPTER VIII - Regulation of Securities Market Professional
 - Sec. 28. Registration of Brokers, Dealers, Salesmen and Associated Persons.
 - Sec. 29. Revocation, Refusal or Suspension of Registration of Brokers, Dealers, Salesmen and Associated Persons.
 - Sec. 31. Development of Securities Market Professionals
- CHAPTER IX - Exchanges and Other Securities Trading Markets
 - Sec. 32. Prohibition on Use of Unregistered Exchange; Regulation of Over-the-Counter Markets.
 - Sec. 33. Registration of Exchanges.
 - Sec. 34. Segregation and Limitation of Functions of Members, Brokers and Dealers
 - Sec. 35. Additional Fees of Exchanges.
 - Sec. 36. Powers with Respect to Exchanges and Other Trading Market.
 - Sec. 37. Registration of Innovative and Other Trading Markets.
 - Sec. 38. Independent Directors.
- CHAPTER X - Registration, Responsibilities and Oversight of Self-Regulatory Organizations
 - Sec. 39. Associations of Securities Brokers, and Dealers, and Other Securities Related Organizations.
 - Sec. 40. Powers with Respect to Self-Regulatory Organizations.
- CHAPTER XI - Acquisition and Transfer of Securities and Settlement of Transactions in Securities
 - Sec. 41. Prohibition on Use of Unregistered Clearing Agency.
 - Sec. 45. Pledging a Security or Interest Therein.
 - Sec. 42. Registration of Clearing Agencies.
 - Sec. 43. Uncertificated Securities.
 - Sec. 44. Evidentiary Value of Clearing Agency Record.
 - Sec. 46. Issuer's Responsibility for Wrongful Transfer to Registered Clearing Agency
 - Sec. 47. Power of the Commission With Respect to Securities Ownership.
- CHAPTER XII - Margin and Credit
 - Sec. 48. Margin Requirements.
 - Sec. 49. Restrictions on Borrowings by Members, Brokers, and Dealers.
 - Sec. 50. Enforcement of Margin Requirements and Restrictions on Borrowing.
- CHAPTER XIII - General Provisions
 - Sec. 51. Liabilities of Controlling Persons, Aider and Abettor and Other Secondary Liability.
 - Sec. 52. Accounts and Records, Reports, Examination of Exchanges, Members, and Others.
 - Sec. 53. Investigations, Injunctions and Prosecution of Offenses.
 - Sec. 54. Administrative Sanctions.
 - Sec. 55. Settlement Offers.
 - Sec. 56. Civil Liabilities on Account of False Registration Statement.
 - Sec. 57. Civil Liabilities Arising in Connection With Prospectus, Communications and Reports.
 - Sec. 58. Civil Liability For Fraud in Connection With Securities Transactions.
 - Sec. 59 Civil Liability For Manipulation of Security Price.

continued on next page

Box 1.1 continuation

- Sec. 60. Civil Liability With Respect to Commodity Futures Contracts and Pre-need Plans.
- Sec. 61. Civil Liability on Account of Insider Trading.
- Sec. 62. Limitation of Actions.
- Sec. 63. Amount of Damages to be Awarded.
- Sec. 64. Cease and Desist Order.
- Sec. 65. Substituted Service Upon the Commission.
- Sec. 66. Revelation of Information Filed with the Commission.
- Sec. 67. Effect of Action of Commission and Unlawful Representations with Respect Thereto.
- Sec. 68. Special Accounting Rules.
- Sec. 69. Effect on Existing Law.
- Sec. 70. Judicial Review of Commission Order.
- Sec. 71. Validity of Contracts.
- Sec. 72. Rules and Regulations; Effectivity.
- Sec. 73. Penalties.
- Sec. 74. Transitory Provisions.
- Sec. 75. Partial use of Income.
- Sec. 76. Repealing Clause.
- Sec. 77. Separability Clause
- Sec. 78. Effectivity.

IMPLEMENTING RULES AND REGULATIONS OF THE SECURITIES REGULATION CODE (SRC IRR)

Source: Securities and Exchange Commission.

A credit rating from PhilRatings, CRISP, or any SEC-accredited CRA is required to issue corporate bonds and CPs. Generally, foreign-denominated debt instruments must be registered with the BSP.

For government securities, the following statutes or laws govern bond issuance of the Philippine national government:

1. *RA No. 245, as amended (An Act Authorizing the Secretary of Finance to Borrow to Meet Public Expenditures Authorized by Law and for Other Public Purposes)*
2. *RA 1000, as amended (An Act Authorizing the President of the Philippines to Issue Bonds to Finance Public Works Projects for Economic Development, Authorized by Law, and for Other Purposes)*
3. *RA 4860, as amended (Foreign Borrowings Act)*
4. *RA 8182 (Official Development Assistance Act)*
5. *RA 7653 (New Central Bank Act)*, which mandated the phase out of fiscal agency functions of the BSP to the DOF pertaining to the issue and placement of government securities; servicing and redemption of public debt; and management of the Securities Stabilization Fund.
6. *RA 713 (Custody of Sinking Funds)*
7. *Executive Order No. 449, Series 1997 (Reorganization of the Bureau of the Treasury)*

J. Definition of Securities

Under the Section 3 of the SRC, securities are defined as shares, participation, or interests in a corporation, a commercial enterprise, or a profit-making venture,

which are evidenced by a certificate, contract, or an instrument either in written or electronic form. These include:

1. Shares of stock, bonds, debentures, notes, evidences of indebtedness, and asset-backed securities;
2. Investment contracts, certificates of interest or participation in a profit-sharing agreement, and certificates of deposit for a future subscription;
3. Fractional undivided interests in oil, gas, or other mineral rights;
4. Derivatives like option and warrants;
5. Certificates of assignments, certificates of participation, trust certificates, voting trust certificates, or similar instruments;
6. Proprietary or non-proprietary membership certificates incorporations; and
7. Other instruments as may be determined in the future by the SEC.

The *PDEX Rules for the Fixed-income Securities Market, as Amended* (PDEX Rules)¹⁰ defines securities as fixed-income securities, including government securities.

K. Self-Governing Rules of the Market

Under the Section 39 of the SRC, the SEC granted PDEX the license to act as a self-regulatory organization (SRO) for the inter-dealer, inter-professional, and public markets. As an SRO, PDEX has adopted the PDEX Rules to govern all transactions dealt on the PDEX trading platform for fixed-income securities.

In July 2006, SEC formally recognized PDEX as a SRO in the inter-dealer market, and is thus vested with the responsibility of formulating the requisite market rules, undertaking surveillance, and enforcing compliance in the inter-dealer market.

The SEC issued Memorandum Circular No.14, s. 2006 on “Rules Governing the OTC Markets”¹¹ which included government securities; it directed that “no broker or dealer shall participate in an OTC market unless said broker or dealer is a member of an SRO that has been registered with the Commission for the purpose of regulating and supervising the activities of the broker or dealer in an OTC market.”

In November 2007, the SEC expanded the SRO registration of PDEX to cover the inter-professional market.

In January 2008, PDEX was granted an SRO status for the OTC market which resulted in the coverage of all government securities (GS) trading activities. To date, it remains the only SRO for the OTC market in GS.

Trading Participants, Non-Trading Participants and related parties under the membership of other SROs may be admitted to the PDEX markets under the applicable PDEX Rules below. As a reference, according to PDEX Rules;

¹⁰ Philippine Dealing and Exchange Corporation. 2009. *The PDEX Rules for the Fixed-income Securities Market, as Amended* (PDEX Rules). <http://pdex-hosting.bayandsl.ph/Public%20Market%20Rules%20-%20Revised%207-17-2009.pdf>

¹¹ Footnote 6. *SEC Memorandum Circular No. 14, Series of 2006*, “Rules Governing the Over-the-Counter (OTC) Market.” <http://www.sec.gov.ph/circulars/cy,2006/sec-memo-14,s2006.pdf>

Rule 1.3-1.d: All Trading Participants should: in cases where the applicant is a member of another self-regulatory organization (SRO) and/or duly accredited broker/dealer association, have a certificate from such other SRO and/or broker/dealer association certifying its good standing thereat and absence of derogatory record for three (3) years immediately prior to the application with PDEX;

Rule 1.7.b: The Associated Person: A Trading Participant shall appoint an Associated Person who shall: If the Trading Participant is a Trading Participant of another SRO and the Associated Person is such officer even with respect to such other SRO, then they must be in good standing at such other SRO;

Rule 3.6.1: Trades with Non-Trading Participants: Dealing Participants may deal directly with Non-Trading Participants upon submission to PDEX of the necessary documents as required by and in such form as may be prescribed by PDEX, provided that, if the Non-Trading Participant is a SEC-registered broker or dealer, the same and the SRO of which it is a member shall comply with the requirements of the OTC Rules.¹²

L. Bankruptcy Procedures

The *Financial Rehabilitation and Insolvency Act of 2010* (FRIA)¹³ and the *Civil Code of the Philippines* (Civil Code) govern the bankruptcy procedures in the country. The Supreme Court will soon issue the implementing rules of FRIA.

FRIA was passed into law on 18 July 2010. It repealed the country's 101-year-old *Insolvency Law* (Act 1956), which was enacted in 1909. FRIA provides for three different modes of rehabilitating an insolvent corporate debtor, namely: (a) court-supervised rehabilitation, (b) pre-negotiated rehabilitation, and (c) out-of-court or informal restructuring or rehabilitation.

In a court-supervised rehabilitation proceeding, the court appoints a receiver and determines which claims against the debtor are valid. A rehabilitation plan is to be agreed upon by the debtor and creditors representing more than 50% of the claims of each class of creditors. If the plan is not finalized or approved by the court, the debtor will be liquidated. During the pendency of the proceedings, all claims against the debtor are suspended, and taxes, as well as fees due from the debtor to the government, are deemed waived. The amount of debt reduced or forgiven will not be subject to tax.

In a pre-negotiated rehabilitation, a debtor seeks court approval of a rehabilitation plan it previously contracted with creditors, representing at least two-thirds of its total liabilities, and at least 67% and 75% of its secured and unsecured obligations, respectively. Claims against the debtor are suspended while the proceedings are pending in court.

In an out-of-court restructuring, the debtor and creditors, representing at least 85%

¹² Footnote 11.

¹³ Republic of the Philippines. 2010. *Financial Rehabilitation and Insolvency Act (FRIA) of 2010*. http://www.lawphil.net/statutes/repacts/ra2010/ra_10142_2010.html

of the debtor's total liabilities and at least 67% of its secured obligations and 75% of its secured obligations, are to agree on a restructuring or rehabilitation plan. This plan becomes binding on the contracting parties, as well as on other creditors of the debtor. During negotiations, creditors holding more than 50% of the total claims may approve a standstill of up to 120 days.

The FRIA does not cover banks, insurance companies and pre-need companies as other laws and regulations govern these entities. However, it provides for the liquidation of insolvent juridical debtors. The debtor can initiate voluntary liquidation through a verified petition or a verified motion in court-supervised or pre-negotiated rehabilitation proceedings.

Rehabilitation proceedings may also be transformed into liquidation proceedings in the following situations:

- (a) When the rehabilitation court finds that the debtor is insolvent and there is no substantial likelihood for the debtor to be successfully rehabilitated;
- (b) When the rehabilitation plan is not confirmed by the rehabilitation court within 1 year from filing of the petition;
- (c) When the rehabilitation proceedings are terminated due to failure or dismissal of the rehabilitation petition for reasons other than technical grounds; or
- (d) At any time upon the recommendation of the rehabilitation receiver that the rehabilitation of the debtor is not feasible.

Involuntary liquidation is initiated by three or more creditors whose aggregate claims amount to at least PHP1 million, or at least 25% of the subscribed capital stock or partners' contribution, whichever is higher, also through a verified petition or motion in a court-supervised or pre-negotiated rehabilitation proceedings.

FRIA has special provisions for the liquidation of a securities-market participant. It recognizes the power of a regulatory agency or an SRO to liquidate trade-related claims of clients or customers of a securities-market participant, which, for purposes of investor protection, are deemed to have absolute priority over all other claims of whatever nature or kind insofar as trade-related assets are concerned. Trade-related assets include cash, securities, trading rights, and other assets owned and used by a securities-market participant in the ordinary course of its business.

For insolvent individual debtors, the FRIA provides for:

- (a) The suspension of payments when the debtor possesses sufficient properties to cover all his debts, but foresees the impossibility of meeting them when they respectively fall due;
- (b) Voluntary liquidation initiated by the debtor who does not have sufficient properties to cover his liabilities and owes debts exceeding PHP500,000; and
- (c) Involuntary liquidation initiated by creditors with claims aggregating at least PHP500,000.

FRIA requires that the liquidation plan and its implementation shall ensure that the concurrence and preference of credits, as enumerated in the Civil Code and other relevant laws, shall be observed, unless a preferred creditor voluntarily waives his preferred right. Credits for services rendered by employees or laborers to the debtor shall enjoy first preference under Article 2244 of the Civil Code, unless the claims constitute legal liens under Article 2241 and Article 2242 of the Civil Code.

The “Asia-Pacific Restructuring and Insolvency Guide 2006” provides a guide to explain the restructuring and insolvency frameworks of Asia-Pacific countries.¹⁴

M. Meeting of Bondholders

The following is an extract taken from a prospectus of corporate bonds in the Philippines for reference purposes.

Box 1.2 Extract from a Prospectus of Corporate Bonds on Meeting of Bondholders

The Trustee may at any time call a meeting of the bondholders, on its own accord or upon the written request by the issuer or majority bondholders, for purposes of taking any actions authorized under the Trust Indenture or Trust Agreement.

1. Notice of Meetings

Notice of every meeting of bondholders, setting forth the time and place of such meeting and the purpose of such meeting in reasonable detail, shall be sent by the trustee to the issuer and to each registered bondholder not less than 14 days prior to the date fixed for the meeting. Each of such notices shall be published in a newspaper of general circulation.

2. Failure of the Trustee to Call a Meeting

The failure of the trustee to call a meeting upon the written request of either the issuer or a majority of bondholders within 3 days from such request shall entitle the requesting party to send the appropriate notice of bondholders' meeting; the costs therefor shall be charged to the account of the trustee.

3. Quorum for Meetings

The trustee shall determine and record the presence of the majority (more than 50%) bondholders, personally or by proxy. The presence of the majority bondholders shall be necessary to constitute a quorum to do business at any meeting of the bondholders.

Role of the Trustee in Meetings of the Bondholders:

Notwithstanding any other provisions of the Trust Indenture or Trust Agreement, the Trustee may make such reasonable regulations as it may deem advisable for any meeting of the Bondholders, in regard to proof of ownership of the Bonds, the appointment of proxies by registered holders of the Bonds, the election of the chairman and the secretary, the appointment and duties of inspectors of votes, the submission and examination of proxies, certificates and other evidence of the right to vote and such other matters concerning the conduct of the meeting as it shall deem fit.

Note: The above extract is derived from a generic prospectus of corporate bonds.

N. Event of Default

The following descriptions are taken from a prospectus of corporate bonds in the Philippines for reference.

¹⁴ Asian Development Bank. 2006. *The Asia-Pacific Restructuring and Insolvency Guide 2006*. Malaysia: Shearn Delamore & Co. and PricewaterhouseCoopers. <http://www.adb.org/Documents/Guidelines/restructuring-insolvency/chap4-15.pdf>

Box 1.3 Extract from a Prospectus of Corporate Bonds on an Event of Default

The Issuer shall be considered in default under the Bonds and the Trust Indenture or Trust agreement in case any of the defined events (exhibit the examples of the items, each an “Event of Default”) shall occur and is continuing:

- (a) Non-payment default
- (b) Insolvency default
- (c) Cross default
- (d) Winding up proceedings
- (e) Representation/warranty default
- (f) Covenant default
- (g) Breach of obligations default
- (h) Expropriation default
- (i) Judgment default
- (j) Writ and similar process default
- (k) Closure default
- (l) Validity default
- (m) Change of control default

Consequences of Default:

If anyone or more of the Events of Default shall occur and be continuing after the lapse of the period given to the Issuer within which to cure such Event of Default under the Trust Indenture or Trust Agreement, if any, or upon the occurrence of such Event of Default for which no cure period is provided,

- (i) the Trustee, upon the written direction of the Majority Bondholders, by notice in writing delivered to the Issuer, or
- (ii) the Majority Bondholders, by notice in writing delivered to the Issuer and the Trustee, or
- (iii) the Trustee, in its discretion, in case of a Non-Payment or Insolvency Default, may declare the Issuer in default and declare the principal of the Bonds then outstanding, together with all interest accrued and unpaid thereon and all amounts due thereunder, to be due and payable not later than (for instance) 5 Business Days (the periods provided in the Trust Agreement and in these Terms and Conditions) from the receipt of the declaration of default (“Default Payment Date”) with copy to the Paying Agent, who shall then prepare a payment report in accordance with the Registry and Paying Agency Agreement.

Thereupon, the Issuer shall pay in accordance with the Registry and Paying Agency Agreement.

Note: The above extract is derived from a generic prospectus of corporate bonds.

O. Marketplace or Facilities Involved in Bond Issuance and Trading**1. Exchange**

An exchange is an organized marketplace or facility that brings together buyers and sellers, and executes trades of securities and/or commodities.¹⁵

No buying and selling of a security may be made in an exchange unless it is registered in accordance with Section 33 (Registration of Exchanges) of the SRC and the rules and regulations prescribed by the SEC.¹⁶

To be registered, an exchange must comply with the following requirements:¹⁷

¹⁵ SEC. 2000. “Section 3.7: Definition of Terms - Exchanges,” *Securities Regulation Code* (RA 8799).

¹⁶ According to Section 32.1 of the SRC, “[n]o broker, dealer, salesman, associated person of a broker or dealer, or Exchange, directly or indirectly, shall make use of any facility of an Exchange in the Philippines to effect any transaction in a security, or to report such transaction, unless such Exchange is registered as such under Section 33 of this Code.”

¹⁷ Footnote 15. Section 33.2.

- (i) Must be organized as a stock corporation.
- (ii) Must be engaged solely in the business of operating an exchange.
- (iii) No person may beneficially own or control more than 5% of the voting rights of the exchange for persons, or more than 20% of said voting rights for an industry or business group. However, the SEC may exempt an applicant from compliance of the third requirement where it finds that such ownership or control will not negatively impact the exchange's ability to effectively operate in the public interest.
- (iv) Must be capable of exercising authority over its members and persons associated with its members on conduct or proceedings inconsistent with just and equitable principles of fair trade, and for violations of the SRC, SRC implementing rules, and rules of the exchange.
- (v) Must have a fair procedure for disciplining members and persons associated with its members.
- (vi) Brokers sitting on the board of the exchange shall not exceed 49% of membership in the said board and shall proportionately represent the exchange membership in terms of volume or value of trade and paid-up capital.
- (vii) The president and other management of the exchange should consist only of persons who are not members and are not associated in any capacity, directly or indirectly, with any broker, dealer, member, or listed company of the exchange. However, the exchange may only appoint, and a person may only serve, as an officer of the exchange if such person has not been a member, or have not been affiliated with any broker, dealer, or member of the exchange for a period of at least 2 years prior to such appointment.
- (viii) Must be transparent in the transactions made in the exchange.
- (ix) Must have equitable allocation of fees among members, issuers, and other persons using any facility or system that the exchange operates or controls.
- (x) Must be able to prevent fraudulent and manipulative acts and practices; promote just and equitable principles of trade; and protect investors' and the public's interest.
- (xi) Must have transparent, prompt and accurate clearance and settlement.

2. Over-the-Counter Market

An OTC market refers to the market created by buying and selling securities on a bilateral basis between parties that takes place outside an exchange or in an alternative trading system. The operation and use of an OTC market by registered persons who trade or deal in securities in the secondary market are governed by OTC rules¹⁸ issued by the SEC. As with an exchange, an OTC market needs to be registered with the SEC. A group or organization operating an OTC market should be registered as an SRO in accordance with Section 39 of the SRC.¹⁹

¹⁸ Footnote 11.

¹⁹ According to Section 5 of the SEC Memorandum Circular No. 14, "[n]o group of two or more brokers, dealers and/or salesmen of broker or dealer shall act in concert in making, creating or operating an OTC market unless such group forms and causes the registration of an association of brokers and/or dealers pursuant to Section 39 of the SRC and which association shall act as a self-regulatory organization (SRO) to regulate and supervise the activities of the members of the group or unless the brokers, dealers and/or salesmen who are part of such group are currently members of an SRO in accordance with Section 6 of these rules."

Participants in an OTC market must likewise be members of the SRO operating the OTC market.²⁰

3. Self-Regulatory Organizations

An SRO is an organized exchange, registered clearing agency, or any organization or association registered as an SRO under Section 39 of the SRC to enforce compliance with relevant provisions of the code and its rules and regulations. It is mandated to make and enforce its own rules, which have been approved by the SEC, their members, and/or participants. It is an organization that enforces fair, ethical and efficient practices in the securities and commodity futures industries, including securities and commodity exchanges.

4. Clearing Agency

A clearing agency is any entity that provides a facility to a broker or dealer, salesman, associated person of a broker or dealer, or another clearing agency that performs any or all of the following activities:

- (i) Makes deliveries in connection with transactions in securities;
- (ii) Reduces the number of settlements of securities transactions, or allocates securities settlement responsibilities; and
- (iii) Provides for the central handling of securities so that transfers, loan pledges, and similar transactions can be made by bookkeeping entry, or otherwise, to facilitate the settlement of securities transactions without physical delivery of securities certificates.

5. Transfer Agents

A transfer agent is any person who performs any of the following activities on behalf of an issuer, or on its own as an issuer:

- (i) Countersigns, when applicable, certificates of securities upon their issuance;
- (ii) Monitors the issuance of securities to prevent unauthorized issuances;
- (iii) Registers the transfer of such securities;
- (iv) Exchanges or converts such securities; and/or
- (v) Records the ownership of securities by bookkeeping entry without physical issuance of securities certificates.

Transfer agents may be fiscal agents; normally, transfer agents and trustees are fiduciary agents, and trustees by their designation would not handle payments.

²⁰ According to Section 6A of the SEC Memorandum Circular No. 14, “[n]o broker or dealer shall participate in an OTC market unless he is a member of an SRO that has been registered with the Commission for the purpose of regulating and supervising the activities of the broker or dealer in an OTC market. B. In case a broker or dealer is already a member of an existing SRO whose current status is for the purpose of regulating and supervising a market other than the OTC market, such broker or dealer may be allowed to participate in the OTC market; Provided, that the broker or dealer shows proof and the existing SRO is able to demonstrate that said SRO is capable of performing its regulatory and supervisory obligations relative to the activities of the broker or dealer in the OTC market; Provided further, that the SRO has committed to regulate and supervise the broker or dealer with respect to such activities; Provided finally, that the SRO files an amendment to its current SRO registration to reflect its intention to act as SRO in such OTC market. C. The Commission may prescribe the governance and ownership structure of an SRO or require amendment thereto to ensure the effective regulation and supervision of the OTC market.”

6. Trustees

Public trustees for fixed-income securities are typically entities with trust licenses from the BSP, mostly trust units or departments of banks.

7. Lending Agents for Securities Borrowing and Lending

The SEC Rules on Securities Borrowing and Lending laid-down the rules that govern securities borrowing and lending activities.²¹

Securities borrowing and lending (SBL) is a form of securities business activity regulated by the SEC. Section 39 of the SRC mandates that SEC registers and grants licenses, and supervises and regulates organizations engaged in activities related to or connected with the securities business. Sections 33.2 (I) and 42.2 (e) of the SRC require the transparent, prompt and accurate clearance and settlement of all securities transactions. The framework for an SBL facility must be institutionalized principally because it facilitates the settlement of securities transactions, broadens trading strategies for market participants, and enhances liquidity in the market.

The SRC likewise mandates SEC to regulate the extension and maintenance of credit on securities. The SRC also authorizes the SEC to issue rules and regulations to make effective the provisions of the SRC.

P. Main Participants in the Market

1. Types of Issuers

- (i) National government
- (ii) Government agencies
- (iii) Government-Owned and -Controlled Corporations (GOCCs)
- (iv) Non-bank corporations
- (v) Banks
- (vi) Multilateral agencies

2. Types of Investors

Investors may be classified into professional or qualified investor market and non-qualified, retail or public market.

a. Qualified Investor (Qualified Buyer)

“Qualified Investor” shall theoretically refer to an investor that is not an SEC-registered securities dealer or broker, and is any one of the Qualified Investors as defined under the relevant SEC rules and regulations. However, under current market practice, Qualified Investor activity may still be conducted in entities with a dealer or broker license.

Under the *Rules Governing the Over-the-Counter (OTC) Market (OTC Rules)*,²² “qualified investor” refers to any of the qualified buyers defined under Section 10.1 (L) of the

²¹ SEC. 2006. “Rules on Securities Borrowing and Lending,” *SEC Memorandum Circular No.7, Series of 2006*. <http://www.sec.gov.ph/circulars/cy,2006/sec-memo-7,s2006.pdf>

²² SEC Memorandum Circular No. 14, Series of 2006, “Rules Governing the Over-the-Counter (OTC) Market” is available from the following website: <http://www.sec.gov.ph/circulars/cy,2006/sec-memo-14,s2006.pdf>

SRC,²³ any of the institutional accounts defined under SRC Rule 52.1 (6D),²⁴ or such other person declared by the SEC by rule or order as a qualified investor.

In doing so, the SEC takes into account if the person's net worth or financial background allows him or her to bear the risk that may arise from participating in an OTC market.

Section 10.1 (L) of the SRC lists the following qualified buyers:

- (i) Banks
- (ii) Registered investment houses;
- (iii) Insurance companies;
- (iv) Pension funds or retirement plans maintained by the Government of the Philippines or any of its political subdivisions, or those managed by a bank or other persons authorized by the BSP to engage in trust functions;
- (v) Investment companies; or
- (vi) Other persons the SEC may determine by rule as qualified buyers on the basis of financial sophistication, net worth, knowledge and experience in financial and business matters, or amount of assets under management.

Pursuant to its authority prescribed under the SRC, the SEC issued SEC Memorandum Circular No.6, Series of 2007, "*Definition of Qualified Buyers (Qualified Buyer Rules)*"²⁵ under Section 10 of the SRC" to prescribe regulations on determining individual or juridical persons that may be registered as qualified buyers.

A qualified individual buyer shall be a natural person who:

- (a) Has a minimum annual gross income of PHP25 million at least 2 years prior to registration, or a total portfolio in securities of at least PHP10 million registered with the SEC, or a personal net worth of at least PHP30 million; and
- (b) Has been engaged in securities trading in his personal capacity, or through a fund manager, for a period of 1 year, or held for at least 2 years a position of responsibility in any professional or business entity that requires knowledge or expertise in securities trading.

A qualified institutional buyer shall have a minimum annual gross income of PHP100 million at least 2 years prior to registration, or a total portfolio in securities of at least PHP60 million registered with the SEC, or a personal net worth of at least PHP100 million.

b. Non-Qualified Investors

Investors who do not qualify under the definition of a qualified investor are considered public or retail investors.

²³ Footnote 9. Section 10 (Exempt Transactions). <http://www.sec.gov.ph/index.htm?src/index>

²⁴ SEC. 2004. *Amended Implementing Rules and Regulations (IRR) of The Securities Regulation Code (SRC Rule)*. <http://www.sec.gov.ph/irr/AmendedIRRfinalversion.pdf>

²⁵ SEC. 2007. "Definition of Qualified Buyers under Section 10 of the Securities Regulation Code (SRC)," *SEC Memorandum Circular No.6, Series of 2007*. <http://www.sec.gov.ph/circulars/cy,2007/sec-memo-06,s2007.pdf>

3. Underwriters

An underwriter is a person who guarantees on a firm commitment and/or declared best-effort basis the distribution and sale of securities of any kind by another company.

Under *Presidential Decree (PD) No. 129*, or the *Investment Houses Law*, underwriting of securities is the act or process of guaranteeing by a duly licensed investment house or a universal bank registered as an underwriter of securities with the SEC. It also involves the distribution and sale of securities issued by another person or enterprise, including securities of the government and its instrumentalities.

Underwriters of securities must be registered with and are under the supervision of the SEC. They may either be universal banks or investment houses.

a. Universal Banks

Under the *General Banking Law of 2000* (RA 8791), a universal bank has the authority to exercise the power to invest in non-allied enterprises and the powers of an investment house as provided in existing laws and the power to invest in non-allied enterprises as provided in the same law. These are in addition to the powers authorized to commercial banks. Regulation for universal banks is under the BSP for its banking operations and the SEC for its securities business.

As of 27 June 2011, there are 19 universal banks licensed by the BSP.

b. Investment Houses

Under the *Investment Houses Law*, an investment house is an enterprise that primarily engages in the underwriting of securities of another person or enterprise, including securities of the government or its instrumentalities, whether on a regular or an isolated basis. Investment houses are under the supervision of the SEC.

4. Securities Registries or Transfer Agents (Fiscal Agents)

Under a BSP Circular Letter dated 4 August 2005, a securities registry, other than the BTr, is a BSP-accredited bank or non-bank financial institution designated or appointed by the issuer to maintain the securities registry book, either in electronic or printed form. It records the initial issuance of the securities and subsequent transfer of ownership, and issues registry confirmation to buyers and/or holders. Except otherwise provided in existing BSP regulations, a BSP-accredited securities registry is considered a third party if it has no subsidiary or affiliate relationship with the issuer of securities.

The BTr, as operator of the RoSS, which serves as the official registry for government securities, is not subject to BSP accreditation and is exempted from the independence requirement under the circular.

Under SRC Rule 36.4, no person shall act as a transfer agent for a security listed or traded on an exchange, OTC, or any other trading market without being registered with the SEC in accordance with the provisions of the said rule.

A fiscal agent is typically responsible for the disbursement of issuer payments, including tax related matters; transfer agents may be fiscal agents.

Q. Securities Market Professionals

1. Brokers

A broker is a person engaged in the business of buying and selling securities on behalf of others.²⁶

2. Dealers

A dealer is any person who buys and sells securities for his/her own account in the ordinary course of business.²⁷

3. Salesmen

A salesman refers to a natural person hired to buy and sell securities on a salary or commission basis properly endorsed to the SEC by the employing broker or dealer. He or she also includes any employee of an issuer company whose compensation is determined directly or indirectly by the sales of the issuer's securities.²⁸

4. Associated Person

An associated person is any person employed full time by a broker or dealer whose responsibilities include internal control, supervision of other employees, agents, salesmen, officers, directors, clerks, and stockholders of the broker or dealer for compliance with the SRC and its IRR.²⁹

Brokers, dealers, salesmen, and associated persons of a broker or dealer must be registered with the SEC. Moreover, brokers and dealers must be registered as members of the trading market where they trade and deal in securities, as well as with the SRO exercising regulatory authority over such trading market. Concerning salesmen and associated persons, they must include in their application for registration a proof of affiliation with a broker or dealer. Upon cessation of their affiliation with said broker or dealer, their registration is automatically terminated.

5. Dealers in Government Securities

GSED refers to a SEC-licensed dealer in government securities accredited by the BTr to participate in the primary or origination sale of government securities.

6. Authorized Registrars of Qualified Buyers³⁰

Under SEC Memorandum Circular No.6,³¹ series of 2007, "Definition of Qualified Buyers under Section 10 of the *Securities Regulation Code* (SRC)," SEC laid down the rules on the determination of qualified buyers. The said circular provides for, among others, the registration of qualified buyers by SRO or such other entities that the SEC may authorize to make the registration. The rules and procedures on the registration of qualified buyers by SRO and other entities shall be as follows:

²⁶ Footnote 9. Section 3.3.

²⁷ Footnote 9. Section 3.4.

²⁸ Footnote 24.

²⁹ Footnote 24.

³⁰ SEC. 2008. "Rules Governing Registrars of Qualified Buyers," *SEC Memorandum Circular No.3, Series of 2008*. <http://www.sec.gov.ph/circulars/cy,2008/sec-memo-03,s2008.pdf>

³¹ Footnote 25.

Authorized Registrars - The following entities, which have been granted the appropriate secondary license by the SEC, are eligible to act as registrar of qualified buyers, subject to prior authorization from the SEC:

- (i) Banks with respect to their registration as broker-dealer, GSED, and/or underwriter of securities;
- (ii) Brokers;
- (iii) Dealers;
- (iv) Investment houses;
- (v) Investment company advisers; and
- (vi) Issuer companies with respect to offerings of their own securities.

II. Primary and Secondary Market Regulatory Frameworks

A. Philippine Market Regulatory Structure

Local and foreign investors may invest in the Philippine bond market. To protect investors, the *Insolvency Law* and Civil Code provide details on bondholder rights. Guidelines on cross-border portfolio investment are issued by the Bangko Sentral ng Pilipinas (BSP).

1. Bangko Sentral ng Pilipinas

The BSP supervises banks and non-bank financial institutions that perform quasi-banking functions. It also supervises the registration of foreign investments in the country and monitors the inflow and outflow of capital.

2. Securities and Exchange Commission

The Securities and Exchange Commission (SEC) regulates both primary and secondary debt markets, and oversees the Philippine Stock Exchange, the three subsidiaries of the Philippine Dealing Systems Holdings Corporation (PDS Group), brokers, registrars, transfer agents, and clearinghouses.

3. Department of Finance and Bureau of the Treasury

The Department of Finance (DOF) regulates the issuance of government securities in the market while the DOF's Bureau of the Treasury operates and monitors daily debt-market activity.

4. Philippine Dealing System (PDS) Group of Companies

The PDS Group manages the country's first electronic platform for trading, clearing, settlement, depository, registry, and custody of fixed-income securities and derivatives. The PDS Group has three operating subsidiaries:

- (i) Philippine Dealing and Exchange Corporation (PDEX)—an entity that operates the electronic trading platforms for securities, providing price discovery and transparency services, self-regulatory functions, and is linked to the settlement systems. As market operator in the fixed income market, it likewise manages the market's liquidity programs—the Securities Lending Transactions Program and the Inter-Professional Repurchase Agreement Market Program.

- (ii) Philippine Depository and Trust Corporation (PDTC)—an entity that provides central securities depository services for both the equities and fixed income markets, and registry services for the fixed income market. It is likewise engaged in the PDEX liquidity programs as Collateral Manager.
- (iii) Philippine Securities Settlement Corporation (PSSC)—the company that provides electronic settlement facilities with straight-through process (STP) and delivery-versus-payment (DVP) capabilities.³²

B. Regulation of the Philippine Securities Markets

1. Broad Legislative Framework

As stated above, the SEC is the primary regulatory body of the primary and secondary debt markets, as well as the different participants in the Philippine bond market.

Under Section 5 (Powers and Functions of the Commission) of the Securities Regulation Code (SRC), the SEC shall have, among others, the following powers and functions:

- (i) Jurisdiction and supervision over all corporations, partnerships, or associations that are grantees of primary franchises and/or a license or permit issued by the government;
- (ii) Formulate policies and recommendations on issues concerning the securities market, advise Congress and other government agencies on all aspects of the securities market, and propose corresponding legislation and amendments;
- (iii) Approve, reject, suspend, revoke, or require amendments to registration statements and registration and licensing applications;
- (iv) Regulate, investigate, or supervise the activities of persons to ensure compliance;
- (v) Supervise, monitor, suspend, or take over the activities of exchanges, clearing agencies and other self-regulatory organizations (SROs);
- (vi) Impose sanctions for the violation of laws, rules and regulations, and orders concerning the securities market;
- (vii) Prepare, approve, amend, or repeal rules, regulations and orders, as well as issue opinions and provide guidance on and supervise compliance with such rules, regulations and orders;
- (viii) Enlist the aid and support of and/or deputize any and all enforcement agencies of the government—civil or military—as well as any private institution, corporation, firm, association, or person in the implementation of its powers and functions under the SRC;
- (ix) Issue cease-and-desist orders to prevent fraud or injury to the investing public;
- (x) Punish for contempt of the SEC, both direct and indirect, in accordance with the pertinent provisions of and penalties prescribed by the rules of court;
- (xi) Compel officers of any registered corporation or association to call meetings of stockholders or members under its supervision;
- (xii) Issue *subpoena duces tecum*³³ and summon witnesses to appear in any proceedings of the SEC and in appropriate cases; and order the examination, search and seizure of all documents, papers, files and records, tax returns, and books of accounts of any entity or person under investigation as may be necessary for the proper

³² More details may be found in the PDEX website, <http://www.pdex.com.ph>.

³³ Literally “under penalty you shall bring with you.”

- disposition of the cases before it, subject to the provisions of existing laws;
- (xiii) Suspend or revoke after proper notice and hearing the franchises or certificates of registration of corporations, partnerships or associations, upon any of the grounds provided by law; and
- (xiv) Exercise such other powers as may be provided by law, as well as those which may be implied from, or which are necessary or incidental to the carrying out of, the express powers granted the SEC to achieve the objectives and purposes of laws on the securities market.

2. Trading Participants

According to the Amended PDEX *Rules for the Fixed Income Securities Market*,³⁴ a trading participant shall be any person that has been qualified to trade on the PDEX trading system. There are three types of trading participants:

- (1) Dealing participants who may be market-making participants as defined in the PDEX Rules;
- (2) Qualified investor participants who may opt not to be members of the SRO, hence not bound by the relevant SEC rules and regulations but by the pertinent agreements; and
- (3) Brokering participants.

C. Rules and Regulations on Issuing Debt Instruments

1. Disclosure Requirements and Exemptions

Debt securities may not be offered for sale to the public, unless these securities are registered in accordance with Section 8 (Rule 8.1) and 12 (Rule 12.1) of the SRC³⁵.

However, securities that are exempt from registration under Section 9 (Exempt Securities) and Section 10 (Exempt Transactions) under Rules 9.2 and 10.1, respectively, may be offered for sale to the public.

Table 2.1 Extract on Exemption from Disclosure Requirements-Related Descriptions from the Securities Regulation Code

SEC. 8. Requirement of Registration of Securities. Rule 8.1	Securities shall not be sold or offered for sale or distribution within the Philippines, without a registration statement duly filed with and approved by the Commission (SEC). Prior to such sale, information on the securities, in such form and with such substance as the Commission may prescribe, shall be made available to each prospective purchaser.
SEC. 9. Exempt Securities. Rule 9.1	The requirement of registration under Subsection 8.1 shall not as a general rule apply to any of the following classes of securities: a) Any security issued or guaranteed by the Government of the Philippines, or by any political subdivision or agency thereof, or by any person controlled or supervised by, and acting as an instrumentality of said Government. b) Any security issued or guaranteed by the government of any country with which the Philippines maintains diplomatic relations, or by any state, province or political subdivision thereof on the basis of reciprocity: Provided, That the Commission may require compliance with the form and content of disclosures the Commission may prescribe. c) Certificates issued by a receiver or by a trustee in bankruptcy duly approved by the proper adjudicatory body.

continued on next page

³⁴ Footnote 10.

³⁵ Footnote 9.

Table 2.1 continuation

	<p>d) Any security or its derivatives the sale or transfer of which, by law, is under the supervision and regulation of the Office of the Insurance Commission, Housing and Land Use Regulatory Board, or the Bureau of Internal Revenue.</p> <p>e) Any security issued by a bank except its own shares of stock.</p>						
SEC. 9. Exempt Securities. Rule 9.2	The Commission may, by rule or regulation after public hearing, add to the foregoing any class of securities if it finds that the enforcement of this Code with respect to such securities is not necessary in the public interest and for the protection of investors.						
SEC.10. Exempt Transactions. Rule 10.1	<p>The requirement of registration under Subsection 8.1 shall not apply to the sale of any security in any of the following transactions:</p> <p>a) At any judicial sale, or sale by an executor, administrator, guardian or receiver or trustee in insolvency or bankruptcy.</p> <p>b) By or for the account of a pledge holder, or mortgagee or any other similar lien holder selling or offering for sale or delivery in the ordinary course of business and not for the purpose of avoiding the provisions of this Code, to liquidate a bona fide debt, a security pledged in good faith as security for such debt.</p> <p>c) An isolated transaction in which any security is sold, offered for sale, subscription or delivery by the owner thereof, or by his representative for the owner's account, such sale or offer for sale, subscription or delivery not being made in the course of repeated and successive transactions of a like character by such owner, or on his account by such representative and such owner or representative not being the underwriter of such security.</p> <p>d) The distribution by a corporation, actively engaged in the business authorized by its articles of incorporation, of securities to its stockholders or other security holders as a stock dividend or other distribution out of surplus.</p> <p>e) The sale of capital stock of a corporation to its own stockholders exclusively, where no commission or other remuneration is paid or given directly or indirectly in connection with the sale of such capital stock.</p> <p>f) The issuance of bonds or notes secured by mortgage upon real estate or tangible personal property, where the entire mortgage together with all the bonds or notes secured thereby are sold to a single purchaser at a single sale.</p> <p>g) The issue and delivery of any security in exchange for any other security of the same issuer pursuant to a right of conversion entitling the holder of the security surrendered in exchange to make such conversion: Provided, That the security so surrendered has been registered under this Code or was, when sold, exempt from the provisions of this Code, and that the security issued and delivered in exchange, if sold at the conversion price, would at the time of such conversion fall within the class of securities entitled to registration under this Code. Upon such conversion the par value of the security surrendered in such exchange shall be deemed the price at which the securities issued and delivered in such exchange are sold.</p> <p>h) Broker's transactions, executed upon customer's orders, on any registered Exchange or other trading market.</p> <p>i) Subscriptions for shares of the capital stock of a corporation prior to the incorporation thereof or in pursuance of an increase in its authorized capital stock under the Corporation Code, when no expense is incurred, or no commission, compensation or remuneration is paid or given in connection with the sale or disposition of such securities, and only when the purpose for soliciting, giving or taking of such subscriptions is to comply with the requirements of such law as to the percentage of the capital stock of a corporation which should be subscribed before it can be registered and duly incorporated, or its authorized capital increased.</p> <p>j) The exchange of securities by the issuer with its existing security holders exclusively, where no commission or other remuneration is paid or given directly or indirectly for soliciting such exchange.</p> <p>k) The sale of securities by an issuer to fewer than twenty (20) persons in the Philippines during any twelve-month period.^a</p>						
	<table border="1"> <tr> <td>Current version - Amended Implementing Rules and Regulations (IRR) of The Securities Regulation Code (Signed version of the Amended IRR published February 2004)</td> <td>Draft version of the Revised Implementing Rules and Regulations (IRR) of The Securities Regulation Code (Posted February 2011 for public comment. Public comments were closed on March 15, 2011)</td> </tr> <tr> <td>SRC Rule 10.1 – Exempt Transactions</td> <td>Rule 10.1 – Exempt Transactions</td> </tr> <tr> <td> <p>1. Disclosure to Investors</p> <p>Any person claiming exemption under Section 10.1 of the Code shall provide to any person to whom it offers for sale or sells securities in reliance on such exemption a written disclosure containing the following information:</p> <p>i. The provision of Section 10.1 of the Code under which exemption from registration is claimed;</p> <p>ii. Whether the Commission's confirmation that such offer or sale qualifies as an exempt transaction has been obtained; and</p> <p>iii. The following statement in bold face, prominent type: THE SECURITIES BEING OFFERED OR SOLD HEREIN HAVE NOT BEEN REGISTERED WITH THE SECURITIES</p> </td> <td> <p>1. Disclosure to Investors</p> <p>Any person claiming exemption under Section 10.1 of the Code shall provide to any party to whom it offers to sell or sells securities in reliance on such exemption a written disclosure containing the following information:</p> <p>A. The specific provision of Section 10.1 of the Code on which the exemption from registration is claimed; and</p> <p>B. The following statement in bold face: THE SECURITIES BEING OFFERED FOR SALE OR SOLD HEREIN HAVE NOT BEEN REGISTERED WITH THE SECURITIES AND EXCHANGE COMMISSION UNDER THE SECURITIES REGULATION CODE. ANY FUTURE OFFER TO SELL OR SALE OF THE SECURITIES IS SUBJECT TO</p> </td> </tr> </table>	Current version - Amended Implementing Rules and Regulations (IRR) of The Securities Regulation Code (Signed version of the Amended IRR published February 2004)	Draft version of the Revised Implementing Rules and Regulations (IRR) of The Securities Regulation Code (Posted February 2011 for public comment. Public comments were closed on March 15, 2011)	SRC Rule 10.1 – Exempt Transactions	Rule 10.1 – Exempt Transactions	<p>1. Disclosure to Investors</p> <p>Any person claiming exemption under Section 10.1 of the Code shall provide to any person to whom it offers for sale or sells securities in reliance on such exemption a written disclosure containing the following information:</p> <p>i. The provision of Section 10.1 of the Code under which exemption from registration is claimed;</p> <p>ii. Whether the Commission's confirmation that such offer or sale qualifies as an exempt transaction has been obtained; and</p> <p>iii. The following statement in bold face, prominent type: THE SECURITIES BEING OFFERED OR SOLD HEREIN HAVE NOT BEEN REGISTERED WITH THE SECURITIES</p>	<p>1. Disclosure to Investors</p> <p>Any person claiming exemption under Section 10.1 of the Code shall provide to any party to whom it offers to sell or sells securities in reliance on such exemption a written disclosure containing the following information:</p> <p>A. The specific provision of Section 10.1 of the Code on which the exemption from registration is claimed; and</p> <p>B. The following statement in bold face: THE SECURITIES BEING OFFERED FOR SALE OR SOLD HEREIN HAVE NOT BEEN REGISTERED WITH THE SECURITIES AND EXCHANGE COMMISSION UNDER THE SECURITIES REGULATION CODE. ANY FUTURE OFFER TO SELL OR SALE OF THE SECURITIES IS SUBJECT TO</p>
Current version - Amended Implementing Rules and Regulations (IRR) of The Securities Regulation Code (Signed version of the Amended IRR published February 2004)	Draft version of the Revised Implementing Rules and Regulations (IRR) of The Securities Regulation Code (Posted February 2011 for public comment. Public comments were closed on March 15, 2011)						
SRC Rule 10.1 – Exempt Transactions	Rule 10.1 – Exempt Transactions						
<p>1. Disclosure to Investors</p> <p>Any person claiming exemption under Section 10.1 of the Code shall provide to any person to whom it offers for sale or sells securities in reliance on such exemption a written disclosure containing the following information:</p> <p>i. The provision of Section 10.1 of the Code under which exemption from registration is claimed;</p> <p>ii. Whether the Commission's confirmation that such offer or sale qualifies as an exempt transaction has been obtained; and</p> <p>iii. The following statement in bold face, prominent type: THE SECURITIES BEING OFFERED OR SOLD HEREIN HAVE NOT BEEN REGISTERED WITH THE SECURITIES</p>	<p>1. Disclosure to Investors</p> <p>Any person claiming exemption under Section 10.1 of the Code shall provide to any party to whom it offers to sell or sells securities in reliance on such exemption a written disclosure containing the following information:</p> <p>A. The specific provision of Section 10.1 of the Code on which the exemption from registration is claimed; and</p> <p>B. The following statement in bold face: THE SECURITIES BEING OFFERED FOR SALE OR SOLD HEREIN HAVE NOT BEEN REGISTERED WITH THE SECURITIES AND EXCHANGE COMMISSION UNDER THE SECURITIES REGULATION CODE. ANY FUTURE OFFER TO SELL OR SALE OF THE SECURITIES IS SUBJECT TO</p>						

continued on next page

Table 2.1 continuation

	<p>AND EXCHANGE COMMISSION UNDER THE SECURITIES REGULATION CODE. ANY FUTURE OFFER OR SALE THEREOF IS SUBJECT TO REGISTRATION REQUIREMENTS UNDER THE CODE UNLESS SUCH OFFER OR SALE QUALIFIES AS AN EXEMPT TRANSACTION.</p> <p>2. Exempt Transactions Not Requiring Notice No notice of exemption or fee shall be required for any transaction covered by Section 10.1 of the Code except those covered by subparagraphs (k) and (l) or sale to not more than nineteen (19) persons and to qualified buyers, respectively.</p> <p>3. Exempt Transactions Requiring Notice A. Notice of exemption on SEC Form 10-1 shall be required in an offering or distribution of securities under Section 10.1(k) and (l) of the Code. B. The issuer shall file with the Commission a notice of exemption from the registration requirements under Section 8 of the Code on SEC Form 10-1, including, as an exhibit thereto, all pertinent information required to be furnished to the investors pursuant to this paragraph, within ten (10) days after the sale of the securities which are subject thereto. No filing fee shall be required for the said notice. C. Private Placements under Section 10.1(k) of the Code i. A prima facie presumption of circumvention of Sections 8 and 12 of the Code shall arise when the number of non-qualified investors shall exceed nineteen (19) within one (1) year. The issuer shall be liable for penalty in accordance with the Scale of Fines of the Commission, without prejudice to other actions which may be taken against the issuer. ii. If the initial purchaser/s shall resell said securities to more than nineteen (19) non-qualified investors, Sections 8 and 12 of the SRC shall apply, notwithstanding the exemption of their issuances, unless such succeeding sale shall qualify as an exempt transaction. iii. Exemptive relief under Section 10.1(k) (Private Placement) shall be subject to the following terms and conditions: a. The issuer claiming such relief shall not engage in any form of general solicitation or advertising in connection therewith; b. Securities sold in any such transaction may only be sold to persons purchasing for their own account; c. Sale may be made to no more than nineteen (19) "non-qualified" buyers. A corporation, partnership or other entity shall be counted as one buyer; provided, however, that if the entity is organized for the specific purpose of acquiring the securities offered and is not a qualified buyer under Section 10.1(l) of the Code, then each beneficial owner of equity securities in the entity shall count as a separate buyer under this Rule; d. The issuer provides any person to whom they offer for sale or sell securities pursuant thereto with the following information:</p>	<p>THE REGISTRATION REQUIREMENTS UNDER THE CODE UNLESS SUCH OFFER TO SELL OR SALE QUALIFIES AS AN EXEMPT TRANSACTION.</p> <p>2. Restrictions for Transactions under Section 10.1(k) of the Code A) Sections 8 and 12 of the Code are violated if the number of non-qualified investors exceeds nineteen (19) within a twelve (12) month period, or when a security instrument or any document evidencing a securities transaction is issued to a nonqualified buyer by a foreign financial institution or intermediary that has a presence in the Philippines regardless of the site of the issuance or execution of the said instrument or document. The local branch, representative office or any similar office of the said foreign financial institution shall have the burden of proof, if questioned, in proving that it had no participation, direct or indirect, in the said transaction. The issuer of the security or, in the proper case, the foreign financial institution and its representative in the Philippines regardless of the nature or manner of its representation, shall be liable for penalty in accordance with the rules of the Commission, without prejudice to other actions that may be taken against it. B) If the initial purchaser/s resell the said securities to more than nineteen (19) non-qualified investors, Sections 8 and 12 of the Code shall apply, notwithstanding the exemption of the initial transaction unless such succeeding sale qualifies as an exempt transaction. C) Debt instruments issued by other Issuers, such as, financing and lending companies without quasi-banking licenses, shall not be considered exempt transactions if they exceed Fifty Million Pesos (PhP50,000,000) or such higher amount as the Commission may prescribe. D) A request for confirmation of exemption under Section 10.1(k) shall be subject to the following terms and conditions: (i) The Issuer claiming relief shall not engage in any form of general solicitation or advertising in that connection; (ii) Securities sold in any such transaction may only be sold to persons purchasing for their own account; (iii) The sale may be made to not more than nineteen (19) "non-qualified" buyers. A corporation, partnership or other entity shall be counted as one buyer; provided, that if the entity is organized for the specific purpose of acquiring the securities offered and is not a qualified buyer under Section 10.1(l) of the Code, then each beneficial owner of equity securities in the entity shall be counted as a separate buyer under this Rule; (iv) The Issuer provides any person to whom it offers for sale or sells securities the following information in writing: [1] name of the Issuer and its predecessor, if any; [2] address of its principal executive office; [3] place of incorporation; [4] title and class of the security; [5] par or issue value of the security; [6] number of shares or total amount of securities</p>
--	------------------------------------------------------------------------------------------------------------------------------------------------------------------------------------------------------------------------------------------------------------------------------------------------------------------------------------------------------------------------------------------------------------------------------------------------------------------------------------------------------------------------------------------------------------------------------------------------------------------------------------------------------------------------------------------------------------------------------------------------------------------------------------------------------------------------------------------------------------------------------------------------------------------------------------------------------------------------------------------------------------------------------------------------------------------------------------------------------------------------------------------------------------------------------------------------------------------------------------------------------------------------------------------------------------------------------------------------------------------------------------------------------------------------------------------------------------------------------------------------------------------------------------------------------------------------------------------------------------------------------------------------------------------------------------------------------------------------------------------------------------------------------------------------------------------------------------------------------------------------------------------------------------------------------------------------------------------------------------------------------------------------------------------------------------------------------------------------------------------------------------------------------------------------------------------------------------------------------------------------------------------------------------------------------------------------------------------------------------------------------------------------------------------------------------------------------------------------------------------------------------------------------------------------------------------------------------------------------------------------------------------------------------------------------------------------------------------------------------------------------------------------------------------------------------------------------------------------------------------------------------	--------------------------------------------------------------------------------------------------------------------------------------------------------------------------------------------------------------------------------------------------------------------------------------------------------------------------------------------------------------------------------------------------------------------------------------------------------------------------------------------------------------------------------------------------------------------------------------------------------------------------------------------------------------------------------------------------------------------------------------------------------------------------------------------------------------------------------------------------------------------------------------------------------------------------------------------------------------------------------------------------------------------------------------------------------------------------------------------------------------------------------------------------------------------------------------------------------------------------------------------------------------------------------------------------------------------------------------------------------------------------------------------------------------------------------------------------------------------------------------------------------------------------------------------------------------------------------------------------------------------------------------------------------------------------------------------------------------------------------------------------------------------------------------------------------------------------------------------------------------------------------------------------------------------------------------------------------------------------------------------------------------------------------------------------------------------------------------------------------------------------------------------------------------------------------------------------------------------------------------------------------------------------------------------------------------------------------------------------------------------------------------------------------------------------------------------------------------------------------------------------------------------------------------------------------------------------------------------------------------------------------------------------------------------------------------------------------------------------------------------------------------------------------------------------------------------------------------------------------------------------------------------------------------------------------------------------------------------------------------------------------------------------------------------------------------------------------------------

continued on next page

Table 2.1 continuation

	<p>1) exact name of the issuer and its predecessor, if any; 2) address of its principal executive office; 3) place of incorporation; 4) exact title and class of the security; 5) par or issue value of the security; 6) number of shares or total amount of securities outstanding as of the end of the issuer's most recent fiscal year; 7) name and address of the transfer agent; 8) nature of the issuer's business; 9) nature of products or services offered; 10) nature and extent of the issuer's facilities; 11) name of the chief executive officers and members of the board of directors; 12) issuer's most recent financial statements for each of the two preceding fiscal years or such shorter period as the issuer (including its predecessor) has been in existence; 13) whether the person offering or selling the securities is affiliated, directly or indirectly, with the issuer; 14) whether the offering is being made directly or indirectly on behalf of the issuer, or any director, officer or person who owns directly or indirectly more than ten percent (10%) of the outstanding shares of any equity security of the issuer and, if so, the name of such person; and 15) information required under paragraph 1 of this Rule. Provided, however, that where the issuer is a reporting company under Section 17 of the Code, a copy of its most recent annual report (SEC Form 17-A) may be used to provide any of the required information.</p> <p>D. Offer or Sale of Securities to Qualified Buyers under Section 10.1(l) of the Code If the initial qualified buyer/s shall resell their securities to more than nineteen (19) nonqualified buyers/investors, Sections 8 and 12 of the Code shall apply.</p> <p>4. Application for Confirmation or Declaration of Exemption</p> <p>A. If a confirmation of exemption shall be obtained from the Commission, a duly accomplished SEC Form 10-1 shall be filed with the corresponding filing fee.</p> <p>B. In cases which involve distribution of securities by way of stock dividend, the Commission shall determine the sufficiency of the retained earnings of the issuer company prior to issuing a confirmation thereto.</p> <p>C. Where the consideration for the offered securities is other than actual cash, a request for confirmation of exemption from registration under Section 10 of the Code shall deem to include an application for approval of valuation required under Section 62 of the Corporation Code of the Philippines, or vice versa.</p> <p>5. Exempt Commercial Paper Transactions</p> <p>An issuer of commercial papers under an exempt transaction shall:</p> <p>A. File a Notice or Application for Confirmation of Exemption (SEC Form 10-1) prior to issuance thereof. Said application shall be accompanied by the prescribed filing fees and include a disclosure of the following financial ratios: Current Ratio = Current Assets/Current Liabilities</p>	<p>outstanding as of the end of the issuer's most recent fiscal year; [7] name and address of the transfer agent; [8] nature of the Issuer's business; [9] nature of products or services offered; [10] nature and extent of the Issuer's facilities; [11] name of the chief executive officer and members of the board of directors; [12] the Issuer's most recent financial statements for the two preceding fiscal years or such shorter period as the issuer (including its predecessor) if it has been in existence; [13] whether the person offering or selling the securities is affiliated, directly or indirectly, with the Issuer; [14] whether the offering is being made directly or indirectly on behalf of the Issuer, or any director, officer or person who owns directly or indirectly more than ten percent (10%) of the outstanding shares of any equity security of the Issuer and, if so, the name of such person; and [15] information required under paragraph 1 of this Rule; provided, however, that if the Issuer is a reporting company under Section 17 of the Code, a copy of its most recent annual report may be used to provide the required information.</p> <p>E. Offer or Sale of Securities to Qualified Buyers under Section 10.1(l) of the Code. If the initial qualified buyer/s resell their securities to more than nineteen (19) non-qualified buyers/investors, Sections 8 and 12 of the Code shall apply.</p> <p>3. Application for Confirmation or Declaration of Exemption</p> <p>A. If the Issuer wants a confirmation of exemption under Section 10.1 of the Code, it shall file SEC Form 10-1 with the Commission.</p> <p>B. In cases involving the distribution of securities through stock dividends, the Commission shall determine the sufficiency of the retained earnings of the Issuer prior to issuing a confirmation of exemption.</p> <p>C. If the consideration for the offered securities is other than cash, except in the case of issuance of shares by way of stock dividends, a request for confirmation of exemption from registration shall be filed with Company Registration and Monitoring Department of the Commission and shall be deemed to include an application for approval of valuation required under Section 62 of the Corporation Code and vice versa.</p> <p>4. Exempt Commercial Paper Transactions</p> <p>An Issuer of commercial papers in an exempt transaction shall:</p> <p>A. File a Notice or Application for Confirmation of Exemption (SEC Form 10-1) prior to issuance. The application shall make a disclosure of the following financial ratios: Current Ratio = Current Assets/Current Liabilities Debt to equity Ratio = Total Liabilities/Stockholders' Equity</p> <p>B. Indicate in bold letters on the face of the instrument the words: NON-NEGOTIABLE/NON-ASSIGNABLE</p> <p>C. The Issuer of outstanding long term commercial papers</p>
--	-------------------------------------------------------------------------------------------------------------------------------------------------------------------------------------------------------------------------------------------------------------------------------------------------------------------------------------------------------------------------------------------------------------------------------------------------------------------------------------------------------------------------------------------------------------------------------------------------------------------------------------------------------------------------------------------------------------------------------------------------------------------------------------------------------------------------------------------------------------------------------------------------------------------------------------------------------------------------------------------------------------------------------------------------------------------------------------------------------------------------------------------------------------------------------------------------------------------------------------------------------------------------------------------------------------------------------------------------------------------------------------------------------------------------------------------------------------------------------------------------------------------------------------------------------------------------------------------------------------------------------------------------------------------------------------------------------------------------------------------------------------------------------------------------------------------------------------------------------------------------------------------------------------------------------------------------------------------------------------------------------------------------------------------------------------------------------------------------------------------------------------------------------------------------------------------------------------------------------------------------------------------------------------------------------------------------------------------------------------------------------------------------------------------------------------------------------------------------------------------------------------------------------------------------------------------------------------------------------------------------------------------------------------------------------------------------------------------------------------------------------------------------------------------------------------------------------------------------------------------------------------------------------------------------------------------------------------------------------------------------------------------------------------------------------------------------------------------------------------------------------------------------------------------------------------------------------------------------------------------------------------------------------------------------------------------------------	-----------------------------------------------------------------------------------------------------------------------------------------------------------------------------------------------------------------------------------------------------------------------------------------------------------------------------------------------------------------------------------------------------------------------------------------------------------------------------------------------------------------------------------------------------------------------------------------------------------------------------------------------------------------------------------------------------------------------------------------------------------------------------------------------------------------------------------------------------------------------------------------------------------------------------------------------------------------------------------------------------------------------------------------------------------------------------------------------------------------------------------------------------------------------------------------------------------------------------------------------------------------------------------------------------------------------------------------------------------------------------------------------------------------------------------------------------------------------------------------------------------------------------------------------------------------------------------------------------------------------------------------------------------------------------------------------------------------------------------------------------------------------------------------------------------------------------------------------------------------------------------------------------------------------------------------------------------------------------------------------------------------------------------------------------------------------------------------------------------------------------------------------------------------------------------------------------------------------------------------------------------------------------------------------------------------------------------------------------------------------------------------------------------------------------------------------------------------------------------------------------------------------------------------------------------------------------------------------------------------------------------------------------------------------------------------------------------------------------------------------------------------------------------------------------------------------------------------------------------------------------------------------------------------------------------------------------------------------------------------------------------------------------------------------------------------------------------------------------------------------------------------------------------------------------------------------------------------------------------------------

continued on next page

Table 2.1 continuation

	<p>Acid Test Ratio = Cash, receivables and marketable securities/Current Liabilities Net Profit Margin= Net income after income tax/Net Sales or revenues Return on Equity= Net income after income tax/Total Stockholders' Equity Interest Service Charge Ratio = Net income before interest expense/Interest Expense Debt to equity ratio = Total Liabilities/Stockholders'Equity</p> <p>B. Indicate in bold letters on the face of the instrument the words: “NON-NEGOTIABLE/NON-ASSIGNABLE”</p> <p>C. That any issuer with outstanding long term commercial papers shall likewise file the prescribed disclosure statement and quarterly reports on such borrowings.</p> <p>6. Other Requirements and Limitations A. Exemptive relief under Section 10.1(c) (Isolated Transaction) of the Code shall not be available to an issuer of securities which shall not be considered as an “owner” thereof. B. In connection with a transaction under Section 10.1(i) of the Code, any fee paid pursuant to the requirements of the Corporation Code may be applied in satisfaction of fees owed in relation to an application for confirmation of exemption. C. The Commission shall not be precluded from taking whatever action it may deem appropriate on any application for confirmation even if filed after the offer or sale of the securities without prejudice to the imposition of penalties when warranted by the situation.</p> <p>7. Burden of Proof that Such Exemption is Available A. Unless confirmation of the availability of such exemption is applied for under paragraph 4 of this Rule, any person claiming an exemption under Section 10 has the burden, if challenged, to establish that the exemption is available. The Commission may challenge such exemption at any time. B. A presumption that an exemption is not available may arise from the failure to file a notice as required by paragraph 3 of this Rule. Failure to file such notice shall also subject a person claiming an exemption under Section 10 to sanctions under the Code.</p> <p>8. The sale or offer for sale of a security in any transaction exempt under Section 10 shall not be exempt from antifraud, civil liability or other provisions of the Code.</p> <p>9. In view of the objective of full and fair disclosure under the Code, exemptive relief under Section 10 of the Code shall not be available to any issuer or other persons for any transaction or chain of transactions that, although in technical compliance with the Code and this Rule, shall be a part of a plan or scheme to evade the registration provisions of the Code. In such cases, registration under the Code shall be required.</p>	<p>shall also file the prescribed disclosure statement and semestral reports on such borrowings.</p> <p>5. Other Requirements and Limitations A. A request for confirmation of exemption under Section 10.1(c) of the Code shall be available only to Issuers. B. The Commission may take any action it may deem appropriate in an application for confirmation even if it is filed after the offer or sale of the securities without prejudice to the imposition of penalties if warranted.</p> <p>6. Burden of Proof on the Availability of Exemption Unless a confirmation of exemption is applied for under paragraph 4 of this Rule, any person claiming exemption under Section 10 of the Code has the burden of proof, if challenged, of showing that it is entitled to the exemption. The Commission may challenge such exemption any time.</p> <p>7. The sale or offer for sale of a security in an exempt transaction under Section 10 of the Code shall not exempt it from anti-fraud, civil liability or other liability provisions of the Code.</p> <p>8. A request for confirmation of exemption under Section 10 of the Code shall not be available to any Issuer or other persons to any transaction or chain of transactions that, although it may appear to be in compliance with the Code and these Rules, is a part of a plan or scheme to evade compliance with the registration requirements of the Code. In such cases, registration shall be mandatory.</p> <p>9. Qualified Buyers A. For purposes of Section 10 of the Code, a natural person shall be considered a qualified individual buyer if he has registered as such with a Self Regulatory Organization and such other entities that may be authorized by the Commission, and possesses the following qualifications: (i) Has an annual gross income of at least Twenty Five Million Pesos at least two (2) years prior to registration, or a total portfolio investment in securities registered with the Commission of at least Ten Million Pesos, or a personal net worth of not less than Thirty Million Pesos; and (ii) Has been engaged in securities trading personally or through a fund manager for a minimum period of one (1) year, or has held for at least two (2) years a position of responsibility in any professional business entity that requires knowledge or expertise in securities trading, such as, legal consultant, financial adviser, sales person, or associated person of a broker-dealer, bank finance or treasury officer, trust officer or other similar executive officers. B. If the buyer is a juridical person, it shall, at the time of registration with an authorized registrar, (i) have an annual gross income of at least One Hundred Fifty Million Pesos at least two (2) years prior to registration; or (ii) a total portfolio investment in securities registered with the Commission of at least Sixty Million Pesos; or (iii) a net worth of not less than One Hundred Million Pesos.</p>
--	-------------------------------------------------------------------------------------------------------------------------------------------------------------------------------------------------------------------------------------------------------------------------------------------------------------------------------------------------------------------------------------------------------------------------------------------------------------------------------------------------------------------------------------------------------------------------------------------------------------------------------------------------------------------------------------------------------------------------------------------------------------------------------------------------------------------------------------------------------------------------------------------------------------------------------------------------------------------------------------------------------------------------------------------------------------------------------------------------------------------------------------------------------------------------------------------------------------------------------------------------------------------------------------------------------------------------------------------------------------------------------------------------------------------------------------------------------------------------------------------------------------------------------------------------------------------------------------------------------------------------------------------------------------------------------------------------------------------------------------------------------------------------------------------------------------------------------------------------------------------------------------------------------------------------------------------------------------------------------------------------------------------------------------------------------------------------------------------------------------------------------------------------------------------------------------------------------------------------------------------------------------------------------------------------------------------------------------------------------------------------------------------------------------------------------------------------------------------------------------------------------------------------------------------------------------------------------------------------------------------------------------------------------------------------------------------------------------------------------------------------------------------------------------------	-------------------------------------------------------------------------------------------------------------------------------------------------------------------------------------------------------------------------------------------------------------------------------------------------------------------------------------------------------------------------------------------------------------------------------------------------------------------------------------------------------------------------------------------------------------------------------------------------------------------------------------------------------------------------------------------------------------------------------------------------------------------------------------------------------------------------------------------------------------------------------------------------------------------------------------------------------------------------------------------------------------------------------------------------------------------------------------------------------------------------------------------------------------------------------------------------------------------------------------------------------------------------------------------------------------------------------------------------------------------------------------------------------------------------------------------------------------------------------------------------------------------------------------------------------------------------------------------------------------------------------------------------------------------------------------------------------------------------------------------------------------------------------------------------------------------------------------------------------------------------------------------------------------------------------------------------------------------------------------------------------------------------------------------------------------------------------------------------------------------------------------------------------------------------------------------------------------------------------------------------------------------------------------------------------------------------------------------------------------------------------------------------------------------------------------------------------------------------------------------------------------------------------------------------------------------------------------------------------------------------------------------------------------------------------------------------------------------------------------------------------------------------------------------------------------------------------------------------------------------------------------------------------------------------------------------------------------------------------------------------------------------------------------------------------------------------------

continued on next page

Table 2.1 continuation

	<p>C. All persons registering as qualified buyers shall, in addition, show proof that they possess the above- enumerated qualifications and submit under oath certified copies of the documents that show the following matters: (i) total portfolio of securities; (ii) annual gross income for the last two (2) years based on their income tax returns stamped-received by the BIR; (iii) their net worth; and (iv) threshold risk (low, medium, high risk). D. The registration as qualified buyers shall be valid for two years. It may renewed by the Commission upon favorable recommendation of an authorized registrar. For this purpose, the registrar shall maintain a registry which shall be open for inspection by the Commission. E. No securities acquired by qualified buyers shall be assigned, transferred or sold to investors who do not possess similar qualifications.</p>	
	<p>I) The sale of securities to any number of the following qualified buyers: (i) Bank; (ii) Registered investment house; (iii) Insurance company; (iv) Pension fund or retirement plan maintained by the Government of the Philippines or any political subdivision thereof or managed by a bank or other persons authorized by the Bangko Sentral to engage in trust functions; (v) Investment company; or (vi) Such other person as the Commission may by rule determine as qualified buyers, on the basis of such factors as financial sophistication, net worth, knowledge, and experience in financial and business matters, or amount of assets under management.</p>	
<p>Rule 10.2</p>	<p>The Commission may exempt other transactions, if it finds that the requirements of registration under this Code is not necessary in the public interest or for the protection of the investors such as by reason of the small amount involved or the limited character of the public offering.</p>	
	<p>Amended Implementing Rules and Regulations (IRR) of The Securities Regulation Code (Signed version of the Amended IRR published February 2004)</p>	<p>Draft version of the Revised Implementing Rules and Regulations (IRR) of The Securities Regulation Code (Posted February 2011 for public comment. Public comments were closed on March 15, 2011)</p>
	<p>Rule 10.2 – None.</p>	<p>Rule 10.2 – Small or Limited Public Offerings</p>
	<p>None.</p>	<p>1. An offering of securities shall be considered as small amount if the aggregate amount of securities covered by the application for exemption is less than five percent (5%) of the Issuer’s total net assets and that the number of shares covered by the application for exemption does not exceed five percent (5%) of the outstanding shares of the same class of the Issuer.</p> <p>2. For a public offering to be considered of limited character, the covered securities should be available only to the parties or persons named in the application for exemption for a specified period.</p> <p>3. The following documents shall be submitted in support of an application for exemption under Section 10.2 of the Code: A. Letter-request which shall contain the following information:</p>

continued on next page

Table 2.1 continuation

		<p>(i) Registered name of the applicant; (ii) Primary purpose of the applicant; (iii) Number of option shares to be issued; (iv) Profile of the optionees or persons to whom the offer shall be made; (v) Latest audited financial statement of the applicant; (vi) If applicable, the names and addresses of the applicant's subsidiaries and affiliate companies and their dates of registration with the Commission; issue price or exchange rate, including its source or basis, of the option shares at the time of filing; and last quoted price of the option shares.</p> <p>B. Notarized certificate of the corporate secretary of the applicant attesting to the following: (i) Approval by the applicant's board of directors and stockholders of the stock offering plan ("the Plan"); (ii) Genuineness and due execution of the Plan, a copy of which shall be attached to the certificate; and (iii) If applicable, a breakdown of the number of shares earlier exempted from registration, the shares subscribed by the optionees, and the remaining unissued shares computed on a year-to-year basis, and an explanation on why the applicant has renewed its application in spite of the availability of unissued shares.</p> <p>4. Issuers of securities of small or limited character that are granted exemption under this Rule shall submit to the Commission, on an annual basis, the amount of securities issued and the persons to whom the same were issued, or such other reports and for such period as the Commission may from time to time require.</p> <p>5. Applications for exemption filed under this Rule shall pay a filing fee in such amount as may be prescribed by the Commission.</p>
<p>Rule 10.3</p>	<p>Any person applying for an exemption under this Section, shall file with the Commission a notice identifying the exemption relied upon on such form and at such time as the Commission by rule may prescribe and with such notice shall pay to the Commission a fee equivalent to one-tenth (1/10) of one percent (1%) of the maximum aggregate price or issued value of the securities.</p>	
<p>SEC.12. Procedure for Registration of Securities. Rule 12.1</p>	<p>All securities required to be registered under Subsection 8.1 shall be registered through the filing by the issuer in the main office of the Commission, of a sworn registration statement with respect to such securities, in such form and containing such information and documents as the Commission shall prescribe. The registration statement shall include any prospectus required or permitted to be delivered under Subsections 8.2, 8.3 and 8.4.</p>	
<p>^a Known as Private Placement. Source: SEC.</p>		

Likewise, no information relating to the offering of securities shall be disseminated unless a registration statement (RS) has been filed with the SEC, along with a preliminary prospectus of the securities intended to be sold and distributed to the public.

If the securities, which are the subject of the RS, are intended to be listed in an exchange, a copy of said RS and all other pertinent documents shall also be filed with that exchange.

The application for the listing shall also be filed with the SEC.

The registrant may circulate a preliminary prospectus to prospective buyers of the securities upon filing the RS, even before SEC renders the RS as effective. The preliminary prospectus should prominently state that the RS pertaining to the securities has been filed but has not yet been approved by the SEC, and that the said prospectus does not constitute an offer to sell or a solicitation of an offer to buy. Both the preliminary and final prospectus shall be worded in plain language understandable to an ordinary person. The registrant shall also be able to show that the prospectuses were made readily available to those who want a copy in sufficient number.

The sale of securities, whose RS has been applied for, shall be commenced within 2 business days from the date of effectivity of the RS, and shall be continued until the end of the offering period or until sale has been terminated by action of the issuer.

A written notice of completion or termination of the offering shall be filed with the SEC within 3 business days, indicating the number of securities sold.

If the remaining registered but unsold securities shall be offered after the completion or termination of the sale, an updated RS shall be filed with the SEC prior to said offering or sale.

a. Exemptions from Registration

Exemption from registration with the SEC may pertain to securities (Section 9.1, SRC) or transactions (Section 10.1, SRC). Refer to Table 2.1 for details.

The exempt securities (Section 9.1, SRC) are as follows:

- (a) Any security issued or guaranteed by the Government of the Philippines, or by any political subdivision or agency thereof, or by any person controlled or supervised by, and acting as an instrumentality of said Government.
- (b) Any security issued or guaranteed by the government of any country with which the Philippines maintains diplomatic relations, or by any state, province or political subdivision thereof on the basis of reciprocity: Provided, That the Commission may require compliance with the form and content of disclosures the Commission may prescribe.
- (c) Certificates issued by a receiver or by a trustee in bankruptcy duly approved by the proper adjudicatory body.
- (d) Any security or its derivatives the sale or transfer of which, by law, is under the supervision and regulation of the Office of the Insurance Commission, Housing and Land Use Regulatory Board, or the Bureau of Internal Revenue.
- (e) Any security issued by a bank except its own shares of stock.

On the other hand, exempt transactions (Section 10.1, SRC) are summarized as follows: (See details in Table 2.1).

- (a) Judicial sales or sales by an executor, administrator, guardian, receiver, or trustee in insolvency or bankruptcy
- (b) Sales made pursuant to the foreclosure of a pledge or mortgage

- (c) Isolated transactions
- (d) Payment of stock dividends
- (e) Sale of capital stock by a company to its own stockholders exclusively without any paid remuneration or commission
- (f) Issuance of bonds or notes secured by a mortgage to a single purchaser
- (g) Conversion of previously registered convertible securities
- (h) Broker's transactions on a registered exchange or trading market
- (i) Pre-incorporation subscription or subscription to increase a company's authorized capital stock
- (j) Exchange of securities by the issuer with its existing security holder exclusively without remuneration
- (k) Sale of securities by an issuer to less than 20 persons in the Philippines during any 12-month period, also known as private placement
- (l) Sale to qualified buyers
See details in Table 2.1.

A Notice of Exemption on SEC Form 10-1 shall be required in an offering or distribution of securities under Section 10.1(k) and (l) of the SRC.

Any person claiming exemption under Section 10 of the SRC shall provide a written disclosure stating the exemption relied upon to any other person whom it offers to sell securities relying on any of the exemptions mentioned above. The written disclosure shall also indicate whether SEC's confirmation has been obtained that such offer or sale qualifies as an exempt transaction.

b. Commercial Papers Registration

The conditions for the registration of commercial papers (CPs) issued by corporations to the public are provided under SRC Rule 12.1, the salient points of which are as follows:

- (i) RS (Registration Statement) under SEC Form 12-1 in accordance with SRC Rules 8.1 and 12.1.
- (ii) Firm commitment underwriting agreement for the CP with a universal bank, investment house, or any other financial institution duly licensed under the Investment Houses Law.
- (iii) A commercial paper issue shall be rated by a rating agency accredited by the SEC, except for issuance amounting to not more than 25% of the issuer's net worth. A rating shall also be made where there is an irrevocable committed credit line with a bank covering 100% of the proposed issuance.
- (iv) Payment of a filing fee, which shall be based on the total amount of CP proposed to be issued, and shall be subject to a diminishing fee in accordance with SEC Form 12-1.

Furthermore, SRC Rule 12.1 requires the issuer to comply with the conditions imposed for the registration of its CPs for the duration of the effectivity of the RS covering said securities. Failure to satisfy these conditions shall be sufficient ground, after notice and hearing, for the revocation or suspension of said registrations.

Registration of short-term CPs shall be valid for less than 1 year and may be renewed annually with respect to the unissued balance of the authorized amount upon demonstration of strict compliance with the SRC and applicable rules. The application for renewal of registration shall be filed at least 45 days before expiry date.

On the other hand, registration of long-term CPs shall be a closed-end process where the issued portion of the authorized amount may no longer be subject to re-issuance to the public, unless re-applied for registration in accordance with the rules.

Long-term CPs, except bonds, which have a maturity period of 5 years or more, shall not be pre-terminated by the issuer or lender within 730 days from the date of issue. Pre-termination shall include optional redemption, partial installments, and amortization payments.

It should be noted that the given rules do not constitute an exemption or a waiver of applicable BSP requirements governing the performance of quasi-banking functions of financial intermediaries duly authorized to engage in such activities. Thus, all applications covering the registration of CPs to be issued for relending purposes shall be endorsed by the SEC to the BSP. Otherwise, only SEC approval is necessary.

An issuer of commercial papers under an exempt transaction shall:

- a) File a Notice or Application for Confirmation of Exemption (SEC Form 10-1) prior to issuance thereof. The said application shall be accompanied by the prescribed filing fees and include a disclosure of the following financial ratios:
 - (i) Current Ratio = Current Assets/Current Liabilities
 - (ii) Acid Test Ratio = Cash, receivables and marketable securities/Current Liabilities
 - (iii) Net Profit Margin = Net income after income tax/Net Sales or revenues
 - (iv) Return on Equity = Net income after income tax/Total Stockholders' Equity Interest Service
 - (v) Charge Ratio = Net income before interest expense/Interest Expense
 - (vi) Debt to equity ratio = Total Liabilities/Stockholders' Equity

Above Exempt Commercial Paper Transaction is currently proposed to be changed to:

- b) File a Notice or Application for Confirmation of Exemption (SEC Form 10-1) prior to issuance. The application shall make a disclosure of the following financial ratios:
 - (i) Current Ratio = Current Assets/Current Liabilities
 - (ii) Debt to equity Ratio = Total Liabilities/Stockholders' Equity

c. Availability of Shelf Registration and Associated Documentation Requirements

Under SRC Rule 8.1 on the Requirement to file an RS, if the remaining registered but unsold securities shall be offered after the completion or termination mentioned under paragraph 1D,³⁶ an updated RS shall be filed with the SEC prior to the said offering or sale.

³⁶ Paragraph 1D of the SRC Rule 8.1 states that [a] A written notification of completion or termination of the offering shall be filed with the Commission within three (3) business days from such completion or termination, indicating therein the number of securities sold.

D. Rules and Regulations on Buying Debt Instruments and Investment in Debt Securities

1. Rules or Requirements for Continuous Disclosure

There are no restrictions for investors who would want to purchase debt instruments.

2. Definition of Qualified Institutional Investors

Please also refer to Chapter I, P.2.a “Qualified Investor (qualified buyer)”.

a. Qualified Buyer

According to SEC OTC Rules,³⁷ “qualified investor” refers to any of the qualified buyers defined under Section 10.1 (L) of the SRC, as follows:

- (i) Banks;
- (ii) Registered investment houses;
- (iii) Insurance companies;
- (iv) Pension funds or retirement plans maintained by the Government of the Philippines or any of its political subdivisions, or managed by a bank or other persons authorized by the BSP to engage in trust functions;
- (v) Investment companies; or
- (vi) Other persons as the SEC may determine, by rule, as qualified buyers on the basis of financial sophistication, net worth, knowledge and experience in financial and business matters, or amount of assets under management.

Qualified investors may also be any of the institutional accounts defined in SRC Rule 52.1,³⁸ which include:

- (i) A bank, insurance company, or registered investment company;
- (ii) Any other entity set forth in Section 10.1(L) of the SRC³⁹ as a qualified buyer; or
- (iii) Any other entity (whether a natural or juridical person, corporation, partnership, trust, or otherwise) with total assets of at least PHP1.2 billion; provided, however, that the broker or dealer shall obtain from such entity a declaration, under oath, confirming ownership of such assets;
- (iv) Other persons declared by the SEC by way of rule or order as a qualified investor taking into consideration such person’s net worth or financial background that would enable him to bear the risk that may arise from participating in an over the counter (OTC) market.

b. Qualified Individual Buyer

To implement the provisions of Section 10.1(L)(vi) of the SRC, SEC issued *Memorandum Circular No. 6, Series of 2007* (Qualified Buyer Rules)⁴⁰ on 10 December 2007. Under

³⁷ Footnote 11.

³⁸ According to SRC Rule 52.1, the term “institutional account” shall mean the account of:

- (i) A bank, insurance company, or registered investment company;
- (ii) Any other entity set forth in Section 10.1(l) of the Code as a qualified buyer; or
- (iii) Any other entity (whether a natural person, corporation, partnership, trust or otherwise) with total assets of at least =PHP1,200,000,000; provided, however, that the Broker Dealer shall obtain from such entity a declaration, under oath, confirming ownership of such assets.

³⁹ Footnote 9.

⁴⁰ SEC. 2006. “Definition of Qualified Buyers under Section 10 of the Securities Regulation Code.” SEC Memorandum Circular No. 6, Series of 2006. <http://www.sec.gov.ph/circulars/cy,2007/sec-memo-06,s2007.pdf>

the circular, the SEC distinguishes a qualified individual buyer from a “qualified institutional buyer.” A qualified individual buyer is a natural person who, at the time of his or her registration with an SRO, or such other entities that the SEC may authorize to make the registration, possesses the following qualifications:

- a. Has a minimum annual gross income of PHP25 million for at least 2 years prior to registration, or a total portfolio investment in securities registered with the SEC of at least PHP10 million, or a personal net worth of not less than PHP30 million); and
- b. Has been legally engaged in securities trading, in his personal capacity, or through a fund manager, for a period of 1 year; or held for at least 2 years a position of responsibility in any professional or business entity that requires knowledge or expertise in securities trading, such as legal consultant, financial adviser, sales person, or associated person of broker-dealer, or finance, treasury or trust officer of a bank, or other executive positions with related responsibilities.

c. Prospective Qualified Buyer

Under the Qualified Buyer Rules, prospective qualified buyers, whether institutional or individual, who possess all the qualifications and wish to become qualified buyers shall file their application for registration with an accredited registrar of qualified buyers.

d. Qualified Institutional Buyer

On the other hand, a qualified institutional buyer is one that possesses any of the following qualifications at the time of its registration:

- (i) Has a minimum annual gross income of at least PHP100 million for at least 2 years prior to registration;
- (ii) A total portfolio investment in securities registered with the SEC of at least PHP60 million; and
- (iii) A net worth of not less than PHP100 million.

e. Non-Qualified Investor

Meanwhile, the OTC Rules⁴¹ simply define non-qualified investors as:

- (i) Those that do not fall under the classification of qualified investors; and
- (ii) Qualified investors that do not want to participate in the OTC market as qualified investors.

The consequence under the OTC Rules is that a qualified investor can directly buy or sell securities in an OTC market while a non-qualified investor cannot participate in an OTC market, unless such participation is through an intermediary such as a broker, investment house, or bank in its capacity as a broker; or through participation in a mutual fund, pension fund, or non-directional trust fund.

⁴¹ SEC Memorandum Circular No. 14, Series of 2006, “Rules Governing the Over-the-Counter (OTC) Market” is available from the following website: <http://www.sec.gov.ph/circulars/cy,2006/sec-memo-14,s2006.pdf>

The Implementing Rules and Regulations (IRR) of the SRC (SRC Rules) likewise recognize the following as primary institutional lenders, and do not require registration of instruments issued to the following:

- (i) Banks,
- (ii) Bank trust accounts wherein the bank-trustee is granted discretionary powers in the investment disposition of the trust funds,
- (iii) Investment houses,
- (iv) Investment houses and their trust accounts wherein the investment house-trustee is granted discretionary powers in the investment disposition of the trust funds,
- (v) Trust companies,
- (vi) Financing companies,
- (vii) Investment companies,
- (viii) Pre-need companies,
- (ix) Non-stock savings and loan associations,
- (x) Building and loan associations,
- (xi) Venture capital corporations,
- (xii) Insurance companies,
- (xiii) Government financial institutions,
- (xiv) Pawnshops,
- (xv) Pension and retirement funds approved by the Bureau of Internal Revenue (BIR),
- (xvi) Educational assistance funds established by the national government, and
- (xvii) Other entities that the BSP, in consultation with the SEC, classifies as primarily institutional lenders. Conditions to this include (a) all evidence of indebtedness shall only be negotiated or assigned to any of the primary institutional lenders, such as the Development Bank of the Philippines, with respect to private development banks in relation with their rediscounting privileges; (b) in case of non-banks without underwriting licenses, such negotiation or assignment shall be through banks or non-banks licensed to be an underwriter or a securities dealer; and (c) that in no case shall the said instruments be negotiated or assigned to non-qualified investors.

For more discussion on qualified investor (qualified buyer), please refer to I.P.2a of this market guide

3. Requirements and Restrictions for Non-Resident Investors

BSP regulations on inward foreign investments are found in Section 32 to 44 of the *Manual of Regulations on Foreign Exchange Transactions* (FX Manual) 1.⁴² These may be in the form of:

- (i) Foreign direct investments (FDIs), in cash or in kind, in Philippine firms or enterprises;
- (ii) Investments in peso-denominated government securities;
- (iii) Investments in securities listed in the Philippine Stock Exchange (PSE);

⁴² Section 32 to 44 can be found in the Part 2, Chapter II on Foreign Investments of the *Manual of Regulations on Foreign Exchange Transactions*. Full text of the FX Manual is available in the Bangko Sentral ng Pilipinas (BSP) website: <http://www.bsp.gov.ph/downloads/Regulations/MORFXT/MORFXT.pdf>;

- (iv) Investments in money-market instruments;⁴³ and
- (v) Investments in peso time deposits with authorized agent banks (AABs) with a minimum maturity of 90 days.

Investments may be registered with the BSP Head Office through the International Operations Department (IOD) or with custodian banks in the Philippines to allow capital repatriation and remittance of profits, dividends and earnings to be funded with foreign exchange sourced from AABs or AAB foreign exchange corps.⁴⁴

Such minimum requirements include the original certificate of inward remittance of foreign exchange Bangko Sentral Remittance Document (BSRD) in the BSP-prescribed format, which contains information on the inward remittance of foreign exchange and its conversion to pesos through an AAB.

However, a foreign investor, or his or her authorized representative, can opt to register the foreign investments with the BSP.

For this purpose, the minimum documentary requirements must comply with the requirements provided under Appendix 10 of the FX Manual. Such minimum requirements include the original certificate of inward remittance of Foreign Exchange Bangko Sentral Remittance Document (BSRD) in the BSP-prescribed format, which contains information on the inward remittance of foreign exchange and its conversion to pesos through an AAB.

4. Resident Investor Requirements and Restrictions

Under Section 44 of the FX Manual, residents can freely purchase foreign exchange from AABs and/or AAB-foreign exchange corporations for investments abroad. These include investments in bonds and/or notes of the Republic of the Philippines or other Philippine-resident entities requiring settlement in foreign currency. An investor, or a fund of qualified investors, can invest up to USD60 million, or its equivalent, per year.

E. Investor Protection

1. Bondholders Rights

The *Insolvency Law* and Civil Code cover bondholder rights. Claims of creditors against debtors through insolvency proceedings fall under the *Insolvency Law*. Meanwhile, the Civil Code prescribes the order of payments to different types of creditors in the event of liquidation of a debtor's estate. The same rules apply to domestic and foreign bondholders.

⁴³ These include peso-denominated debt instruments, such as but not limited to bonds and notes, bills payables, and non-participating preferred shares issued onshore by private resident firms and not included in Section 23 of the FX Manual.

⁴⁴ Foreign direct investment, peso-denominated government securities, securities listed in the Philippine Stock Exchange (PSE), and money-market instruments are registered with the BSP's International Operations Department (IOD). Registration for peso-denominated government securities and securities listed in the PSE, as well as peso-time deposits with authorized agent banks (AABs) are filed with custodian banks.

2. Prevention of Fraud

Section 24 (Manipulation of Security Prices Devices and Practices) of the SRC⁴⁵ and SRC Rules prohibit fraudulent and manipulative transactions.

F. Regulatory Reporting Requirements

Reportorial requirements are provided under SRC Chapter V (Reportorial Requirements) and corresponding SRC Rule 17.1. Refer to Tables 2.2 and 2.3.

A summary or salient points of the SRC Chapter V (Reportorial Requirements) and SRC Rule 17.1 are as follows:

- (i) As a general rule, every issuer shall file an annual report and quarterly report with the SEC using SEC Forms.
- (ii) Every issuer shall file the same report with the exchange where the issuer is listed within 10 minutes after the event has occurred and prior to the report’s release to the public through the news media. A copy of the report shall be provided to the SEC.
- (iii) Any disclosure signed and filed with the SEC and with the exchange where the securities are listed, or released through mass media—in the personal capacity of any director, executive officer, or a substantial stockholder (as defined under SRC Rule 38.1) directly or indirectly—by an issuer shall be considered as part of any report mentioned above, and deemed as an official filing of such company if it does not deny the subject information within 2 days from the filing and/or release of the aforementioned disclosure. Any misleading statement, misrepresentation, or omission of a material fact shall be the joint responsibility of the issuer and the reporting director, officer, or substantial stockholder.

An owner of more than 5% of the voting rights of a listed company, or any related person, who holds material information which may materially affect such company, may be required by the SEC to disclose such information within the period prescribed under SRC Rule 17.1. Failure to provide the required information shall subject the said stockholder to sanctions applicable to violations of this rule.

Table 2.2 Securities Regulation Code Chapter V: Reportorial Requirements

REPUBLIC ACT NO. 8799 THE SECURITIES REGULATION CODE (SRC) 17 July 2000	
CHAPTER V	Reportorial Requirements
SEC. 17.	Periodic and Other Reports of Issuers.
17.1.	Every issuer satisfying the requirements in Subsection 17.2 hereof shall file with the Commission: <ul style="list-style-type: none"> a) Within one hundred thirty-five (135) days, after the end of the issuer’s fiscal year, or such other time as the Commission may prescribe, an annual report which shall include, among others, a balance sheet, profit and loss statement and statement of cash flows, for such last fiscal year, certified by an independent certified public accountant, and a management discussion and analysis of results of operations; and b) Such other periodical reports for interim fiscal periods and current reports on significant developments of the issuer as the Commission may prescribe as necessary to keep current information on the operation of the business and financial condition of the issuer.

continued on next page

⁴⁵ Footnote 9; Footnote 24.

Table 2.2 continuation

REPUBLIC ACT NO. 8799 THE SECURITIES REGULATION CODE (SRC) 17 July 2000	
17.2.	The reportorial requirements of Subsection 17.1 shall apply to the following: a) An issuer which has sold a class of its securities pursuant to a registration under Section 12 hereof: Provided, however, That the obligation of such issuer to file reports shall be suspended for any fiscal year after the year such registration became effective if such issuer, as of the first day of any such fiscal year, has less than one hundred (100) holders of such class of securities or such other number as the Commission shall prescribe and it notifies the Commission of such; b) An issuer with a class of securities listed for trading on an Exchange; and c) An issuer with assets of at least Fifty million pesos (P50,000,000.00) or such other amount as the Commission shall prescribe, and having Two hundred (200) or more holders each holding at least One hundred (100) shares of a class of its equity securities: Provided, however, That the obligation of such issuer to file reports shall be terminated ninety (90) days after notification to the Commission by the issuer that the number of its holders holding at least one hundred (100) shares is reduced to less than One hundred (100).
17.3.	Every issuer of a security listed for trading on an Exchange shall file with the Exchange a copy of any report filed with the Commission under Subsection 17.1 hereof.
17.4.	All reports (including financial statements) required to be filed with the Commission pursuant to Subsection 17.1 hereof shall be in such form, contain such information and be filed at such times as the Commission shall prescribe, and shall be in lieu of any periodical or current reports or financial statements otherwise required to be filed under the Corporation Code.
17.5.	Every issuer which has a class of equity securities satisfying any of the requirements in Subsection 17.2 shall furnish to each holder of such equity security an annual report in such form and containing such information as the Commission shall prescribe.
17.6.	Within such period as the Commission may prescribe preceding the annual meeting of the holders of any equity security of a class entitled to vote at such meeting, the issuer shall transmit to such holders an annual report in conformity with Subsection 17.5.
SEC. 18.	Reports by Five per centum (5%) Holders of Equity Securities.
18.1.	In every case in which an issuer satisfies the requirements of Subsection 17.2 hereof, any person who acquires directly or indirectly the beneficial ownership of more than five per centum (5%) of such class or in excess of such lesser per centum as the Commission by rule may prescribe, shall, within ten (10) days after such acquisition or such reasonable time as fixed by the Commission, submit to the issuer of the security, to the Exchange where the security is traded, and to the Commission a sworn statement containing the following information and such other information as the Commission may require in the public interest or for the protection of investors: a) The personal background, identity, residence, and citizenship of, and the nature of such beneficial ownership by, such person and all other persons by whom or on whose behalf the purchases are effected; in the event the beneficial owner is a juridical person, the lines of business of the beneficial owner shall also be reported; b) If the purpose of the purchases or prospective purchases is to acquire control of the business of the issuer of the securities, any plans or proposals which such persons may have that will effect a major change in its business or corporate structure; c) The number of shares of such security which are beneficially owned, and the number of shares concerning which there is a right to acquire, directly or indirectly, by: (i) such person, and (ii) each associate of such person, giving the background, identity, residence, and citizenship of each such associate; and d) Information as to any contracts, arrangements, or understanding with any person with respect to any securities of the issuer including but not limited to transfer, joint ventures, loan or option arrangements, puts or calls, guarantees or division of losses or profits, or proxies naming the persons with whom such contracts, arrangements, or understanding have been entered into, and giving the details thereof.
18.2.	If any change occurs in the facts set forth in the statements, an amendment shall be transmitted to the issuer, the Exchange and the Commission.
18.3.	The Commission, may permit any person to file in lieu of the statement required by Subsection 17.1 hereof, a notice stating the name of such person, the shares of any equity securities subject to Subsection 17.1 which are owned by him, the date of their acquisition and such other information as the Commission may specify, if it appears to the Commission that such securities were acquired by such person in the ordinary course of his business and were not acquired for the purpose of and do not have the effect of changing or influencing the control of the issuer nor in connection with any transaction having such purpose or effect.

Source: Republic of the Philippines. Securities and Exchange Commission (SEC). 2000. *Republic Act 8799 (Securities Regulation Code)*. <http://www.sec.gov.ph/index.htm?src/index>

Table 2.3 Securities Regulation Code Rule 17.1 Reportorial Requirements (Signed Version and Draft Version)

AMENDED IMPLEMENTING RULES AND REGULATIONS (IRR) OF THE SECURITIES REGULATION CODE (Signed version of the Amended IRR published February 2004)		Draft version of the Revised Implementing Rules and Regulations (IRR) of The Securities Regulation Code (Posted February 2011 for public comment. Public comments were closed on March 15, 2011)	
SRC Rule 17.1	Reportorial Requirements	Rule 17.1	Reportorial Requirements
1. Reporting and Public Companies	<p>The reportorial provisions of this paragraph shall apply to reporting and public companies, as defined under SRC Rule 3. However, the obligation of a company, which has sold a class of its securities pursuant to a registration under Section 12 of the Code shall be suspended for any fiscal year if as of the first day of any such fiscal year, it has less than one hundred (100) holders of such class of securities and the Commission is duly notified of the same. Such suspension shall only be availed of after the year said registration becomes effective.</p> <p>A. Every issuer set forth in paragraph 1 hereof, shall file with the Commission:</p> <p>i. An annual report on SEC Form 17-A for the fiscal year in which the registration statement was rendered effective by the Commission, and for each fiscal year thereafter, within one hundred five (105) days after the end of the fiscal year.</p> <p>ii. A quarterly report on SEC Form 17-Q, within forty five (45) days after the end of each of the first three quarters (3) of each fiscal year. The first quarterly report of the issuer shall be filed either within forty five (45) days after the effective date of the registration statement or on or before the date on which such report would have been required to be filed if the issuer had been required previously to file reports on SEC Form 17-Q, whichever is later.</p> <p>iii. 1. a current report on SEC Form 17-C, as necessary, to make a full, fair and accurate disclosure to the public of every material fact or event that occurs, which would reasonably be expected to affect investors' decisions in relation to those securities. In the event a news report appears in the media involving an alleged material event, a current report shall be made within the period prescribed herein, in order to clarify said news item, which could create public speculation if not officially denied or clarified by the concerned company. 2. The disclosure required by paragraph 1(A)(iii)(1) above shall be made by the issuer: a. promptly to the public through the news media; b. if the issuer is listed on an Exchange, to that Exchange within ten (10) minutes after occurrence of the event and prior to its release to the public through the news media, copy furnished the Commission;</p>	1. Public and Reporting Companies	<p>This paragraph shall apply to all public and reporting companies as defined in Rule 3. However, the obligation of a company which has sold a class of its securities pursuant to a registration under Section 12 of the Code shall be suspended for any fiscal year if, as of the first day of any such fiscal year, it has less than one hundred (100) holders of such class of securities and the Commission is notified of that fact. The suspension shall be availed of only after the year the registration became effective.</p> <p>A. The public and reporting companies shall file with the Commission:</p> <p>(i) An annual report on SEC Form 17-A for the fiscal year in which the registration statement was rendered effective by the Commission, and for each fiscal year thereafter, within one hundred five (105) business days after the end of the fiscal year.</p> <p>(ii) A quarterly report on SEC Form 17-Q within forty five (45) business days after the end of each of the first three quarters of each fiscal year. The first quarterly report of the Issuer shall be filed either within forty five (45) business days after the effective date of the registration statement or on or before the date on which such report would have been required to be filed if the Issuer had been required previously to file reports on SEC Form 17-Q, whichever is later.</p> <p>(iii) [a] A current report on SEC Form 17-C, as may be necessary, to make a full, fair and accurate disclosure to the public of every material fact or event that occurs which would reasonably be expected to affect the investors' decisions in relation to those securities. In the event a news report appears in the media involving an alleged material event, a current report shall be made within the period prescribed herein in order to clarify the said news item which may create public speculation if not officially denied or clarified by the concerned company. [b] The disclosure required by paragraph 1(A)(iii)[a] above shall be made by the company in accordance with the following guidelines: (1) promptly to the public through the news media; (2) if the company is listed on an Exchange, to that Exchange within ten (10) minutes after the occurrence of the event and prior to its release to the public through the news media, copy furnished the Commission;</p>

continued on next page

Table 2.3 continuation

<p>c. to the Commission on SEC Form 17-C within five (5) days after occurrence of the event being reported, unless substantially similar information as that required by Form 17-C has been previously reported to the Commission by the registrant.</p> <p>3. An illustrative, non-all inclusive, list of events which shall be reported pursuant to this paragraph is contained in SEC Form 17-C. Merely because an event does not appear in that list does not mean that it does not have to be reported if, in fact, it is material.</p> <p>iv. In addition to the above reports, issuers of registered commercial papers shall file the following in the form prescribed by the Commission until all the outstanding commercial papers have been paid:</p> <ol style="list-style-type: none"> 1. Monthly reports (M-101-40) on commercial paper total issuances/outstanding as at the end of each month, to be submitted within ten (10) business days following the end of the reference month; 2. A list of issuances, outstanding balance and maturing commercial papers as at the end of each quarter, to form part of the required SEC Form 17-Q. <p>The obligation to file reports under this item shall not be suspended even when the number of holders of the issuer's commercial papers shall be reduced to less than one hundred (100).</p> <p>B. Any disclosure signed and filed with the Commission and the Exchange where the securities of the issuer are listed, or released in mass media, in the personal capacity of any director, executive officer or a substantial stockholder (as defined under SRC Rule 38.1) direct or indirect, of an issuer shall be considered as part of any report mentioned in paragraph 1(A)(iii) hereof and deemed as an official filing of such company if it does not deny the subject information within two (2) days from the filing/ release of the aforementioned disclosure. Any misleading statement, misrepresentation or omission of a material fact therein shall be the joint responsibility of the issuer and the reporting director, officer or substantial stockholder.</p> <p>C. An owner of more than five percent (5%) of the voting rights of a listed company or any related party thereof, who holds material information which may materially affect such company may be required by the Commission to disclose such information within the period prescribed under paragraph 1(A)(iii) of this Rule. Failure to provide the required information shall subject said stockholder to sanctions applicable to violations of this Rule.</p>	<p>(3) if it is not listed, to the Commission through SEC Form 17-C within five (5) business days after the occurrence of the event reported, unless substantially similar information as that required by Form 17-C has been previously reported to the Commission by the company.</p> <p>B. Any disclosure signed and filed with the Commission and the Exchange where the securities of the Issuer are listed, or released to the news media by any director, executive officer or a substantial stockholder (as defined under Rule 38.1) of an Issuer shall be considered as part of any report mentioned in paragraph 1(A)(iii) above and deemed as an official filing of such company if it does not deny the subject information within two (2) business days from the filing or release of the disclosure. Any misleading statement, misrepresentation or omission of a material fact therein shall be considered the joint responsibility of the Issuer and the reporting director, officer or substantial stockholder.</p> <p>C. An owner of more than five percent (5%) of the voting rights of a public and reporting company that meets the requirements of Section 17.2 of the Code who holds material information which may materially affect such company may be required by the Commission to disclose such information within the period prescribed under paragraph 1(A)(iii) of this Rule. Failure to provide the required information shall subject the said stockholder to the sanctions applicable to violations of this Rule.</p> <p>D. Issuers of securities registered with the Commission shall file an annual report on SEC Form 17-A for its predecessors that registered securities with the Commission during the last full fiscal year of the predecessor prior to the registrant's succession, unless such report has already been filed by the predecessor. The annual report shall contain the information required if it were filed by the predecessor.</p> <p>E. In the event a non-reporting Issuer (in connection with succession by merger, consolidation, exchange of securities or acquisition of assets) issues equity securities to holders of equity securities issued by a reporting Issuer, the non-reporting Issuer shall assume the same obligation as the reporting Issuer to file reports pursuant to Section 17 of the Code, and the nonreporting Issuer shall file such reports on the same forms as the reporting Issuer.</p> <p>F. Notification of Inability to File on Time All or Any Required Portion of SEC Form 17-A or 17-Q.</p>
----------------------------------------------------------------------------------------------------------------------------------------------------------------------------------------------------------------------------------------------------------------------------------------------------------------------------------------------------------------------------------------------------------------------------------------------------------------------------------------------------------------------------------------------------------------------------------------------------------------------------------------------------------------------------------------------------------------------------------------------------------------------------------------------------------------------------------------------------------------------------------------------------------------------------------------------------------------------------------------------------------------------------------------------------------------------------------------------------------------------------------------------------------------------------------------------------------------------------------------------------------------------------------------------------------------------------------------------------------------------------------------------------------------------------------------------------------------------------------------------------------------------------------------------------------------------------------------------------------------------------------------------------------------------------------------------------------------------------------------------------------------------------------------------------------------------------------------------------------------------------------------------------------------------------------------------------------------------------------------------------------------------------------------------------------------------------------------------------------------------------------------------------------------------------------------------------------------------------------------------------------------------------------------------------------------------------------------------------------------------------------------------------------------------------------------------------------------------------------------------------------------------------------------------------------------------------------------------------------------------------------------------	----------------------------------------------------------------------------------------------------------------------------------------------------------------------------------------------------------------------------------------------------------------------------------------------------------------------------------------------------------------------------------------------------------------------------------------------------------------------------------------------------------------------------------------------------------------------------------------------------------------------------------------------------------------------------------------------------------------------------------------------------------------------------------------------------------------------------------------------------------------------------------------------------------------------------------------------------------------------------------------------------------------------------------------------------------------------------------------------------------------------------------------------------------------------------------------------------------------------------------------------------------------------------------------------------------------------------------------------------------------------------------------------------------------------------------------------------------------------------------------------------------------------------------------------------------------------------------------------------------------------------------------------------------------------------------------------------------------------------------------------------------------------------------------------------------------------------------------------------------------------------------------------------------------------------------------------------------------------------------------------------------------------------------------------------------------------------------------------------------------------------------------------------------------------------------------------------------------------------------------------------------------------------------------------------------------------------------------------------------------------------------------------------------------------------------------------------------------------------------------------------------------------------------------------------------------------------------------------

continued on next page

Table 2.3 continuation

<p>D. Every issuer having securities registered with the Commission shall file an annual report on SEC Form 17-A for each of its predecessors which had securities registered with the Commission covering the last full fiscal year of the predecessor prior to the registrant's succession, unless such report has been filed by the predecessor. Such annual report shall contain the information that would be required if filed by the predecessor.</p> <p>E. In the event that a non-reporting issuer (in connection with succession by merger, consolidation, exchange of securities or acquisition of assets) issues equity securities to holders of equity securities issued by a reporting issuer, the non-reporting issuer shall assume the same obligation as the reporting issuer to file reports pursuant to Section 17 of the Code, and the non-reporting issuer shall file such reports on the same forms as the reporting issuer.</p> <p>F. Notification of Inability to File On Time All or Any Required Portion of SEC FORM 17-A or 17-Q</p> <p>i. If all or any required portion of an annual report (SEC Form 17-A) or quarterly report (SEC Form 17-Q) required to be filed pursuant to Section 17 of the Code and SRC Rule 17.1 thereunder is not filed within the period prescribed for such report, the issuer shall, no later than the due date for such report, file with the Commission and, if applicable, with the Exchange where any class of its securities are listed, a SEC Form 17-L which shall contain a disclosure in reasonable detail of its inability to file the report timely and the reasons therefore. All information which are available on the date of the required filing shall be filed.</p> <p>ii. With respect to any report or portion of any report described in paragraph (A) above which is not timely filed because the issuer is unable to do so without unreasonable effort or expense, such report shall be deemed to be filed on the prescribed due date for such report if:</p> <ol style="list-style-type: none"> 1. The issuer files SEC Form 17-L in compliance with paragraph (i) hereof and, when applicable, furnishes the exhibit required by paragraph (iii) hereof; 2. The issuer represents in SEC Form 17-L that: <ol style="list-style-type: none"> a. The reason(s) causing the inability to file timely could not be eliminated by the issuer without unreasonable effort or expense; and b. Either the subject annual report on SEC Form 17-A, or portion thereof, will be filed no later than the fifteenth calendar day following the prescribed 	<p>(i) If all or any required portion of an annual report (SEC Form 17-A) or quarterly report (SEC Form 17-Q) required to be filed pursuant to Section 17 of the Code and Rule 17.1 is not filed within the period prescribed for such report, the Issuer shall, not later than the due date for such report, file with the Commission and, if applicable, with the Exchange where any class of its securities is listed, SEC Form 17-L which shall contain a disclosure in reasonable detail of its inability to timely file the report and the reasons for such failure. All information available on the date of the required filing shall be filed.</p> <p>(ii) If any report or portion of any report described in paragraph (A) above is not timely filed because the Issuer is unable to do so without unreasonable effort or expense, such report shall be deemed to be filed on the prescribed due date for such report if:</p> <ol style="list-style-type: none"> (a) The Issuer files SEC Form 17-L in compliance with paragraph (i) hereof and, if applicable, furnishes the document required by paragraph(iii) below; (b) The Issuer states in SEC Form 17-L that: (i) the reason(s) that caused the inability to timely file could not be eliminated by the Issuer without unreasonable effort or expense; (ii) either the subject annual report on SEC Form 17-A, or portion thereof, will be filed not later than the fifteenth calendar day following the prescribed due date, or the subject quarterly report on SEC Form 17-Q, or portion thereof, will be filed not later than the fifth calendar day following the prescribed due date; and (iii) the report or portion thereof is actually filed within the period specified by paragraph 1(A) above. <p>(iii) If paragraph (ii) above is applicable and the reason the subject report or portion thereof cannot be timely filed without unreasonable effort or expense relates to the inability of any person, other than the Issuer, to furnish any required opinion, report or certification, a statement signed by such person stating the specific reasons why that person is unable to furnish the required opinion, report or certification on or before the date must be filed with SEC Form 17-L.</p> <p>(iv) Notwithstanding paragraph (ii) above, a registration statement filed on SEC Form 12-1 pursuant to Rule 8.1, the use of which is predicated on timely filed reports, shall not be declared effective until the subject report is actually filed pursuant to paragraph (A) above.</p> <p>(v) If the Form 17-L filed pursuant to paragraph (ii) above relates only to a portion of a subject report, the Issuer shall:</p> <ol style="list-style-type: none"> (a) File the balance of such report and indicate on its cover page which disclosure items are omitted; and
-----------------------------------------------------------------------------------------------------------------------------------------------------------------------------------------------------------------------------------------------------------------------------------------------------------------------------------------------------------------------------------------------------------------------------------------------------------------------------------------------------------------------------------------------------------------------------------------------------------------------------------------------------------------------------------------------------------------------------------------------------------------------------------------------------------------------------------------------------------------------------------------------------------------------------------------------------------------------------------------------------------------------------------------------------------------------------------------------------------------------------------------------------------------------------------------------------------------------------------------------------------------------------------------------------------------------------------------------------------------------------------------------------------------------------------------------------------------------------------------------------------------------------------------------------------------------------------------------------------------------------------------------------------------------------------------------------------------------------------------------------------------------------------------------------------------------------------------------------------------------------------------------------------------------------------------------------------------------------------------------------------------------------------------------------------------------------------------------------------------------------------------------------------------------------------------------------------------------------------------------------------------------------------------------------------------------------------------------------------------------------------------------------------------------------------------------------------------------------------------------------------------------------------------------------------------------------------------------------------------------------------------------------------------------------------------	---------------------------------------------------------------------------------------------------------------------------------------------------------------------------------------------------------------------------------------------------------------------------------------------------------------------------------------------------------------------------------------------------------------------------------------------------------------------------------------------------------------------------------------------------------------------------------------------------------------------------------------------------------------------------------------------------------------------------------------------------------------------------------------------------------------------------------------------------------------------------------------------------------------------------------------------------------------------------------------------------------------------------------------------------------------------------------------------------------------------------------------------------------------------------------------------------------------------------------------------------------------------------------------------------------------------------------------------------------------------------------------------------------------------------------------------------------------------------------------------------------------------------------------------------------------------------------------------------------------------------------------------------------------------------------------------------------------------------------------------------------------------------------------------------------------------------------------------------------------------------------------------------------------------------------------------------------------------------------------------------------------------------------------------------------------------------------------------------------------------------------------------------------------------------------------------------------------------------------------------------------------------------------------------------------------------------------------------------------------------------------------------------------------------------------------------------------------------------------------------------------------------------------------------------------------------------------------------------------------------------------------------------------------------------------------------------------------------------------------------------------------------------------------------------------------------------------------------------------------------------------------------------------------------

continued on next page

Table 2.3 continuation

<p>2. Issuers of Exempt Securities</p>	<p>due date, or the subject quarterly report on SEC Form 17-Q, or portion thereof, will be filed no later than the fifth calendar day following the prescribed due date; and</p> <p>3. The report/portion thereof is actually filed within the period specified by paragraph 1(A) hereof.</p> <p>iii. If paragraph (ii) above is applicable and the reason the subject report/portion thereof cannot be filed timely without unreasonable effort or expense relates to the inability of any person, other than the issuer, to furnish any required opinion, report or certification, SEC Form 17-L shall have attached as an exhibit a statement signed by such person stating the specific reasons why such person is unable to furnish the required opinion, report or certification on or before the date such report must be filed.</p> <p>iv. Notwithstanding paragraph (ii) above, a registration statement filed on SEC Form 12-1 pursuant to SRC Rule 8.1, the use of which is predicated on timely filed reports, shall not be declared effective until the subject report is actually filed pursuant to paragraph A hereof.</p> <p>v. If SEC Form 17-L filed pursuant to paragraph (ii) above relates only to a portion of a subject report, the issuer shall:</p> <p>1. File the balance of such report and indicate on the cover page thereof which disclosure items are omitted; and</p> <p>2. Include, on the upper right corner of the amendment to the report which includes the previously omitted information, the following statement: "The following items were the subject of SEC FORM 17-L and are included herein: (List Item Numbers)"</p> <p>A. Issuers of exempt commercial papers shall file the following</p> <p>i. Monthly reports (M-2-3-01) within ten (10) days after the end of the month;</p> <p>ii. Quarterly reports (Q-EPS for non-banks and Q-2-3-01 for banks) within fortyfive (45) days after the end of the quarter, respectively.</p> <p>B. Issuers shall furnish BSP copies of said reports.</p> <p>C. Underwriters or issuers of commercial papers shall file an annual information statement (SEC Form 85-18-1) on commercial paper transactions on or before January 30 of each year. A fee of Ten Thousand Pesos (P10,000.00) shall be paid in connection therewith.</p>	<p>(b) Include at the upper right corner of the amendment to the report which includes the previously omitted information the following statement: "The following items were the subject of SEC FORM 17- L and are included herein: (List Item Numbers)"</p> <p>A. Issuers of exempt commercial papers shall file the following reports:</p> <p>(i) Monthly reports (M-2-3-01) within ten (10) business days after the end of the month;</p> <p>(ii) Quarterly reports (Q-EPS for non-banks and Q-2-3-01 for banks) within forty-five (45) business days after the end of the quarter, respectively.</p> <p>B. Issuers shall furnish the BSP copies of the said reports.</p> <p>C. Underwriters or Issuers of commercial papers shall file an annual information statement (SEC Form 85-18-1) on commercial paper transactions on or before January 30 of each year. The corresponding fee shall be paid for such filing.</p>
----------------------------------------	------------------------------------------------------------------------------------------------------------------------------------------------------------------------------------------------------------------------------------------------------------------------------------------------------------------------------------------------------------------------------------------------------------------------------------------------------------------------------------------------------------------------------------------------------------------------------------------------------------------------------------------------------------------------------------------------------------------------------------------------------------------------------------------------------------------------------------------------------------------------------------------------------------------------------------------------------------------------------------------------------------------------------------------------------------------------------------------------------------------------------------------------------------------------------------------------------------------------------------------------------------------------------------------------------------------------------------------------------------------------------------------------------------------------------------------------------------------------------------------------------------------------------------------------------------------------------------------------------------------------------------------------------------------------------------------------------------------------------------------------------------------------------------------------------------------------------------------------------------------------------------------------------------------------------------------------------------------------------------------------------------------------------------------------------------------------------------------------------------------------------------------------------------------------------------------------------------------------------------------------------------------------------------------------------------------------------	-----------------------------------------------------------------------------------------------------------------------------------------------------------------------------------------------------------------------------------------------------------------------------------------------------------------------------------------------------------------------------------------------------------------------------------------------------------------------------------------------------------------------------------------------------------------------------------------------------------------------------------------------------------------------------------------------------------------------------------------------------------------------------------------------------------------------------------------------------------------------------------------------------------------------------------

Note: The signed version of the Amended Implementing Rules and Regulations (IRR) of the *Securities Regulation Code* (SRC) was published in February 2004. This version is available in the SEC website (<http://www.sec.gov.ph/irr/AmendedIRRfinalversion.pdf>). The draft version of the Revised Implementing Rules and Regulations (IRR) of the SRC (SRC Rule) was posted for public comments in February 2011. Public comments were closed on 15 March 2011. The draft version of the SRC Rule can be accessed through the SEC website, <http://www.sec.gov.ph/src/Draft2%20SRC%20IRR.2011.pdf>
Source: SEC.

G. Reporting Requirements for Cross-Border Deal

For purchase and sale of bonds issued offshore or onshore by residents regardless of denomination, reporting requirements are provided as follows:

Circular No. 32 dated 19 July 1994 requires all foreign loans, including bonds and notes, of residents—whether or not approved and/or registered with the BSP—to be regularly reported by the borrower to the BSP through the IOD, for statistical purposes until fully paid. This is in line with the BSP’s mandate to keep a comprehensive and updated record of the country’s external debt.

The transactions on or status of foreign loans are to be reported monthly to IOD using Form 2 (Monthly Report on Foreign Borrowings). A report shall be made as well on the disposition of bonds and/or notes proceeds under the Monthly Report on Disposition of Bonds and/or Notes Proceeds within 3 banking days from the end of each reference month until the bond and/or note proceeds are fully utilized, and the obligation is fully paid.

Under a BSP circular letter dated 23 April 2003, all AABs and offshore banking units (OBUs) shall report to the BSP, through the IOD, foreign portfolio investment transactions using prescribed report formats. Moreover, all foreign exchange transactions (e.g., trade, loans, investments, other current account and transfers) that pass through the banks are being reported under Foreign Exchange Form 1 (Consolidated Foreign Exchange Assets and Liabilities) every week within 5 banking days after the end of reference week.

H. Reporting Requirements for Foreign Currency-Denominated Instruments

Circular No. 32 dated 19 July 1994 requires all foreign loans (including bonds and/or notes) of residents—whether or not approved and/or registered with the BSP—to be regularly reported to the BSP through the IOD for statistical purposes until fully paid. This is in line with the BSP’s mandate to keep a comprehensive and updated record of the country’s external debt.

The transactions on or status of foreign loans are to be reported monthly to IOD using Form 2 (Monthly Report on Disposition of Bonds and/or Notes Proceeds) within 3 banking days from the end of each reference month until the bond and/or note proceeds are fully utilized, and the obligation is fully paid.

III. Trading of Bonds and Trading Market Infrastructure

This chapter focuses on trading in the Over-the-counter (OTC) market and Trading Market Infrastructure.

A. Trading

OTC transactions for trading bonds take place through two channels: 1) through the Bureau of the Treasury (BTr) for the primary market and 2) through the facilities of the Philippine Dealing and Exchange (PDEX).

BTr's OTC window sells government securities (GS) to specific investors who are participants of the primary market. PDEX facilities, through which the secondary market conducts OTC trading, are commonly referred to as the "organized" or "regulated" OTC market.

On 22 January 2008, the Securities and Exchange Commission (SEC) granted PDEX the authority to operate an OTC market and to function as a Self-Regulatory Organization (SRO) under the framework of the OTC Rules.⁴⁶

PDEX's electronic trading platform currently supports an OTC bilateral market where trading can occur through either a quote-driven or an order-driven system.

In March 2005, PDEX launched the Negotiated Dealing Trading Board for the inter-dealer market. It is a quote-driven system that allows dealers to electronically quote and request for quotes from one another. Once both counterparties agree on the details of the transaction, it automatically gets confirmed through the system.

To facilitate trading, inter-dealer brokers also operate in the secondary market, pre-arranging deals between counterparts, which are then entered into the PDEX trading system by the counterparties for incorporation into the price discovery, clearing and settlement, and SRO processes.

⁴⁶ Footnote 11.

In November 2006, PDEX launched the Auto-Matching Trading Board to complement the negotiated dealing system. It is an order-driven system that allows trading participants to enter bids and offers in a central order book that automatically matches these orders based on bilaterally set trading limits, price and time. It provides the basic structure for trading between public investors.

In February 2008, PDEX opened its trading platforms to the public market where broker participants can enter orders and transact on behalf of their clients. This was further expanded in June 2009 when PDEX launched its Fixed-Income Broker Internet Order System (FI-BIOS), which allowed broker participants to enter orders for their clients in the Auto-Matching Trading Board remotely via an Internet-accessible electronic interface. This expanded the reach of PDEX's trading platform even to municipalities and regions outside the capital, Manila.

In addition to being licensed as an operator and an SRO for the OTC market, PDEX is also licensed by the SEC as an exchange under the provisions of the Securities Regulation Code (SRC). In this capacity, PDEX provides a centralized infrastructure for trading, clearing and settlement of fixed-income securities, which ensures price discovery, transparency and investor protection.

In July 2006, SEC formally recognized PDEX as an SRO in the inter-dealer market and is thus vested with the responsibility of formulating the requisite market rules, undertaking surveillance, and enforcing compliance in the inter-dealer market.

In November 2007, the SEC expanded the SRO registration of PDEX to cover the inter-professional market, and in February 2008, its SRO authority was expanded to cover its members in all markets within the PDEX trading system, including the public market through their brokers, which entered the market at that time.

The exchange is currently developing a multilateral trading board, which will run on an order-driven system. However, bilaterally set trading limits will be replaced by a system that will automatically calculate the trading limits of a firm based on the amount of collateral it delivers.

Trading of listed debt securities is subject to the rules, conventions and guidelines of PDEX.

B. Bond Repurchase Market

Bond repurchase (or repo) refers to the sale of bonds with a commitment to repurchase them at some specific future date. In August 2008, the Philippine Dealing System (PDS) Group of Companies launched the PDEX Inter-Professional Repurchase Agreement Market Program to provide the necessary cash liquidity to dealers. Crucially, this also opened the way for other professional market participants such as trusts, mutual funds, pension funds, insurance companies, and other qualified institutional investors to become providers of cash to dealers. Currently, only government securities are allowed as subject of a repo transaction. Repurchased securities are transferred on the near leg to the account of the repo buyer (investor) and are held there during the tenor of the repo, after which it is returned to the repo seller, on the far leg.

Repo securities are subject to daily valuation during the tenure of the repo to maintain its value. Should there be a decline in the market value, the repo seller is required to deliver additional margin (cash or securities) to the repo buyer (investor, cash lender). However, should there be an increase in value; the repo buyer may release some portion of the repo securities equivalent to the excess in value.

PDEX provides the repo trading platform while the Philippine Depository and Trust Corporation (PDTC) provide third-party valuation management.

The SEC has approved the program rules for the PDEX Repo Program. The Bangko Sentral ng Pilipinas (BSP), the country's central bank, issued a letter signifying that it does not interpose any objection to the participation of its regulated entities in the program. The BSP also conducts repurchase agreements and reverse repurchase agreements with banks as part of its Open Market Operations (OMO) outside the PDEX Repo Program.

The repo market is still in its early stages of growth. At this time, there are 13 repo sellers and 27 repo buyers. Table 3.1 shows the total repo trading volume as of the end of 30 June 2011.

Table 3.1 Philippine Dealing Exchange Inter-Professional Repurchase Agreements (IP-Repo) Trading Volume (PHP billions)

Year	Volume
2008	9.65
2009	345.59
2010	255.87
As of 30 June 2011	53.53

Source: Philippine Dealing and Exchange Corporation.

C. Secondary Market Yields and Transparency in Bond Pricing

1. Trade Reporting Obligations under the Securities and Exchange Commission Over-the-Counter Rules⁴⁷

Under Section 16 of the SEC OTC Rules, brokers and dealers are required to “post or publish in its quotation system all transactions executed in said system within [a] minute from execution.” Brokers and dealers are required to report done trades on a security in a central trade-reporting system. These two requirements are automatically complied with for trades negotiated or executed using the PDEX trading platforms.

The OTC Rules provide flexibility for the existence of multiple trading platforms, in which case all such trades from various trading platforms should be reported to a central trade reporting system (CTRS). This manner of trading or reporting is yet to be utilized.

⁴⁷ Footnote 11

Under the SRC, among the requirements for the registration of an exchange is transparency of transactions on such exchange.⁴⁸ Moreover, SROs are required to ensure that their rules provide for the transparency of securities transactions and prices.⁴⁹

2. Data Dissemination

PDEX Trading participants may view on a real-time basis live bid and offer prices and/or yields and market-wide trade on debt securities listed and traded on PDEX through the trading system or through the PDEX MarketPage, a data publication facility. Access to the MarketPage is free of charge to PDEX trading participants. It is also available to non-trading participants on a paid subscription basis.

Real-time data is also viewable through the Reuters terminal and PDEX’s FI-BIOS, which is available through the Internet. Price and trade data are available on a delayed basis on the PDEX website.⁵⁰

Information on the terms and conditions of listed corporate debt securities, including the issue date, maturity date and coupon rate, may likewise be found in the respective prospectuses, offering circulars, or information memoranda posted on the PDEX website.

Trade data is also available through broadsheets, such as *BusinessWorld*.

D. Bond Settlement Infrastructure Diagram (PH:T+3)

Figure 3.1. shows the key elements of the bond market infrastructure in the Philippines.

Figure 3.1 Bond Settlement Infrastructure Diagram

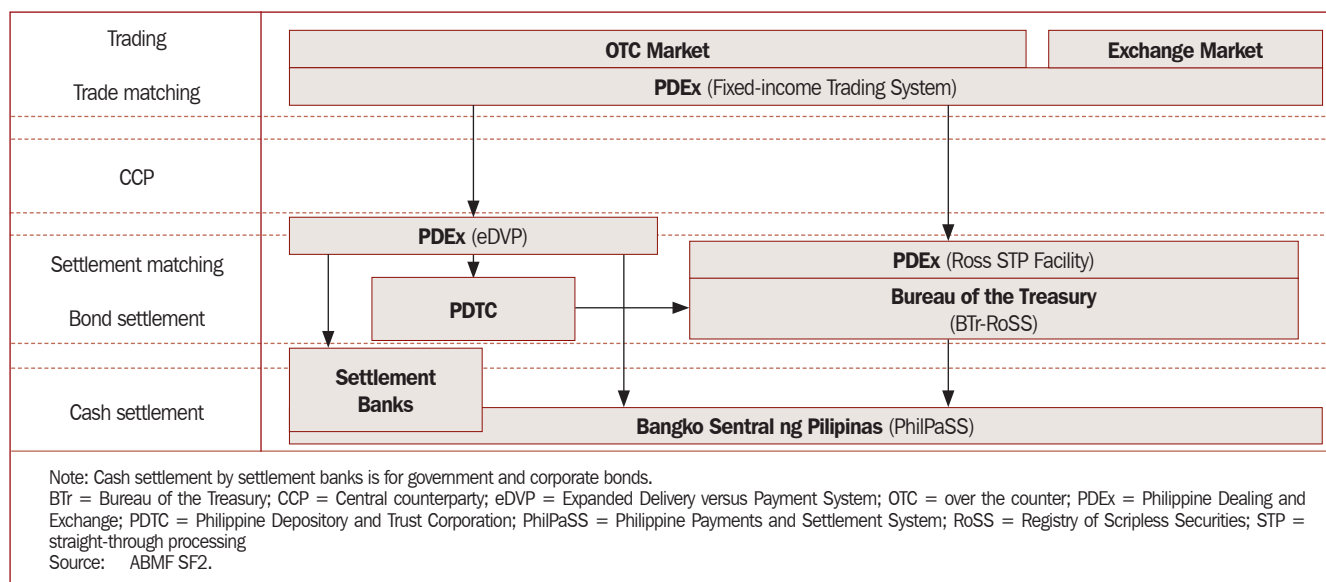

⁴⁸ Footnote 9, Section 33.2 (i).

⁴⁹ Footnote 24, Rule 40.4.

⁵⁰ Philippine Dealing and Exchange. <http://www.pdex.com.ph>

Cash settlement by settlement banks is for government and corporate bonds.

E. Bond Transaction Flow Charts

The flowcharts (Figures 3.2 and 3.3) in this section are intended to illustrate the transaction steps in the Philippine market, as seen between the buyer side and seller side of a bond transaction, and following through from the original trade negotiation to cash settlement and participant reporting. The flows illustrate typical transactions for Government Securities Eligible Dealers (GSED, Figure 3.2) and non-GSED market participants (Figure 3.3). For easy reference, the individual steps are explained after Figure 3.2 and before Figure 3.3, respectively.

a. Philippine Bond Market Government Securities Eligible Dealers and Delivery-versus-Payment System

Figure 3.2 Bond Transaction Flow for Domestic Trades Government Securities Eligible Dealers Market/ Delivery Versus Payment

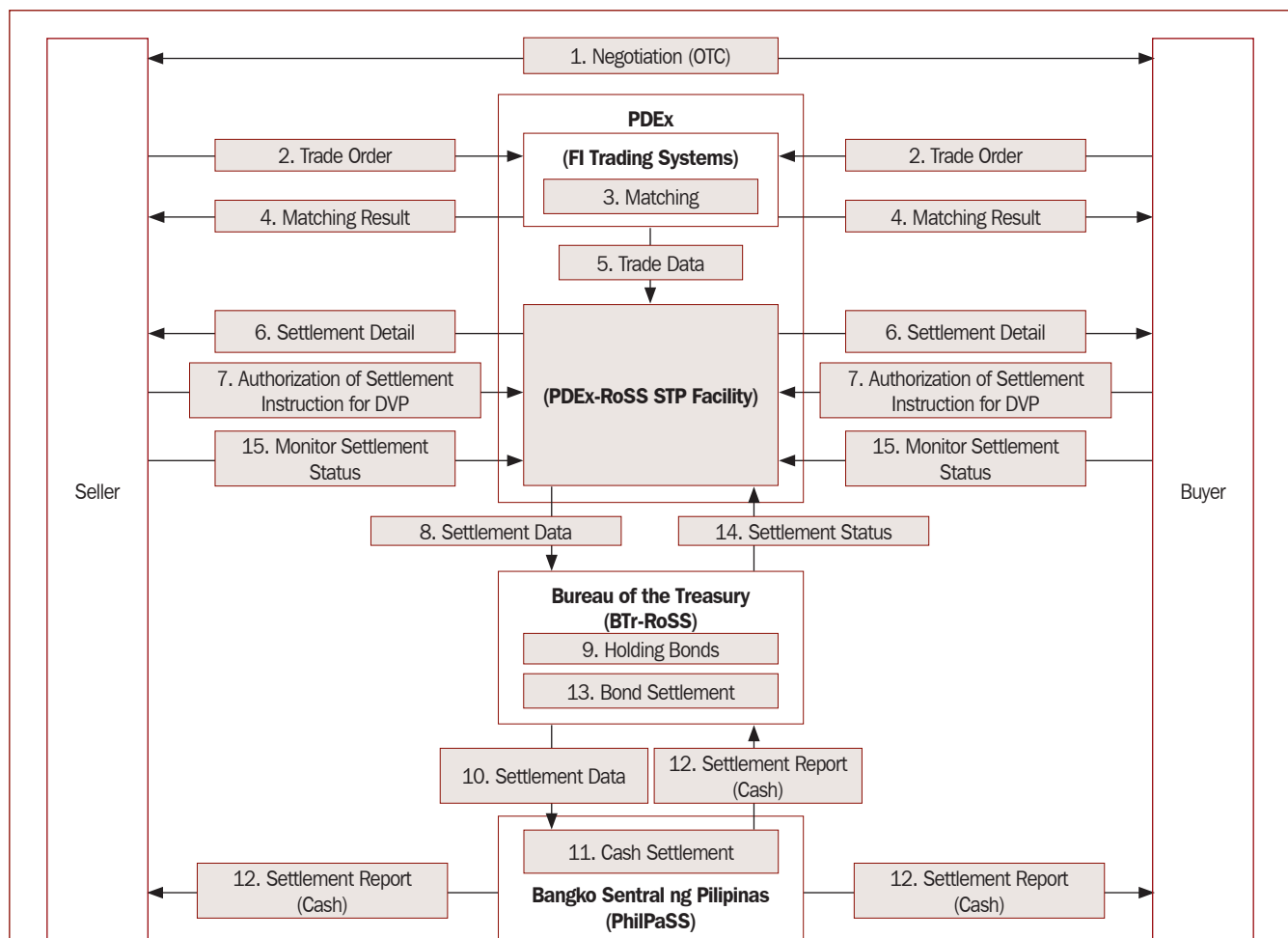

BTr = Bureau of the Treasury; DVP = Delivery versus Payment System; FI = fixed income; OTC = over the counter; PDEx = Philippine Dealing and Exchange; PDTC = Philippine Depository and Trust Corporation; PhilPaSS = Philippine Payments and Settlement System; RoSS = Registry of Scripless Securities; STP = straight-through processing
 Source: ABMF SF2.

The process in the exchange market for government securities eligible dealers (GSEDs) are as follows:

Exchange Market-Government Securities Eligible Dealers (GSEDs)

1. In the OTC market, the seller and buyer negotiate before they input the trade data to PDEX. This process is omitted in the Exchange Market.
2. The seller and buyer trade via PDEX (Fixed Income [FI] Trading System).
3. PDEX (FI Trading System) matches order or records negotiated deals between buyer and seller
4. PDEX (FI Trading System) sends matching result to the seller and buyer.
5. PDEX (FI Trading System) sends trade data to PDEX(PDEX-RoSS STP Facility).
6. PDEX (PDEX-RoSS STP Facility) sends settlement detail to the seller and buyer.
7. The seller and buyer authorize the settlement instruction for DVP.
8. PDEX (PDEX-RoSS STP Facility) sends settlement data to Bureau of the Treasury Registry of Scripless Securities (BTr-RoSS).
9. BTr-RoSS holds bonds before cash settlement.
10. BTr-RoSS sends settlement data to Bangko Sentral ng Pilipinas (BSP).
11. BSP executes cash settlement.
12. BSP sends cash settlement report to Seller, Buyer and BTr-RoSS.
13. BTr-RoSS executes bond settlement.
14. BTr-RoSS sends bond settlement status to PDEX-RoSS STP Facility
15. The seller and the buyer can monitor the settlement status via PDEX-RoSS STP Facility.

b. Philippine Bond Market Non-Government Securities Eligible Dealers and Delivery-versus-Payment System

The processes in the exchange market for non-GSEDs are as follows:

1. In OTC market, the seller and buyer negotiate before they input the trade data to PDEX. This process is omitted in the Exchange Market.
2. The seller and buyer trade via PDEX (FI Trading System).
3. PDEX (FI Trading System) automatically matches orders from seller and buyer.
4. PDEX (FI Trading System) sends matching results to the seller and buyer.
5. PDEX (FI Trading System) sends trade data to PDEX (eDVP System).
6. PDEX (eDVP System) sends settlement details to the seller and buyer.
7. The seller and buyer authorize the settlement instruction for DVP.
8. PDEX (eDVP System) sends earmarked instruction to PDTC.
9. PPDEX (eDVP System) sends cash settlement instruction to BSP.
10. PDTC and BTr-RoSS each hold bonds before cash settlement.
11. BSP executes cash settlement.
12. BSP sends cash settlement report to the seller, buyer, and PDEX (eDVP System).
13. PDEX (eDVP System) sends settlement instruction to Philippine Depository and Trust Corp (PDTC) and BTr-RoSS.
14. PDTC and BTr-RoSS executes bond settlement.
15. PDTC and BTr-RoSS sends settlement status to PDEX(eDVP System).
16. PDEX (eDVP System) sends bond settlement status to the seller and buyer.

Figure 3.3 Bond Transaction Flow for Domestic Trades Non-Government Securities Eligible Dealers Market/Delivery Versus Payment

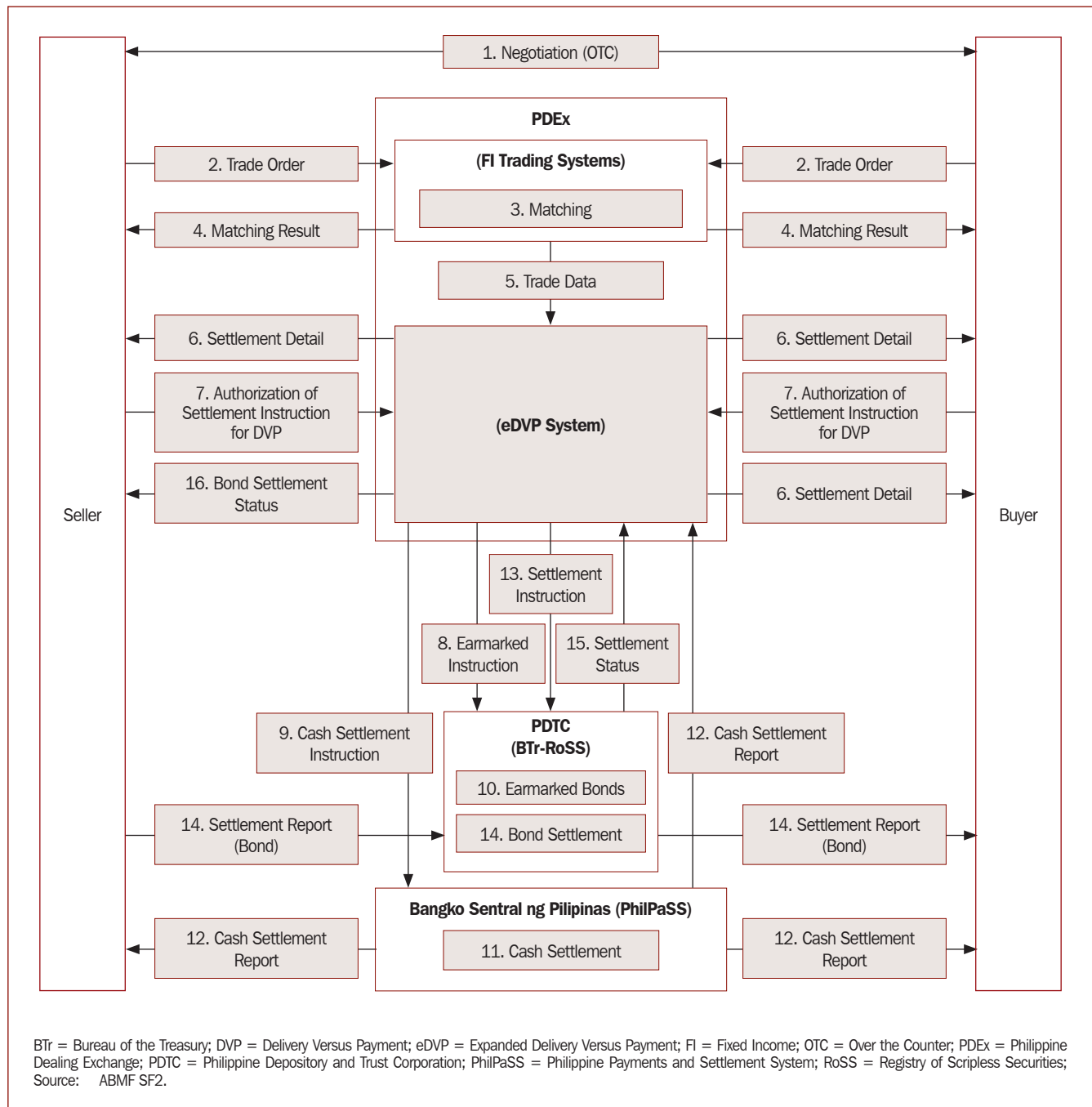

F. Over-the-Counter Bond Transaction Flow for Foreign Investors

The flowchart (Figure 3.4) includes cross-border, funding, and reporting components.

Figure 3.4 Bond Transaction Flow for Foreign Investors Over-the-Counter Market/Delivery Versus Payment

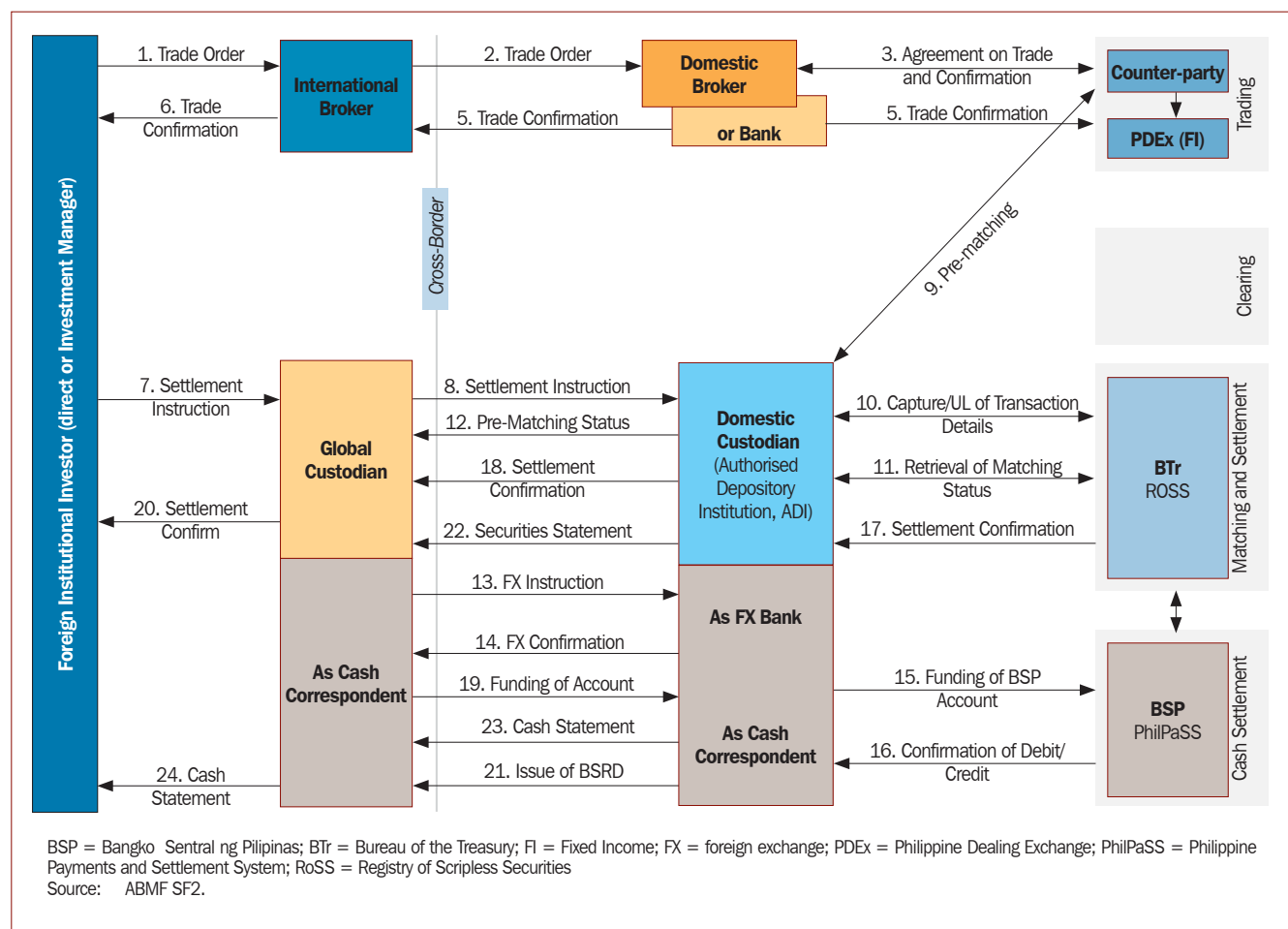

Trade Date

1. The Foreign Institutional Investor places the order with the International Broker.
2. The International Broker places the order with the Domestic Broker/GSED.
3. The Domestic Broker or Dealer trades OTC with a counterparty.
4. The Domestic Broker or Dealer captures trade in the PDEX system for price discovery within 10 minutes.
5. The International Broker receives trade confirmation.
6. The Foreign Institutional Investor receives trade confirmation.

Trade Date +1 (T+1)

7. The Foreign Institutional Investor instructs the Global Custodian on securities settlement and foreign exchange/cash funding details.
8. The Global Custodian instructs the Domestic Custodian on securities settlement details.
9. The Domestic Custodian conducts phone pre-matching with a counterparty or a custodian of the counterparty.

Settlement Date

10. The Domestic Custodian enters, the settlement data into the RoSS (typically via third Party front-end).
11. The Domestic Custodian retrieves the transaction matching status.
12. The Domestic Custodian reports the matching status update to the Global Custodian.
13. The Global Custodian sends foreign exchange instruction for projected funding requirements.
14. The Domestic Custodian sends foreign exchange confirmation.
15. The Domestic Custodian funds Bangko Sentral ng Pilipinas accounts via PhilPASS real-time gross settlement, if necessary.
16. Upon transfer of cash (after prompting from RoSS), PhilPaSS sends cash settlement confirmation to the Domestic Custodian.
17. Upon confirmation of cash settlement, RoSS effects bond settlement and sends confirmation to the Domestic Custodian.
18. The Domestic Custodian sends the settlement confirmation to the Global Custodian.
19. The Global Custodian funds the account with the Domestic Custodian in Philippine peso, or into foreign currency nostro (before end of day).
20. The Global Custodian sends settlement confirmation to the Foreign Institutional Investor.
21. The Domestic Custodian issues a Bangko Sentral Remittance Document (BSRD), certifying foreign currency inflow for ability to repatriate at later stage without consideration of foreign exchange limitations.
22. The Domestic Custodian sends the securities statement to the Global Custodian.
23. The Domestic Custodian sends debit/credit confirmations in the form of cash statement to the Global Custodian.
24. The Global Custodian sends the cash statement to the Foreign Institutional Investor.

IV. Possible Impediments and Restrictions

A. Taxation

1. Withholding Tax on Interest Income, Stamp Duty and Tax Report Requirement

A final tax at the rate of 20% is imposed on the amount of interest from any currency bank deposit and yield, or any other monetary benefit from deposit substitutes and from trust funds and similar arrangements.

Provided that, interest income received by an individual taxpayer (except a nonresident individual) from a depository bank under the expanded foreign currency deposit system shall be subject to a final income tax at the rate of seven and one-half percent (7 1/2%) [sic] of such interest income.⁵¹

Provided, further, that interest income from long-term deposit or investment in the form of savings, common or individual trust funds, deposit substitutes, investment management accounts and other investments evidenced by certificates in such form prescribed by the Bangko Sentral ng Pilipinas (BSP) shall be exempt from income tax. Provided, finally, that should the holder of the certificate pre-terminate the deposit or investment before the fifth (5th) [sic] year, a final tax shall be imposed on the entire income and shall be deducted and withheld by the depository bank from the proceeds of the long-term deposit or investment certificate based on the remaining maturity thereof:

*Four (4) years to less than five (5) years - 5%;
Three (3) years to less than (4) years - 12%; and
Less than three (3) years - 20%⁵²*

The final tax on interest is collected by the relevant depository bank or issuer of the long-term deposit or investment and remitted to the BIR.

⁵¹ Government of the Philippines. 1997. *National Internal Revenue Code of 1997*, sec. 24(B)(1), as amended.

⁵² Footnote 23.

B. Disclosure and Investor Protection Rules for Issuers

1. Registered Debt Securities

Under the Securities Regulation Code (SRC), issuers of registered debt securities are subject to initial disclosure and continuing reportorial requirements.

In the primary market, a minimum set of information on the issuer and the securities being offered is required to be included in the registration statement (RS) and the prospectus, which are subject to Securities and Exchange Commission (SEC) review before the RS is rendered effective and the Permit to Sell is issued by the SEC.

The prospectus shall be widely disseminated—defined as having been distributed initially and additional copies have been furnished promptly—upon request to the participants in the distribution, the SEC, the exchange (if the securities will be listed), and 20 or more persons who are not qualified buyers under sec. 10.1(L) of the SRC.

Under the SRC, a reporting company, which is defined as a corporation that has sold a class of its securities pursuant to a registration under sec. 12 of the SRC, is required to submit an annual report using SEC Form 17-A, quarterly reports on SEC Form 17-Q, and current reports on SEC Form 17-C.

Current reports shall be filed to make a full, fair and accurate disclosure to the public of every material fact or event that occurs, which would affect investors' decisions in relation to those securities. The disclosure contained in a current report shall be made: (a) promptly to the public through the news media; (b) if the issuer is listed on an exchange, to that exchange within 10 minutes after occurrence of the event and prior to its release to the public through the news media, with a copy furnished to the SEC; and (c) to the SEC on SEC Form 17-C within 5 days after occurrence of the event being reported, unless substantially similar information has been previously reported to the SEC by the issuer.

Issuers of debt securities listed on the Philippine Dealing Exchange (PDEX) are subject to continuing disclosure obligations. Disclosures received from listed issuers are published on the PDEX website.⁵³

2. Exempt Securities and Exempt Transactions

Debt securities that qualify as exempt securities or issued under exempt transactions, particularly under SRC Rule 10.1 (K) and (L), are not subject to initial and continuing disclosure requirements under the SRC. Hence, investors of such securities are responsible for obtaining information on the issuer and the offered securities to assist them in the performance of their due diligence.

Under current regulations, issuers of exempt transactions to 19 non-qualified investors (SRC Rule 10.1[K]) or to qualified buyers (SRC Rule 10.1[L]) are required to file a notice of exemption with the SEC.

⁵³ Philippine Dealing and Exchange Corporation. <http://www.pdex.com.ph>

3. Information on Intermediaries and Market Participants

A list of registered market participants, including brokers or dealers, underwriters, issuers and registered fixed-income market salesmen is posted on the SEC website.⁵⁴ Other information, such as financial information, on registered market participants is not available in the SEC website.

C. Underwriting Rules for Financial Institutions

Universal banks, by virtue of their expanded functions, can undertake underwriting functions, and are under the dual regulation of the BSP and SEC.

The SRC Implementing Rules and Regulations (IRR) requires registered debt securities to be covered by a firm commitment underwriting agreement with a universal bank, investment house, or other financial institutions duly licensed under the *Investment Houses Law*.

D. Impediments for Timely Issuance (Suspension Period, Disclosure Requirements, and Others)

The RS is subject to SEC review. The SEC may require additional information or disclosures or require clarifications from the issuer, prior to rendering the registration statement effective. Registration is also subject to filing fees payable to the SEC. Due to the process, both initial and continuing requirements, costs related to registration, and the ease and availability of bank loans and other bilateral financing facilities, corporate issuers have shown a preference for bank financing or issuances through exempt securities or transactions.

Current securities regulations for shelf registration are limited.

Registered but unsold securities shall be offered within 1 year from registration, and an updated RS shall be filed with the SEC prior to offering or sale. The registration shall cover either short-term or long-term debt securities, not a combination of different tenors. This limits the flexibility of the issuer to tap the capital markets for its funding requirements when market conditions are favorable.

E. Restriction on Investors (Qualified Institutional Investors and Private Placement)

Under SEC over-the-counter (OTC) Rules, non-qualified investors shall participate in a registered OTC market only through the following means:

- (a) The service of another person such as broker, investment house or bank, each in its own capacity as an authorized broker in an OTC market, or
- (b) Participation in a registered or chartered collective investment scheme such as an investment company, non-directional trust fund, or pension fund.

⁵⁴ Securities and Exchange Commission. <http://www.sec.gov.ph>

Under SRC Rule 9.2(2)(B), evidences of indebtedness issued to primary institutional lenders are exempt from registration requirements, provided all such evidence of indebtedness shall only be negotiated or assigned to primary institutional lenders. In no case shall such instruments be negotiated or assigned to non-qualified investors.

Under SRC sec. 10.1(L) and SRC Rule 10.1, securities distributed only to qualified buyers defined under securities regulations may be classified as an exempt transaction. If the initial qualified buyer/s shall resell their securities to more than 19 non-qualified buyers or investors, the securities will then be subject to registration.

F. Registration Requirements for Foreign Investors

Registration of foreign investments with the BSP is at the option of the foreign investor or his authorized representative. Such registration would entitle the investor, or his representative, to purchase foreign exchange from authorized agent banks (AABs), AAB-subsidiary or affiliate foreign exchange corporations (AAB-forex corps) for capital repatriation in foreign exchange of the peso liquidation or sales proceeds and/or outward remittance of dividends, profits and/or earnings accruing on Bangko Sentral ng Pilipinas (BSP)-registered investments.

For unregistered foreign investments, such peso liquidation or sales proceeds, as well as related profits, may only be converted to foreign exchange with enterprises other than AABs or AAB-forex corps.

G. Reporting Requirements (Non-Resident Trade Report, Foreign Currency-Denominated Instruments and Others)

Circular No. 32 dated 19 July 1994 requires all foreign loans, including bonds and/or notes, of residents (whether or not approved and/or registered with the BSP) to be regularly reported to the BSP, through the International Operations Department (IOD), for statistical purposes until fully paid. This is in line with the BSP's mandate to keep a comprehensive and updated record of the country's external debt.

The transactions on and status of the foreign loans are to be reported monthly to IOD under Form 2 (Monthly Report on Foreign Borrowings), and the disposition of bonds/notes proceeds under the Monthly Report on Disposition of Bonds/Notes Proceeds within 3 banking days from the end of each reference month until the bond or note proceeds are fully utilized, and the obligation is fully paid.

Moreover, all foreign exchange transactions (e.g., trade loans, investments, other current account and transfers) that pass through AABs or offshore banking units are being reported under Foreign Exchange Form 1 (Consolidated Foreign Exchange Assets and Liabilities) every week within 5 banking days after the end of the reference week.

H. Non-Resident Requirements (Identification Requirement, Restricted Stocks and Others)

For purposes of opening an account with a broker, non-resident investors are required to disclose their true and full identity by accomplishing a Customer Account Information Form or its equivalent, specimen signature cards, and submit valid identification cards in accordance with the know-your-customer or Customer Identification Program of the broker in compliance with the requirements of the SRC and the *Anti-Money Laundering Act*, as amended.

I. Restrictions on Over-the-Counter Transactions by Residents and Non-Residents

Non-qualified investors, i.e., under the OTC Rules⁵⁵, that do not fall under the classification of qualified investors, and qualified investors that do not want to participate in the OTC market as qualified investors, cannot participate in an OTC market unless such participation is through an intermediary such as a broker, an investment house or bank in its capacity as a broker; or through participation in a mutual fund, pension fund, or non-directional trust fund.

J. Regulations on the Credit Rating System

1. Securities Regulation Code Requirements for Credit Rating of Registered Debt Securities

Except for issuances amounting to not more than 25% of the issuer's net worth, or where there is an irrevocable committed credit line with a bank covering 100% of the proposed issuance, registered debt securities shall be rated by a rating agency duly accredited by the SEC.

To ensure that a rating is accurate and issued with best objectivity, the credit rating agency (CRA) shall monitor three things on a continuing basis: (i) each issuer, (ii) if an issuer rating was given, and (iii) each issue.

The SRC also enumerates the rating criteria that shall be considered by the CRA.

2. Bangko Sentral ng Pilipinas Requirements for Credit Rating

Section X119.4, or the "Public Issuance of Unsecured Subordinated Debt," of the *Manual of Regulations for Banks* (MORB) issued by the BSP provides that issuance by a bank of unsecured subordinated debt requires the issuing bank to be rated by an independent CRA recognized by the BSP. On the other hand, governing regulations for issuances of long-term negotiable certificates of time deposits do not specify a credit rating requirement.

K. Utilization of Shelf-Registration System or Medium-Term Notes

Current securities regulations for shelf registration are limited.

Registered but unsold securities shall be offered within 1 year from registration, and

⁵⁵ Footnote 11.

an updated RS shall be filed with the SEC prior to offering or sale. The registration shall cover either short-term or long-term debt securities, not a combination of different tenors.

This limits the flexibility of the issuer to tap the capital markets for its funding requirements when market conditions are favorable.

The filing fee is currently based on the total amount of debt securities proposed to be issued, subject to a diminishing fee in inverse proportion in accordance with the SEC's fee schedule, and is payable upon filing of the RS, and not on a pay-per-avaiement basis.

L. Availability of Information in English

All information pertaining to the Philippine bond market are readily available in English.

M. Restrictions in Accounting Standard

International Accounting Standards (IAS) 39 on Financial Instruments is part of the rules on financial reporting of corporations. This standard requires classification of financial instruments according to the intention over the investment. For bonds that are classified under "held to maturity," sale or de-recognition of the bonds prior to maturity is prohibited under the "tainting rule" of IAS 39.

N. Limited Opportunities to Utilize Bond Holdings and the Repo Market

The Philippine Dealing Systems (PDS) Inter-Professional Repurchase Agreement Program is open to all government securities. The PDS Securities Lending Transactions Program is currently limited to government securities that comply with specified liquidity criteria.

O. Degree of Lack of Liquidity in the Secondary Market

1. Transfers Across Tax Categories

The current market framework limits the issuance, trading, and settlement of fixed-income securities as follows:

- (i) For regular government securities, separate instruments for a single tenor are issued for tax-withheld and tax-exempt investors, and transfers are allowed only among holders of the same tax category.
- (ii) For corporate fixed-income securities, only one instrument is issued for all investors; however, transfers across two types of tax categories—tax-withheld and tax-exempt—are restricted to coupon dates, or treats as tax-withheld a tax-exempt holder trading across tax categories.

Thus, under the present structure, trading prior to coupon date transpires mostly between holders of the same tax category, thereby limiting the access to liquidity of all the holders.

2. Liquidity of Corporate Fixed-Income Securities

Corporate fixed-income securities listed and traded on PDEX have lower trading volumes and lower turnover ratios compared to government securities traded on the PDEX market. Factors that may contribute to this are the relatively smaller average issue size of corporate issuances, skewed distribution toward qualified institutional investors that tend to be buy-and-hold investors, limited market-making activities, and the lack of alternative investment outlets for investors.

Listed corporate fixed-income securities benefit from having a central venue for investors to sell or buy such securities.

P. Trade Pre-Matched via Telephone between Custodians for Foreign Institutional Investor

All trades for Foreign Institutional Investor clients are being pre-matched via telephone between custodians.

V. Description of the Securities Settlement System

A. Legal Definition of Debt Instruments

1. Existence of Uniform Legal Framework for Types of Securities

Certain disparities exist between and among legal frameworks that apply to different types of securities. Most principal of these differences arise from the fact that equity securities and their trading market are under the regulation of the SEC alone. On the other hand, debt securities, where the trading community are composed mainly of banks, even in instances where debt securities are issued by a bank, become subjected to a more complex regulatory regime which would involve the banking regulator.

2. Dematerialization and Immobilization versus Physical Securities

Both equities and debt securities are legally recognized in physical and dematerialized form. In the organized market for debt securities, however, debt securities must be in dematerialized form and cannot be listed if the same are still in physical form, even if immobilized.

In the equities market, the law recognizes the right of equities investors to require a physical certificate as evidence of their investments.

While the infrastructure provides for the immobilization of the physical security, the investor may “uplift” the security from the depository and place the same in physical form, as a right recognized by law.

3. Legal Ownership Transfer Mechanism

Securities in the organized market are transferred in book-entry form.

B. Securities Settlement Infrastructure

1. Existence of Central Securities Depository and Book-Entry System for Debt Instruments

In Philippines there are two Foreign Institutional Investor (CSD); (1) Philippine Depository and Trust Corporation (PDTC), CSD for equities and fixed-income securities; and (2) Bureau of the Treasury (BTr), CSD for government securities (Treasury bills and government bonds).

The PDTC provides depository and settlement services for equities and commercial papers and private bonds. It is a member of the PDS Group of companies, composed of the Philippine Dealing System (PDS), the holding company of the Group, and its three operating subsidiaries: the Philippine Dealing and Exchange (PDEX), PDTC, and the Philippines Securities Settlement Corporation (PSSC).

PDTC, formerly known as the Philippine Central Depository (PCD), is a securities depository operating in Philippines. It has been in operation since 1995 and is the sole owner of a special purpose corporation, PCD Nominee, specifically set up to hold legal title to securities lodged in the depository as nominee.

PDTC services fixed-income and equity market segments in the Philippine markets and has real-time interface with settlement banks, including the central bank, to settle fixed-income spot and repo trades, inter-bank foreign exchange transactions and cash entitlements such as cash dividends and coupon/maturity payments.

Its depository service operates a book-entry system for the transfer of ownership of debt instruments.

2. Existence of Delivery-versus-Payment and Real Time Gross Settlement Mechanism

The existing Real Time Gross Settlement (RTGS) system for the government securities market was put in place in 2002. The delivery-versus-payment (DVP) system was already in place even before the commencement of PDEX's organized market for the inter-dealer sector, to enable the inter-dealer market to settle on a DVP basis. In 2006, the PDEX market was connected to this system, and a straight-through processing (STP) facility was operationalized so that trades executed on the PDEX market were fed to the settlement system without further manual intervention to enter settlement details.

a. Registry of Scripless Securities-Delivery-versus-Payment System for Inter-Dealer Government Securities Trades

The Registry of Scripless Securities (RoSS) system checks the securities in the seller's securities account and earmark these for transfer. The system then sends an electronic settlement file to BSP containing the amount to be debited and credited to the Regular Demand Deposit Account (RDDA) of the buyer and seller. Once settlement is processed, the BSP Philippine Payment and Settlement System (PhilPaSS) will send back a file message that settlement was done. The RoSS system will then transfer the earmarked securities from the seller's securities account to the buyer's securities account.

b. The Expanded Delivery-versus-Payment System for the Organized Market

In 2007, the settlement system was expanded to cover investor markets, beginning with the inter-professional market in 2007, and the retail market in 2008.

With the expanded delivery-versus-payment (eDVP) system supplementing the RoSS DVP, all trades in PDEX are settled on a DVP basis, with STP.

3. Existence of Post-Trade Matching System

There is no need for post-trade matching system in the organized debt securities market. All trades that are executed on the trading system are fed to the settlement system via STP for final settlement.

On the other hand, all trades for Foreign Institutional Investor (FII) clients are being pre-matched via telephone between custodians.

4. Bond and Other Debt Securities

All trade settlements occurring through the PDEX organized market are done on a gross, trade-for-trade basis.

5. Settlement Cycle for Corporate Bond, Government Bond, and Other Debt Securities

See Figure 5.1 and 5.2.

Figure 5.1 Settlement Process for Government Bond Trades Where Both Parties Are Government Securities Eligible Dealers

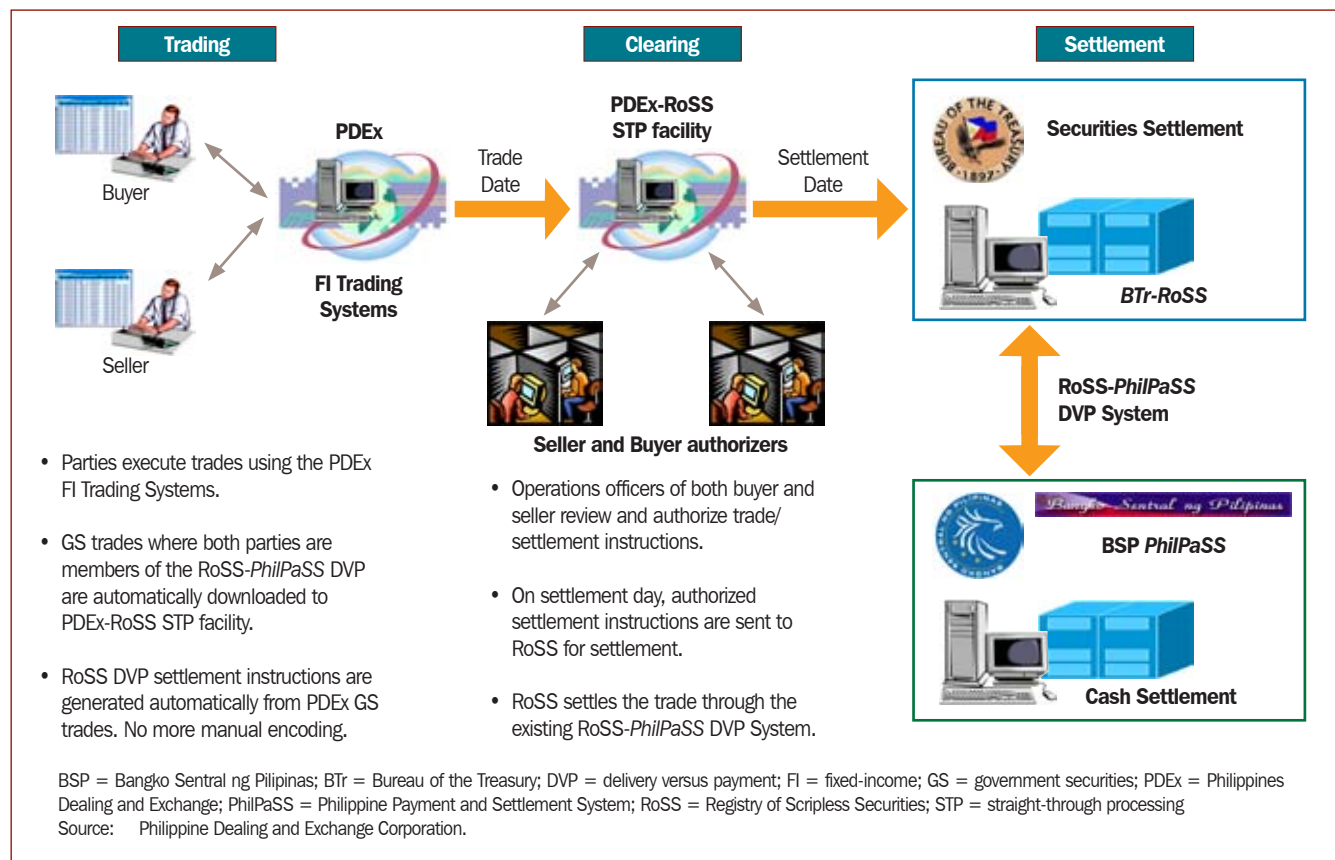
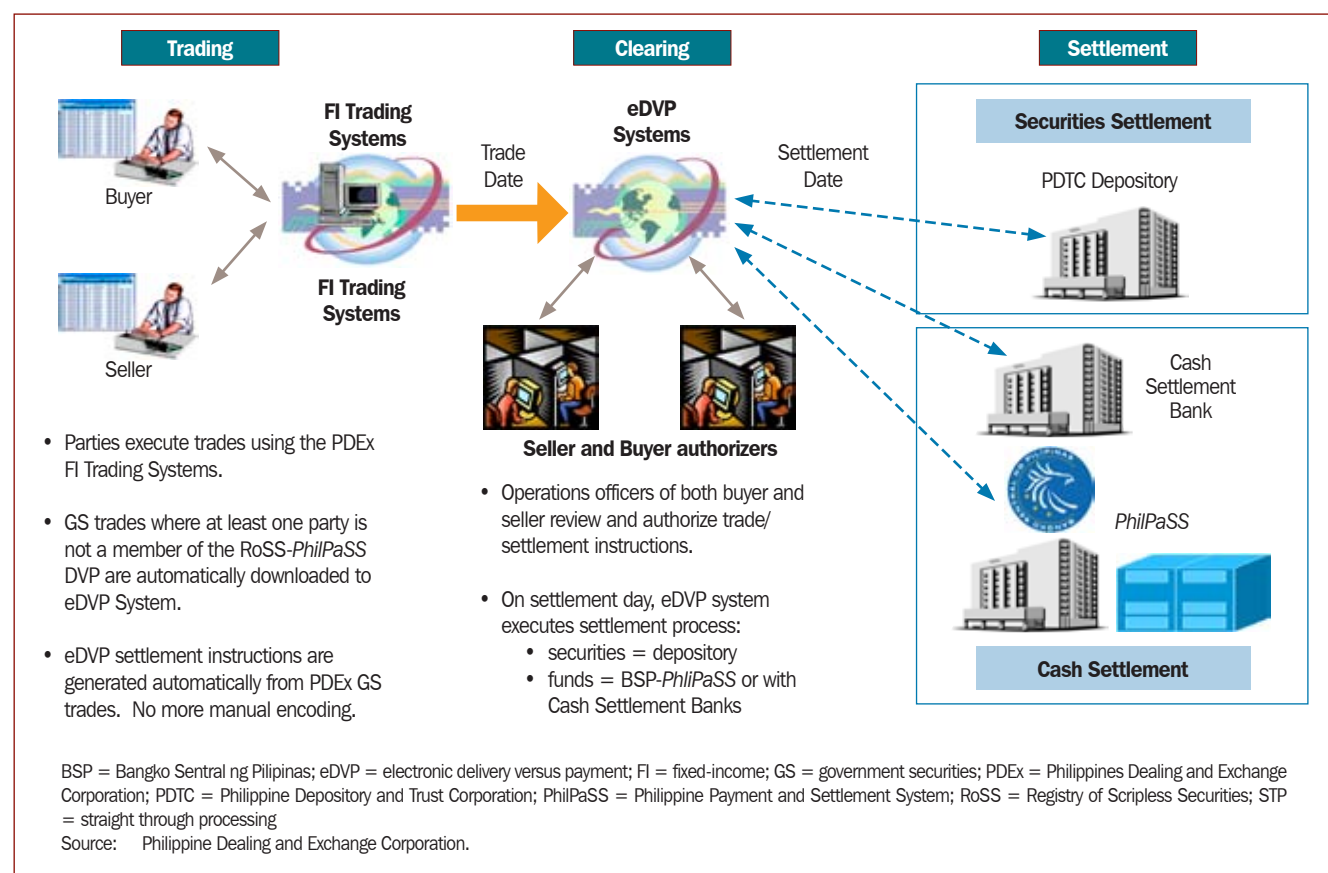

Figure 5.2 Settlement Process for All Corporate Bond Trades and Government Bond Trades Where One or Both Parties Are Not Government Securities Eligible Dealers



6. Brief History of the Development of the Securities Settlement Infrastructure

The depository, PDTC, formerly known as Philippine Central Depository (PCD), has been operational since 1995, providing depository services to the equities market. Its increasing role in the fixed-income market has grown in recent years as the organized market evolved. When the organized market began in March 2005, with the inter-dealer market trading government securities, the securities settlement infrastructure did not, as yet, include the depository. Trades were settled at the level of the RoSS operated by the BTr. This configuration was already capable of performing DVP settlement for inter-dealer trades.

The PDEX market opened up to the inter-professional segment in 2007, allowing as well the enrolment of corporate securities.

The DVP infrastructure was augmented to bring the depository within the purview of the DVP process, so that members of the trading community outside the banking sector could enjoy settlement on a DVP basis, and allowing DVP for corporate securities. This infrastructure likewise hosts settlement of trades of the public market, which entered the trading community through their brokers in early 2008. Listed corporate securities intended for distribution to the public are now also a part of this market. The settlement process and infrastructure allow investors to settle their trades directly into their own accounts, should they desire to do so.

VI. Cost and Charging Methods

A. Average Issuing Costs for Corporate Bonds and Commercial Papers

1. SEC Registration Fees for Registration Statement of Debt Securities and Commercial Papers

a. Registration Statement Filing Fee

Registration Statement filing fees are subject to the following fee schedule.

Table 6.1 Registration Statement Filing Fee

Face Value of the Security	Calculation of the Fees
Not more than PHP500 million worth of securities	0.10% of maximum aggregate price of securities to be offered
More than PHP500 million, not more than PHP750 million	PHP500,000 + 0.075% of excess over PHP500 million
More than PHP750 million, not more than PHP1 billion	PHP687,500 + 0.05% of excess over PHP750 million
More than PHP1 billion	PHP812,5000 + 0.025% of excess over PHP1 billion

Source: Securities and Exchange Commission: "Consolidated schedule of fees and charges. Survey about all the fees and charges to be imposed was executed in 2004 by SEC. Result report "Consolidated schedule of fees and charges" is available from the following website: <http://www.sec.gov.ph/circulars/cy,2004/sec-memo-9,s2004.pdf>

b. Legal Research Fee

The issuer is charged a legal research fee equivalent to 1% of the filing fee, but not less than PHP10.

2. Documentary Stamp Taxes

Documentary stamp taxes equivalent to PHP1 for every PHP200 of the face amount of the debt securities is payable upon issuance, and is generally for account of the issuer.

3. Publication Costs

A survey on publication fee collected from the industry shows that publication fees for registered bonds costs PHP50,000 per publication.

4. Other Fees

a. Underwriting or Selling Agency Fees

Underwriting or selling agency fees are subject to negotiation between the issuer and the underwriters or selling agents, as documented in the transaction agreement between the parties.

Fees to underwriters of registered debt securities are generally disclosed in the prospectus. A survey on underwriting and selling agent fee collecting from the industry shows the following range:

Table 6.2 Fees to Underwriters or Selling Agent

Corporate Notes		Registered Bonds	
Low	High	Low	High
0.25%	1.50%	0.45%	1.50%
		0.35% ^a	0.60% ^a

^a Based on prospectuses of listed registered corporate bonds
Source: Securities and Exchange Commission.

b. Trustee Fees

Trustee fees are subject to negotiation between the issuer and the trustee, as documented in the trustee agreement between the parties. Trustee fees for registered debt securities are generally disclosed in the prospectus. A survey on trustee fee collecting from the industry shows the following range:

Table 6.3 Trustee Fees

Corporate Notes		Registered Bonds	
Low	High	Low	High
As a percentage of MPC ^a	As a percentage of MPC ^a	PHP300,000	PHP600,000
		PHP95,000 ^b	PHP270,000 ^b

^a MPC pertains to Mortgage Participation Certificates issued by the trustee to the lenders. This usually happens if the loan or notes are secured by a pool of assets.
^b Upfront and first year trustee fees are based on prospectuses of listed registered corporate bonds.
Source: Securities and Exchange Commission.

c. Credit Rating Fees

Fees payable to the credit rating agency (CRA) is subject to negotiation between the issuer and the rating agency. Ratings fees for registered debt securities are generally disclosed in the prospectus.

d. Listing Fees

Securities listed on Philippine Dealing Exchange (PDEX) are subject to a one-time application fee. Listing fees for registered debt securities are generally disclosed in the prospectus.

e. Miscellaneous Fees

Other fees reported by the industry are shown in Table 6.4.

Table 6.4 Other Fees

Type of Fee	Corporate Notes		Registered Bonds	
	Low	High	Low	High
Legal Fee	PHP500,000	PHP1 million	PHP1.5 million	PHP2.5 million
Facility Agency Fee (Registry and Paying Agency):				
Bundled pricing	PHP300,000 (based on past transactions, subject to negotiation)	PHP600,000 (based on past transactions, subject to negotiation)	Not applicable	Not applicable
Registry Fee (excluding Paying Agency)	0.0025% p.a. with PHP180,000 minimum	0.03% p.a.	0.0025% p.a. with PHP180,000 minimum	0.03% p.a.
Paying Agency Fee (excluding Registry Fee)	Pricing Model 1: 5 bps of amount to be paid with minimum of PHP10,000 and maximum of PHP100,000 per payment date		Pricing Model 2: Flat rate per holder of either PHP50 (via check) or PHP540 (RTGS)	
Account Opening Fee (per holder)				
	Low		High	
Primary Issuance	PHP75 (minimum of PHP20,000)		PHP75	
Secondary Trading	PHP75		PHP100	
p.a. = per annum; bps = basis points; RTGS = real time gross settlement Source: Securities and Exchange Commission.				

B. Average Ongoing Costs for Corporate Bonds and Commercial Papers

1. Credit Rating Agency Annual Monitoring Fee

The CRA annual monitoring fee is subject to agreement between issuer and rating agency. For registered debt securities, the fee is generally disclosed in the prospectus.

2. Trustee Annual Retainer Fee

The trustee annual retainer fee is subject to agreement between the issuer and trustee. For registered debt securities, this is generally disclosed in the prospectus.

3. Registry Maintenance and Paying Agency Fees

These fees are subject to agreement between the issuer, the appointed registry, and the paying agent. For some debt issuances, the annual maintenance fee is on the account of the holders and is deducted from the coupon entitlement. For registered debt securities, fees are generally disclosed in the prospectus.

4. Listing Maintenance Fee

Securities listed on PDEX are subject to annual maintenance fees. Listing maintenance fees for registered debt securities are generally disclosed in the prospectus.

5. Fees related to Secondary Transfers

Fees related to secondary market transactions are generally for account of the transacting trading participants/investors.

a. Broker's Commissions

The broker's commission is subject to the commission schedule of the executing broker. Rules and regulations of Securities and Exchange Commission and PDEX currently do not prescribe a minimum or maximum broker-commission rates. A survey on Broker's Commissions collected from the industry shows the following range:

Table 6.5 Broker's Commissions

Corporate Notes		Registered Bonds	
Low	High	Low	High
0	0.25%	0.10%	0.50%
Source: Securities and Exchange Commission.			

b. Trade Matching Fees

PDEX charges an ad valorem trade matching fee of 0.25 basis points (bp) based on the face amount for all trade transactions executed in the PDEX market, on account of both the selling and buying trading participants.

c. Depository Fees

The depository does not charge a fee for lodging (i.e., depositing) securities into a depository securities account for purposes of settlement of trade transactions. An uplift fee is charged for the withdrawal of lodged securities in the depository with minimum of PHP10 and maximum of PHP100 per transfer. Debt securities kept in a depository account are subject to a depository maintenance fee based on the face value of the securities at a rate of 0.5 basis points per annum.

d. Private Registry Transfer Fees Not Applicable to Government Securities Registry

The appointed registry charges transfer fees, including transfers to and from the registry and the depository for purposes of settlement of trade transactions. A survey on transfer fees collected from the industry shows the following range:

Table 6.6 Private Registry Transfer Fees

Transfer Fee - Trade Transactions	
Low	High
PHP80 per side (buy/sell)	PHP200 transfer fee (for the account of the transferor noteholders)
Source: Securities and Exchange Commission.	

VII. Market Size and Statistics

A. Market Size

Table 7.1 Capital Market (Direct Financing) versus Bank Loans (Indirect Financing) (PHP billion)

Year	Bank Loans	Bonds	Total
2005	1,872.74	2,187.45	4,060.19
2006	2,073.35	2,236.20	4,309.55
2007	2,194.78	2,322.44	4,517.22
2008	2,502.33	2,609.57	5,111.90
2009	2,724.87	2,812.48	5,537.35
2010	2,802.29	3,199.27	6,001.56

Source: Asian Development Bank, AsiaBondsOnline; Bangko Sentral ng Pilipinas; Bureau of the Treasury.

Table 7.2 Fixed-Income Instruments per Issuer Type and Outstanding Amount (PHP billion)

Year	Government Securities	Corporate Bonds	Total
2005	2,134.36	53.09	2,187.45
2006	2,131.28	104.92	2,236.20
2007	2,178.37	144.07	2,322.44
2008	2,398.14	211.43	2,609.57
2009	2,460.90	351.58	2,812.48
2010	2,708.96	490.31	3,199.27

Source: Asian Development Bank, AsiaBondsOnline, Bureau of the Treasury.

Table 7.3 Bonds and Corporate Papers Issued by Corporations Registered under the Securities and Exchange Commission

Name of Corporation	2008	2009	2010	2011
Abotiz Power Corporation		Fixed-rate Bonds with an aggregate amount of up to PHP3 billion inclusive of PHP1.5 billion worth of bonds to cover an over-subscription at an issue price of 100% of face value - Order No. 048 dated 7 April 2007		
Ayala Corporation			PHP10 billion Fixed-rate Putable Bonds - Order No. 125 dated 19 April 2010	PHP10 billion Fixed-rate Multiple Put Bonds - Order dated 2 May 2011
Ayala Land, Inc.	PHP4 billion worth of Fixed-rate Bonds - Order No. 079 dated 4 August 2008	PHP504 million worth of Homestarter Bonds - Order No. 140 dated 25 September 2009	PHP504 million with an oversubscription of PHP504 million worth of Homestarter Bonds - Order No. 114 dated 9 March 2010	PHP2.07 billion worth of Homestarter Bonds - Order dated 8 April 2011
City and Land Developers, Inc.	PHP200 million worth of short-term commercial papers - Order No. 091 dated 28 August 2008	PHP200 Million worth of short-term commercial papers - Order No. 133 dated 2 September 2009		
Cityland Development Corporation	PHP900 million worth of short-term commercial papers - Order No. 147 dated 8 December 2008	PHP900 million worth of STCPs - Order No. 187 dated 7 December 2009	PHP1 billion worth of short-term commercial papers - Order No. 294 dated 2 December 2010	
Cityland, Inc.	PHP1.15 billion worth of short-term commercial papers - Order No. 129 dated 3 November 2008	PHP900 million worth of STCPs - Order No. 167 dated 9 November 2009		
Energy Development Corporation		PHP10 billion Fixed-rate Bonds, Order No. 170 dated 16 November 2009		
Filiinvest Land, Inc.		PHP5 billion worth of Fixed-rate Bonds - Order No. 157 dated 6 November 2009		PHP3 billion Fixed-rate Bonds - Order dated 24 June 2011
Globe Telecom, Inc.		PHP10 billion Fixed-rate Bonds, PHP5 billion of which is shelf registration - Order No. 019 dated 10 February 2009		
JGSummit Holdings, Inc.		PHP5 billion Fixed-rate Bonds, Order No. 165 dated 5 November 2009		
Manila Water Company, Inc.	PHP4 billion worth of Fixed-rate Bonds - Order No. 116 dated 10 October 2008			
Megaworld Corporation		PHP5 billion worth of Fixed-rate Bonds due 5-18-2015 - Order No. 156 dated 5 November 2009		
PCI Leasing and Finance, Inc. (Now BDO Leasing and Finance, Inc.)	PHP4 billion worth of short-term commercial papers - Order No. 153 dated 12 December 2008	PHP8 billion worth of short-term commercial papers Order No. 192 dated 15 December 2009		
Robinsons Land Corporation		PHP5 billion worth of Fixed-rate Bonds due 2014 - Order No. 103 dated 30 June 2009		
Robinsons Land Corporation		PHP5 billion worth of Fixed-rate Bonds - Order No. 122 dated 11 August 2009		
San Miguel Brewery, Inc.		PHP38 billion worth of Fixed-rate Bonds with an issue price of 100% of face value - Order No. 043 dated 17 March 2009		
SM Investments Corporation		PHP5 billion worth of Fixed-rate Bonds - Order No. 89 dated 8 June 2009		
Tanduay Distillers, Inc.			PHP5 billion worth of Fixed-rate Bonds - Order No. 092 dated 29 January 2010	

Source: Securities and Exchange Commission.

Table 7.4 Domestic Financing versus International Financing (PHP billion)

Year	Domestic Financing (Gross)	International Financing (Gross)	Total (Gross)
2008	978	71	1,049
2009	1,119	251	1,370
2010	1,176	357	1,533

Source: Asian Development Bank, AsiaBondsOnline, Bureau of the Treasury.

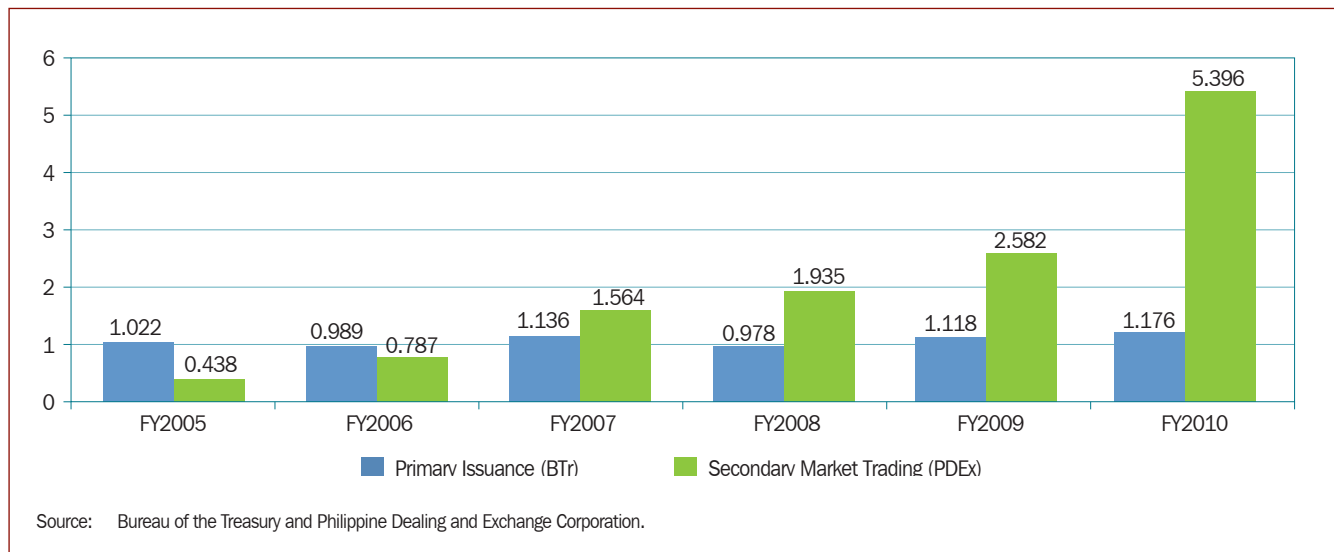
Figure 7.1 Government Securities Primary versus Secondary Market Trading Volume (PHP trillion)

B. Size of Local Currency Bond Market in Percentage of Gross Domestic Product

Table 7.5 Size of Local Currency Bond Market, Percentage Gross Domestic Product (Local Sources)
(USD billion)

Date	Government (% GDP)	Corporate (% GDP)	Total (% GDP)	Government	Corporate	Total
Dec-00	31.1	0.2	31.3	20.83	0.15	20.98
Dec-01	33.8	0.1	33.9	23.77	0.07	23.84
Dec-02	36.9	0.1	37.1	27.31	0.09	27.41
Dec-03	39.4	0.3	39.7	30.66	0.20	30.85
Mar-04	39.7	0.5	40.2	31.31	0.35	31.66
Jun-04	40.1	0.4	40.6	32.66	0.36	33.02
Sep-04	41.3	0.5	41.8	34.60	0.43	35.02
Dec-04	40.9	0.7	41.7	35.47	0.63	36.10
Mar-05	41.0	0.5	41.5	37.34	0.46	37.80
Jun-05	39.6	0.7	40.2	36.36	0.6	36.96
Sep-05	40.6	0.8	41.4	38.28	0.71	38.99
Dec-05	40.1	1.0	41.1	41.13	1.00	42.13
Mar-06	39.4	0.8	40.3	43.19	0.93	44.12

continued on next page

Table 7.5 continuation

Date	Government (% GDP)	Corporate (% GDP)	Total (% GDP)	Government	Corporate	Total
Jun-06	38.1	0.9	39.0	41.10	0.95	42.05
Sep-06	37.3	1.2	38.4	43.61	1.39	45.00
Dec-06	36.6	1.7	38.3	45.03	2.14	47.17
Mar-07	36.2	1.7	37.9	46.22	2.20	48.42
Jun-07	34.3	2.0	36.3	46.94	2.75	49.69
Sep-07	34.9	2.0	36.9	50.00	2.85	52.85
Dec-07	33.8	2.2	36.0	54.50	3.49	58.00
Mar-08	34.5	2.3	36.9	56.10	3.79	59.89
Jun-08	33.8	2.6	36.4	52.52	4.06	56.58
Sep-08	33.6	2.6	36.2	51.68	4.01	55.68
Dec-08	32.2	2.7	34.9	52.25	4.44	56.69
Mar-09	31.5	3.0	34.5	50.90	4.89	55.79
Jun-09	31.2	3.8	35.0	51.02	6.16	57.18
Sep-09	31.7	4.0	35.7	52.90	6.60	59.50
Dec-09	31.9	4.4	36.3	55.47	7.61	63.08
Mar-10	31.9	4.3	36.2	58.43	7.89	66.32
Jun-10	31.5	4.4	35.9	58.15	8.11	66.27
Sep-10	31.9	4.4	36.3	63.83	8.72	72.56
Dec-10	31.3	4.1	35.4	64.34	8.41	72.75
Mar-11	30.0	4.4	34.4	63.60	9.28	72.89
Jun-11	30.9	4.5	35.4	65.46	9.61	75.07

GDP = gross domestic product
Source: AsiaBondsOnline. <http://asianbondsonline.adb.org/philippines/data/bondmarket>.

C. Size of Foreign Currency Bond Market in Percentage of Gross Domestic Product (BIS)

Table 7.6 Foreign Currency Bonds to Gross Domestic Product Ratio (USD billion)

Date	% of GDP	FCY Denominated Bonds	GDP
Dec-95	9.4	6.8	72.8
Dec-96	11.7	9.7	82.6
Dec-97	20.3	12.3	60.7
Dec-98	19.0	13.0	68.7
Dec-99	21.9	16.2	74.0
Dec-00	25.5	17.1	67.1
Dec-01	24.7	17.4	70.4
Dec-02	29.0	21.5	74.0
Dec-03	32.8	25.5	77.7
Mar-04	32.8	25.9	78.9
Jun-04	31.8	25.9	81.4
Sep-04	32.1	26.9	83.7
Dec-04	31.1	27.0	86.6
Mar-05	31.1	28.4	91.2
Jun-05	31.5	28.9	91.9
Sep-05	31.6	29.8	94.2
Dec-05	27.9	28.6	102.6

continued on next page

Table 7.6 continuation

Date	% of GDP	FCY Denominated Bonds	GDP
Mar-06	28.5	31.2	109.6
Jun-06	28.5	30.8	107.9
Sep-06	27.5	32.1	117.1
Dec-06	25.6	31.4	123.0
Mar-07	25.8	32.9	127.7
Jun-07	24.3	33.2	136.9
Sep-07	23.0	33.0	143.4
Dec-07	20.3	32.7	161.2
Mar-08	20.4	33.2	162.5
Jun-08	20.4	31.7	155.5
Sep-08	20.6	31.7	153.7
Dec-08	19.4	31.5	162.5
Mar-09	19.7	31.9	161.7
Jun-09	20.1	32.8	163.4
Sep-09	20.5	34.2	166.8
Dec-09	20.6	35.9	173.9
Mar-10	20.1	36.8	183.0
Jun-10	20.0	36.9	184.3
Sep-10	18.9	37.8	200.0
Dec-10	19.0	39.0	205.6
Mar-11	19.3	41.0	212.0

GDP = gross domestic product; FCY = foreign currency
Source: AsiaBondsOnline. http://asianbondsonline.adb.org/philippines/data/bondmarket.php?code=FCY_in_GDP

D. Size of Foreign Currency Bond Market in US Dollars (Local Sources)

Table 7.7 Foreign Currency Bonds Outstanding (Local Sources) (USD billion)

Date	Government	Banks and Financial Institutions	Other Corporates	Total
Mar-01	11.47	1.49	3.79	16.75
Jun-01	11.31	1.46	3.79	16.55
Sep-01	11.47	1.20	3.78	16.45
Dec-01	12.96	0.83	3.60	17.39
Mar-02	14.47	0.54	3.70	18.71
Jun-02	14.59	0.36	3.70	18.66
Sep-02	16.85	0.54	6.34	23.72
Dec-02	17.02	0.81	6.18	24.01
Mar-03	17.75	0.54	5.85	24.14
Jun-03	17.82	0.54	6.02	24.38
Sep-03	18.52	0.54	6.02	25.08
Dec-03	19.53	0.69	5.75	25.96
Mar-04	20.20	0.69	5.48	26.37
Jun-04	20.49	0.69	5.18	26.36
Sep-04	21.33	0.81	5.18	27.32
Dec-04	21.55	0.81	5.18	27.54
Mar-05	22.68	0.86	5.37	28.91
Jun-05	23.24	0.86	5.37	29.47

continued on next page

Table 7.7 continuation

Date	Government	Banks and Financial Institutions	Other Corporates	Total
Sep-05	24.20	0.86	5.22	30.28
Dec-05	23.24	0.86	4.97	29.07
Mar-06	25.44	1.24	4.87	31.55
Jun-06	25.18	1.24	4.69	31.11
Sep-06	26.14	1.34	4.47	31.94
Dec-06	25.37	1.46	4.37	31.19
Mar-07	26.33	1.45	4.22	32.01
Jun-07	26.26	1.44	3.92	31.63
Sep-07	26.04	1.32	3.86	31.21
Dec-07	26.33	1.32	3.61	31.25
Mar-08	26.95	1.02	3.60	31.58
Jun-08	26.03	1.02	3.30	30.35
Sep-08	25.96	1.02	3.55	30.53
Dec-08	25.98	0.87	3.44	30.29
Mar-09	26.49	0.87	3.44	30.80
Jun-09	27.63	0.85	3.27	31.75
Sep-09	28.48	0.94	3.62	33.04
Dec-09	30.68	0.84	3.62	35.13
Mar-10	31.24	0.94	4.07	36.24
Jun-10	31.24	0.94	4.07	36.24
Sep-10	31.78	1.34	4.69	37.81
Dec-10	32.45	1.64	5.22	39.31
Mar-11	34.12	1.63	5.66	41.41

Source: AsiaBondsOnline. http://asianbondsonline.adb.org/philippines/data/bondmarket.php?code=FCY_Bonds_Outstanding

E. Domestic Financing Profile

Table 7.8 Domestic Financing Profile (USD billion)

Date	Domestic Credit (% of Total)	Bonds (% of Total)	Equity (% of Total)	Domestic Credit	Bonds	Equity	Total
Dec-00	0	45.37	54.63	0	20.98	25.26	46.24
Dec-01	40.68	31.82	27.50	30.48	23.84	20.61	74.93
Dec-02	39.88	36.13	23.99	30.25	27.40	18.20	75.84
Dec-03	36.98	35.98	27.04	31.71	30.86	23.19	85.76
Dec-04	34.39	36.61	29.01	33.91	36.1	28.60	98.61
Dec-05	30.77	35.59	33.64	36.42	42.13	39.82	118.37
Dec-06	28.22	29.33	42.45	45.39	47.17	68.27	160.83
Mar-07	26.23	28.55	45.22	44.49	48.42	76.71	169.62
Jun-07	24.69	26.02	49.29	47.15	49.69	94.12	190.96
Sep-07	25.60	26.82	47.58	50.44	52.85	93.75	197.04
Dec-07	27.37	26.18	46.44	60.63	57.99	102.85	221.47
Mar-08	27.73	30.03	42.24	55.31	59.89	84.23	199.43
Jun-08	29.91	31.27	38.82	54.12	56.58	70.23	180.93
Sep-08	30.12	30.89	38.99	54.31	55.69	70.31	180.31
Dec-08	34.45	34.18	31.37	57.14	56.69	52.03	165.86
Mar-09	32.96	33.70	33.33	54.56	55.79	55.18	165.53

continued on next page

Table 7.8 continuation

Date	Domestic Credit (% of Total)	Bonds (% of Total)	Equity (% of Total)	Domestic Credit	Bonds	Equity	Total
Jun-09	31.17	31.50	37.33	56.57	57.18	67.76	181.50
Sep-09	29.28	30.48	40.24	57.14	59.50	78.54	195.18
Dec-09	29.39	29.81	40.81	62.18	63.08	86.35	211.61
Mar-10	28.18	30.01	41.81	62.28	66.32	92.41	221.01
Jun-10	27.33	28.6	44.07	63.32	66.26	102.10	231.68
Sep-10	25.65	26.58	47.77	69.86	72.37	130.09	272.31
Dec-10	24.26	24.07	51.67	73.87	73.30	157.32	304.49
Mar-11	0	31.44	68.56	0	73.16	159.52	232.68

Source: AsiaBondsOnline. http://asianbondsonline.adb.org/philippines/data/bondmarket.php?code=Domestic_Financing_profile

F. Trading Volume

Table 7.9 Trading Volume (USD billion)

Date	Government Bonds	Corporate Bonds	Total
Mar-05	10.39	-	10.39
Jun-05	47.61	-	47.61
Sep-05	13.40	-	13.40
Dec-05	12.19	-	12.19
Mar-06	21.62	-	21.62
Jun-06	18.15	-	18.15
Sep-06	15.37	-	15.37
Dec-06	14.13	-	14.13
Mar-07	17.39	-	17.39
Jun-07	12.17	-	12.17
Sep-07	15.95	-	15.95
Dec-07	22.10	-	22.10
Mar-08	24.08	-	24.08
Jun-08	10.37	-	10.37
Sep-08	19.39	-	19.39
Dec-08	9.22	-	9.22
Mar-09	21.10	-	21.10
Jun-09	18.73	-	18.73
Sep-09	20.59	-	20.59
Dec-09	15.89	-	15.89
Mar-10	27.49	-	27.49
Jun-10	22.68	-	22.68
Sep-10	58.92	-	58.92
Dec-10	39.48	-	39.48
Mar-11	26.24	-	26.24
Jun-11	24.73	-	24.73

Source: AsiaBondsOnline. http://asianbondsonline.adb.org/philippines/data/bondmarket.php?code=Trading_Volume

VIII. Presence of an Islamic Finance (Sukuk) Market

There is no Islamic finance market in the Philippines.

IX. History of Debt Market Development

A. Total Outstanding Amount of Domestic Government Securities

Table 9.1 Total Outstanding Amount of Domestic Government Securities (PHP billion)

Year	Treasury Bills	Treasury Bonds	Benchmark Bonds	Retail Treasury Bonds	Zero Coupons Bonds	Total
2000	467	536	0	30	0	1,033
2001	425	689	0	68	35	1,218
2002	405	876	0	131	35	1,447
2003	496	942	0	207	41	1,686
2004	578	1,066	0	248	60	1,952
2005	638	1,197	0	232	68	2,134
2006	662	1,014	225	162	68	2,131
2007	614	856	466	174	68	2,178
2008	770	773	576	211	68	2,398
2009	622	742	745	291	60	2,461
2010	527	941	872	314	55	2,709

Source: Bureau of the Treasury.

B. Historical PDEX Trading Volume in Government Securities and Corporate Bonds

Table 9.2 Trading Volume in Government Securities and Corporate Bonds, 2005–2010

	2005	2006	2007	2008	2009	2010
Volume	437.74	787.40	1,564.04	1,935.34	2,581.61	5,396.14
Growth		80%	99%	24%	33%	109%
Average Daily Volume	2.30	3.19	6.41	7.87	10.62	22.12

Source: Philippine Dealing and Exchange System.

C. Major Events that Trigger Market Growth

1. Government Securities Market

Government securities (GS) in the Philippines consist mainly of Treasury bills (T-Bills) and Treasury bonds. The issuance of GS is handled by the Bureau of the Treasury (BTr).

T-Bills are discounted debt instruments primarily used for short-term funding requirements of the national government. They are issued with tenors of 91, 182, and 364 days.

Treasury bonds (also known as Fixed-rate Treasury Notes or FXTNs), on the other hand, have maturities greater than a year. They are issued in 2-, 3-, 4-, 5-, 7-, 10-, 20-, and 25-year tenors. The bonds pay coupon or interest on a semi-annual basis. From time to time, the government also issues zero coupon bonds.

In 2001, the government started issuing retail treasury bonds (RTB) as part of the government's savings mobilization program designed to make government securities available to retail investors and, at the same time, create savings consciousness among Filipinos.

With RTBs, investors can buy debt paper for a minimum amount of PHP5,000. GS dealers or selling agents of these bonds are required to sell a minimum of 55% of their total subscription to retail investors. Retail investors are defined as investors other than a Government Securities Eligible Dealers (GSED), Government Service Insurance System, Social Security System, Philippine Health Insurance Corporation, Home Development Mutual Fund, and investment houses and subsidiaries of GS dealers or investment houses performing banking and/or quasi-banking functions. RTBs pay coupon or interest on a quarterly basis. Last March 2011, the government sold a total of PHP104 billion worth of RTBs to retail investors and state-owned companies.

Beginning 2006, the BTr started conducting domestic bond exchanges as part of the liability management program of the Government to smoothen its debt maturity profile, extend the duration of its existing peso liabilities, and establish a benchmark for long-term financing to support government initiatives that promote public-private partnership for infrastructure and economic development. As benchmark bonds are issued in substantial amounts, they tend to be more liquid and trade more efficiently in the secondary market.

To date, the BTr has issued 12 benchmark bonds with 3-, 5-, 7-, 10-, 10.5-, 20-, and 25-year tenors. The most recent bond exchange was held last 19 July 2011 where a landmark PHP323.4 billion of long 10- and 20-year benchmark bonds were issued.

On 29 April 2010, the government issued the first tranche of the USD400 million and EUR75 million denominated multicurrency retail treasury bonds (MRTB) to provide overseas Filipino workers (OFWs) and migrant Filipinos, and their families a safe haven for their hard-earned foreign currency savings. To entice OFWs and

migrants to invest in MRTB, they were granted a tax incentive privilege whereby the government assumes the 20% final withholding tax on the interest income on the bonds.

Peso-denominated government securities are listed and traded in Philippine Dealing Exchange.

The US dollar tranche of the MRTB is the first foreign currency-denominated security to be listed and traded in PDEX, across investors of different tax categories.

2. PDEX Corporate Securities Market

PDEX launched its corporate securities trading board in November 2007, with the admission of the maiden corporate issue in the PDEX market—a large industrial group's fixed-rate bond due in 2012—for trading on the Inter-Professional Market.

PDEX expanded its trading market to the public in 2008, paving the way for the maiden listing of the bonds that were traded on the Inter-Professional Market, so that the public could have access to these instruments. The listing of bonds of other large corporations followed. PDEX likewise witnessed the entry of bank issues in 2009, and a quasi-sovereign issue in 2010.

As of June 2011, a total of Php195.8 billion of outstanding corporate securities, issued by 16 corporations across 31 instruments, were listed and traded on PDEX, with the issuer community much diversified across the realty, food and beverage, utilities, bank, telecommunications and other sectors.

X. Next Step ⇔ Future Direction

The Philippine fixed-income market over the past 5 years has concentrated its efforts in bringing itself into an organized and orderly environment. The process does not end with the organization of the market. Market actors and stakeholders consider the organization of the spot market as a necessary step to create market structures that are envisioned to strengthen the spot market and make it more robust.

Hence, the market is committed in the coming years to bring focus to the following areas:

- (i) Bond market liquidity enhancement;
- (ii) Developing private debt issue markets;
- (iii) Developing hedge or protection markets;
- (iv) Strengthening clearing and risk management of securities and currencies; and
- (v) Regional cooperation.

Discussed below are the initiatives on each commitment in greater detail.

A. Bond Market Liquidity Enhancement

1. Market Liquidity

It is noted that the tax environment of debt issues is a major cause for the segmentation of the market. In particular, the present organized market has been limited to that segment of the community that is subjected to a final withholding tax on interest payments. Consequently, the tax-exempt segment of the market has been left in the periphery of the organized market. This market segmentation has kept a large pool of securities liquidity away from the organized market; in government securities alone, tax-exempt investments count for as much as one-third of the national government's outstanding issue.

This market segmentation can be alleviated by the introduction of systems that are capable of tracking purchase histories and accounting for taxes that should be levied against taxable entities on the basis of holding periods. In the US dollar-denominated government securities market, the organized market has mobilized this capability, and

created a new environment where taxable and tax-exempt entities can transact freely with one another. This new environment can be launched for all other securities, and processes are underway to clear the systems, processes, and technology attendant to bring into play the integrated environment.

2. Cash Liquidity

The organized market looks forward to the creation and strengthening of market programs that can contribute to greater cash liquidity in the market, so that market players are equipped with the necessary tools to support their trading activities. In the coming years, these efforts would include: (a) the repurchase agreement markets and (b) securities financing programs.

a. Repurchase agreement markets. The organized market has launched a repurchase agreement capability to assist dealers in firming up trade commitments in the market. The current repo market is an inter-professional market, participated in by dealers as repo sellers, and qualified investors and dealers as repo buyers. While a slow and steady growth was witnessed in its early years, the need for a well-defined tax environment is needed to nurture this growth and make the program a relevant market tool for liquidity. Tax regulatory authorities must deeply understand the function of the program in order to align tax policy with market dynamics.

b. Securities financing. To enable a wider community access to cash facilities to support trading activities, a securities financing program should be installed.

3. Securities Liquidity

To supplement the cash liquidity tools for the market, the organized market also looks forward to the strengthening of securities liquidity programs to equip market players with the necessary tools to support their trading activities. In the coming years, these efforts would include the growth of the securities lending program.

A defined securities lending program has been available to the market. However, the market has been shied away from using the program. Efforts are underway to create a market impetus for the utilization of the program, so that it can function as a market tool to boost securities liquidity.

4. Issue Liquidity

A vital contributor to market liquidity is the creation of an environment that would boost liquidity of issues listed for trading in the organized market. In particular, the government is interested in launching and institutionalizing programs that would rationalize its bond issuances to ensure optimal tradability of its issues.

a. Continuous Switch and Swap Program. The Continuous Switch Program is envisioned to operate as a fails settlement mitigant and as a critical tool in identifying issues that are losing tradability in the market. Under the envisioned program, market makers will be provided an opportunity on any given day to switch securities, which they consider to be losing tradability with more liquid issues of government securities. This mechanism will ensure that untradeable issues are swept out of the market and replaced with more tradable issues. A Continuous Swap Program may also be operationalized to allow dealers to swap illiquid issues with more liquid ones on a scheduled basis.

b. Securities stripping. A program is in the early stages of development to enable the creation of new securities from the coupons of outstanding securities (strips), including packaging of strips, so that the issues can gain depth and attractiveness to the market base.

5. Market Maker Programs

The national government, through the Bureau of the Treasury (BTr), envisions a full-scale program that would identify entities that are committed to merchandize its issue, and provides a suite of support facilities that would assist these specialists in delivering on their commitments and incentives that would reward them for the performance of their obligations. These facilities include support systems from the BTr in the repo and securities lending programs, as well as the continuous switch and continuous swap facilities.

B. Development of Private Debt Issue Markets

The bond market has begun corporate securities trading, and has witnessed the entry of various corporate securities into the marketplace, from varied sectors and with varying features to suit investors' needs. Market actors and stakeholders look forward to building further on this growth to develop the qualified notes market (securities issued to a restricted number of investors), the securitized markets (creation of an organized marketplace for the trading of asset-backed securities), and the exchange-traded funds (making the market venue available for exchange traded funds). Efforts have begun along these lines, with regulatory discussions already under way to pave the way for these expansions to take place.

C. Institutionalization of Hedge and Protection Markets

As the spot market gains in development, strength and robustness, the market shows readiness for the institutionalization of hedge markets in the near future. These markets, including interest-rate swaps, non-deliverable forwards, and forward rate agreements, are envisioned to provide exit points out of the market, in ways that would not unduly impact the spot market. Initiatives to institutionalize the market structure can only go forward under a clearly defined regulatory environment.

D. Strengthening Clearing and Risk Management Securities and Currencies

Parallel to other future initiatives, the Philippines also needs to strengthen its clearing and risk management environments both for securities and currencies. The key initiatives included in the Philippine roadmap are:

1. Margins

Use of margins shall be developed to collateralize counterparty credit risk, both in response to the Basel capital requirements for financial institutions, as well as to afford equal access to trading markets by trading participants of varying capitalization. A specific example is the proposed Multilateral Trading Program of the

PDS Group, which seeks to cover the pre-settlement risk of trading counterparties through the delivery of margin collaterals, which are translated to trading limits in the trading system.

2. Netting

The use of exposure or position netting is also being explored for certain products, whether bilateral or multilateral, as a means to reduce final settlement obligations and promote settlement efficiency. One potential candidate for netting are the foreign exchange spot market trades, where bilateral netting would achieve a netting efficiency of 70% in terms of trade count and 45% in terms of value. Efficiencies through multilateral netting are even more dramatic at 98% in terms of trade count and 75% in terms of value. Similar studies are being conducted for other asset classes, notably fixed-income securities and eventually the hedge products.

3. Central Clearing

Centralized clearing and risk management is also being considered as a natural consequence of the organization of the markets. Whether this centralization will involve the use of a central counterparty is also part of the study fully recognizing that the heterogeneity of Philippine market players is best served by adopting a tiered clearing concept with a select group of qualified clearing members representing non-clearing members.

E. Regional Cooperation

The Philippines is committed to regional discussions that would allow the domestic market to expand its reach. In this regard, it contributes to the dialogue opened by the Asian Bond Market Forum and hopes for sustained cooperation on the notion that domestic issuers can access foreign investors, and the trading community can extend their activities in organized markets offshore. A central premise of this endeavor is the ability to go beyond local borders while preserving domesticity of our issues. In this regard, support is given to these initiatives that focus on:

1. Regulatory Harmonization

Any endeavor to cooperate on a regional level must institute measures to ensure that appropriate regulation is in place to safeguard the activity. Hence, the thrust to look outward and join the regional discussion may lay serious focus on harmonizing regulatory frameworks to the extent possible. This assures a level playing field among countries that desire a cooperative relationship moving forward and predictability in the way a regional market will operate, which is essential to building a stable and sustainable market.

2. Tax Treaty Implementation

While tax treaty implementation has been underway to enforce treaty obligations between bound states, the organized market looks to streamlining the process to be responsive to the needs of a fast-paced and dynamic marketplace, without compromising the taxing authority's verification requirements for the application of preferential treaty rates.

3. Institutionalization of Market Access

As markets unite and link with each other, the notion of organization and order remains at the forefront of the vision for regional cooperation. The organized markets within the region are envisioned to create the links that would give life to a regional trading venue that proceeds on the basis of order and cooperative processes for trading, clearing and settlement.

F. Group of 30 Compliance⁵⁶

The so-called G-30 Recommendations were originally conceived as the Group of Thirty's Standards on Securities Settlement Systems in 1989, detailing in a first of its kind report nine recommendations for efficient and effective securities markets and covering legal, structural and settlement process areas. The recommendations were subsequently reviewed and updated in 2001, under leadership of the Bank for International Settlements (BIS), and through the efforts of a Joint Task Force of the Committee On Payment and Settlement Systems (CPSS) and the Technical Committee of the International Organisation of Securities Commissions (IOSCO). Compliance with the G30 Recommendations in individual markets is often an integral part in securities industry participants' and intermediaries' due diligence process.

Table 10.1 Group of Thirty Compliance

Recommendation		Implemented
1	Eliminate paper and automate communication, data capture, and enrichment.	No Not all bonds are dematerialized or immobilized.
2	Harmonize messaging standards and communication protocols.	No The local CSD and most local market participants do not use SWIFT.
3	Develop and implement reference data standards.	No There is no securities' numbering agency for bonds. The Bureau of the Treasury issues its own ISIN-like numbering for government securities while PDEX assigns series name following the same convention for listed corporate securities.
4	Synchronize timing between different clearing and settlement systems and associated payment and foreign exchange systems.	Yes
5	Automate and standardize institutional trade matching.	Yes For government and listed corporate bonds
6	Expand the use of central counterparties.	No
7	Permit securities lending and borrowing to expedite settlement.	Yes
8	Automate and standardize asset servicing processes, including corporate actions, tax relief arrangements, and restrictions on foreign ownership.	No
9	Ensure the financial integrity of providers of clearing and settlement services.	Yes

continued on next page

⁵⁶ Group of 30 (G30). 2003. *Global Clearing and Settlement – A Plan of Action*. <http://www.partad.ru/wrld/word/g30app1.pdf>

Table 10.1 continuation

Recommendation		Implemented
10	Reinforce the risk management practices of users of clearing and settlement service providers.	Yes
11	Ensure final, simultaneous transfer and availability of assets.	Yes Existing central bank regulations on investments in fixed-income securities by foreign investors only allow the foreign investors to contract a FX deal to sell PHP and buy foreign currency upon actual receipt of the license to be issued by the central bank.
12	Ensure effective business continuity and disaster recovery planning.	No
13	Address the possibility of failure of a systematically important institution.	No
14	Strengthen assessment of the enforceability of contracts.	Yes
15	Advance legal certainty over rights to securities, cash, or collateral.	Yes
16	Recognize and support improved valuation methodologies and closeout netting arrangements.	Yes
17	Ensure appointment of appropriately experienced and senior board members (to the boards of securities clearing and settlement infrastructure providers).	Yes
18	Promote fair access to securities clearing and settlement networks.	Yes
19	Ensure equitable and effective attention to stakeholder interests.	Yes
20	Encourage consistent regulation and oversight of securities clearing and settlement service providers.	Yes

CSD = Central Securities Depository; SWIFT = Society for Worldwide Interbank Financial Telecommunication; ISIN = International Securities Identification Number; FX = Foreign Exchange
Source: Group of 30 (G30). 2003. *Global Clearing and Settlement – A Plan of Action*.

G. Group of Experts (GoE) Barrier Report Market Assessment – Philippines (April/2010)

The GoE Report refers to the published results in 2010 of the Group of Experts (GoE) formed under Task Force 4 of the Asian Bond Market Initiative (ABMI). In the report, published under the leadership of the Asian Development Bank (ADB), a group of securities market experts from the private and public sector in ASEAN+3, as well as International Experts, assessed the ASEAN+3 securities markets on potential market barriers, the costs for cross-border bond transactions, and the feasibility for the establishment of a Regional Settlement Intermediary (RSI). The findings in the GoE Report lead to the creation of ABMF.

Table 10.2 Summary of Barriers Market Assessment – Philippines (April 2010)

Potential Barrier Area	Current Situation	Market Assessment Questionnaire Scores	Overall Barrier Assessment
Quotas	No restrictions are placed on foreigners investing in Philippine securities.	OK	OK
Investor registration	Foreign investments need not be registered with the BSP unless the Foreign Currency needed to service the repatriation of capital and the remittance of dividends, profits and earnings is purchased from the banking sector. These restrictions are therefore covered under repatriation of funds.	OK	OK

continued on next page

Table 10.2 continuation

Potential Barrier Area	Current Situation	Market Assessment Questionnaire Scores	Overall Barrier Assessment
FX controls-conversion	<p>FX requires evidence of an underlying securities transaction, if the funds are to be eligible for subsequent repatriation.</p> <p>Third-party foreign exchange trades are permitted. The third-party bank must send the CIR to the sub-custodian bank at the same time it transfers the peso, otherwise it is not possible to raise a BSRD, thereby preventing subsequent repatriation. Offshore FX (pesos or US dollars) is allowed provided peso cover is done onshore.</p> <p>Circular 645 (issued February 2009) allows local custodians to issue the BSRD for inward foreign investments in government securities on behalf of the BSP</p> <p>It is noted that there is an ongoing dialogue between BSP and the custodian banks to streamline the reporting requirements.</p>	LOW	LOW
FX controls - repatriation of funds	<p>There are no restrictions on the amount of currency that can be remitted or repatriated subject to submission to BSP of required documentation. However, the repatriation of funds must be accompanied by a BSRD together with the required supporting documents.</p> <p>The regulations only allow the foreign investors to sell peso and buy Foreign Currency upon actual receipt of the license to be issued by the BSP; there is no standard processing period which may range from 1 week to 2 weeks for government securities and longer for corporate bonds. The BSP may also require additional documentation, giving the impression that the process is somewhat arbitrary.</p> <p>Purchases of pesos intended for securities investments that are ultimately cancelled cannot be repatriated unless the peso is first re-invested.</p> <p>Overall, a considerable burden is placed on the custodian bank.</p> <p>It is at the time of repatriation, rather than the original inward investment, that problems are most likely to occur.</p>	LOW	HIGH
Cash controls - credit balances	<p>Cash credit balances are permitted.</p> <p>BSRD-eligible transactions include investments in listed securities, government debt, and time deposits or other money market instruments with maturities of 90 days or greater.</p> <p>Foreign investors can open interest-earning accounts.</p>	LOW	OK
Cash controls - overdrafts	<p>Peso overdrafts to non-residents are not permitted. This means that foreign investors must ensure that cash accounts are adequately funded (cleared funds) prior to settlement date. Foreign broker-dealer clients, who do intra-day trading, are especially affected by this restriction, and difficulties arise if the sale side fails.</p> <p>Market authorities have pointed out that with the recent regulation allowing non-residents to do FX swaps, the above concern has been addressed.</p>	LOW	HIGH
Taxes	<p>Both resident and non-resident investors are subject to withholding tax of 20% on the interest from government bonds, and 30% on the interest from corporate bonds (recently reduced from 35%). These rates are high by international standards.</p> <p>For non-residents, the withholding tax rate may be reduced under a double taxation agreement. Eligible investors must submit all necessary documentation to the BIR. The documentation is fairly onerous. Investors have also commented that the requirements are not clear. For government securities, investors must also confirm to the Bureau of the Treasury that it is a 'buy-to-hold' portfolio.</p> <p>Tax reclaims are available via direct filing with the BIR, but take years and are rarely successful.</p> <p>A number of market participants mentioned Philippines as a problem in this area.</p>	HIGH	HIGH
Omnibus accounts	<p>Foreign investors are permitted to use omnibus accounts.</p>	OK	OK

continued on next page

Table 10.2 continuation

Potential Barrier Area	Current Situation	Market Assessment Questionnaire Scores	Overall Barrier Assessment
Settlement cycle	The settlement cycle for local bond trades is T+0. However, for cross-border bond trades it is T+2 (or by agreement).	OK	OK
Message formats	The local CSD and most local market participants do not use SWIFT. A number of market participants mentioned Philippines as a problem in this area.	LOW	LOW
Securities numbering	ISIN codes are available for all local bonds, and are available for new issues at issue date. Most local market participants use ISIN. However, the local CSD uses local securities codes.	LOW	LOW
Matching	There is a trade matching system for government securities and some listed corporate bonds. There is a pre-settlement matching system for government securities among GSEDs.	OK	OK
Dematerialisation	Not all bonds are dematerialised or immobilised.	LOW	LOW
Regulatory framework	Investors commented that rules and regulations are clear. However, there can be abrupt regulatory changes, which create regulatory risk.	-	LOW

BIR = Bureau of Internal Revenue; BSF= Bangko Sentral ng Pilipinas; BSRD = Bangko Sentral Remittance Document; CIR = Certificate of inward Remittance; GSED = Government Securities Eligible Dealers
Source: Asian Development Bank. 2010. Asian Bond Market Initiative Group of Experts Final Report: Barriers to Cross-Border Investment and Settlement in the ASEAN+3 Bond Markets. [https://wpqr1.adb.org/LotusQuickr/asean3goe/Main.nsf/h_58E34A1388F9070B48257729000C0A4E/90F408746827C16248257729000C1334/\\$file/Part3.pdf](https://wpqr1.adb.org/LotusQuickr/asean3goe/Main.nsf/h_58E34A1388F9070B48257729000C0A4E/90F408746827C16248257729000C1334/$file/Part3.pdf)

References:

- Asianbondsonline website (www.asianbondsonline.adb.org)
- Securities and Exchange Commission (www.sec.gov.ph)
- Bangko Sentral ng Pilipinas (www.bsp.gov.ph)
- Bureau of the Treasury (www.treasury.gov.ph)
- Philippine Dealing Exchange (www.pdex.com.ph)
- Money Market Association (www.mart.com.ph)

Singapore Bond Market Guide

Contents

Acknowledgement	vii
I. Structure, Type and Characteristics of the Bond Market.....	1
A. Overview	1
B. Descriptions for the Bond Market in Singapore	2
C. The Securities and Futures Act 2001	5
D. Definition of Relevant Person	8
E. Definition of Accredited Investor, Expert Investor, and Institutional Investor	8
F. Descriptions of Public Offering	10
G. Provisions on Private Placement	12
H. Brief Summary of Exemptions from Prospectus Requirements.....	14
I. Overview of the Singapore Exchange Bond Listing Criteria	15
J. General Guide for Singapore Exchange Bond-Listing Requirements	15
K. Summary of Listing Criteria of Foreign Debt Securities on the Singapore Exchange	16
L. General Listing Procedures	18
M. Reference for Singapore Government Securities Listing	20
N. Singapore Exchange Rulebook on Debt Securities	20
O. Placement of Bonds in the Primary Market.....	20
P. Secondary Market Trading	21
Q. Methods of Issuing Bonds	22
R. Credit Rating Agencies and the Credit Rating of Bonds	23
S. Bond Related Systems for Investor Protection	24
T. Trustee System	25
U. Governing Laws on Bond Issuance.....	26
V. Definition of Securities	27
W. Related Legal and Regulatory Issues Behind the Market	29
X. Self-Governing Rules Behind the Market	30
Y. Bankruptcy Procedures.....	31
II. Primary and Secondary Markets Regulatory Framework	32
A. Regulations and Rules on Issuing Debt Instruments	32
B. Secondary Market-Related Regulations and Rules on Buying Debt Instruments	33
C. Financial Sector Incentive Tax Regimes.....	34
D. Taxation Framework and Tax Requirements	36

III. Trading of Bonds and Trading Market Infrastructure.....	39
A. Exchange Trading and Over-the-Counter Trading	39
B. Exchange Trading of Bonds	40
C. Primary Dealer System	42
D. Bond Repurchase Market.....	43
E. Transparency in Bond Pricing	44
IV. Description of the Securities Settlement System.....	46
A. Dematerialization or Immobilization versus Physical Securities	46
B. Clearing and Settlement System in Singapore	46
C. The Monetary Authority of Singapore Electronic Payment System	47
D. Bond Market Infrastructure Diagram.....	48
E. Business Process Flowchart Level 2: Singapore Bond Market and Delivery versus Payment.....	48
F. Over-the-Counter Bond Transaction Flow for Foreign Investors.....	50
G. Settlement Schemes for Government Bonds, Corporate Bonds and Other Bonds.....	51
VI. Costs and Charging Methods	52
A. Exchange Fees	52
VII. Market Size and Statistics	54
A. Size of Local Currency Bond Market in Percentage of Gross Domestic Product (Local Sources).....	54
B. Issuance Volume of Local Currency Bond Market.....	55
C. Bond Trading Volume	56
D. Breakdown of Local Currency Government Bond Market Issuance	57
E. Size of Foreign Currency Bond Market	59
F. Size of Foreign Currency Bond Market (Local Sources)	60
G. Domestic Financing Profile.....	61
VIII. Next Step ⇒ Future Direction	62
A. Future Direction	62
B. Group of 30 Compliance	63
C. Group of Experts Final Report: Summary of Barriers Market Assessment (April 2010)	64
Appendixes	66

Boxes, Figures, and Tables

Boxes

Box 1.1	Part XIII of the Securities and Futures Act 2001	5
Box 1.2	Article on the Launch of the OPERA.....	11
Box 1.3	Provisions on Private Placement in the Securities and Futures Act	13
Box 1.4	Duties of Trustees	25
Box 1.5	Provisions on the Amendment to the Definition of Securities.....	29
Box A1.1	Securities and Futures Act (SFA) 2001 (CHAPTER 289)	66
Box A2.1	Singapore Exchange Rulebook.....	156

Figures

Figure 1.1	Timeline of Registration Process	12
Figure 1.2	General Listing Procedure	19
Figure 3.1	Changes in the Singapore Exchange Trading Hours	42
Figure 4.1	Bond Market Infrastructure.....	48
Figure 4.2	Business Process Flowchart Level 2	49
Figure 4.3	Over-the-Counter Bond Transaction Flow for Foreign Investors	50

Tables

Table 1.1	Characteristics of Singapore Government Securities.....	3
Table 1.2	Criteria for Listing	15
Table 1.3	Auction Information	21
Table 1.4	Secondary Market Information.....	21
Table 1.5	Auction Conduct	22
Table 1.6	Definitions of Securities under the Securities and Futures Act 2001	28
Table 1.7	Singapore Exchange Monthly Market Statistics, October 2011.....	31
Table 2.1	Details of the Approved Special Purpose Vehicles	35
Table 2.2	Details on the Tax Change Provisions.....	36
Table 2.3	Summary of Regulatory and Tax Information.....	38
Table 3.1	Fixed Income Products on the Singapore Exchange.....	39
Table 3.2	Minimum Bid Size for Debentures	40
Table 3.3	Revised Hong Kong Dollar and Japanese Yen Minimum Bids Schedule.....	40
Table 4.1	Main Changes to Settlement Timings	47
Table 5.1	Selected Costs and Charging Methods in the Singapore Bond Market.....	53
Table 6.1	Size of Local Currency Bond Market (% GDP)	54
Table 6.2	Issuance Volume of Local Currency Bond Market (\$ billions)	55
Table 6.3	Trading Volume (\$ billions)	56
Table 6.4	Government Issuance Breakdown (\$ billions)	57
Table 6.5	Foreign Currency Bonds to Gross Domestic Product Ratio (\$ billions).....	59
Table 6.6	Foreign Currency Bonds Outstanding (\$ billions)	60
Table 6.7	Domestic Financing Profile	61
Table 7.1	Group of 30 Compliance	63
Table 7.2	Group of Experts Summary of Barriers Market Assessment – Singapore	64

Acknowledgement

The Asian Development Bank (ADB) Team, comprising Satoru Yamadera (Economist, ADB Office of Regional Economic Integration, September 2011), Seung Jae Lee (Principal Financial Sector Specialist), Shinji Kawai (Senior Financial Sector Specialist, Banking), Shigehito Inukai (ADB consultant), Taiji Inui (ADB consultant), and Matthias Schmidt (ADB consultant), would like to express our sincere gratitude to Citibank, Deutsche Bank AG, Hongkong Shanghai Banking Corporation, J.P. Morgan, and State Street for their contribution as international experts, for providing information from their own market guides, as well as their valuable expertise. Particular thanks to DBS Bank for providing us with the “Securities Market Guide.” Because of their cooperation and contribution, the ADB Team started the research on solid ground.

We would also like to express special thanks to the team at the Monetary Authority of Singapore (MAS) for repeatedly reviewing the draft versions of the market guide.

It should be noted that any part of this report does not represent official views and opinions of any institution that participated in this activity as members and experts of the ASEAN+3 Bond Market Forum.

The ADB Team has sole responsibility for the contents of this report.

February 2012

Asian Development Bank (ADB) Team

I. Structure, Type and Characteristics of the Bond Market

A. Overview

Singapore has one of the most developed bond markets in Asia. The Singapore bond market has become an open capital market in Asia over the past decade and a half. As of the second quarter of 2011, market capitalization was around SGD250.5 billion, of which 60% was in Singapore dollars and the rest mostly in US dollar, euro and yen. Sovereign bonds and statutory board bonds are vital features of the market, despite the government's strong fiscal position that does not require deficit financing.

Singapore Government Securities (SGS)—comprising Treasury bills and bonds—are issued primarily to stimulate market activity and provide a benchmark for corporate issues. SGS are also targeted to satisfy reserve requirements for Singapore-based financial institutions (both banks and non-banks), and are sought-after as collateral for repurchase transactions.

The Singapore dollar bond market comprises SGS, statutory board bonds, corporate bonds, and structured securities. Statutory board papers, issued by autonomous government agencies, are considered relatively liquid among debt instruments on the Singapore corporate bond market. As for issuance by corporates, property-related companies continue to be key issuers of Singapore dollar denominated corporate debt securities, while structured products include equity-linked notes, convertible bonds, credit-linked notes, and asset securitization transactions.

Islamic finance is growing as well. In 2005, Singapore was accepted as a full member of the Islamic Financial Services Board (IFSB), an international body based in Malaysia that defines regulatory and supervisory standards governing Islamic financial services. In January 2009, Singapore launched its first Islamic bond program worth SGD200 million. Market capitalization was around SGD250.5 billion, as of the second quarter of 2011, of which 60% was in Singapore dollars and the rest mostly in US dollars, euro and yen.

To attract greater foreign interest, the Monetary Authority of Singapore (MAS) began internationalizing the Singapore dollar in 1998, with foreign entities allowed to issue

Singapore dollar-denominated bonds. Singapore's debt market has grown to become a source of financing for local and foreign corporations, international organizations, and governments.

In January 2005, Singapore was the first Asian nation outside of Japan to join the widely-followed Citigroup World Government Bond Index (WGBI). SGS are also included in other leading indices such as the J.P. Morgan World Government Bond Index and the HSBC Asian Local Bond Index.

From 8 July 2011, individual investors were able to trade SGS bonds in the secondary market on the Singapore Exchange. Market makers, who are also SGS primary dealers, committed to provide two-way prices for the SGS bonds traded on the Exchange. With the new offering by SGX, investors were able to access SGS bond prices on SGX's website or through their brokers, and trade SGS bonds through their brokers in a manner similar to the way stocks are traded. Trading of SGS and corporate bonds remains over-the-counter (OTC) for institutional investors.

A total of 20 SGS bonds amounting to SGD82.3 billion are currently traded on the SGX, with maturities of 2 years or more. SGX's Central Depository (Pte.) Limited (CDP) acts as the custodian of SGS bonds traded on the exchange.

B. Descriptions for the Bond Market in Singapore

1. Description of Each Bond

a. Singapore Government Securities

Singapore Government Securities (SGS) were initially issued to meet banks' needs for a risk-free asset in their liquid asset portfolios. In 1998, MAS spearheaded efforts to enhance the efficiency and liquidity of the SGS market as part of its strategy to develop Singapore as an international debt hub. This was further refined in May 2000 with the introduction of a focused issuance program aimed at building large and liquid benchmark bonds, primarily through larger issuance of new SGS bonds and re-opening of existing issues, to enlarge the free float and occasional bond purchase programs to re-channel liquidity from off-the-run issues to benchmark bonds. Since then, the SGS market has grown significantly.

MAS is the fiscal agent of the Singapore Government. As such, it is empowered by the *Development Loan Act* and the *Government Securities Act* to undertake the issuance and management of securities on behalf of the government. The amount of SGS issued is authorized by a resolution of Parliament and with the President's concurrence. Each year, MAS seeks approval from the Minister for Finance for the total amount of SGS issuance for the new financial year. MAS decides, in consultation with the SGS primary dealers, the timing and amount of individual bond issues.¹

¹ Detailed information on Singapore Government Securities market can be found at the SGS website. <http://www.sgs.gov.sg/index.html>

SGS are issued by the MAS, on behalf of the Government of Singapore. Unlike many other countries, the Singapore Government does not need to finance its expenditures through the issuance of government bonds as it operates a balanced budget and often enjoys budget surpluses. This allows the government to focus on the development of Singapore's capital markets instead, and the issuance of SGS serves primarily to:

- (i) Build a liquid SGS market to provide a robust government yield curve for the pricing of private debt securities;
- (ii) Foster the growth of an active secondary market, both for cash transactions and derivatives, to enable efficient risk management; and
- (iii) Encourage issuers and investors, both domestic and international, to participate in the Singapore bond market.

SGS comprise marketable short-term T-bills and medium- and long-term bonds. SGS T-bills are zero-coupon, and issued and traded on a discount basis. On the other hand, SGS Treasury bonds carry a fixed semi-annual coupon paid on the first and 15th of the particular month. They are non-callable or non-puttable bonds with bullet redemptions.

SGS T-bill and bond auctions are held on a regular basis. Three-month T-bills are issued weekly, while 1-year T-bills and bonds are issued according to an annual issuance calendar.

The key characteristics of both securities are summarized in Table 1.1.

Table 1.1 Characteristics of Singapore Government Securities

	Treasury bills	Bonds
Issuer	Singapore Government	Singapore Government
Tenor	3M and 1Y	2Y, 5Y, 10Y, 15Y, 20Y (7Y non-benchmark)
Interest Rate	Discount	Fixed Coupon
Coupon Payments	N/A	Semi-annual (Every 6 months)
Minimum Denomination	SGD1,000	SGD1,000
Typical Issue Size	SGD2.3 billion–SGD4.0 billion	SGD2 billion–SGD3 billion for benchmark issues
M = months, Y = years Source: Monetary Authority of Singapore. www.sgs.gov.sg/market_characteristics/mktchar_auctions.html		

b. Corporate Bonds

Singapore's corporate bond market is mainly composed of statutory board bonds, domestic bonds, and non-domestic bonds open to both local and foreign investors. Corporate bonds are generally bought and traded over the counter.

i. Statutory Board Bond Issuers

Statutory boards of the Singapore Government are autonomous organizations whose issues generally imply good credit ratings even though there may not be an explicit guarantee given by the government. Statutory board papers are considered the most

liquid among debt instruments on the Singapore corporate bond market. The three largest statutory board issuers are:

- (a) The Housing Development Board, the public housing authority that plans and develops public housing, under the Ministry of National Development;
- (b) The Land Transport Authority, a statutory board under the Ministry of Transport, which leads land transport developments; and
- (c) The PUB, the national water agency responsible for collection, production, distribution and reclamation of water.

ii. Domestic Corporate Bond Issuers

Domestic corporate bond issuers are mainly composed of property-related companies, statutory boards, financial institutions, Government-linked companies (GLCs), and other non-property related companies. The GLCs include companies such as Singapore Airlines, SingTel, DBS Bank, SMRT Corporation, and PSA Corporation.

iii. Non-Domestic or Foreign Bond Issuers

The Singapore dollar bond market is fully accessible to all issuers globally. There are no capital controls, hedging restrictions or withholding taxes. Non-domestic Singapore dollar corporate bond issues are composed of supranational, quasi-sovereign agencies, banks, and other corporations. The market's profile is international in nature, with foreign entities accounting for more than a quarter of bond issuance annually. These include the Asian Development Bank, Cheung Kong Holdings and Export-Import Bank of Korea among others.

Non-domestic Singapore dollar corporate bond issues are, for the most part, composed of supranational agencies, foreign banks, and foreign corporations from the United States, Europe, and Asia. These include Citigroup, Merrill Lynch & Company, and the Asian Development Bank, among others. Some, but not necessarily all, of these non-domestic Singapore dollar corporate bond issues are issued under the SGX Listed Euro-Medium Term Note (EMTN) Programme. The Singapore corporate bond market uses a wide range of debt structures that include fixed- and floating-rate notes (FRN), asset-backed securities (ABS), equity-linked notes, mortgage-backed securities (MBS), and many other structured products. If an issuer intends to use the proceeds outside Singapore where a currency swap facility exists, the swap tenure must match the bond tenure.

The structured note market continues to grow and comprises about half of the outstanding corporate issuance. The number of SPVs illustrates the importance of structured notes to the Singapore dollar market. The commercial mortgage-backed securities (CMBS) market has taken off largely through real estate investment trusts (REITs), which have been large issuers of CMBS. REITs offer investors access to a portfolio of property assets including commercial, retail, industrial and residential properties; and usually pay a dividend based on net proceeds from the property portfolio, rather than a coupon.²

² Monetary Authority of Singapore. *Overview of the Singapore Corporate Bond Market*. http://www.mas.gov.sg/fin_development/debt_market/The_Singapore_Corporate_Bond_Market.html

C. The Securities and Futures Act 2001

The Securities and Futures Act 2001 (the SFA) is the single key piece of securities market regulation that integrates provisions on investors, issuers and issuance types, investor protection as well as market conduct. It, hence, has significance across all aspects of the securities market and will be referred to frequently in the course of this document. Additional laws and regulations effectively supplement the SFA, and are detailed further in Chapter II, sections A. and B. Box 1.1 shows the different articles contained under Part XIII of the Securities and Futures Act 2001 (SFA).³

Box 1.1 Part XIII of the Securities and Futures Act 2001

Securities and Futures Act (SFA) 2001
CHAPTER 289
2006 REVISED EDITION

PART XIII

OFFERS OF INVESTMENTS

Division 1—Shares and Debentures

SUBDIVISION (1)—Interpretation

- 239 Preliminary provisions
- 239A Authority may disapply this Division to certain offers
- 239B Modification of provisions to certain offers

SUBDIVISION (2)—PROSPECTUS REQUIREMENTS

- 240 Requirement for prospectus and profile statement, where relevant
- 240A Debenture issuance programme**
- 241 Lodging supplementary document or replacement document
- 242 Stop order for prospectus and profile statement
- 243 Contents of prospectus
- 244
- 245 Retention of over-subscriptions and statement of asset-backing in debenture issues
- 246 Contents of profile statement
- 247 **Exemption** from requirements as to form or content of prospectus or profile statement
- 248 **Exemption** for certain governmental and international entities as regards signing of copy of prospectus or profile statement by all directors or equivalent persons
- 249 Expert's consent to issue of prospectus or profile statement containing statement by him
- 249A Consent of issue manager and underwriter to being named in prospectus or profile statement
- 250 Duration of validity of prospectus and profile statement
- 251 Restrictions on advertisements, etc.
- 252 Persons liable on prospectus or profile statement to inform person making offer about certain deficiencies
- 253 Criminal liability for false or misleading statements
- 254 Civil liability for false or misleading statements
- 255 Defences
- 256
- 257 Document containing offer of securities for sale deemed prospectus
- 258 Application and moneys to be held in trust in separate bank account until allotment
- 259 Allotment of securities where prospectus indicates application to list on securities exchange
- 260 Prohibition of allotment unless minimum subscription received

continued on next page

³ A full version of the *Securities and Futures Act (SFA)* can be found in Appendix 1.

Box 1.1 continuation

SUBDIVISION (3)—DEBENTURES

- 261 Preliminary provisions
- 262 Offer of asset-backed securities
- 263
- 264
- 265 Power of court in relation to certain irredeemable debentures

266 Duties of trustees

267 Powers of trustee to apply to court for directions, etc.

- 267A Right of Authority, securities exchange and holders of debentures to apply to court for order
- 268 Obligations of borrowing entity
- 269 Obligation of guarantor entity to furnish information
- 270 Loans and deposits to be immediately repayable on certain events

271 Liability of trustees for debenture holders

SUBDIVISION (4)—EXEMPTIONS

- 272 Issue or transfer of securities for no consideration

272A Small offers

272B Private placement

273 Offer made under certain circumstances

274 Offer made to institutional investors

275 Offer made to accredited investors and certain other persons

276 Offer of securities acquired pursuant to section 274 or 275

277 Offer made using offer information statement

278 Offer in respect of international debentures

- 279 Offer of debentures made by Government or international financial institutions
- 280 Making offer using automated teller machine or electronic means
- 281 Revocation of exemption
- 282 Transactions under exempted offers subject to Division 2 of Part XII of Companies Act and Part XII of this Act

DIVISION 1A—BUSINESS TRUSTS

SUBDIVISION (1)—INTERPRETATION

- 282A Preliminary provisions
- 282B Division not to apply to certain business trusts which are collective investment schemes
- 282BA Modification of provisions to certain offers

SUBDIVISION (2)—PROSPECTUS REQUIREMENTS

- 282C Requirement for prospectus and profile statement, where relevant
- 282D Lodging supplementary document or replacement document
- 282E Stop order for prospectus and profile statement
- 282F Contents of prospectus
- 282G Contents of profile statement
- 282H Exemption from requirements as to form or content of prospectus or profile statement
- 282I Expert's consent to issue of prospectus or profile statement containing statement by him
- 282J Consent of issue manager and underwriter to being named in prospectus or profile statement
- 282K Duration of validity of prospectus and profile statement
- 282L Restrictions on advertisements, etc.
- 282M Persons liable on prospectus or profile statement to inform person making offer about certain deficiencies
- 282N Criminal liability for false or misleading statements
- 282O Civil liability for false or misleading statements
- 282P Defences
- 282Q Document containing offer of units or derivatives of units for sale deemed prospectus
- 282R Application and moneys to be held in trust in separate bank account until allotment
- 282S Allotment of units or derivatives of units where prospectus indicates application to list on securities exchange
- 282T Prohibition of allotment unless minimum subscription received

continued on next page

Box 1.1 continuation

SUBDIVISION (3)—EXEMPTIONS

- 282U Issue or transfer of units or derivatives of units for no consideration
- 282V Small offers
- 282W Private placement
- 282X Offer made under certain circumstances
- 282Y Offer made to institutional investors
- 282Z Offer made to accredited investors and certain other persons
- 282ZA Offer of securities acquired pursuant to section 282Y or 282Z
- 282ZAA Offer of units converted from debentures
- 282ZB Offer made using offer information statement
- 282ZC Making offer using automated teller machine or electronic means
- 282ZD Revocation of exemption
- 282ZE Transactions under exempted offers subject to Division 2 of Part XII of Companies Act and Part XII of this Act

SUBDIVISION (4)—DEBENTURES

- 282ZF Applicability of provisions relating to prospectus requirements

DIVISION 2—COLLECTIVE INVESTMENT SCHEMES

SUBDIVISION (1)—INTERPRETATION

- 283 Interpretation of this Division
- 283A Use of term “real estate investment trust”
- 284 Code on Collective Investment Schemes
- 284A Authority may disapply this Division to certain offers and invitations
- 284B Division not to apply to certain collective investment schemes which are business trusts
- 284C Modification of provisions to certain offers

SUBDIVISION (2)—AUTHORISATION AND RECOGNITION

- 285 Requirement for authorisation or recognition
- 286 Authorised schemes
- 287 Recognised schemes
- 288 Revocation, suspension or withdrawal of authorisation or recognition
- 289 Approval of trustees**
- 290 Inspection of approved trustees**
- 291 Duty of trustees to furnish Authority with such return and information as Authority requires**
- 292 Liability of trustees**
- 293 Authority may issue directions
- 294 Service
- 295 Winding up
- 295A Power to acquire units of participants of real estate investment trust in certain circumstances
- 295B Unclaimed money to be paid to Official Receiver
- 295C Remedies in cases of oppression or injustice

SUBDIVISION (3)—PROSPECTUS REQUIREMENTS

- 296 Requirement for prospectus and profile statement, where relevant
- 297 Stop order for prospectus and profile statement
- 298 Lodging supplementary document or replacement document
- 299 Duration of validity of prospectus and profile statement
- 300 Restrictions on advertisements, etc.
- 301 Issue of units where prospectus indicates application to list on securities exchange
- 302 Application of provisions relating to securities

SUBDIVISION (4)—EXEMPTIONS

- 302A Issue or transfer for no consideration
- 302B Small offers**
- 302C Private placement**

continued on next page

Box 1.1 continuation

303 Offer or invitation made under certain circumstances
304 Offer made to institutional investors
304A First sale of units acquired pursuant to section 304
305 Offer made to accredited investors and certain other persons
305A First sale of units acquired pursuant to section 305
305B Offer made using offer information statement
 305C Making offer using automated teller machine or electronic means
 306 Power of Authority to exempt
 307 Revocation of exemption
 308 Transactions under exempted offers subject to Division 2 of Part XII of Companies Act and Part XII of this Act

DIVISION 3—SECURITIES HAWKING

309 Securities hawking prohibited

Note: Emphases added by author.

Source: Attorney-General's Chamber. <http://statutes.agc.gov.sg>

D. Definition of Relevant Person

A “relevant person” is defined under section 275(2) of the SFA to mean the following:

- (i) an “accredited investor”;⁴
- (ii) a corporation whose sole business is to hold investments and whose entire share capital is owned by one or more individuals, each of whom is an accredited investor;
- (iii) a trustee of a trust whose sole purpose is to hold investments, and each beneficiary of which is an individual who is an accredited investor;
- (iv) an officer or equivalent person of the person making the offer (such person being an entity), offeror (if it is an entity), or a spouse, parent, brother, sister, son or daughter of that officer, or equivalent person; or
- (v) a spouse, parent, brother, sister, son or daughter of that officer, or equivalent person, or of the person making the offer (if such person is an individual).

E. Definition of Accredited Investor, Expert Investor, and Institutional Investor

Section 4A of the SFA (Chapter 289) provides for the definitions for specific classes of investors.⁵

⁴ Section 4A of the SFA also provides for a more detailed definition of “accredited investor.” Also, see discussion in I.E.1.

⁵ Attorney-General's Chamber. 2006. *Securities and Futures Act*, Chapter 289 (SFA), as amended, sec. 4A: Specific Classes of Investors. http://statutes.agc.gov.sg/non_version/cgi-bin/cgi_retrieve.pl?actno=REVED-289&doctype=SECURITIES%20AND%20FUTURES%20ACT%0a&date=latest&method=part

1. Accredited Investor

An “accredited investor” is defined as:

- (i) an individual whose net personal assets exceed SGD2 million, or whose income in the preceding 12 months is not less than SGD300,000;
- (ii) a corporation with net assets exceeding SGD10 million in value as determined by the most recent audited balance sheet of the corporation, or where the corporation is not required to prepare an audited account regularly, a balance sheet of the corporation certified by the corporation as giving a true and fair view of the corporation’s state of affairs;
- (iii) the trustee of a trust; or
- (iv) such other person as the MAS may prescribe.

2. Expert Investor

An “expert investor” is defined as:

- (i) a person whose business involves the acquisition and disposal, or the holding, of capital markets products, whether as principal or agent;
- (ii) the trustee of a trust; or
- (iii) such other person as the MAS may prescribe.

3. Institutional Investor

An “institutional investor” is defined as:

- (i) a bank that is licensed under the *Banking Act*;
- (ii) a merchant bank approved as a financial institution under section 28 of the *Monetary Authority of Singapore Act*;
- (iii) a finance company licensed under the *Finance Companies Act*;
- (iv) a company or society registered under the *Insurance Act* as an insurer;
- (v) a company licensed under the *Trust Companies Act*;
- (vi) the government;
- (vii) a statutory body;
- (viii) a pension fund or collective investment scheme;
- (ix) the holder of a capital-markets services licence for dealing in securities, fund management, providing custodial services for securities, real estate investment trust management, securities financing, or trading in futures contracts;

- (x) a person (other than an individual) who carries on the business of dealing in bonds with accredited investors or expert investors;
- (xi) the trustee of a trust; or
- (xii) such other person as the MAS may prescribe.

F. Descriptions of Public Offering

1. General Explanation on Public Offering

Public offering is the selling of registered securities to the broad market rather than to a select group of investors. In Singapore, a public offer of bonds must be accompanied by a prospectus that is lodged with and registered by MAS, unless an exemption applies. The exemptions to the prospectus requirements include those for offers that are made only to institutional investors and accredited investors, and personal offers where the total amount raised within any 12-month period does not exceed USD5 million.⁶

Issuers of bonds that are offered to retail investors would normally seek a listing of these bonds on SGX, and the bonds are normally issued in small denominations.

Notices of bond offerings by statutory boards, domestic and foreign issuers are generally published in the newspapers or on the issuer's website. They outline issuance details such as auction dates, size and type of issue.

Bids are submitted through managing banks and the results—specifying the amount applied for, coupon rate, average yield and percentage allotted—are also publicly announced.

2. Offers and Prospectuses Electronic Repository and Access

General public offerings can be accessed through a prospectus database available in MAS' website under the Offers and Prospectuses Electronic Repository and Access (OPERA) tab. MAS launched OPERA in the context of making available more online services to market participants, as explained in the excerpt from the MAS Annual Report 2002/2003 in Box 1.2.

⁶ A detailed discussion on exemptions is found in I.H: Exemptions from Prospectus Requirements.

Box 1.2 Article on the Launch of the OPERA

July 2002
Launch of OPERA

MAS ANNUAL REPORT 2002 / 2003

ORGANISATIONAL INITIATIVES

INFORMATION TECHNOLOGY DEPARTMENT

New Era of Easy Access to E-services

Our move towards the disclosure-based regime took a big step forward in July 2002 with the launch of OPERA, the Offers and Prospectuses Electronic Repository and Access system.

OPERA gives the public easy access via the internet to prospectuses and offers of investments lodged to MAS as well as a feedback channel.

An online Minimum Liquid Assets (MLA) returns system was set up for banks.

Under the risk-based Liquidity Supervision Framework, banks with stronger liquidity risk management have lower MLA requirements. The new system gives banks a convenient and secure channel to submit MLA.

The MAS website was revamped to improve usability and accessibility. Content was reorganised and navigation flow improved. An enhanced integrated search engine gives the public easy access to information on the MAS, OPERA and Singapore Government Securities websites.

A link is being built from the MAS Electronic Payment System (MEPS) to the Continuous Linked Settlement System (CLS) to prepare for the inclusion of the Singapore Dollar as a CLS settlement currency. This link will greatly reduce the settlement risk for foreign exchange transactions involving the Singapore Dollar. Work has also begun on the next generation of the Real-Time Gross Settlement system. Based on SWIFT standards, this system will enable the industry to meet new commercial and regulatory challenges.

With the merger of BCCS with MAS, IT systems and network infrastructures were smoothly integrated. A high-speed link gives staff at Currency House access to all IT facilities at MAS Building. A knowledge management portal is being built to improve operational effectiveness and efficiency, and to create a culture of shared purpose and team collaboration. A group of pilot users are testing the system, which will include a strong search engine that provides the ability to quickly find relevant information and knowledge assets.

Source: Monetary Authority of Singapore. *MAS Annual Report 2002/2003*. Singapore. http://www.mas.gov.sg/about_us/annual_reports/annual20022003/f_organisational/organisational_f.html

OPERA is available for viewing of all relevant offer information everyday including Sundays, with the exception of its daily scheduled downtime between 4am and 7:30am Singapore Time (GMT+8).⁷

3. Prospectus Registration Process

A prospectus can consist of a base prospectus (valid for 2 years) and a pricing statement. The base prospectus is valid for all offers under the same program, and subsequent offers require only that a pricing statement be lodged and registered with the MAS.

A preliminary prospectus may be distributed to institutional and accredited investors only, to determine the appropriate amount and price of the securities to be offered, even before registration of the prospectus itself. Upon lodgment of the prospectus, the

⁷ Monetary Authority of Singapore. <http://masnet.mas.gov.sg/opera/sdrprosp.nsf>

issuer can conduct roadshow presentations to institutional and accredited investors, as well as commence book-building exercises. After lodgment, the prospectus is put up for public viewing and comment on the MAS website's OPERA portal.

A regulatory review is conducted by the MAS. The MAS will register the prospectus within 14 to 21 days, unless the period is extended for a maximum of 28 days, or the issuer requests a later registration date. The issuer can then launch the public offer and distribute the registered prospectus after registration.

The timeline of the registration process for a prospectus is further illustrated in Figure 1.1. for easy reference.

Figure 1.1 Timeline of Registration Process

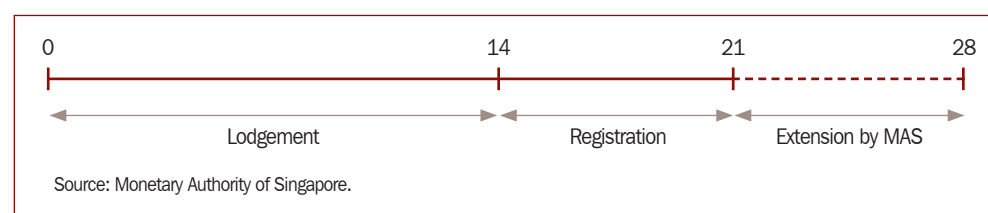

G. Provisions on Private Placement

Private placement (PP), or non-public offering, is the selling of unregistered securities directly, where an offer is made to not more than 50 investors within a 12-month period. Private bond placements sometimes are not listed on a stock exchange. An issuer who offered the bonds through private placement can still seek a listing on SGX.

Many primary issuances are made in the form of PP offers. Many Singapore dollar corporate bonds are placed privately at the issuer's or investor's (reverse enquiry) initiative.⁸

The SFA contains a number of specific provisions for Private Placement which are detailed in Box 1.3 for easy reference.

⁸ Government of Singapore. Monetary Authority of Singapore. 2007. *Singapore Bond Market Guide*. http://www.sgs.gov.sg/resource/pub_guide/guides/Bond_Market_Guide_Mar_2007.pdf

Box 1.3 Provisions on Private Placement in the Securities and Futures Act**Private placement:**

272B.—(1) Subdivisions (2: Prospectus requirements) and (3: DEBENTURES) of this Division (1: Shares and Debentures) (other than section 257) shall not apply to offers of securities of an entity that are made by a person if—

- (a) the offers are made to no more than 50 persons within any period of 12 months;
- (b) none of the offers is accompanied by an advertisement making an offer or calling attention to the offer or intended offer;
- (c) no selling or promotional expenses are paid or incurred in connection with each offer other than those incurred for administrative or professional services, or by way of commission or fee for services rendered by—
 - (i) the holder of a capital markets services licence to deal in securities;
 - (ii) an exempt person in respect of dealing in securities; or
 - (iii) a person who is licensed, approved, authorised or otherwise regulated under the laws, codes or other requirements of any foreign jurisdiction in respect of dealing in securities, or who is exempted therefrom in respect of such dealing; and

(d) no prospectus in respect of any of the offers has been registered by the Authority or, where a prospectus has been registered—

- (i) the prospectus has expired pursuant to section 250; or
- (ii) the person making the offer has before making the offer—

(A) informed the Authority by notice in writing of its intent to make the offer in reliance on the exemption under this subsection; and

(B) taken reasonable steps to inform in writing the person to whom the offer is made that the offer is made in reliance on the exemption under this subsection.

(2) The Authority may prescribe such other number of persons in substitution for the number specified in subsection (1) (a).
[1/2005]

(3) In determining whether offers of securities by a person are made to no more than the applicable number of persons specified in subsection (1) (a) within a period of 12 months, each person to whom—

- (a) an offer of securities issued by the same entity is made by the first-mentioned person; or
- (b) an offer of securities of an entity, units or derivatives of units in a business trust, or units in a collective investment scheme, is made by the first-mentioned person or another person where such offer is a closely related offer,

if any, within that period in reliance on the exemption under this section, section 282W or 302C shall be included.
[1/2005]

(4) Whether an offer is a closely related offer under subsection (3) shall be determined by considering such factors as the Authority may prescribe.
[1/2005]

(5) For the purposes of subsection (1)—

- (a) an offer of securities to an entity or to a trustee shall be treated as an offer to a single person, provided that the entity or trust is not formed primarily for the purpose of acquiring the securities which are the subject of the offer;
- (b) an offer of securities to an entity or to a trustee shall be treated as an offer to the equity owners, partners or members of that entity, or to the beneficiaries of the trust, as the case may be, if the entity or trust is formed primarily for the purpose of acquiring the securities which are the subject of the offer;
- (c) an offer of securities to 2 or more persons who will own the securities acquired as joint owners shall be treated as an offer to a single person;
- (d) an offer of securities to a person acting on behalf of another person (whether as an agent or otherwise) shall be treated as an offer made to that other person;

Box 1.3 continuation

- (e) offers of securities made by a person as an agent of another person shall be treated as offers made by that other person;
- (f) where an offer is made to a person with a view to another person acquiring an interest in those securities by virtue of section 4, only the second-mentioned person shall be counted for the purposes of determining whether offers of the securities are made to no more than the applicable number of persons specified in subsection (1) (a); and
- (g) where—
 - (i) an offer of securities is made to a person in reliance on the exemption under subsection (1) with a view to those securities being subsequently offered for sale to another person; and
 - (ii) that subsequent offer—
 - (A) is not made in reliance on an exemption under any provision of this Subdivision; or
 - (B) is made in reliance on an exemption under subsection (1) or section 280, both persons shall be counted for the purposes of determining whether offers of the securities are made to no more than the applicable number of persons specified in subsection (1) (a). [1/2005]
- (6) In subsection (1) (b), “advertisement” has the same meaning as in section 272A (10).

Note: Similarly, private placements are stipulated in sec. 282W and 302C of SFA.

Source: Attorney-General’s Chamber. *Securities and Futures Act*, sec. 272B. http://statutes.agc.gov.sg/non_version/cgi-bin/cgi_retrieve.pl?actno=REVED-289

H. Brief Summary of Exemptions from Prospectus Requirements

As previously mentioned, a number of exemptions from prospectus requirements exist, particularly for the specific categories of investors detailed in I.E. These exemptions can be summarized as:

- a. Offers made to institutional investors or accredited investors, and need to be accompanied by public advertisements.⁹
- b. Private placement offers made to no more than 50 persons.¹⁰
- c. An entity whose shares are already listed on the SGX may use an Offer Information Statement (OIS), instead of a prospectus, when issuing new types of securities such as bonds. An OIS has fewer disclosure requirements.
- d. Institutions offering continuously issued structured notes do not need to lodge and register a pricing statement with the MAS; the base prospectus, a transaction note setting out the offer details prior to the purchase or subscription, and a confirmation receipt to the investors at the time of offer, are sufficient.
- e. Small Offer: the total amount raised by the person from such offers within any period of 12 months does not exceed SGD5 million, or its equivalent in a foreign currency.¹¹

⁹ Footnote 5, sec. 274 and 275.

¹⁰ Footnote 5, sec. 272B.

¹¹ Footnote 5, sec. 272.

These exemptions can also be found in the “2007 Singapore Bond Market Guide”.¹²

I. Overview of the Singapore Exchange Bond Listing Criteria

1. Criteria for Listing: A General Guide for Bonds

For primary listing, companies must meet SGX’s initial listing requirements outlined in Table 1.2. After listing, companies have to comply with all of SGX’s continuing listing obligations. For secondary listing, companies already listed on another exchange of equivalent rules as SGX are able to seek secondary listing on SGX without having to comply with SGX’s continuing listing obligations.

2. Mainboard Requirements

A company may list on the mainboard under any of the three criteria below, which cater to a wide spectrum of companies with different business models.

Table 1.2 Criteria for Listing

	Criteria 1	Criteria 2	Criteria 3
Pre-Tax Profits	Cumulative pre-tax profit of at least USD7.5 million over the last 3 consecutive years, with a pre-tax profit of at least USD1 million in each of those 3 years	Cumulative pre-tax profit of at least USD10 million for the last 1 or 2 years	NA
Market Capitalisation	NA	NA	Market capitalisation of at least USD80 million at the time of the initial public offering, based on the issue price
Shareholding Spread	25% of issued shares in the hands of at least 1,000 shareholders (For market capitalisation > SGD300 million, shareholding spread will vary between 12%–20%). There should at least be 2,000 shareholders worldwide in the case of a secondary listing.		
Operating Track Record	3 years	NA	NA
Continuity of Management	3 years	1 or 2 years as the case may be	NA
Accounting Standard	Singapore, US or International Accounting Standards		
Continuing Listing Obligations	Yes	Yes	Yes
	Waived from having to comply with continuing listing obligations if listed on another recognized foreign stock exchange.		
Domicile	At the discretion of the issuer		
Trading and Reporting Currency	At the discretion of the issuer		
Business Operations	No requirement for operations in Singapore		
Independent Directors	At least 2 residents in Singapore		
Note: NA = not applicable Source: Singapore Exchange. http://www.sgx.com/wps/portal/sgxweb/home/listings/listing_products/!ut/p/c5/DcrrddolgAADgZ9kD71DMCi8xzuYfeMotiZuOaFHBYM5M590v891-QIAn2zyuqrlfnW0MqIBYH7Mc-hHyYODf-AbGUbpPimlbpoeEHEiCuf5S1pPKzrsFCX0rifEqHHEImOcjPF74S3b23BbD0r1R2mZaNYa6YBM1NpJ-q3bV-T-uuutVhOBprv7ghfGyj3IX2RkLQzvMDqw7Jjz32JP2MKF51JqEDsVjDuWS9PNXuqDQICb_9DcyIFVd97_sBfDifZ_Aj5bTP7hCuE8!/dl3/d3/LOIDU0IKSWdra0EhIS9JIJBUipQ2dBek15cUEhL1ICSIAxTkMxTktfMjd3ISEvN19MTzA0SDI0MDkwM043MEIIS1JKU1NDQktENg!/?WCM_PORTLET=PC_7_LO04H240903N70IHKRJSSCBK6017268_WCM&WCM_GLOBAL_CONTEXT=/wps/wcm/connect/sgx_en/home/listing_on_sgx/overview/			

J. General Guide for Singapore Exchange Bond-Listing Requirements

Listing requirements for bonds are set out in the chapter on debt securities of the “Main Board Rules” in the *SGX Rulebook*.¹³ Prospective issuers must fulfill the stated requirements before they are eligible to issue bonds.

¹² Footnote 8.

¹³ Singapore Exchange Securities Trading, *Singapore Exchange Rulebook*, chapter 3, “Debt Securities.” http://rulebook.sgx.com/en/display/display_main.html?rbid=3271&element_id=4949

Additional listing requirements for retail fixed-income securities are set out in the chapter on prospectus, offering memorandum, and introductory document of the SGX “Main Board Rules.”¹⁴ Prospective issuers must fulfill the stated requirements before they are eligible to issue retail fixed income securities.

The SGX Rulebook likewise provides for the general requirements for debt securities listing. These include:¹⁵

1. **Paying Agent.** A foreign issuer is normally required to appoint a paying agent in Singapore or in the Central Depository (Pte.) while the debt securities are quoted on the exchange and upon the issue of debt securities in definitive form. The exchange may accept other arrangements to enable definitive certificate holders of the bearer debt securities in Singapore to be paid promptly.
2. **Appointment of Trustee and Trust Deed and Exempt Issue.** An issuer must appoint a suitable trustee to represent the holders of its debt securities listed on the exchange. However, a trustee is not required for a debt issue that is offered only to sophisticated investors or institutional investors and is traded in a minimum board lot size of SGD200,000 or its equivalent in foreign currencies following listing.¹⁶
3. **Content of Offering Memorandum or Introductory Document (Prospectus Exempt).** For debt securities issued by an entity whose equity securities are listed on SGX, or debt securities offered primarily to sophisticated investors or institutional investors, a prospectus is not required. Instead, an offering memorandum or introductory document containing the information that investors would customarily expect to see in such documents would suffice.
4. **Continuing Obligations.** In general, a debt issuer must immediately disclose to the exchange through SGXNet any information which may have a material effect on the price or value of its debt securities or on an investor’s decision whether to trade in such debt securities.¹⁷

K. Summary of Listing Criteria of Foreign Debt Securities on the Singapore Exchange

1. Listing Criteria

One of the following listing criteria must be met for the listing of foreign debt securities:

¹⁴ Footnote 13, chapter 6, “Prospectus, Offering Memorandum and Introductory Document.” http://rulebook.sgx.com/en/display/display_main.html?rbid=3271&element_id=5034

¹⁵ Singapore Exchange Securities Trading, *Singapore Exchange Rulebook*. http://rulebook.sgx.com/en/display/display_viewall.html?rbid=3271&element_id=4953

¹⁶ Refer to art. 308, part IV (Trustee and Trust Deed) of chapter 3 (Debt Securities) of the SGX “Main Board Rules” for detailed information on the suitability of the trustee and the provisions to be included in the trust deed.

¹⁷ Refer to art. 316, part VI (Continuing Listing Obligations) of chapter 3 (Debt Securities) of the SGX “Main Board Rules” for more detailed information on continuing disclosures.

- (i) The issuer must be:
 - (a) a supranational body;
 - (b) a government, or a government agency whose obligations are guaranteed by a government;
 - (c) an entity whose equity securities are listed on the SGX;
 - (d) a corporation which meets the following requirements:
 - (d.1) Rules 210 (2), (3), (4), and (5) of the *SGX Listing Rules* for listing of equity securities; or
 - (d.2.1) a cumulative consolidated pre-tax profit of at least SGD50 million for the last 3 years, or a minimum pre-tax profit of SGD20 million for any one of those 3 years; and
 - (d.2.2) a consolidated net tangible assets of at least SGD50 million; or
 - (e) a corporation whose obligations under the issue of the bonds are guaranteed by any of the entities in (a), (b), (c) or (d) above;
- (ii) The issue of the bonds must be at least 80% subscribed by institutional investors and/or sophisticated investors; or
- (iii) The issue of the bonds must have a credit rating of investment grade and above.

2. Other Requirements

While the *SGX Rulebook* stipulates certain trust deed and report releasing requirements, these requirements will not be applicable to:

- (i) An issuer who has been declared a “prescribed corporation” for the purpose of section 239(4) of the SFA; or
- (ii) (a) an issue of bonds that is offered only to institutional investors and/or sophisticated investors; and
 - (b) bonds are traded in a minimum board lot size of SGD200,000 or its equivalent in foreign currencies following listing.

In connection with the listing of bonds on the exchange, the other principal requirement under the Listing Rules is that the issuer would be required to appoint a paying agent in Singapore upon the issue of the bonds in definitive form.

3. Content of Offering Document

- 3.1 Where the offering of the bonds is made primarily to institutional investors and/or sophisticated investors, there is a general disclosure requirement that the offering memorandum or introductory document must contain the information

that such investors would customarily expect to see in such documents. Apart from the above general requirement, there are no specific disclosure requirements, whether relating to the financial information of the issuer or otherwise, set out in the SGX Listing Rules for such an offering.

3.2 While “institutional investors” and “sophisticated investors” are not specifically defined in the SGX Listing Rules, a general understanding is that the exchange would generally construe “institutional investors” and “sophisticated investors” to mean:

- (i) persons as specified under section 274 and 275 of the SFA, in relation to investors in Singapore; and
- (ii) such equivalent terms in the relevant jurisdictions outside Singapore where the bonds are offered, in relation to investors outside Singapore.

3.3 Section 274 of the SFA provides that the prospectus requirements of the SFA shall not apply to an offer of securities made to institutional investors.

3.4 Section 275 of the SFA provides that the prospectus requirements of the SFA shall not apply to an offer of bonds to a relevant person.

- (a) Section 275(1) provides that the prospectus requirements shall not apply to an offer of securities to a person who acquires the bonds as principal, if:
 - (i) the offer is on terms that the bonds may only be acquired at a consideration of not less than SGD200,000 (or its equivalent in foreign currencies) for each transaction, whether such amount is to be paid in cash or by exchange of securities or other assets;
 - (ii) the offer is not accompanied by an advertisement making an offer or calling attention to the offer;
 - (iii) no selling or promotional expenses are paid or incurred in connection with the offer other than those incurred for administrative or professional services; and
 - (iv) no prospectus in respect of the offer has been registered by MAS.

L. General Listing Procedures

The general procedure for the listing of debt securities on SGX is illustrated in Figure 1.2 and followed by a more detailed description of the individual steps thereafter.

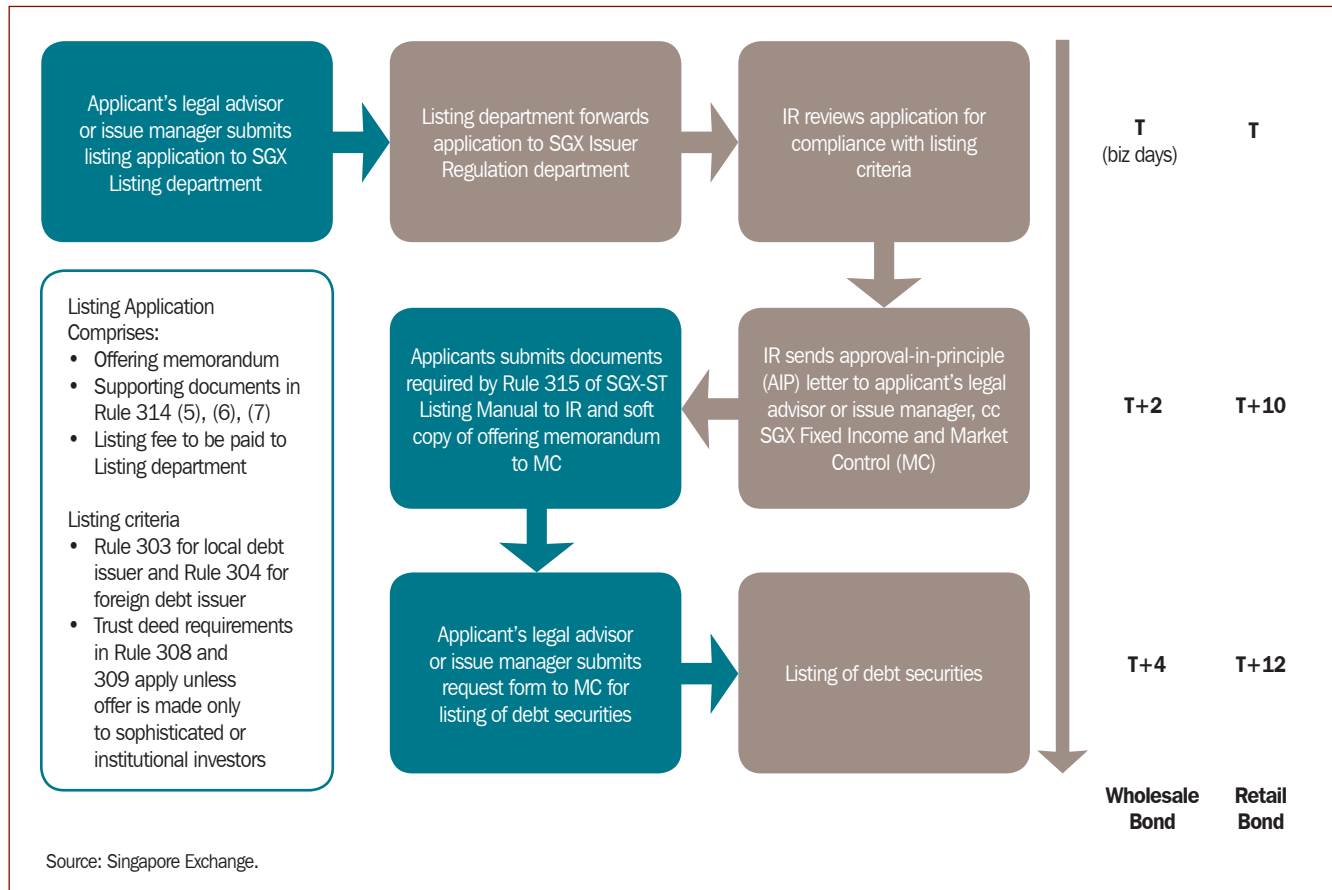
Figure 1.2 General Listing Procedure

1. A listing application, comprising the final form of the prospectus, offering memorandum, or introductory document prepared in compliance with Rules 312 to 313 and supporting documents set out in Rule 314, is to be submitted to the Listings Function of the SGX.
2. Upon satisfaction of the listing requirements set out in the application, the SGX will issue an eligibility-to-list letter for listing, with or without conditions.
3. More information on listing requirements can be obtained from the SGX Listing Rules, available online at www.sgx.com.
4. The issuer will lodge the prospectus, offering memorandum, or introductory document with the MAS and other relevant authorities, if applicable, and will submit a copy to the SGX.
5. Should the prospectus, offering memorandum, or introductory document be materially different from that on which the eligibility-to-list letter was issued, the issuer must submit a written confirmation to the SGX to this effect.

6. The SGX will inform the issuer of any further information that is required to be disclosed prior to commencement of trading. The issuer may include this information in its prospectus, offering memorandum, or introductory document, or to make a pre-quotations disclosure through an announcement to the SGX. The pre-quotations disclosure must be made no later than the market day before commencement of trading.
7. The issuer's debt security will be listed and quoted on the SGX after the conditions expressed in the eligibility-to-list letter are satisfied.

M. Reference for Singapore Government Securities Listing

SGX commenced the listing of SGS on 8 July 2012, initially selecting 19 SGS issues with maturities of at least 2 years and the farthest maturity on 1 September 2030.

There is no listing requirement for SGS since they are issued by the government.¹⁸

N. Singapore Exchange Rulebook on Debt Securities

The SGX Rulebook details the "Main Board Rules" with its third chapter devoted to provisions on debt securities.¹⁹ Please see Appendix 2 for Chapter 3 of the SGX Rulebook.

O. Placement of Bonds in the Primary Market

Primary issuance can be in the form of a public offering or a private placement. Public offering is the selling of registered securities to the broad market, rather than to a select group of investors. Public bond offerings are usually listed on a stock exchange in relatively small denominations, and a prospectus is required to be lodged.

A private placement, on the other hand, is the selling of unregistered securities directly, where offer is made to not more than 50 investors within a 12-month period. Private bond placements are not listed on a stock exchange, do not require a prospectus, and consequently cost less than a public offering.

Medium-term note (MTN) programs and reverse enquiries are quite common in the Singapore debt market. MTNs can be offered continuously through agents or dealers on a best effort rather than on an underwritten basis, allowing issuers to meet investors' demand as it emerges.

There are three types of methods available for primary market placement:

- (i) public issue;

¹⁸ Singapore Exchange Securities Trading, *Singapore Exchange Rulebook*. http://rulebook.sgx.com/en/display/display_viewall.html?rbid=3271&element_id=4953

¹⁹ Footnote 14.

- (ii) private placement; and
- (iii) continuous placement.

Licensed securities dealers and exempt dealers (e.g., banks and merchant banks) are permitted to engage in primary market transactions as agents of the issuer. Every public offering of securities requires a prospectus for offering unless it qualifies for one of the legally defined exemptions. Whenever such exemption is applicable, an information memorandum or a statement of material facts is to be issued. All issue managers are required to comply with the requirements in the laws and regulations (e.g., *Banking Act*, *Securities and Futures Act*, and *Companies Act*, and their corresponding regulations).

The most common issuance method for bonds in the Singapore market is via auction. Singapore government securities are issued via auctions conducted by MAS. Underwriters for corporate bonds may conduct bookbuilding exercises for their issuers. Some of the salient auction information is provided in Table 1.3.

Table 1.3 Auction Information

	SGS Bills	SGS Bonds	Corporate Bonds
Auction Technique	Uniform Pricing (with competitive or noncompetitive bidding)	Uniform Pricing (with competitive or noncompetitive bidding)	Private placement or public offering with appointed financial institutions
Auction Frequency	Weekly for 3-month T-bills; twice a year for 1-year T-bills	Depends on issuance calendar	NA
Typical Issue Size	SGD2.3 billion–SGD4.0 billion	SGD2 billion–SGD3 billion for benchmark issues	

NA = not applicable
Source: Monetary Authority of Singapore.

P. Secondary Market Trading

SGS primary dealers also participate in the secondary bond market, including the trading of corporate bonds through their respective group entities with an SGX trading seat, as may be applicable.

Table 1.4 provides an overview of some of the more general trading and settlement parameters of the different secondary bond market segments.

Table 1.4 Secondary Market Information

Items	SGS Bills	SGS Bonds	Corporate Bonds
Trading	OTC / SGX	OTC / SGX	OTC
Settlement (via)	MEPS+ on DvP basis. CDP cuts off at 3:00 p.m.	MEPS+ on DvP basis. CDP cuts off at 3:00 p.m.	CDP
Regular Trades			
Trading Hours	9:00 a.m. to 4:30 p.m. (Monday to Friday)	9:00 a.m. to 4:30 p.m. (Monday to Friday)	Not fixed
Settlement Period	T+1 The market has T+0 transactions agreed upon quite commonly.	T+1 The market has T+0 transactions agreed upon quite commonly.	T+3

CDP = Central Depository Pte.; DVP = delivery versus payment; MEPS+ = Monetary Authority of Singapore (MAS) Electronic Payment System; OTC = over the counter; SGX = Singapore Exchange; T = time
Source: Monetary Authority of Singapore

Q. Methods of Issuing Bonds

1. Methods of Issuing Government Bonds

SGS are issued in the primary market through auction according to a pre-announced issuance calendar in the MAS website. Three-month T-bills are issued weekly, while 1-year T-bills and bonds are issued according to an annual issuance calendar. All applications for SGS allocations must be submitted through any of the approved SGS primary dealers. SGS primary dealers will then apply for the book-entry SGS on offer at primary auctions by way of the SGS electronic applications service (SGS eApps) available on the SGS website.

Details of the auction conduct for both Treasury bills and SGS bonds are described in Table 1.5 below.

Table 1.5 Auction Conduct

	T-bills	Bonds
Auction Format	Uniform pricing. Successful competitive and non-competitive bids will be allotted at a uniform yield, which is the highest accepted yield (also referred to as cut-off yield) of successful competitive bids submitted at the auction.	
Bids	In yield terms	
Admission	All entities or individuals; non-residents are admitted ^a	
Central bank participation	Yes, but only on a non-competitive basis; MAS' intended amount, if any, is pre-announced to the market prior to each auction	
Competitive bids		
Maximum number of bids	Unconstrained	
Maximum allotment ^b		
- Primary dealer	30% of issue on offer per applicant	
- Non-primary dealer	15% of issue on offer per applicant	
Non-competitive bids		
Status	Total non-competitive allotment is subject to a limit of 40% of issue on offer, with pro-rated allocation if application exceeds this limit	
Maximum allotment		
- Primary dealer	1% of issue on offer per applicant	
- Non-primary dealer	SGD2 million per application for bonds; SGD1 million per application for T-bills	
Auction Process	For both bonds and T-bills, non-competitive bids will be allotted first. The balance of the issue amount will be subsequently awarded to competitive tenders from the lowest to highest yields.	
Auction results		
Lag between:		
1. Announcement and auction	About 5 business days for bonds; About 3 business days for T-bills	
2. Bids and results	About 1 hour	
3. Results and settlement	About 3 business days	
Published information	Average and cut-off prices; percentage of applications at cut-off allotted, total amount of securities applied for and allotted.	
Other information		
Accounting	Book-entry	
Primary Dealers	13	
Underwriters	Yes; Each primary dealer is obligated to tender for an equal share of the issue on offer	
Post-auction subscription	No	
Frequency of auctions	Weekly for 3-month T-bills; twice a year for 1-year T-bills; Annually or semi-annually for bonds according to a published issuance calendar that is consistent and transparent	
Cut-off Time	All bids need to be submitted by noon on the auction day.	
When-issued trading	Yes	

^a Individual investors will be required to custodise their SGS with the Central Depository (CDP).

^b The maximum auction allocation limits of 30% and 15% of the issue on offer for each Primary Dealer and non-primary dealers, respectively, include the amounts of non-competitive bids. Source: Singapore Government Securities. http://www.sgs.gov.sg/market_characteristics/mktchar_auctions.html

2. Methods of Issuing Corporate Bonds

a. Corporate Bonds

The Monetary Authority of Singapore (MAS) requires corporate issuers to file a prospectus and follow procedures outlined in the *Securities and Futures Act of 2001* (SFA). For corporate bonds that have been or will be offered through the securities exchange, SGX, a copy of the prospectus and a credit rating, if applicable, must be lodged and registered with MAS. Private placements, and the issue to specific groups of investors, are typical for corporate bonds in Singapore, and may qualify for exemptions from said prospectus requirements.

b. Corporate Bonds Issued by Foreign Entities

There are no capital and exchange restrictions in Singapore. Non-residents are free to issue Singapore dollar-denominated securities, to buy and sell Singapore dollars, and to carry out hedging transactions. The sole restriction is that non-resident financial institutions are required to swap or convert their Singapore dollar proceeds into foreign currencies when they repatriate it out of Singapore. In such cases, MAS requires that the swap duration matches the tenor of the bond.

Prospectus requirements for issuing bonds in Singapore have been streamlined. Financial statements to be provided in the prospectus for listed debentures can be prepared in accordance with the Financial Reporting Standards (FRS), International Financial Reporting Standards (IFRS), or the US Generally Accepted Accounting Principles (US GAAP). For financial statements prepared using other accounting standards, these must be restated in accordance with one of the acceptable standards, and accompanied by an auditor's opinion that no material adjustments are required.

R. Credit Rating Agencies and the Credit Rating of Bonds

Singapore does not have any homegrown credit rating agencies, but instead relies on international rating services. As a foreign debt securities listing requirement of SGX, any issue of debt securities must have a credit rating of investment grade and above. The same requirement applies for the listing of local debt securities, with the additional requirement that for the issuer qualifying under the listing requirements, any issue of debt securities must have a principal amount of at least SGD750,000.

Under the *Securities and Futures Regulations 2005* (SFR), specifically the provisions on “Offers of Investments” and “Shares and Debentures”, where the issuer or the bonds being offered have been given a credit rating by a credit rating agency, the following should be disclosed in the prospectus:

- (i) Name of the credit rating agency;
- (ii) The credit rating, including whether it is a short-term or long-term credit rating;
- (iii) Whether or not the relevant entity, its guarantor entity, or any of their related parties had paid any fee or benefit of any kind to the credit rating agency in consideration for the credit rating; and

(iv) The date on which the credit rating was given.

S. Bond Related Systems for Investor Protection

1. Overview

There is no investor protection fund in Singapore. This is mainly due to the fact that there are no investment restrictions on securities listed on the SGX. However, CDP, which is the depository and clearing agent for transactions done on the SGX, maintains a compensation fund.

2. Introduction of the Electronic Disclosure System

To enhance price transparency and improve investor access to trading activity in Singapore government bonds and bills, MAS launched the E-Bond platform for SGS in July 2005. The platform, through the Bloomberg Professional Service, allows global investors easy access to real-time trading volume and price quotations by SGS primary dealers. It is a straight-through-processing (STP) electronic trading platform for SGS bonds and Treasury bills. It offers SGS primary dealers a multi-dealer requests-for-quote feature, as well as a quote-driven electronic order book for price providers to leave their bids and offers. By publishing pre-trade prices, the platform boosts investor confidence by promoting more efficient price discovery, and helps attract more issuers and investors to participate in the Singapore dollar bond market as well as improve resilience of the market in times of stress.

From 8 July 2011, individual investors were able to trade SGS bonds in the secondary market on the Singapore Exchange. Market makers, who are also SGS primary dealers, have committed to provide two-way prices for the SGS bonds traded on the Exchange. With the new offering by SGX, investors were able to access SGS bond prices on SGX's website or through their brokers, and trade SGS bonds through their brokers in a manner similar to the way stocks are traded. Trading of SGS and corporate bonds for the institutional market remains over-the-counter (OTC).

A total of 20 SGS bonds amounting to SGD82.3 billion are currently traded on the SGX, with maturities of 2 years or more. SGX's Central Depository (Pte.) Limited (CDP) acts as the custodian of SGS bonds traded on the exchange.

Singapore features a fiduciary concept for the principal protection of investors in fixed income securities. The role of a trustee follows the legal tradition under English law, and is performed by designated trustee companies.

The Securities and Futures Act 2001 stipulates the need for an issuer to appoint a trustee to represent the interests of the bondholders of a given bond issue; however, this requirement is subject to a number of exemptions.

The details of the trustee concept and the relevant exemptions are contained in the next Chapter U.

T. Trustee System

An issuer must appoint a suitable trustee to represent the holders of its debt securities listed on the SGX. However, a trustee is not required for a debt issue that is offered only to sophisticated or institutional investors and traded in a minimum board lot size of SGD200,000, or its equivalent in foreign currencies following the listing.²⁰

The duties of trustees are stipulated in Part XIII of the SFA as illustrated in Box 1-4.

Box 1.4 Duties of Trustees

PART XIII: Securities and Futures Act (SFA)
OFFERS OF INVESTMENTS
Division 1 — Shares and Debentures
SUBDIVISION (3) — DEBENTURES

Duties of trustees

266. —(1) (Deleted by Act 16/2003)

(2) Where, after due inquiry, the trustee for the holders of debentures at any time is of the opinion that the assets of the borrowing entity and of any of its guarantor entities which are or should be available whether by way of security or otherwise, are insufficient, or likely to become insufficient, to discharge the principal debt as and when it becomes due, the trustee may apply to the Authority for an order under this subsection.

[1/2005]

(3) The Authority, on such application —

(a) after giving the borrowing entity an opportunity of making representations in relation to that application, by order in writing served on the entity at its registered office in Singapore, may impose such restrictions on the activities of the borrowing entity, including restrictions on advertising for deposits or loans and on borrowing by the entity as the Authority thinks necessary for the protection of the interests of the holders of the debentures; or

(b) may, and if the borrowing entity so requires, shall direct the trustee to apply to the court for an order under subsection (5); and the trustee shall apply accordingly.

[1/2005]

(4) Where —

(a) after due inquiry, the trustee at any time is of the opinion that the assets of the borrowing entity and of any of its guarantor entities which are or should be available, whether by way of security or otherwise, are insufficient or likely to become insufficient, to discharge the principal debt as and when it becomes due; or

(b) the borrowing entity has contravened an order made by the Authority under subsection (2), the trustee may, and where the borrowing entity has requested the trustee to do so, shall apply to the court for an order under subsection (5).

[1/2005]

(5) Where an application is made to the court under subsection (3) or (4), the court may, after giving the borrowing entity an opportunity to be heard, by order, do all or any of the following things:

(a) direct the trustee to convene a meeting of the holders of the debentures for the purpose of placing before them such information relating to their interests and such proposals for the protection of their interests as the trustee considers necessary or appropriate, and of obtaining their directions in relation thereto and give such directions in relation to the conduct of the meeting as the court thinks fit;

(b) stay all or any actions or proceedings before any court by or against the borrowing entity;

(c) restrain the payment of any moneys by the borrowing entity to the holders of debentures of the borrowing entity or to any class of such holders;

(d) appoint a receiver of such of the property as constitutes the security, if any, for the debentures;

(e) give such further directions from time to time as may be necessary to protect the interests of the holders of the debentures, the members of the borrowing entity or any of its guarantor entities or the public,

but in making any such order the court shall have regard to the rights of all creditors of the borrowing entity.

[1/2005]

(6) The court may vary or rescind any order made under subsection (5) as the court thinks fit.

continued on next page

²⁰ Footnote 19.

Box 1.4 continuation

(7) A trustee in making any application to the Authority or to the court shall have regard to the nature and kind of the security given when the offer of the debentures was made, and if no security was given shall have regard to the position of the holders of the debentures as unsecured creditors of the borrowing entity.

[1/2005]

(8) A trustee may rely upon any certificate or report given or statement made by any advocate and solicitor, auditor or officer of the borrowing entity or guarantor entity if it has reasonable grounds for believing that such advocate and solicitor, auditor or officer was competent to give or make the certificate, report or statement.

[1/2005]

[Companies, s. 101]

Powers of trustee to apply to court for directions, etc.

267. —(1) A trustee for the holders of debentures may apply to the court —

- (a) for directions in relation to any matter arising in connection with the performance of the functions of the trustee; or
- (b) to determine any question in relation to the interests of the holders of debentures.

(2) The court may —

- (a) give such directions to the trustee as the court thinks fit; and
- (b) if satisfied that the determination of the question will be just and beneficial, accede wholly or partially to any such application on such terms and conditions as the court thinks fit or make such other order on the application as the court thinks just.

(3) The court may, on an application under this section, order a meeting of all or any of the holders of debentures to be called to consider any matters in which they are concerned and to advise the trustee on those matters and may give such ancillary or consequential directions as the court thinks fit.

(4) The meeting shall be held and conducted in such manner as the court directs, under the chairmanship of a person nominated by the trustee or such other person as the meeting appoints.

[Companies, s. 102]

Note: Emphases added by author.
Source: Attorney-General's Chamber.

U. Governing Laws on Bond Issuance

Several acts of parliament provide the legal framework for the Singapore securities market:

1. Companies Act (Cap 50)

All companies in Singapore are governed by the *Singapore Companies Act* (Cap 50 of the 1994 Revised Edition of the Singapore Statutes). The act provides for the formation (and ultimately termination) of companies; confers on companies some special features; and regulates the relationships between participants in companies and facilitates dealings between companies and outsiders. A summary of recent amendments to the act can be found in the website of Janus Corporate Solutions.²¹

2. Securities and Futures Act 2001 (Cap 289)

The SFA was first passed by parliament on 5 October 2001. Since then, it has been coming into force in parts. Part I (“Preliminary”), Part VIII (“Securities Industry Council and Take-over Offers”), Part IX (“Supervision and Investigation”), Part X (“Assistance to Foreign Regulatory Authorities”), and Part XV (“Miscellaneous,” except sections 314, 342[1] and [3]) came into effect on 1 January 2002. MAS announced on 23 May

²¹ JanusCorporateSolutions.<http://www.guidemesingapore.com/incorporation/topics/singapore-companies-act-recent-amendments>

2002 that Part XIII of the SFA would come into force on 1 July 2002. This part deals with offers of shares, debentures, and collective investment schemes.

In tandem with the announcement of the date of enforcement of Part XIII of the SFA, MAS also issued new regulations to supplement it, the main regulations of which are:

- (i) The *Securities and Futures (Offers of Investments) (Shares and Debentures) Regulations 2002* (Shares and Debentures Regulations); and
- (ii) The *Securities and Futures (Offers of Investments) (Collective Investment Schemes) Regulations 2002* (Collective Investment Schemes Regulations).

These regulations also came into force on 1 July 2002.

3. *Monetary Authority of Singapore Act (Cap 186)*

The act was passed to establish a corporation to be known as the Monetary Authority of Singapore (MAS). It also provides for the transfer to the corporation of certain functions and assets of the government, and for matters incidental thereto and connected therewith.²² The Act established MAS as the principal banker and fiscal agent of the Government of Singapore. In addition, it sets out MAS' regulatory function for the securities market.

4. *Local Treasury Bills Act (Cap 167)*

The *Local Treasury Bills Act*, designated as LBTA, was passed into law as *Ordinance 4* in 1923 (*Treasury Bills (Local) Ordinance 1923*). It was last revised in 2002 and came into effect on 31 December 2002.²³ Under the Act, Parliament will empower the Minister for Finance to borrow money on behalf of the government by issuing Treasury bills, up to a defined maximum amount. This amount is revisited every financial year. The actual issuance of Treasury bills is facilitated by MAS.

5. *Government Securities Act (Cap 121A)*

The *Government Securities Act*, designated as GSA, was promulgated on 6 March 1992 as *Act 1 of 1992*, and was last revised and came into effect on 31 December 2002.²⁴

V. Definition of Securities

“Securities” is defined under Chapter 29 of the SFA in sections 2(1), 196A, 214, and 239. Such definitions are provided in Table 1.6.

²² Attorney-General's Chamber. http://agcvldb4.agc.gov.sg/non_version/cgi-bin/cgi_retrieve.pl?actno=REVED-186&doctitle=MONETARY%20AUTHORITY%20OF%20SINGAPORE%20ACT%0A&date=latest&method=part

²³ Attorney-General's Chamber. http://statutes.agc.gov.sg/non_version/cgi-bin/cgi_retrieve.pl?actno=REVED-167&doctitle=LOCAL%20TREASURY%20BILLS%20ACT%0A&date=latest&method=part&sl=1

²⁴ Attorney-General's Chamber. http://agcvldb4.agc.gov.sg/non_version/cgi-bin/cgi_retrieve.pl?actno=Reved-121A&date=latest&method=part

Table 1.6 Definitions of Securities under the Securities and Futures Act 2001

Section	Definition
Sec. 2(1)	<p>2. (1) In this Act, unless the context otherwise requires — “securities” means —</p> <ul style="list-style-type: none"> (a) debentures or stocks issued or proposed to be issued by a government; (b) debentures, stocks or shares issued or proposed to be issued by a corporation or body unincorporated; (c) any right, option or derivative in respect of any such debentures, stocks or shares; (d) any right under a contract for differences or under any other contract the purpose or pretended purpose of which is to secure a profit or avoid a loss by reference to fluctuations in — <ul style="list-style-type: none"> (i) the value or price of any such debentures, stocks or shares; (ii) the value or price of any group of any such debentures, stocks or shares; or (iii) an index of any such debentures, stocks or shares; (e) any unit in a collective investment scheme; (f) any unit in a business trust; (g) any derivative of a unit in a business trust; or (h) such other product or class of products as the Authority may prescribe, <p>but does not include —</p> <ul style="list-style-type: none"> (i) futures contracts which are traded on a futures market; (ii) bills of exchange; (iii) promissory notes; (iv) certificates of deposit issued by a bank or finance company whether situated in Singapore or elsewhere; or (v) such other product or class of products as the Authority may prescribe as not being securities
Sec. 196A	<p>196A. In this Division — “debenture” has the same meaning as in section 2 and, in relation to a business trust, means any debenture issued by the trustee of the business trust in its capacity as trustee of the business trust; “securities” —</p> <ul style="list-style-type: none"> (a) in relation to a corporation, for the purposes of sections 196 (a) (i) and (b) (i), 198, 202 and 203, means — <ul style="list-style-type: none"> (i) debentures, stocks or shares issued or proposed to be issued by a corporation; (ii) any right, option or derivative in respect of any such debentures, stocks or shares; (iii) any right under a contract for differences or under any other contract the purpose or pretended purpose of which is to secure a profit or avoid a loss by reference to fluctuations in — <ul style="list-style-type: none"> (A) the value or price of any such debentures, stocks or shares; (B) the value or price of any group of any such debentures, stocks or shares; or (C) an index of any such debentures, stocks or shares; or (iv) such other product or class of products as the Authority may prescribe, <p>but does not include —</p> <ul style="list-style-type: none"> (AA) futures contracts; (BB) bills of exchange;
Sec. 214	<p>214. In this Division — “debenture” has the same meaning as in section 2 and, in relation to a business trust, means a debenture issued by the trustee of the business trust in its capacity as trustee of the business trust;</p>
Sec. 239	<p>239. (1) In this Division — “debenture” includes debenture stock, bonds, notes and any other debt securities issued by a corporation or any other entity, whether or not constituting a charge on the assets of the issuer but does not include —</p> <ul style="list-style-type: none"> (a) a cheque, letter of credit, order for the payment of money or bill of exchange; (b) subject to the regulations made under this Act, a promissory note having a face value of not less than \$100,000 and having a maturity period of not more than 12 months; or (c) for the purposes of the application of this definition to a provision of this Act in respect of which any regulations made thereunder provide that the word “debenture” does not include a prescribed document or a document included in a prescribed class of documents, that document or a document included in that class of documents, as the case may be; <p>“debenture issuance programme” means any scheme or arrangement by an entity for the issue of debentures or units of debentures where only part of the maximum amount or aggregate number of debentures or units of debentures under the programme is offered initially and a further tranche or tranches may be offered subsequently;[sic]</p>

Source: Attorney-General's Chamber. *Securities and Futures Act 2001*.

2. Amendment to the Definition of Securities

Changes to the regulatory and market landscape prompted MAS to incorporate a number of changes to the definition of securities in the Securities and Futures Act 2001. The relevant details are included in Box 1.5.

Box 1.5 Provisions on the Amendment to the Definition of Securities

8 The definition of “securities” in the SFA will be amended to include units and derivatives of units in a business trust so that the provisions under the SFA relating to securities will also apply to business trusts, including provisions relating to market conduct.

With the amendment to the definition of “securities”, [sic] financial advice provided in relation to units and derivatives of units in a business trust will also be regulated under the Financial Advisers Act[1].

SECTION 13: AMENDING THE DEFINITION OF “SECURITIES” AND “FUTURES CONTRACT” IN THE SFA AND THE FAA

28 The definitions of securities (*10) in the SFA and the FAA take the form of a list of products that are designated as securities, and also lists products that are explicitly excluded as securities. It is necessary to amend the SFA each time MAS decides to bring a new product within its regulatory ambit. This affects the time-to-market for new products.

(*10) “Securities” is defined at section 2(1), section 196A, section 214 and section 239 of the SFA. The FAA definition of “securities” references section 2(1) of the SFA.

29 We propose to amend the definitions of “securities” to enable MAS to prescribe new products as “securities” in the SFA and the FAA.

30 We also propose to give MAS the ability to exclude products which might otherwise be caught under the “securities” or “futures contract”(*11) definitions in the SFA and the FAA. This would allow MAS to remove from its regulatory ambit, those products which may not normally be characterised by market participants as financial instruments.

13.1 MAS seeks views on the proposal to amend the definitions of “securities” and “futures contract” in the SFA and the FAA to enable MAS to:

- a. prescribe new products as “securities”; and
- b. prescribe excluded products from the definitions of “securities” and “futures contract”. (*11)

(*11) “Futures contract” is defined at section 2(1) of the SFA and at section 2(1) of the FAA

Source: Singapore Law Academy.

W. Related Legal and Regulatory Issues Behind the Market

Prior to 1973, there was no statutory regulation for the Stock Exchange of Singapore (SES, now SGX). In 1973, the *Securities Industry Act* was enacted. For the most part, the SES was self-regulating, but this changed dramatically in 1985.

In December 1985, the SES and the Kuala Lumpur Stock Exchange were closed for three days after the collapse of Pan-Electric Industries, which came to be known as the Pan-El crisis. The Pan-El crisis precipitated a thorough overhaul of the regulatory framework. The *Securities Industry Act 1973* was repealed and replaced by the *Securities Industry Act 1986*. From that point, there was a general tightening up of securities regulation up to the Asian financial crisis in 1997. Since then, there have been changes in the regulatory balance of the market, culminating in the enactment in 2001 of the *Securities and Futures Act (Chapter 289, 2002 Revised Edition)*, which came into force in various stages in 2002.²⁵

²⁵ Singapore Academy of Law. www.singaporelaw.sg

X. Self-Governing Rules Behind the Market

1. Self-Regulatory Organizations

a. Singapore Exchange

SGX serves as a frontline regulator for the markets and clearing houses that operate in Singapore. SGX works closely with relevant regulatory authorities, including MAS and the Commercial Affairs Department (CAD), to develop and enforce rules and regulations with a view of building an enduring marketplace.

Being a listed exchange and a frontline regulator, SGX is considered a self-regulatory organization (SRO). SGX bears commercial responsibilities in addition to its regulatory duties. While this dual role may present conflicts, SGX has established a framework to manage such conflicts. SGX undertakes various regulatory functions to promote a fair, orderly and transparent marketplace, as well as a safe and efficient clearing system. These functions are handled by the following regulatory departments:

- (i) Issuer Regulation
- (ii) Catalist Regulation
- (iii) Member Supervision
- (iv) Market Surveillance
- (v) Enforcement
- (vi) Risk Management
- (vii) Clearing Risk
- (viii) Regulatory Development and Policy

SGX maintains three boards, the SGX Main Board, Catalist (formerly SGX SESDAQ), and SGX Xtrinet.

The SGX Main Board is comprised of more than two-thirds of the publicly listed companies of under the SGX-ST. These companies are classified into 11 sectors namely, agriculture, multi-industry, manufacturing, mining and resources, transportation and logistics, and infrastructure and property, as well as various services sectors.

Meanwhile, SGX SESDAQ was established in 1987 to enable companies that did not meet the criteria for of the SGX Main Board listings to raise money from the public.

In 2008, this was replaced by Catalist, which is the first sponsor-supervised listing platform in Asia. SGX Xtrinet, on the other hand, was established in 2001 to quote exchange traded funds or SPDRs, which are listed funds, usually in the form of trusts, based on stock market indices.

The SGX also runs a market for trading in shares of foreign companies, called GlobalQuotes. Companies whose shares are traded on GlobalQuotes are merely quoted and not listed on the SGX. As such, they are not subject to SGX's listing rules. Singapore brokers make a market in such shares.

Table 1.7 gives a glimpse at some of the key monthly statistics published by the SGX.

Table 1.7 Singapore Exchange Monthly Market Statistics, October 2011

Items	Aug 2011	Sep 2011
Number of Trading Days (Securities)	21	22
Securities market Turnover Volume (million shares)	33,043	23,089
Securities market Turnover Value (SGD million)	41,421	29,860
Securities Daily Average (SGD million)	1,972	1,357
Total Number of Listed Securities (* Exclude GDRs, Hedge Funds, and Debt Securities.)	775	773
Singapore Companies	459	459
Overseas Companies (excluding China)	164	164
China Companies	152	150
Source: Singapore Exchange; Singapore Academy of Law.		

Y. Bankruptcy Procedures

Singapore has a well-established, comprehensive corporate bankruptcy and insolvency statutory framework, which is largely set forth in the *Companies Act*. The corporate bankruptcy and insolvency laws primarily stem from English and Australian sources, and remain similar in many respects to the legislation of those jurisdictions.

The “Asia-Pacific Restructuring and Insolvency Guide 2006” explains the restructuring and insolvency frameworks of Asia-Pacific Countries.²⁶ The report on Singapore can be found in the fourth to 13th chapters of the Guide.

²⁶ Asian Development Bank. 2006. *The Asia-Pacific Restructuring and Insolvency Guide 2006*. Malaysia: Shearn Delamore & Co. and PricewaterhouseCoopers. <http://www.adb.org/Documents/Guidelines/restructuring-insolvency/restructuring-insolvency.pdf>.

II. Primary and Secondary Markets Regulatory Framework

A. Regulations and Rules on Issuing Debt Instruments

1. Disclosure Requirements for the Issuance of Debentures

Under section 243 of the *Securities and Futures Act 2001* (SFA), a prospectus for an offer of securities shall contain all the information that investors and their professional advisers would reasonably require to make an informed assessment on matters relating to the offer and the issuer. The *Securities and Futures Regulations 2005* (SFR), specifically the provisions on “Offers of Investments” and “Shares and Debentures,” set the specific disclosure requirements for the different types of debentures, including asset-backed securities and structured notes. The SFR also prescribes the disclosure requirements for an offer of debentures under a debenture issuance programme (DIP). The prospectus for an offer of debentures must normally include terms of the debentures, use of proceeds, identity of directors, capitalization and indebtedness, audited financial statements, and interested person transactions. A listed company can make an offer of debentures using an Offer Information Statement (OIS), which is a more concise disclosure document, in place of a prospectus.

2. Debenture Issuance Programme

Under the SFA, an issuer can make multiple offers of bonds using a DIP. The prospectus for an offer of debentures, which is part of a DIP, shall comprise a base prospectus applicable to every offer under the DIP and a pricing statement applicable to a particular offer. The registered base prospectus is valid for 2 years.

3. Stop Order

The Monetary Authority of Singapore (MAS) may, under section 242 of the SFA, serve a stop order on a person making an offer of securities that does not have any further securities allotted, issued or sold. The MAS may do so if a prospectus has been registered and:

- (a) MAS is of the opinion that the prospectus contains a false or misleading statement;
- (b) there is an omission from the prospectus of any information that is required to be included in it;

- (c) MAS is of the opinion that the prospectus does not comply with the requirements of the SFA; or
- (d) MAS is of the opinion that it is in the public interest to do so.

MAS may also serve an interim stop order on the person making the offer. If the interim stop order is served during a hearing, or a hearing commenced while it is in force, the interim stop order will remain in force until MAS serves a stop order. Otherwise, if there is no hearing, the interim stop order will be in force for a period of 14 days, unless it is revoked by MAS.

B. Secondary Market-Related Regulations and Rules on Buying Debt Instruments

1. Ongoing Disclosure Obligations

Section 268 of the SFA provides that where there is a trustee for the holders of any debentures of a borrowing entity, the directors, or equivalent persons of the borrowing entity, are required to lodge on a quarterly basis with the MAS and the trustee a report that sets out any matters adversely affecting the security or the interests of the holders of the debentures. Additionally, profit-and-loss accounts and balance sheets should be lodged with the MAS and the trustee on a semi-annual basis.

Section 203 of the SFA requires an entity with securities listed for quotation on a securities exchange to notify the securities exchange about any information on specified events or matters as they occur or arise in accordance with the rules of the securities exchange.

Also, part VI of chapter 7 of the *SGX Listing Rules* sets out continuing listing obligations in relation to debt securities. Listing Rule 745 states that a debt issuer must disclose to the exchange through the SGXNet any information which may have material effect on the price or value of its debt securities, or on an investor's decision whether to trade in such debt securities. Furthermore, Listing Rule 746 requires a debt issuer to provide the SGX with its published annual reports as soon as it is issued. Listing Rule 747 also requires a debt issuer to announce any redemption or cancellation of debt securities, the details of interest payments to be made, amendments to the trust deed, and any appointment of a replacement trustee.

2. Restrictions for Investors

There are no investment restrictions for investors in bonds.

3. Non-Resident Investor Participation

Nonresidents are allowed to transact Singapore dollar-denominated bonds, asset swaps, interest rate swaps and futures, and other financial products in Singapore. However, if the bond issuer is an unrated foreign entity, banks may only place or sell Singapore dollar-denominated bonds to sophisticated investors, as defined under the *Companies Act*.

Nonresidents can also freely remit funds in and out of Singapore.

MAS also provides a brief guide for nonresidents investing in Singapore government securities (SGS).²⁷

C. Financial Sector Incentive Tax Regimes

The Singapore market features tax incentives for bond investors and intermediaries.

1. Financial Sector Incentive for Intermediaries

For intermediaries, the Enhanced Tier Bond Market Award under the Financial Sector Incentive Scheme, locally known as FSI-BM, allows for:

- (i) Fees from arranging, underwriting, distributing and trading of bonds to be taxed at a concessionary tax rate of 5%; and
- (ii) Automatic qualifying debt securities (QDS) status for debt securities lead-managed by companies approved as FSI-BMs.

As of June 2010, 28 institutions qualified as FSI-BMs. A list of these institutions can be found on the MAS website.²⁸

2. Approved Special Purpose Vehicle Scheme

To encourage securitization, the Tax Incentive Scheme for Approved Special Purpose Vehicle (ASPV) allows for:

- i) tax exemptions on income derived from asset securitization transactions;
- ii) tax exemptions on payment by the ASPV and on over-the-counter (OTC) financial derivatives in connection with securitization transactions to a nonresident who does not have a permanent establishment in Singapore;
- iii) concessions on stamp duties; and
- iv) Goods and Services Tax (GST) recovery.

Details of the scheme can be found in Table 2.1.

²⁷ Singapore Government Securities. http://www.sgs.gov.sg/pub_guide/faqs/publ_faquinvestors.html#15.

²⁸ Monetary Authority of Singapore. http://www.mas.gov.sg/fin_development/debt_market/List_of_FSI_BM_Companies.html

Table 2.1 Details of the Approved Special Purpose Vehicles

Items	Details
Tax incentive	<ul style="list-style-type: none"> • Tax exemption for income derived by an approved special purpose vehicles (ASPV) from asset securitisation transactions. • Withholding tax exemption for payments to nonresidents or non-Singapore permanent establishments for over-the counter (OTC) financial derivatives connected to a securitisation transaction. This exemption also applies for the entire duration of OTC financial derivatives contracts entered into during the qualifying period. • Stamp duty relief on the transfer of assets into the ASPV for approved transactions. • Recovery of goods and services tax (GST) on the ASPV's business expenses at a fixed rate of 76%.
Qualifying transactions	<ul style="list-style-type: none"> • Asset securitisation transactions undertaken by the ASPV must be approved by the MAS. These may involve the transfer of trade receivables, interest-bearing instruments, and rights to any other income quantifiable in advance or any other rights, assets or properties approved by the MAS, excluding immovable property in Singapore. • In the circular, the MAS announced that insurance-related risks may also be transferred to an ASPV, and the capital restriction may be relaxed for SPRVs (see details below).
Qualifying conditions	<ul style="list-style-type: none"> • The following conditions must be met throughout the incentive period: • The ASPV must be: <ul style="list-style-type: none"> ▪ a Singapore-incorporated company with no more than \$10,000 issued and paid-up capital. From 5 November 2007, this restriction may be relaxed for SPRVs registered under the Insurance Act, subject to approval; ▪ a Singapore tax resident; ▪ held in trust for charitable organisations or institutions where the trust is administered by a Singapore trust company; and ▪ set up to conduct asset securitisation activities with no profit-making motive and no other non-incident trade or business may be carried out. • Debt securities issued by ASPVs must meet certain conditions. One of these was that ASPVs were only allowed to issue qualifying debt securities (QDS). From 16 February 2008, this restriction has been removed although non-QDS tranches will be subject to normal tax rules. <p>The MAS will also consider other factors including the extent to which related functions are carried out in Singapore.</p>
Administrative requirements	<ul style="list-style-type: none"> • For income tax purposes, the ASPV must submit an annual declaration confirming that it has met the qualifying conditions, and an undertaking that related party transactions for OTC financial derivatives transactions were carried out at arm's length. • For GST purposes, a quarterly statement is required for GST claims even though the ASPV is not required to register for GST.

Source: Monetary Authority of Singapore. http://www.mas.gov.sg/licensing_guide/insurance/Insurance_Licences.html#sprv; http://www.mas.gov.sg/resource/news_room/announcements/2005/FDDCir09-2005%20Asset%20Securitisation%20Mkt.pdf

3. Qualifying Infrastructure Projects Concession

From November 2006, bonds secured by qualifying infrastructure projects receive an additional concession. All interest income from qualifying project debt securities is fully exempted from tax.

4. Budget 2011: Sector-Specific Tax Changes for Businesses

As part of the implementation of the Budget 2011 measures, the Sector-Specific Tax Changes for Businesses were passed to strengthen Singapore's position as the leading financial center in Asia. Details of the tax changes are reflected in Table 2.2.

Table 2.2 Details on the Tax Change Provisions

Name of Tax Change	Current Treatment	New Treatment
Extension of Tax Incentive Schemes for Project Finance	<p>The package of tax incentive schemes for project finance include:</p> <ul style="list-style-type: none"> a) Exemption of qualifying income from qualifying project debt securities (QPDS); b) Exemption of foreign-sourced interest income from offshore qualifying infrastructure projects or assets received by approved entities listed on the Singapore Exchange (SGX); c) Remission of stamp duty payable on the instrument of transfer relating to qualifying infrastructure projects or assets to qualifying entities listed or to be listed on the SGX; d) Concessionary tax rate of 5% on qualifying income derived by a financial sector incentive-project finance (FSI-PF) company from: <ul style="list-style-type: none"> (i) arranging, underwriting or distributing any QPDS; (ii) arranging or underwriting any qualifying project loan; and (iii) providing project finance advisory services relating to a qualifying infrastructure project; and e) Concessionary tax rate of 10% on qualifying income derived by an approved trustee manager or fund manager from managing qualifying SGX-listed business trusts or infrastructure funds in relation to qualifying offshore infrastructure projects or assets. <p>The sunset clause for these incentive schemes is 31 December 2011.</p>	<p>With the exception of the FSI-PF, the existing package of tax incentive schemes for project finance will be extended until 31 March 2017.</p> <p>The FSI-PF scheme will expire on 31 December 2011. Financial institutions can enjoy similar tax benefits of the FSI-PF under the FSI-Credit Facilities Syndication and FSI-Bond Market tax-incentive schemes.</p> <p>MAS released further details on changes in the tax provision last April 2011.</p>

Source: Inland Revenue Authority of Singapore. <http://www.iras.gov.sg/irasHome/page04.aspx?id=11586>

D. Taxation Framework and Tax Requirements

The Inland Revenue Authority of Singapore (IRAS) administers the tax system in Singapore. It acts as an agent of the Government and provides services in administering, assessing, collecting, and enforcing payment of taxes.

Foreign investors are subject to the following taxes in Singapore:

1. Withholding Tax

The one-tier corporate tax system was introduced by the Ministry of Finance through its 2002 budget. Taking effect on 1 January 2003, the one-tier system replaced the prevalent tax imputation system.

The IRAS had introduced a 5-year transition period during which all companies had to adopt the one-tier tax system. According to the IRAS, the following companies got transferred automatically to the one-tier tax system:

- (i) A resident company with no section 44 balances as of 31 December 2002, taking effect on 1 April 2003.
- (ii) All new companies incorporated on or after 1 January 2003.

a. Dividends

A full imputation system is, however, adopted whereby the tax payable by the company on its corporate profits is passed on as tax credits to its shareholders upon payment of dividends. Normally, under the tax imputation system there are no reclaims by foreign investors. However, investors with domestic income tax exposure may be eligible for rebates if their marginal tax rate is less than the corporate income tax rate of 18%. Under the one-tier corporate tax system, income tax payable on the normal chargeable income of a company is a final tax in Singapore. This means that shareholders will not be taxed on such dividend income. Only companies on the one-tier corporate tax system can issue one-tier exempt dividends.

b. Interest

A withholding tax is imposed on interest paid to non-Singapore tax residents. The withholding tax rate is 15% (a final tax) for interest earned by non-Singapore tax residents not engaged in business in Singapore or having a permanent establishment in Singapore. This rate is further reduced by the Double Tax Agreements (DTAs) between Singapore and the resident country of foreign investors. In cases where relief is sought under the DTAs, a Form IR585 must be submitted to the IRAS. However, interest earned by such non-residents from deposits with an approved Singapore bank is free from withholding tax.

The government of Singapore has announced the extension of the period for tax incentives for the debt market for an additional 5 years until 31 December 2013 for QDS, issued by an approved bond intermediary, or any Singapore financial institution. This would include SGS issued during the period from 28 February 1998 to 31 December 2013.

2. Corporation Income Tax

Resident companies are taxed in Singapore on income accruing in and derived in Singapore. From assessment year 2008, the rate of corporation income tax is 18%.

3. Capital Gains Tax

There is no capital gain tax (CGT) for listed and traded equity shares and fixed-income securities in Singapore, although gains from certain transactions may be deemed as revenue in nature and subject to corporate income tax. Certain gains from the sale of shares in private real property companies may also be considered revenue gains.

4. Double Taxation

Singapore has double taxation treaties with 69 countries. Double taxation agreements in place can be found on the IRAS website.²⁹

5. Goods and Services Tax

Effective 1 April 1999, a GST on domestic consumption was introduced. The tax is paid when money is spent on goods or services, including imports. It is a multi-stage tax, which is collected at every stage of the production and distribution chain. The current GST rate is 7%.

Also, transaction charges and custody fees are subject to GST. However, non-resident investors are exempt from GST.

6. Tax Reclaim

Tax reclaim services are not provided in the Singapore market as there is no withholding tax component for dividend payments. An 18% corporate tax on the company's gross profit will be automatically deducted from clients entitled dividends. For interest payment on corporate bonds or government bonds, there is a general 15% withholding tax applied on non-resident investors.

Clients can directly file for a tax reimbursement, depending on the DTA rates, from the IRAS. IRAS has already put in place an efficient tax reclaim process.

²⁹ Inland Revenue Authority of Singapore. <http://www.iras.gov.sg/irasHome/page.aspx?id=812>

There are no standard forms for the reclaims. As a usual market procedure, the client can write directly to IRAS, for instance at the end of the year, giving details of all the payments eligible for the reduced tax rate.

Custodian banks and other intermediaries may aid investors in the filing of tax reclaims, depending on legal and service level agreements between the parties.

7. Stamp Duty

A stamp duty is imposed on commercial and legal documents relating to shares and immovable property.

For the registration of shares held in the physical form, a stamp duty of SGD10 is applicable for registration with no change of beneficial ownership, and 0.2% of the share price multiplied by quantity and foreign exchange conversion, if applicable. This is then rounded up to the nearest hundred for registration with a change of beneficial ownership.

Transfer taxes in the form of government stamp duties are payable by registered stockholders at the rate of SGD0.20 per SGD100 of Singapore shares.³⁰

8. Regulatory and Tax Information Summary

Table 2.3 summarizes some of the key tax treatments and regulatory considerations for easy reference.

Table 2.3 Summary of Regulatory and Tax Information

Items	SGS Bills	SGS Bonds	Corporate Bonds
Restrictions on Foreign Investment	None	None	None
Capital Gains Tax	None	None	None
Custodian			
Local Investors	MEPS+ Participating Banks	MEPS+ Participating Banks	Central Depository Pte. Ltd
Foreign Investors	MEPS+ Participating Banks	MEPS+ Participating Banks	Depository Agent
Interest Income and Withholding Tax			
All Retail Investors	None	None	None
Resident Institutional Investors	10%	10% (If SGS issued after 28 February 1998)	10% (If QDS)
Non-Resident Institutional Investors	None	None	None
Trading Income Tax			
Financial Institutions	10% (Primary Dealers are exempted)	10% (Primary Dealers are exempted)	18% (5% for FSI-BM companies)
FSI-BM = Financial Sector Incentive-Bond Market; MEPS+ = MAS Electronic Payment System Plus; QDS = qualifying debt securities; SGS = Singapore government securities Source: Monetary Authority of Singapore.			

³⁰ Deutsche Bank AG. 2009. *Direct Securities Service Market Guide–Singapore*.

III. Trading of Bonds and Trading Market Infrastructure

A. Exchange Trading and Over-the-Counter Trading

In January 2011, the Finance Ministry of Singapore announced that SGS bonds can be traded on SGX beginning June 2011. SGS were previously traded only among bond dealers or banks, and bank counter applied to retail investors only; not all SGS are tradable on SGX.

SGX plans to continue enhancing its infrastructure to facilitate bond listing and trading, as well as expanding its product range to include more SGS bonds. SGS bonds are traded over-the-counter between 9:00 a.m. and 4:30 p.m., with a break from 11:30 a.m. to 2:00 p.m. SGD's are traded in multiples of 10 units, equivalent to SGD1,000, of their face value.

The table below provides an overview on how various types of fixed income are traded:

Table 3.1 Fixed Income Products on the Singapore Exchange

	Fixed Income Products on SGX			Stocks
	SGS Bonds	Corporate Bonds	Preference Shares	
Board lot size	In multiples of 10 units	Typically in multiples of 1,000 units	In multiple of: <ul style="list-style-type: none"> ■ 10 units ■ 100 units ■ 1,000 units 	In multiples of 1,000 units
Pricing format	1 unit – S\$100 Face value of SGS Bond Trades on dirty price basis i.e., price quoted and traded includes accrued interest	1 unit – S\$1 Face value of SGS Bond Trades on dirty price basis i.e., price quoted and traded includes accrued interest	Typically 1 unit – S\$1 or S\$100 face value of preference share Trades on dirty price basis i.e., price quoted and traded includes accrued interest	Varied price range depending on valuation of Stock
Minimum denomination for trading	S\$100	Typically S\$1,000	Typically S\$1,000 or S\$10,000	Subject to board lot size
Illustration: For S\$1,000 face value of bonds	Price x Quantity 100.123 x 10 – S\$1001.23	Price x Quantity 1,001 x 1,000 – S\$1001	Price x Quantity 100.123 x 10–S\$1001.23 100.123 x 100–S\$10,012.3 1.001 x 1,000–S\$1,001	

Source: Singapore Exchange.

B. Exchange Trading of Bonds

1. Trading Hours

Trading sessions are held from Mondays to Fridays between 9:00 a.m. and 5:00 p.m. In addition, there is a pre-open routine (8:30 a.m. to 9:00 a.m.) and pre-close routine (5:00 p.m. to 5:06 p.m.).

There is no trading on Singapore public holidays. When a holiday falls on a Sunday, the following Monday will be a public holiday.

Trading on the eves of Christmas, New Year, and the Chinese New Year will be from 9:00 a.m. to 12:30 p.m. The opening routine will be from 8:30 a.m. to 9:00 a.m. and the closing routine from 12:30 p.m. to 12:36 p.m.

The trading size is in units of SGD1,000.

SGX revised the minimum bid size for SGD debentures as shown in Table 3.2 below. The revised minimum bid sizes for listed debentures in foreign currencies are subsequently detailed in Table 3.3.

Table 3.2 Minimum Bid Size for Debentures

Price Range (SGD)	Previous		Current	
	Bid Size (SGD)	Forced Orders (Bids)	Bid Size (SGD)	Forced Orders (Bids)
All	0.001	+/- 30	0.01 or 0.001 as determined by SGX-ST	+/- 30

Notes: This excludes exchange-traded funds, bonds, debentures, loan stocks, and those securities traded in Hong Kong dollar and Japanese yen.
SGX-ST = Singapore Exchange Securities Trading Ltd.
Source: Singapore Exchange

Table 3.3 Revised Hong Kong Dollar and Japanese Yen Minimum Bids Schedule

Products	Revised Hong Kong Dollar Minimum Bids Schedule		
	Price Range (HK\$)	Bid Size (HK\$)	Forced Orders (Bids)
Securities denominated in Hong Kong dollar	Below 0.25	0.001	+/- 10
	0.25 – 0.495	0.005	
	0.50 – 9.99	0.01	
	10.00 – 19.98	0.02	
	20.00 – 99.95	0.05	
	100 – 199.90	0.10	
	200 – 499.80	0.20	
	500 and above	0.50	
Products	Revised Japanese Yen Minimum Bids Schedule		
	Price Range (¥)	Bid Size (¥)	Forced Orders (Bids)
Securities denominated in Japanese yen	Below 2,000	1	+/- 10
	2,000 – 2,995	5	
	3,000 – 29,990	10	
	30,000 – 49,950	50	
	50,000 – 99,900	100	
	100,000 and above	1,000	

Source: Singapore Exchange website. (http://www.sgx.com/wps/portal/sgxweb/home/trading/securities/trading_settlement, then open expansion menu 'Minimum Bid Sizes')

2. All-Day Trading

Singapore Exchange Securities Trading (SGX-ST) has introduced continuous all-day trading (CAT) for the securities market. This will allow users to trade on the SGX between 12:30 p.m. and 2:00 p.m. SGX trading hours will overlap with those of other Asian exchanges, allowing investors in pan-Asian securities to respond to the flow of news from their home markets and provide them greater convenience.

When trading between 12:30 p.m. and 2:00 p.m., investors should be aware that their trading representatives (TR), i.e., their dealers or remisiers, may be away from their desks and news screens. When TRs are away from their desk, member firms (brokerage firms) will apply their existing arrangements, as follows:

- (a) the use of central dealing desks, where the TRs may channel customers' orders to these central dealers, who are also licensed TRs, for order execution;
- (b) the appointment of a back-up TR to handle customers' orders when the primary TR is away from the office;
- (c) the use of mobile technology or hand-held equipment by the TRs to execute customers' orders while they are outside the member's office premises.

It must be noted that under CAT, demand and supply conditions in the market could be less favorable between 12:30 p.m. and 2:00 p.m. than the rest of the trading day. For instance, market volume may be lower as market participants may be unfamiliar with the new hours. This may affect the price and quantity of orders, which can be executed during this period. The level of service from TRs may also be affected. Relaying orders to the market may take a little longer than usual, and response to questions may be less timely. Investors are encouraged to discuss order execution and management with their TRs. Investors using the Internet trading platform, and who occasionally rely on TRs to amend or withdraw their orders, should also discuss order execution and management with their TRs.

With CAT, any resting, unmatched orders queuing in the trading system may be matched throughout the day including during the period between 12:30 p.m. and 2:00 p.m. as the market absorbs news, orders and developments. Investors are reminded to monitor the status of orders given to their TR and the developments of the market all day, including the period from 12:30 p.m. to 2:00 p.m. Investors can also expect to receive a one-off request from their TRs to confirm their awareness of how they will be serviced during the period between 12:30 p.m. to 2:00 p.m. Investors are encouraged to consider carefully how they will like to be serviced by their member and TRs, especially during the period between 12:30 p.m. to 2:00 p.m.

If investors do not wish to use any of the three arrangements during this period, there are other modes of trading available such as online trading through the Internet where you can enter orders directly into members' trading systems. If investors are uncertain about the options available to them or their preferred mode of trading, they may speak to their member and TR.

Trading hours have also been changed and are shown in Figure 3.1.

Figure 3.1 Changes in the Singapore Exchange Trading Hours

Current: Ready and Unit Share Market			New: Ready and Unit Share Market		
Preopen	8:30am	8:59am	Preopen	8:30am	8:59am
Noncancel	8:59am	9:00am	Noncancel	8:59am	9:00am
Open	9:00am	12:30pm	Open	9:00am	5:00pm
Adjust	12:30pm	1:59pm	Preclose	5:00pm	5:05pm
Noncancel	1:59pm	2:00pm	Noncancel	5:05pm	5:06pm
Open	2:00pm	5:00pm	Close	5:06pm	
Preclose	5:00pm	5:05pm			
Noncancel	5:05pm	5:06pm			
Close	5:06pm				

Current: Bond Market			New: Bond Market		
Open	9:00am	12:30pm	Open	9:00am	5:00pm
Lunch	12:30pm	1:59pm	Close	5:00pm	
Open	2:00pm	5:00pm			
Close	5:06pm				

Current: Buying-in Market			New: Buying-in Market		
Open	9:00am	12:30pm	Open	9:00am	5:00pm
Lunch	12:30pm	1:59pm	Close	5:00pm	
Open	2:00pm	5:00pm			
Close	5:06pm				

Source: Singapore Exchange.

Since the SGX introduced all-day trading on 1 August 2011, market prices and data can be generated continuously throughout the day, including the period from 12:30 p.m. to 2:00 p.m., and disseminated through existing data-feed channels, where investors normally obtain such information.³¹

C. Primary Dealer System

SGS primary dealers (PDs) play a critical role in the growth and development of the bond market by carrying out the following functions:

- (i) Provide liquidity to the SGS market by quoting two-way prices under all market conditions;
- (ii) Underwrite issuance at SGS auctions;
- (iii) Provide market feedback to MAS; and
- (iv) Assist in the development of the SGS market.

In return, they are given the following privileges:

³¹ Singapore Exchange Securities Trading. http://www.sgx.com/wps/wcm/connect/sgx_en/home/trading/securities/trading_hours_and_calendar/SGX+Securities+Market+Trades+Non-Stop+All+Day+from+1+August+2011?presentationtemplate=design_new/PT_Print_Friendly

- i. Exclusive dealing with MAS in money market and foreign exchange operations;
- ii. Exclusive access to the MAS Enhanced Repo Facility to borrow SGS issues to facilitate market making;
- iii. Exclusive right to submit applications for SGS at auctions and reverse auctions;
- iv. Higher non competitive tender limit and overall allocation limit at SGS auctions;
- v. Tax exemption on trading income derived from SGS; and
- vi. Close consultation and dialogue with MAS on SGS auctions and market related issues.

Below is a list of the primary dealers for SGS (as of 31 March 2011):

- (i) Australia and New Zealand Banking Group Limited
- (ii) The Royal Bank of Scotland N.V.
- (iii) Bank of America, National Association
- (iv) Barclays Bank PLC
- (v) BNP Paribas
- (vi) Citibank NA
- (vii) Credit Suisse
- (viii) Deutsche Bank AG
- (ix) DBS Bank Ltd.
- (x) Hongkong and Shanghai Banking Corporation Ltd.
- (xi) Oversea Chinese Banking Corporation Ltd.
- (xii) Standard Chartered Bank
- (xiii) United Overseas Bank Ltd.

Other information related to primary dealer operations of SGS can be found on the SGS website.³²

D. Bond Repurchase Market

The repurchase (repo) market is relatively deep with a daily volume of about SGD2.0 billion in 2011. To facilitate trading and market-making by Primary Dealers, the MAS operates a repo facility that allows Primary Dealers to borrow SGS from MAS on an overnight basis when the SGS are not readily available from other sources.

SGS Sale and Repurchase Agreements (Repo)

There are two main types of SGS repo, corresponding to the two main uses of repo transactions. These are the General Collateral (GC) repo and Specific repo.

A General Collateral repo is a collateralized loan, with the underlying SGS—not specified in advance of the transaction—used as the collateral for the cash received during the first leg of the repo transaction. A GC repo is typically used by market participants as a relatively cheaper means to finance their holdings of SGS, and by cash-rich institutions as a secured means of lending cash. Transactions between

³² Singapore Government Securities. http://www.sgs.gov.sg/resource/pub_guide/guides/A%20Guide%20to%20SGS%20PD%20Operations.pdf

Primary Dealers typically use the standard “market lot” for SGS GC repo of USD25 million for tenors from overnight to 1 month.

In a Specific repo, one party of the transaction asks for a specific SGS and contracts with the other party holding the specific SGS to repo out the bond. A Specific Repo is typically used by market participants to cover a short position in SGS. In recent times, Primary Dealers have transacted these through the MAS repo facility. Through the eApps platform, Primary Dealers are also able to submit their closing prices and their MAS repo facility bids, streamlining the repo auction process.

1. Definition

In this section, “buyer” refers to the party who is buying securities under the first leg of a repo, and “seller” refers to the party who is selling the securities under the first leg of a repo.

2. Business Hours

- (i) The normal business hours for T+1 settlement is 9:00 a.m. to 4:30 p.m. from Mondays to Fridays; and
- (ii) The normal business hours for same day settlement are 9:00 a.m. to 3:30 p.m. from Mondays to Fridays.

3. Standard Market Lot Transaction Size

The standard market lot size for repo transactions is SGD25 million. Parties who wish to transact a repo for a different amount should specify the amount when requesting for, or providing, quotes.

4. Settlement

Settlement is usually on the basis of payment against delivery of the security transacted.

5. Repo Cost

Calculation of repo cost is on the basis of 365 days per year.

6. Purchase Price

Unless otherwise agreed between the buyer and the seller, the purchase price shall include the accrued interest. The prevailing market prices shall be used as a guide when determining the purchase price of the securities, which will be known as the dirty price.³³

E. Transparency in Bond Pricing

Bloomberg E-Bond, available to certain users of the BLOOMBERG PROFESSIONAL(R) service through the function EBND < GO >, is a global electronic trading system for bonds and treasury bills. Developed for the Singapore primary-dealer community on

³³ Singapore Government Securities. http://www.sgs.gov.sg/pub_guide/market_practices/publ_mtkpractice.html#sgs1

behalf of the Monetary Authority of Singapore (MAS) for Singapore Government Securities (SGS), Bloomberg E-Bond offers a unique multi-dealer request for quote (RFQ), as well as a quote-driven electronic order book for price providers to leave their bids and offers, along with straight-through-processing (STP) features and real-time market activity displays. SGSM < GO > is the real-time market activity monitor for SGS, and EB < GO > is the main menu for E-Bond functions.

Using Bloomberg E-Bond, Singapore primary dealers now benefit from a flexible, commission-free dealing, trade capture and reporting mechanism while seamlessly offering global investors and market oversight entities a real-time view of price quotations and market activity for SGS. The platform will play a key role in fostering price transparency and liquidity in financial markets in the region.

In July 2005, Bloomberg E-Bond became the interbank dealing platform in Singapore when the initial launch of Bloomberg E-Bond RFQ trading among Singapore primary dealers introduced real-time quote depth and trading information to domestic and foreign market participants. The next phase of Bloomberg E-Bond went live on 3 May 2006, involving the addition of a quote-driven electronic order book for price providers to leave their bids and offers. The incorporation of executable quotes further increased the quality of liquidity and transparency in the SGS market.

Bloomberg E-Bond provides price transparency and liquidity but does not perform matching, execution, clearing or settlement functions.

IV. Description of the Securities Settlement System

A. Dematerialization or Immobilization versus Physical Securities

Most bonds are immobilized. However, some physical bonds are not immobilized at the central securities depository (CSD). Bonds are held in both registered and bearer form.

B. Clearing and Settlement System in Singapore

The Monetary Authority of Singapore's (MAS) role in the oversight of payment and settlement systems is to promote the safety and efficiency of these infrastructures. Thus, MAS is empowered under the *Payment System (Oversight) Act 2006* to supervise payment system operators such as the Automated Clearing House (ACH) and payment system participants.³⁴

MAS oversees the Central Depository Pte. (CDP) and manages the clearing and settlement system for SGS. The CDP operates the clearing and settlement system for securities traded on the Singapore Exchange Securities Trading (SGX-ST) and corporate debt securities.

CDP, established in 1987, is a wholly owned subsidiary of the Singapore Exchange Securities Trading (SGX). It provides integrated clearing, settlement and depository facilities for the securities market, covering both equities and fixed-income instruments. It principally serves the Singapore market, but has links with other CSDs in the United States, Japan and China to support settlement of cross-border trades.

CDP holds the book-entry securities deposited with it as a bare trustee for the collective benefit of depositors. Securities are immobilised at CDP where ownership is transferred through book-entry. The physical certificates of immobilised instruments are safe kept with a CDP-nominated custodian bank.

³⁴ Monetary Authority of Singapore. http://www.mas.gov.sg/fin_development/fin_sec/payment_system/PaymentSettlement.html#EMEAP

CDP processes the daily settlement of funds between settlement banks and CDP through the MAS Electronic Payment System (MEPS+) for all Singapore dollar settlements with effect from 25 February 2011. This is part of CDP's continued efforts to improve efficiency and reduce risk in the securities settlement process. Previously, settlement banks credit CDP's account with the United Overseas Bank Limited on due date. Following this change, settlement banks will credit CDP's account with MAS on due date. The corresponding changes to the settlement timings are highlighted in Table 4.1.

Table 4.1 Main Changes to Settlement Timings

Item	Full-Day Trading
Settlement run	12:00 p.m.–2:00 p.m.
CDP to issue online transmission of final settlement balances to clearing members	2:30 p.m.
Clearing members to pay debit final settlement balances to CDP	By 3:30 p.m.
CDP to pay credit final settlement balances to clearing members	By 4:30 p.m.

Source: Monetary Authority of Singapore.

Also, CDP has amended the terms and conditions for electronic and phone services, which took effect on 16 September 2011.³⁵

Meanwhile, settlement procedures must be in accordance with the operating rules of MEPS+, a real-time gross settlement system designed for funds transfer in SGS transactions. The MEPS+ service agreement can be found in the MAS website.³⁶

C. The Monetary Authority of Singapore Electronic Payment System

The Monetary Authority of Singapore Electronic Payment System (MEPS+) is the Singapore dollar Real-Time Gross Settlement (RTGS) system for the Singapore market. The 'Plus' denotes the latest, more advanced version introduced in December 2006. The original MEPS had been in operation since 1998.

For the purposes of the bond market, MEPS+ is used to capture, process and settle SGS transactions among participants, using two sub-systems. MEPS+ SGS is the platform to transfer SGS between participant accounts while the corresponding cash transfers are effected via MEPS+ RTGS. A link between the securities and cash segments of each transaction enables the settlement of SGS trades on a delivery-versus-payment (DVP) basis.

³⁵ Singapore Exchange Securities Trading Limited. <http://www.sgx.com/wps/wcm/connect/bd1b408047fa3bdd93f4d311587dcf02/Electronic+and+Phone+Services+T%26C.pdf?MOD=AJPERES>

³⁶ Monetary Authority of Singapore. http://www.mas.gov.sg/resource/legislation_guidelines/MEPS+plus/MEPS+plus%20Service%20Agreement%20and%20Rules_Apr2011.pdf

The specific functions and features of MEPS+ in relation to the settlement of SGS transactions are explained in greater detail in the following sections.

For more information, kindly also refer to the Committee on Payment and Settlement System’s (CPSS) publication.³⁷

D. Bond Market Infrastructure Diagram

Figure 4.1. shows the key elements of the bond market infrastructure in Singapore.

Figure 4.1 Bond Market Infrastructure

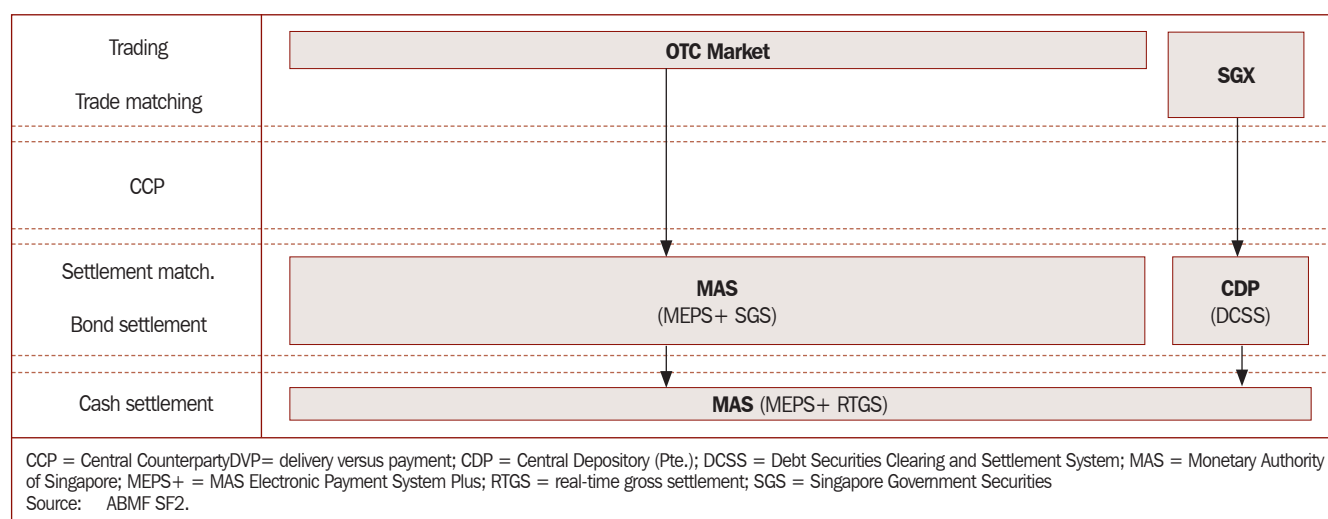

E. Business Process Flowchart Level 2: Singapore Bond Market and Delivery versus Payment

The delivery-versus-payment settlement for Singapore Government Securities (SGS) is illustrated in Figure 4.2, using the business process flow of a typical domestic transaction. The individual steps are detailed after the flowchart and explained in context in section G.

³⁷ Committee on Payment and Settlement Systems (CPSS). 2011. "Payment, clearing and settlement systems in Singapore," *Payment, Clearing and Settlement Systems in the CPSS Countries*. Switzerland: Bank for International Settlements. http://www.bis.org/publ/cpss97_sg.pdf

Figure 4.2 Business Process Flowchart Level 2

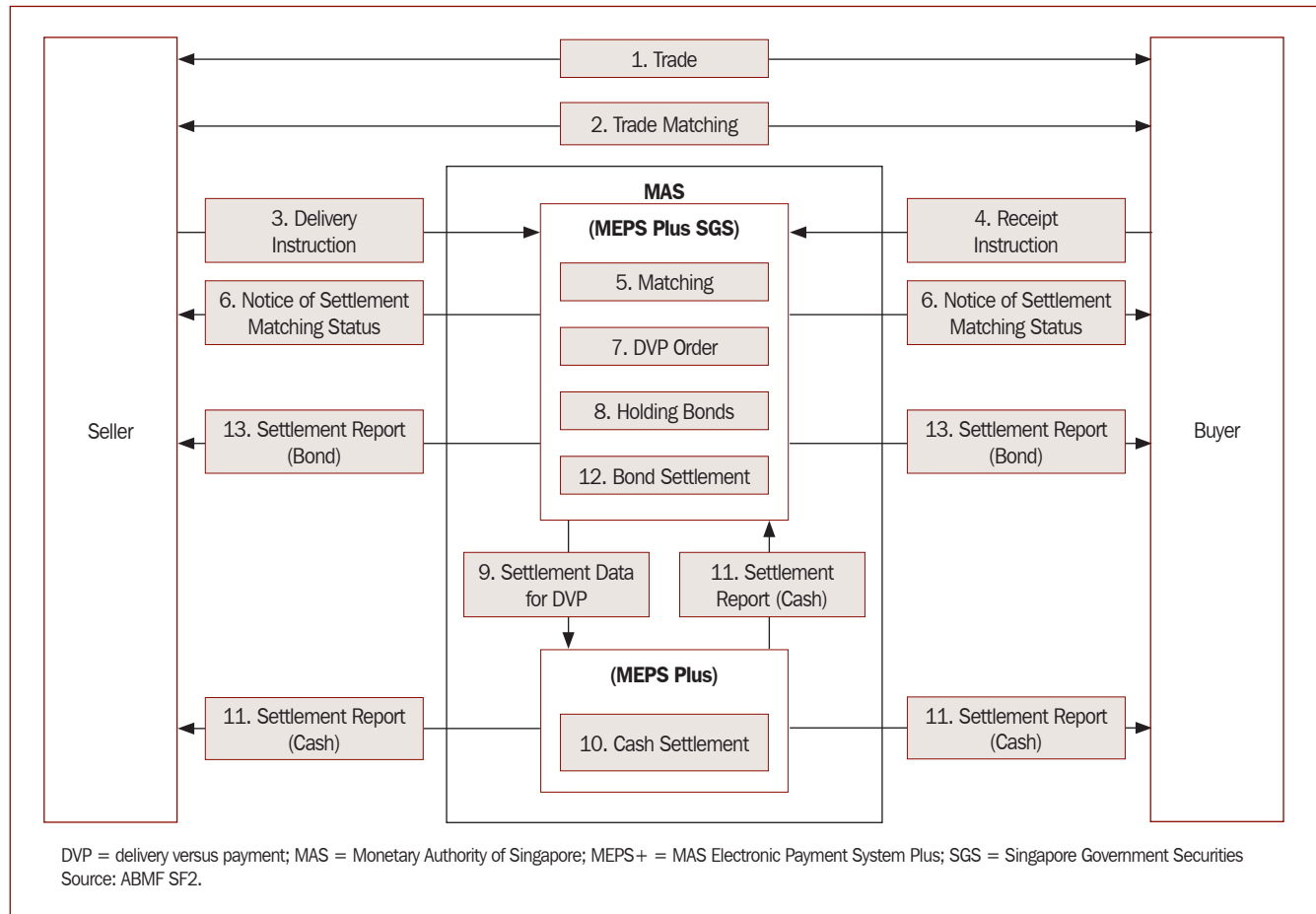

1. Singapore Government Securities (SGS) is done on an over-the-counter basis.
2. Trades are matched among seller and buyer.
3. The bond seller sends the agreed trade instruction to MEPS+ SGS.
4. The bond buyer sends the agreed trade instruction to MEPS+ SGS.
5. MEPS+ SGS performs bond matching.
6. MEPS+ SGS sends the notice of bond matching status to seller and buyer..
7. MEPS Plus Book-entry clearing system creates the DVP order.
8. When the seller's SGS account has sufficient SGS, the SGS are earmarked for transfer to the buyer.
9. Settlement data for DVP is sent to MEPS+ RTGS.
10. When the funds are available, the amount is debited from the buyer's RTGS account and credited to the seller's RTGS account.
11. MEPS+ RTGS simultaneously MEPS+ SGS to transfer the securities and reports the cash settlement status to both sides of the trade.
12. MEPS Plus Book-entry clearing system transfer the bonds to the buyer's account.
13. MEPS Plus Book-entry clearing system reports the settlement status to both seller and buyer.

F. Over-the-Counter Bond Transaction Flow for Foreign Investors

When foreign institutional investors transact SGS, a number of additional process steps will need to be considered. Figure 4.3 illustrates a cross-border bond transaction flow, including funding and foreign exchange components. The individual steps are explained in greater detail after the flowchart.

Figure 4.3 Over-the-Counter Bond Transaction Flow for Foreign Investors

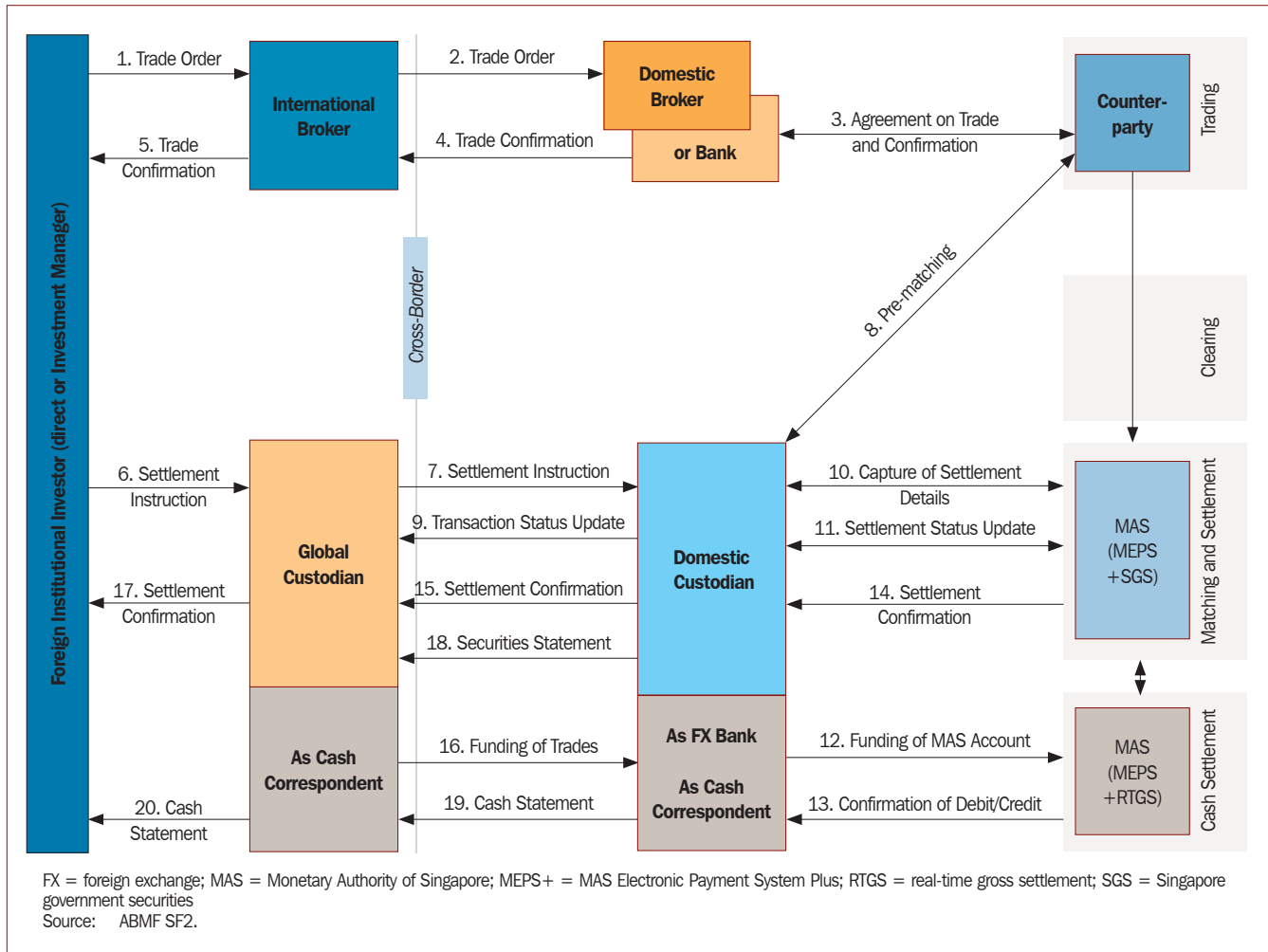

Below is the description of steps in the flowchart.

(1) Trade Date

1. Foreign institutional investor places order with international broker
2. International broker places order with domestic broker
3. Domestic broker or bank trades over-the-counter (OTC) with counterparty (through phone, Bloomberg)
4. Domestic broker or bank sends trade confirmation to international broker
5. Foreign institutional investor receives trade confirmation

(2) Settlement Date / T+1

6. Foreign institutional investor instructs global custodian on securities settlement details and funding details
7. Global custodian instructs domestic custodian on securities settlement details
8. Domestic custodian and counterparty pre-match settlement details through phone
9. Domestic custodian provides result of pre-matching to global custodian
10. Domestic custodian transmits settlement details to MAS (MEPS+)
11. Domestic custodian monitors settlement status updates (online)
12. Domestic custodian funds MAS account through MEPS+
13. Upon transfer of cash, debit or credit confirmation from MAS through MEPS+
14. Upon transfer of securities, settlement confirmation from MAS through MEPS+
15. Domestic custodian sends settlement confirmation to global custodian
16. Global custodian funds Singapore dollar account with domestic custodian, or foreign currency nostro (before end of day)
17. Global custodian sends settlement confirmation to foreign institutional investor
18. Domestic custodian sends securities statement to global custodian
19. Domestic custodian sends debit or credit confirmations as cash statement to global custodian
20. Global custodian sends cash statement to foreign institutional investor

G. Settlement Schemes for Government Bonds, Corporate Bonds and Other Bonds

1. Singapore Government Securities

MAS acts as the agent for the Government of Singapore in issuing SGS that comprise

Treasury bills (T-bills) and government bonds. Maturities range from 3 months to 15 years with 3-month and 1-year benchmarks for T-bills, and 2-, 5-, 10-, 15-, 20- and 30-year benchmarks for bonds. Since May 2000, the Government's issuance program has aimed to build large and liquid benchmark bonds. This has been achieved through larger issuances of new SGS bonds and re-openings of existing issues, thereby enlarging the free float of SGS available for trading.

For SGS, settlement of successful auction bids takes place on the issue date, which is usually 2 business days following the auction date. Settlement is via MEPS+, which is a Real Time Gross Settlement System (RTGS), on a delivery versus payment (DVP) basis. For non-Primary Dealers without MEPS+ accounts, the book-entry, scripless SGS allotted to them will be held in custody on their behalf by the Primary Dealers with whom they have set up custody accounts.

Singapore dollar corporate bonds are usually custodied by the CDP. All securities are settled on a DVP basis, usually within T+3 days. Investors may also settle via Euroclear or Clearstream, both of which have links to the CDP.

VI. Costs and Charging Methods

A. Exchange Fees

The SGX provides a menu of exchange fees to be paid.³⁸

1. Initial Listing Fee

In the issuance of bonds, notes, or other debt securities denominated in local or foreign currency, the following initial fees are payable upon submission of the listing application:

- (i) a fixed fee of SGD15,000; and
- (ii) a non-refundable processing fee of SGD10,000.

2. Additional Listing Fees

No additional listing fee is payable if the issuer issues additional debt securities of a series, which has an existing listing on the exchange.

3. Annual Dues

No annual fee is payable to the exchange.

³⁸ Singapore Exchange Securities Trading Limited. http://www.sgx.com/wps/portal/sgxweb/home/listings/listing_products#panelhead3

Table 5.1 Selected Costs and Charging Methods in the Singapore Bond Market

Type	Details	Remarks
Singapore Government Securities (SGS) settled via MEPS+		
Message Fee	SGD1.45 per message (transaction instruction)	
Additional Time Block Charges (late settlement fee)	SGD0.25 for every transaction settled between 2.30pm and 4pm SGD1.05 for every transaction settled between 4pm and 5.30pm	
Trades on Singapore Exchange, settled via CDP		
Brokerage Fee (exchange market only)	Taking effect from 1 October 2000, brokerage rates are fully negotiable for all transactions on the Singapore Exchange Securities Trading Limited (SGX). Minimum brokerage fee is SGD40.	
Clearing Fee	0.04% on the value of the contract, subject to a maximum of SGD600.	
Buy-in Brokerage Fees	Buy-in brokerage is fixed at a rate of 0.75% subject to a minimum of brokerage of SGD10 per trade of 500 units or more and SGD3 per trade for less than 500 units. SGX access fees chargeable at 0.0075% of the value of the contract would also be levied together with 0.04% of clearing fees chargeable as well (maximum SGD600). In addition, a processing fee of SGD30 will be levied for every buying-in contract or withdrawal of buying-in. Taking effect from 25 September 2008 onwards, there is an additional penalty fee of 5% of the buy-in value subject to a minimum of SGD1,000. With effect from trades settling on 30 November 2009, this penalty fee is only applicable if buy-in is unsuccessful on T+3.	
Goods and Services Tax (GST)	7% on brokerage and clearing fees is applicable to Singapore residents; non-residents are exempt from GST.	
Debt Securities Settlement Fee (in CDP/DCSS)	\$S2.00 per settlement per side	
Registration fees		
Registration of Physical Certificates		
No Change of Beneficial Ownership (NCBO)		
Scrip fees	SGD2.14 per certificate or transfer deed (whichever is greater)	
Cancellation Fee	SGD1.07 per certificate submitted	
Stamp Duty	SGD10.00 per transfer deed	
Conversion Charges	SGD20.70 per certificate (SGD10.70 CDP deposition fees + SGD10)	
Change of Beneficial Ownership		
Scrip Fees	SGD2.14 per certificate or transfer deed (whichever is greater)	
Cancellation Fee	SGD1.07 per certificate submitted	
Stamp Duty	SGD(0.2% x [Security] Price x Quantity) (Based on market value)	
Conversion Charges	SGD20.70 per certificate (SGD10.70 CDP deposition fees + SGD10)	
Note: NCBO = No Change in Beneficial Ownership Source: DBS Bank, 2011. <i>DBS Bank Securities Market Guide Singapore.</i>		

VII. Market Size and Statistics

A. Size of Local Currency Bond Market in Percentage of Gross Domestic Product (Local Sources)

Table 6.1 Size of Local Currency Bond Market (% GDP)

Date	Government (% GDP)	Corporate (% GDP)	Total (% GDP)	Government (\$ billions)	Corporate (\$ billions)	Total (\$ billions)
Dec-95	15.0	8.9	24.0	13.12	7.78	20.90
Dec-96	15.3	10.4	25.7	14.65	10.01	24.66
Dec-97	14.8	12.2	27.1	13.05	10.73	23.77
Dec-98	20.1	14.1	34.2	17.36	12.12	29.48
Dec-99	24.5	18.8	43.3	21.19	16.21	37.40
Dec-00	26.6	20.9	47.5	24.93	19.60	44.53
Dec-01	34.1	30.4	64.5	29.06	25.85	54.91
Dec-02	35.8	29.6	65.3	33.47	27.67	61.14
Dec-03	37.7	30.5	68.2	37.10	30.01	67.11
Dec-04	37.9	30.6	68.5	44.25	35.73	79.97
Dec-05	37.4	28.8	66.2	46.90	36.20	83.10
Dec-06	37.2	28.9	66.0	55.79	43.37	99.17
Mar-07	36.3	28.0	64.2	56.90	43.89	100.80
Jun-07	37.7	28.4	66.2	60.90	45.88	106.79
Sep-07	37.6	27.0	64.6	65.18	46.84	112.02
Dec-07	36.7	28.8	65.6	68.12	53.54	121.66
Mar-08	37.9	29.5	67.4	75.17	58.46	133.63
Jun-08	39.4	29.4	68.8	79.43	59.36	138.79
Sep-08	37.1	30.0	67.0	70.78	57.19	127.97
Dec-08	39.0	29.0	68.1	73.14	54.40	127.54
Mar-09	41.2	28.5	69.6	71.05	49.12	120.17
Jun-09	44.4	28.9	73.3	79.94	51.95	131.89
Sep-09	47.1	30.0	77.1	86.97	55.52	142.49
Dec-09	46.4	27.8	74.2	88.05	52.74	140.79
Mar-10	45.6	29.4	75.0	90.49	58.31	148.80
Jun-10	44.3	29.1	73.4	91.54	60.17	151.71
Sep-10	43.1	30.4	73.5	97.31	68.69	166.00
Dec-10	43.6	31.9	75.5	103.09	75.58	178.66
Mar-11	42.7	34.3	77.1	105.75	84.87	190.62

Source: AsianBondsOnline, http://www.asianbondsonline.adb.org/singapore/data/bondmarket.php?code=LCY_in_GDP_Local

B. Issuance Volume of Local Currency Bond Market

Table 6.2 Issuance Volume of Local Currency Bond Market (\$ billions)

Date	Government	Corporate	Total
Mar-95	4.36	0.15	4.52
Jun-95	3.91	0.31	4.23
Sep-95	4.59	0.11	4.69
Dec-95	4.24	0.62	4.86
Mar-96	4.73	0.20	4.93
Jun-96	4.20	0.08	4.28
Sep-96	4.76	0.26	5.02
Dec-96	4.37	0.39	4.75
Mar-97	3.71	0.09	3.80
Jun-97	5.05	0.37	5.42
Sep-97	3.90	0.34	4.24
Dec-97	4.40	0.09	4.49
Mar-98	4.18	0.05	4.22
Jun-98	4.60	0.00	4.61
Sep-98	6.39	0.10	6.50
Dec-98	6.07	0.32	6.39
Mar-99	5.07	0.36	5.43
Jun-99	6.30	0.50	6.80
Sep-99	6.27	1.02	7.29
Dec-99	7.57	0.66	8.23
Mar-00	7.31	0.24	7.55
Jun-00	8.00	0.81	8.80
Sep-00	7.78	1.67	9.45
Dec-00	8.12	1.18	9.30
Mar-01	7.55	1.77	9.32
Jun-01	8.20	2.54	10.74
Sep-01	8.33	2.72	11.05
Dec-01	8.32	0.87	9.19
Mar-02	6.16	0.38	6.54
Jun-02	8.63	0.93	9.56
Sep-02	8.29	0.22	8.51
Dec-02	10.35	0.63	10.98
Mar-03	8.13	0.69	8.83
Jun-03	10.02	0.71	10.73
Sep-03	9.26	1.12	10.38
Dec-03	9.12	1.41	10.53
Mar-04	10.15	1.75	11.90
Jun-04	10.54	0.81	11.35
Sep-04	12.71	1.34	14.05
Dec-04	12.50	1.18	13.69
Mar-05	11.87	0.35	12.22
Jun-05	12.93	1.13	14.07
Sep-05	13.36	0.64	14.00
Dec-05	11.91	1.03	12.94

continued on next page

Table 6.2 continuation

Date	Government	Corporate	Total
Mar-06	12.32	1.11	13.43
Jun-06	14.85	0.80	15.64
Sep-06	14.99	1.76	16.74
Dec-06	15.09	1.41	16.50
Mar-07	18.20	0.72	18.92
Jun-07	21.50	2.34	23.84
Sep-07	18.99	0.70	19.69
Dec-07	22.43	1.41	23.84
Mar-08	23.55	2.49	26.04
Jun-08	29.93	1.14	31.07
Sep-08	23.90	5.83	29.72
Dec-08	23.42	0.15	23.58
Mar-09	26.00	0.79	26.79
Jun-09	31.78	1.69	33.47
Sep-09	33.20	2.01	35.21
Dec-09	38.72	1.62	40.34
Mar-10	32.09	3.68	35.78
Jun-10	38.45	2.52	40.96
Sep-10	42.31	4.33	46.64
Dec-10	42.93	4.38	47.31
Mar-11	44.11	2.97	47.08
Jun-11	48.43	2.93	51.37

Source: AsianBondsOnline, http://www.asianbondsonline.adb.org/singapore/data/bondmarket.php?code=Issuance_Volume_LCY

C. Bond Trading Volume

Table 6.3 Trading Volume (\$ billions)

Year	Government Bonds	Corporate Bonds	Total
Mar-05	32.49	-	32.49
Jun-05	29.80	-	29.80
Sep-05	38.81	-	38.81
Dec-05	29.84	-	29.84
Mar-06	29.01	-	29.01
Jun-06	31.73	-	31.73
Sep-06	41.35	-	41.35
Dec-06	32.27	-	32.27
Mar-07	45.42	-	45.42
Jun-07	50.34	-	50.34
Sep-07	48.79	-	48.79
Dec-07	39.05	-	39.05
Mar-08	71.25	-	71.25
Jun-08	86.53	-	86.53
Sep-08	60.92	-	60.92

continued on next page

Table 6.3 continuation

Year	Government Bonds	Corporate Bonds	Total
Dec-08	72.83	-	72.83
Mar-09	63.28	-	63.28
Jun-09	52.20	-	52.20
Sep-09	46.65	-	46.65
Dec-09	41.74	-	41.74
Mar-10	46.81	-	46.81
Jun-10	80.61	-	80.61
Sep-10	98.26	-	98.26
Dec-10	82.52	-	82.52
Mar-11	76.64	-	76.64
Jun-11	73.32	-	73.32

Source: AsianBondsOnline. http://www.asianbondsonline.adb.org/singapore/data/bondmarket.php?code=Trading_Volume

D. Breakdown of Local Currency Government Bond Market Issuance

Table 6.4 Government Issuance Breakdown (\$ billions)

Date	Central Bank	Other Government Entities	Central Government	Central Bank (% of Total)	Other Government Entities (% of Total)	Central Government (% of Total)
Mar-95	0	0	4.36	0	0	100
Jun-95	0	0	3.91	0	0	100
Sep-95	0	0	4.59	0	0	100
Dec-95	0	0	4.24	0	0	100
Mar-96	0	0	4.73	0	0	100
Jun-96	0	0	4.20	0	0	100
Sep-96	0	0	4.76	0	0	100
Dec-96	0	0	4.37	0	0	100
Mar-97	0	0	3.71	0	0	100
Jun-97	0	0	5.05	0	0	100
Sep-97	0	0	3.90	0	0	100
Dec-97	0	0	4.40	0	0	100
Mar-98	0	0	4.18	0	0	100
Jun-98	0	0	4.60	0	0	100
Sep-98	0	0	6.39	0	0	100
Dec-98	0	0	6.07	0	0	100
Mar-99	0	0	5.07	0	0	100
Jun-99	0	0	6.30	0	0	100
Sep-99	0	0	6.27	0	0	100
Dec-99	0	0	7.57	0	0	100
Mar-00	0	0	7.31	0	0	100
Jun-00	0	0	8.00	0	0	100
Sep-00	0	0	7.78	0	0	100

continued on next page

Table 6.4 continuation

Date	Central Bank	Other Government Entities	Central Government	Central Bank (% of Total)	Other Government Entities (% of Total)	Central Government (% of Total)
Dec-00	0	0	8.12	0	0	100
Mar-01	0	0	7.55	0	0	100
Jun-01	0	0	8.20	0	0	100
Sep-01	0	0	8.33	0	0	100
Dec-01	0	0	8.32	0	0	100
Mar-02	0	0	6.16	0	0	100
Jun-02	0	0	8.63	0	0	100
Sep-02	0	0	8.29	0	0	100
Dec-02	0	0	10.35	0	0	100
Mar-03	0	0	8.13	0	0	100
Jun-03	0	0	10.02	0	0	100
Sep-03	0	0	9.26	0	0	100
Dec-03	0	0	9.12	0	0	100
Mar-04	0	0	10.15	0	0	100
Jun-04	0	0	10.54	0	0	100
Sep-04	0	0	12.71	0	0	100
Dec-04	0	0	12.50	0	0	100
Mar-05	0	0	11.87	0	0	100
Jun-05	0	0	12.93	0	0	100
Sep-05	0	0	13.36	0	0	100
Dec-05	0	0	11.91	0	0	100
Mar-06	0	0	12.32	0	0	100
Jun-06	0	0	14.85	0	0	100
Sep-06	0	0	14.99	0	0	100
Dec-06	0	0	15.09	0	0	100
Mar-07	0	0	18.20	0	0	100
Jun-07	0	0	21.50	0	0	100
Sep-07	0	0	18.99	0	0	100
Dec-07	0	0	22.43	0	0	100
Mar-08	0	0	23.55	0	0	100
Jun-08	0	0	29.93	0	0	100
Sep-08	0	0	23.90	0	0	100
Dec-08	0	0	23.42	0	0	100
Mar-09	0	0	26.00	0	0	100
Jun-09	0	0	31.78	0	0	100
Sep-09	0	0	33.20	0	0	100
Dec-09	0	0	38.72	0	0	100
Mar-10	0	0	32.09	0	0	100
Jun-10	0	0	38.45	0	0	100
Sep-10	0	0	42.31	0	0	100
Dec-10	0	0	42.93	0	0	100
Mar-11	0	0	44.11	0	0	100
Jun-11	0	0	48.43	0	0	100

Source: AsianBondsOnline. http://www.asianbondsonline.adb.org/singapore/data/bondmarket.php?code=Issuance_Breakdown

E. Size of Foreign Currency Bond Market

Table 6.5 Foreign Currency Bonds to Gross Domestic Product Ratio (\$ billions)

Date	as % of Gross Domestic Product	Foreign Currency Denominated Bonds (\$ billions)	Gross Domestic Product (\$ billions)
Dec-95	1.2	1.1	87.3
Dec-96	1.7	1.6	95.9
Dec-97	3.2	2.8	87.9
Dec-98	5.1	4.4	86.3
Dec-99	7.5	6.5	86.4
Dec-00	9.4	8.8	93.7
Dec-01	18.7	16.0	85.1
Dec-02	17.6	16.5	93.6
Dec-03	22.4	22.1	98.4
Mar-04	22.4	22.4	99.8
Jun-04	24.3	24.5	100.6
Sep-04	26.0	27.6	106.1
Dec-04	27.6	31.3	113.5
Mar-05	28.1	32.0	114.1
Jun-05	28.5	32.5	114.0
Sep-05	29.9	34.8	116.2
Dec-05	30.1	36.5	121.4
Mar-06	29.0	37.0	127.6
Jun-06	30.6	40.9	133.5
Sep-06	30.6	41.8	136.6
Dec-06	29.0	43.6	150.2
Mar-07	29.3	45.9	156.9
Jun-07	31.3	50.6	161.4
Sep-07	29.7	51.5	173.3
Dec-07	28.3	52.6	185.6
Mar-08	27.0	53.5	198.2
Jun-08	26.5	53.5	201.8
Sep-08	27.7	52.9	190.9
Dec-08	27.4	51.3	187.4
Mar-09	27.8	47.9	172.6
Jun-09	25.5	45.8	180.0
Sep-09	25.6	47.4	184.8
Dec-09	26.0	49.4	189.8
Mar-10	24.8	49.2	198.4
Jun-10	23.5	48.5	206.6
Sep-10	23.5	53.0	225.8
Dec-10	22.7	53.7	236.6
Mar-11	22.7	56.2	248.0
Jun-11	22.5	57.7	257.0

FCY = foreign currency; GDP = gross domestic product
Source: Asian Bonds Online. http://asianbondsonline.adb.org/singapore/data/bondmarket.php?code=FCY_in_GDP

F. Size of Foreign Currency Bond Market (Local Sources)

Table 6.6 Foreign Currency Bonds Outstanding (\$ billions)

Date	Government	Banks and Financial Institutions	Other Corporates	Total FCY
Mar-04	0	7.13	10.20	17.33
Jun-04	0	7.74	10.18	17.92
Sep-04	0	8.85	10.19	19.04
Dec-04	0	9.71	10.31	20.02
Mar-05	0	9.36	10.18	19.55
Jun-05	0	9.34	9.84	19.18
Sep-05	0	11.00	10.07	21.07
Dec-05	0	11.34	10.69	22.03
Mar-06	0	11.29	10.69	21.98
Jun-06	0	12.12	11.46	23.58
Sep-06	0	12.24	11.10	23.34
Dec-06	0	12.25	11.18	23.43
Mar-07	0	11.95	11.28	23.23
Jun-07	0	13.51	11.46	24.97
Sep-07	0	13.33	11.97	25.30
Dec-07	0	13.24	12.39	25.63
Mar-08	0	13.55	11.94	25.50
Jun-08	0	13.68	11.90	25.57
Sep-08	0	13.72	11.72	25.44
Dec-08	0	13.78	11.01	24.79
Mar-09	0	13.65	10.56	24.22
Jun-09	0	13.61	10.72	24.33
Sep-09	0	12.88	11.67	24.55
Dec-09	0	15.85	12.55	28.40
Mar-10	0	15.95	12.08	28.03
Jun-10	0	16.18	12.76	28.94
Sep-10	0	19.62	11.96	31.59
Dec-10	0	20.61	11.88	32.49
Mar-11	0	21.12	13.51	34.63

Note: FCY = foreign currency
Source: AsianBondsOnline. http://asianbondsonline.adb.org/singapore/data/bondmarket.php?code=FCY_Bonds_Outstanding

G. Domestic Financing Profile

Table 6.7 Domestic Financing Profile

Date	Domestic Credit (% of Total)	Bonds (% of Total)	Equity (% of Total)	Domestic Credit (\$ billions)	Bonds (\$ billions)	Equity (\$ billions)	Total (\$ billions)
Dec-00	29.16	15.80	55.04	82.17	44.53	155.13	281.82
Dec-01	33.00	21.36	45.64	84.82	54.91	117.34	257.07
Dec-02	31.88	25.60	42.52	76.13	61.14	101.55	238.83
Dec-03	27.73	22.49	49.77	82.75	67.11	148.50	298.36
Dec-04	22.96	20.70	56.33	88.70	79.98	217.62	386.29
Dec-05	19.54	19.64	60.82	82.70	83.10	257.34	423.14
Dec-06	17.02	17.02	65.96	99.19	99.16	384.29	582.63
Mar-07	16.75	15.63	67.62	107.96	100.79	435.97	644.73
Jun-07	16.11	14.63	69.26	117.58	106.78	505.59	729.95
Sep-07	16.61	14.36	69.03	129.55	112.02	538.34	779.91
Dec-07	17.09	15.26	67.64	136.24	121.66	539.18	797.08
Mar-08	19.74	17.30	62.97	152.49	133.63	486.49	772.61
Jun-08	19.88	17.82	62.29	154.86	138.79	485.15	778.80
Sep-08	24.02	20.37	55.61	150.92	127.97	349.45	628.34
Dec-08	27.84	23.45	48.71	151.42	127.54	264.97	543.94
Mar-09	29.46	22.96	47.58	154.20	120.17	249.00	523.37
Jun-09	24.37	19.95	55.68	161.08	131.89	367.99	660.95
Sep-09	22.32	18.83	58.85	168.86	142.49	445.18	756.53
Dec-09	22.24	17.60	60.16	177.93	140.79	481.25	799.97
Mar-10	22.25	18.06	59.68	183.30	148.80	491.64	823.74
Jun-10	21.62	18.03	60.36	181.92	151.71	507.97	841.60
Sep-10	20.76	17.23	62.01	199.97	166.00	597.33	963.30
Dec-10	20.20	17.26	62.53	209.09	178.67	647.23	1034.98
Mar-11	21.19	17.87	60.94	226.05	190.62	650.05	1066.72

Source: AsianBondsOnline. http://asianbondsonline.adb.org/singapore/data/bondmarket.php?code=Domestic_Financing_profile

VIII. Next Step ⇔ Future Direction

A. Future Direction

1. Extension of the Benchmark Yield Curve

MAS took steps to increase liquidity and extend the SGS benchmark yield curve from 15 years to the current 20-year mark in 2007. In 2012, the yield curve will be further extended to 30 years. The new 30-year SGS benchmark will establish a liquid reference benchmark for corporate issuance that is more closely aligned with that of other developed markets, and, at the same time, address insurers' pent-up demand for longer maturity bonds.

2. Diversification of Investor Base

Individual investor access to SGS was improved in 2009 when the automated teller machine (ATM) networks of the local banks were enabled to allow access to primary auctions. Building on these efforts in the primary market, retail access to the secondary market was also improved as individuals were allowed to trade SGS on the Singapore Exchange from July 2011. This measure created a more diversified investor base and helped to unlock retail demand for fixed income instruments. Issuers including SIA, CapitaMall and F&N, took the opportunity to offer a portion of their recent bond issuances to the public.

3. Broadening the Issuer Base

In an effort to boost issuances by foreign entities, regulations were fine-tuned in 2009 to qualify high-grade securities issued by AAA-rated supranationals, sovereigns and sovereign-guaranteed companies as regulatory liquid assets. The list of issuers was subsequently extended in 2010 to include public sector entities that were AAA-rated and zero risk-weighted. Subsequently, several AAA-rated foreign issuers such as the African Development Bank, International Finance Corporation, KfW Bankengruppe, and World Bank, tapped the Singapore dollar bond market.

MAS also recognizes the need to deepen the foreign exchange swap market to encourage issuance by foreign entities in the Singapore dollar bond market. An illiquid swap market, particularly in the longer end, remains an obstacle to the competitive pricing of bonds as it creates uncertainty in the pricing process. Concerted efforts will be made in the year ahead to address the impediments in the swap market.

4. Fostering the Growth of an Active Secondary Market

A deep and liquid secondary market is crucial for a functional debt capital market with transparent and reliable prices within a stable financial system. MAS is continuing to review measures aimed at strengthening the market-making mechanism and improving price transparency in the corporate bond market.

B. Group of 30 Compliance

The so-called G-30 Recommendations were originally conceived as the Group of Thirty's Standards on Securities Settlement Systems in 1989, detailing in a first of its kind report nine recommendations for efficient and effective securities markets and covering legal, structural and settlement process areas. The recommendations were subsequently reviewed and updated in 2001, under leadership of the Bank for International Settlements (BIS), and through the efforts of a Joint Task Force of the Committee On Payment and Settlement Systems (CPSS) and the Technical Committee of the International Organisation of Securities Commissions (IOSCO). Compliance with the G30 Recommendations in individual markets is often an integral part in securities industry participants' and intermediaries' due diligence process.

Table 7.1 Group of 30 Compliance

	Recommendation	Implemented
1	Eliminate paper and automate communication, data capture, and enrichment.	No.
2	Harmonize messaging standards and communication protocols.	Yes. We are currently using ISO15022 for our securities messaging.
3	Develop and implement reference data standards.	Yes. We use common data standards such as ISIN and SWIFT BICs. This is only valid for MEPS+ of MAS; SGX/CDP uses a prop standard that is largely based on ISO but still requires specially formatted messages between participants and CSD.
4	Synchronize timing between different clearing and settlement systems and associated payment and foreign exchange systems.	No.
5	Automate and standardize institutional trade matching.	Yes.
6	Expand the use of central counterparties.	Yes. However, there are classes of financial instruments not yet cleared through a CCP.
7	Permit securities lending and borrowing to expedite settlement.	Yes. Currently, there are 173 securities in the lending pool with the central depository.
8	Automate and standardize asset servicing processes, including corporate actions, tax relief arrangements, and restrictions on foreign ownership.	Corporate actions: No Taxation: No Foreign ownership restrictions: No
9	Ensure the financial integrity of providers of clearing and settlement services.	Yes.
10	Reinforce the risk management practices of users of clearing and settlement service providers.	Yes.
11	Ensure final. Simultaneous transfer and availability of assets.	No.
12	Ensure effective business continuity and disaster recovery planning.	Yes.
13	Address the possibility of failure of a systematically important institution.	No.
14	Strengthen assessment of the enforceability of contracts.	Yes.
15	Advance legal certainty over rights to securities, cash, or collateral.	Yes.

continued on next page

Table 7.1 continuation

	Recommendation	Implemented
16	Recognize and support improved valuation methodologies and closeout netting arrangements.	No.
17	Ensure appointment of appropriately experienced and senior board members (of the boards of securities clearing and settlement infrastructure providers).	Yes.
18	Promote fair access to securities clearing and settlement networks.	Yes.
19	Ensure equitable and effective attention to stakeholder interests.	Yes.
20	Encourage consistent regulation and oversight of securities clearing and settlement service providers.	Yes.

BIC = Business Identification Code; CCP = Central Counterparty; CSD = Central Securities Depository; CDP = Central Depository Pte. Ltd.; ISIN = International Securities Identification Number; MAS = Monetary Authority of Singapore; MEPS+ = MAS Electronic Payment System; SWIFT = Society for Worldwide Interbank Financial Telecommunication; SGX = Singapore Exchange Securities Trading Limited
Source: Group of Thirty (G-30). 2003. *Global Clearing and Settlement – A Plan of Action*. <http://www.partad.ru/wrld/word/g30app1.pdf>

C. Group of Experts Final Report: Summary of Barriers Market Assessment (April 2010)

The GoE Report refers to the published results in 2010 of the Group of Experts (GoE) formed under Task Force 4 of the Asian Bond Market Initiative (ABMI). In the report, published under the leadership of the Asian Development Bank (ADB), a group of securities market experts from the private and public sector in ASEAN+3, as well as International Experts, assessed the ASEAN+3 securities markets on potential market barriers, the costs for cross-border bond transactions, and the feasibility for the establishment of a Regional Settlement Intermediary (RSI). The findings in the GoE Report lead to the creation of ABMF.

Table 7.2 Group of Experts Summary of Barriers Market Assessment – Singapore

Potential Barrier Area	Current Situation	Market Assessment Questionnaire Scores	Overall Barrier Assessment
Quotas	There are no quotas on foreign involvement in the local market.	OK	OK
Investor registration	There are no market entrance requirements for foreign investors. Nonresidents can invest in the SGD market without approval from the regulatory authorities.	OK	OK
FX controls - conversion	There are no exchange control restrictions on residents or non-residents. SGD is freely convertible.	OK	OK
FX controls - repatriation of funds	There is no restriction on the repatriation of funds.	OK	OK
Cash controls - credit balances	Non-residents may open accounts in SGD or in foreign currency. Credit balances are allowed. The rules have been progressively liberalised since 1998, and there are few remaining restrictions.	OK	OK
Cash controls - overdrafts	Overdrafts for non-resident accounts may be limited, but such restrictions do not apply to overdrafts due to securities settlement activity.	OK	OK
Taxes	Non-residents, including those with permanent establishment in Singapore, are exempt from withholding tax on QDS, provided that such securities were not purchased with funds resulting from a local business owned by the non-resident investor.	LOW	OK
Omnibus accounts	Omnibus accounts are allowed.	OK	OK
Settlement cycle	The settlement cycle for bonds is T+1 for government bonds (negotiable) and typically T+3 for corporate debt.	LOW	OK

continued on next page

Table 7.2 continuation

Potential Barrier Area	Current Situation	Market Assessment Questionnaire Scores	Overall Barrier Assessment
Message formats	Communications between market participants and depository or clearing house are in SWIFT format, for settlement of government bonds, and for settlement of corporate bonds via the DCSS. There are plans to progress to a SWIFT format in Phase 2 of the domestic pre-settlement matching system. Most local market participants use SWIFT.	OK	OK
Securities numbering	ISIN codes are available for all local bonds, and are available for new issues at issue date. The CSD and most local market participants use ISIN.	OK	OK
Matching	There are trade matching and pre-settlement matching systems for bonds.	OK	OK
Dematerialisation	Most bonds are dematerialised. However, some physical bonds are not immobilised at the CSD.	LOW	LOW
Regulatory framework	The regulatory regime is regarded as stable and consistent and no adverse comments were received in this area.	-	OK

CSD = Central Securities Depository; DCSS = Debt Securities Clearing and Settlement System; ISIN = International Securities Identification Number; QDS = qualifying debt securities; SGD = Singapore dollar; SWIFT = Society for Worldwide Interbank Financial Telecommunication
Source: Asian Development Bank. 2010. *Asian Bond Markets Initiative Group of Experts Final Report: Barriers to Cross-Border Investment and Settlement in the ASEAN+3 Bond Markets*. [https://wpqr1.adb.org/LotusQuickr/asean3goe/Main.nsf/h_58E34A1388F9070B48257729000C0A4E90F408746827C16248257729000C1334/\\$file/Part3.pdf](https://wpqr1.adb.org/LotusQuickr/asean3goe/Main.nsf/h_58E34A1388F9070B48257729000C0A4E90F408746827C16248257729000C1334/$file/Part3.pdf)

Appendixes

Appendix 1: PART XIII: Securities and Futures Act (SFA) 2001 (CHAPTER 289)

Box A1.1 Securities and Futures Act (SFA) 2001 (CHAPTER 289)

Securities and Futures Act (SFA) 2001 (CHAPTER 289)

2006 REVISED EDITION

PART XIII

OFFERS OF INVESTMENTS

Division 1—Shares and Debentures

Division 1—Shares and Debentures

SUBDIVISION (1)—Interpretation

- 239 Preliminary provisions
- 239A Authority may disapply this Division to certain offers
- 239B Modification of provisions to certain offers

SUBDIVISION (2)—PROSPECTUS REQUIREMENTS

- 240 Requirement for prospectus and profile statement, where relevant
- 240A Debenture issuance programme**
- 241 Lodging supplementary document or replacement document
- 242 Stop order for prospectus and profile statement
- 243 Contents of prospectus
- 244
- 245 Retention of over-subscriptions and statement of asset-backing in debenture issues
- 246 Contents of profile statement
- 247 **Exemption** from requirements as to form or content of prospectus or profile statement
- 248 **Exemption** for certain governmental and international entities as regards signing of copy of prospectus or profile statement by all directors or equivalent persons
- 249 Expert's consent to issue of prospectus or profile statement containing statement by him
- 249A Consent of issue manager and underwriter to being named in prospectus or profile statement
- 250 Duration of validity of prospectus and profile statement
- 251 Restrictions on advertisements, etc.

continued on next page

Box A1.1 continuation

- 252 Persons liable on prospectus or profile statement to inform person making offer about certain deficiencies
- 253 Criminal liability for false or misleading statements
- 254 Civil liability for false or misleading statements
- 255 Defences
- 256
- 257 Document containing offer of securities for sale deemed prospectus
- 258 Application and moneys to be held in trust in separate bank account until allotment
- 259 Allotment of securities where prospectus indicates application to list on securities exchange
- 260 Prohibition of allotment unless minimum subscription received

SUBDIVISION (3)—DEBENTURES

- 261 Preliminary provisions
- 262 Offer of asset-backed securities
- 263
- 264
- 265 Power of court in relation to certain irredeemable debentures
- 266 Duties of trustees**
- 267 Powers of trustee to apply to court for directions, etc.**
- 267A Right of Authority, securities exchange and holders of debentures to apply to court for order
- 268 Obligations of borrowing entity
- 269 Obligation of guarantor entity to furnish information
- 270 Loans and deposits to be immediately repayable on certain events
- 271 Liability of trustees for debenture holders

SUBDIVISION (4)—EXEMPTIONS

- 272 Issue or transfer of securities for no consideration
- 272A Small offers**
- 272B Private placement**
- 273 Offer made under certain circumstances**
- 274 Offer made to institutional investors**
- 275 Offer made to accredited investors and certain other persons**
- 276 Offer of securities acquired pursuant to section 274 or 275**
- 277 Offer made using offer information statement**
- 278 Offer in respect of international debentures**
- 279 Offer of debentures made by Government or international financial institutions
- 280 Making offer using automated teller machine or electronic means
- 281 Revocation of exemption
- 282 Transactions under exempted offers subject to Division 2 of Part XII of Companies Act and Part XII of this Act

DIVISION 1A—BUSINESS TRUSTS**SUBDIVISION (1)—INTERPRETATION**

- 282A Preliminary provisions
- 282B Division not to apply to certain business trusts which are collective investment schemes
- 282BA Modification of provisions to certain offers

SUBDIVISION (2)—PROSPECTUS REQUIREMENTS

- 282C Requirement for prospectus and profile statement, where relevant
- 282D Lodging supplementary document or replacement document
- 282E Stop order for prospectus and profile statement
- 282F Contents of prospectus
- 282G Contents of profile statement
- 282H Exemption from requirements as to form or content of prospectus or profile statement
- 282I Expert's consent to issue of prospectus or profile statement containing statement by him
- 282J Consent of issue manager and underwriter to being named in prospectus or profile statement
- 282K Duration of validity of prospectus and profile statement
- 282L Restrictions on advertisements, etc.
- 282M Persons liable on prospectus or profile statement to inform person making offer about certain deficiencies
- 282N Criminal liability for false or misleading statements
- 282O Civil liability for false or misleading statements
- 282P Defences

continued on next page

Box A1.1 continuation

- 282Q Document containing offer of units or derivatives of units for sale deemed prospectus
- 282R Application and moneys to be held in trust in separate bank account until allotment
- 282S Allotment of units or derivatives of units where prospectus indicates application to list on securities exchange
- 282T Prohibition of allotment unless minimum subscription received

SUBDIVISION (3)—EXEMPTIONS

- 282U Issue or transfer of units or derivatives of units for no consideration
- 282V Small offers
- 282W Private placement
- 282X Offer made under certain circumstances
- 282Y Offer made to institutional investors
- 282Z Offer made to accredited investors and certain other persons
- 282ZA Offer of securities acquired pursuant to section 282Y or 282Z
- 282ZAA Offer of units converted from debentures
- 282ZB Offer made using offer information statement
- 282ZC Making offer using automated teller machine or electronic means
- 282ZD Revocation of exemption
- 282ZE Transactions under exempted offers subject to Division 2 of Part XII of Companies Act and Part XII of this Act

SUBDIVISION (4)—DEBENTURES

- 282ZF Applicability of provisions relating to prospectus requirements

DIVISION 2—COLLECTIVE INVESTMENT SCHEMES**SUBDIVISION (1)—INTERPRETATION**

- 283 Interpretation of this Division
- 283A Use of term “real estate investment trust”
- 284 Code on Collective Investment Schemes
- 284A Authority may disapply this Division to certain offers and invitations
- 284B Division not to apply to certain collective investment schemes which are business trusts
- 284C Modification of provisions to certain offers

SUBDIVISION (2)—AUTHORISATION AND RECOGNITION

- 285 Requirement for authorisation or recognition
- 286 Authorised schemes
- 287 Recognised schemes
- 288 Revocation, suspension or withdrawal of authorisation or recognition
- 289 Approval of trustees**
- 290 Inspection of approved trustees**
- 291 Duty of trustees to furnish Authority with such return and information as Authority requires**
- 292 Liability of trustees**
- 293 Authority may issue directions
- 294 Service
- 295 Winding up
- 295A Power to acquire units of participants of real estate investment trust in certain circumstances
- 295B Unclaimed money to be paid to Official Receiver
- 295C Remedies in cases of oppression or injustice

SUBDIVISION (3)—PROSPECTUS REQUIREMENTS

- 296 Requirement for prospectus and profile statement, where relevant
- 297 Stop order for prospectus and profile statement
- 298 Lodging supplementary document or replacement document
- 299 Duration of validity of prospectus and profile statement
- 300 Restrictions on advertisements, etc.
- 301 Issue of units where prospectus indicates application to list on securities exchange
- 302 Application of provisions relating to securities

SUBDIVISION (4)—EXEMPTIONS

- 302A Issue or transfer for no consideration
- 302B Small offers
- 302C Private placement
- 303 Offer or invitation made under certain circumstances

continued on next page

Box A1.1 continuation

- 304 Offer made to institutional investors
- 304A First sale of units acquired pursuant to section 304
- 305 Offer made to accredited investors and certain other persons
- 305A First sale of units acquired pursuant to section 305
- 305B Offer made using offer information statement
- 305C Making offer using automated teller machine or electronic means
- 306 Power of Authority to exempt
- 307 Revocation of exemption
- 308 Transactions under exempted offers subject to Division 2 of Part XII of Companies Act and Part XII of this Act

DIVISION 3—SECURITIES HAWKING

- 309 Securities hawking prohibited

Preliminary provisions

239.—(1) In this Division—

“borrowing entity” means an entity that is or will be under a liability (whether or not such liability is present or future) to repay any money received by it in response to an invitation to subscribe for or purchase debentures of the entity;

“control”, in relation to an entity, means the capacity of a person to determine the outcome of decisions on the financial and operating policies of the entity, having regard to—

- (a) the influence which the person can, in practice, exert on the entity (as opposed to the rights which the person can exercise in the entity); and
 - (b) any practice or pattern of behaviour of the person affecting the financial or operating policies of the entity (even if such practice or pattern of behaviour involves a breach of an agreement or a breach of trust),
- but does not include any capacity of a person to influence decisions on the financial and operating policies of the entity if such influence is required by law or under any contract or order of court to be exercised for the benefit of other persons;

“debenture” includes debenture stock, bonds, notes and any other debt securities issued by a corporation or any other entity, whether or not constituting a charge on the assets of the issuer but does not include—

- (a) a cheque, letter of credit, order for the payment of money or bill of exchange;
- (b) subject to the regulations made under this Act, a promissory note having a face value of not less than \$100,000 and having a maturity period of not more than 12 months; or
- (c) for the purposes of the application of this definition to a provision of this Act in respect of which any regulations made thereunder provide that the word “debenture” does not include a prescribed document or a document included in a prescribed class of documents, that document or a document included in that class of documents, as the case may be;

“debenture issuance programme” means any scheme or arrangement by an entity for the issue of debentures or units of debentures where only part of the maximum amount or aggregate number of debentures or units of debentures under the programme is offered initially and a further tranche or tranches may be offered subsequently;

“expert” has the same meaning as in section 4 (1) of the Companies Act (Cap. 50);

“guarantor entity”, in relation to a borrowing entity, means an entity that has guaranteed or has agreed to guarantee the repayment of any money received or to be received by the borrowing entity in response to an invitation to subscribe for or purchase debentures of the borrowing entity;

“immediate family”, in relation to an individual, means the individual’s spouse, son, adopted son, step-son, daughter, adopted daughter, step-daughter, father, step-father, mother, step-mother, brother, step-brother, sister or step-sister;

“issuer”, in relation to an offer of securities, means the entity that issued or will be issuing the securities being offered;

“limited liability partnership” means any limited liability partnership whether registered in Singapore under the Limited Liability Partnerships Act (Cap. 163A) or otherwise;

“minimum subscription”, in relation to any securities offered for subscription, means the amount stated in the prospectus relating to the offer as the minimum amount which must be raised by the issue of the securities so offered, failing which no securities will be allotted or issued;

“preliminary document” means a document which has been lodged with the Authority and is issued for the purpose of determining the appropriate issue or sale price of, and the number of, securities to be issued or sold and which contains the information required to be included in a prospectus under

continued on next page

Box A1.1 continuation

section 243, except for such information as may be prescribed by the Authority;

“profile statement” means a profile statement referred to in section 240 (4);

“promoter”, in relation to a prospectus issued by or in connection with an entity, means a promoter of the entity who was a party to the preparation of the prospectus or of any relevant portion thereof, but does not include any person by reason only of his acting in a professional capacity;

“prospectus” means any prospectus, notice, circular, material, advertisement, publication or other document used to make an offer of securities, and includes any document deemed to be a prospectus under section 257, but does not include—

- (a) a profile statement; or
- (b) any material, advertisement or publication which is authorised by section 251 (other than subsection [5]);

“recognised securities exchange” means a corporation which has been declared by the Authority, by order published in the *Gazette*, to be a recognised securities exchange for the purposes of this Division;

“related party” means—

- (a) in relation to an entity—
 - (i) a director or an equivalent person of the entity;
 - (ii) the chief executive officer or equivalent person of the entity;
 - (iii) a person who controls the entity;
 - (iv) a related corporation;
 - (v) any other entity controlled by it;
 - (vi) any other entity controlled by the person referred to in sub-paragraph (iii); and
 - (vii) a related party of any individual referred to in sub-paragraph (i), (ii) or (iii); and

(b) in relation to an individual—

- (i) his immediate family;
- (ii) a trustee of any trust of which the individual or any member of the individual’s immediate family is—
 - (A) a beneficiary; or
 - (B) where the trust is a discretionary trust, a discretionary object, when the trustee acts in that capacity; and
- (iii) any corporation in which he and his immediate family (whether directly or indirectly) have interests in voting shares of an aggregate of not less than 30% of the total votes attached to all voting shares;

“replacement document” means a replacement prospectus or a replacement profile statement referred to in section 241 (1), as the case may be;

“securities” means—

- (a) shares or units of shares of a corporation;
- (b) debentures or units of debentures of an entity;
- (c) interests in a limited partnership or limited liability partnership formed in Singapore or elsewhere; or
- (d) such other product or class of products as the Authority may prescribe, but does not include such other product or class of products as the Authority may prescribe as not being securities;

“statutory meeting” has the same meaning as in section 4 (1) of the Companies Act (Cap. 50);

“supplementary document” means a supplementary prospectus or a supplementary profile statement referred to in section 241 (1), as the case may be;

“underlying entity”, in relation to an offer of units of shares or debentures, means the entity the shares or debentures of which are the subject of the offer;

“unit”, in relation to a share or debenture, means any right or interest, whether legal or equitable, in the share or debenture, by whatever name called, and includes any option to acquire any such right or interest in the share or debenture.

[16/2003; 31/2004;1/2005]

(2) For the purposes of this Division, a statement shall be deemed to be included in a prospectus or profile statement if it is contained in any report or memorandum appearing on the face thereof or by reference incorporated therein or issued therewith.

(3) For the purposes of this Division—

- (a) any invitation to a person to deposit money with or to lend money to an entity shall be deemed to be an offer of debentures of the entity; and
- (b) any document that is issued or intended or required to be issued by an entity acknowledging or evidencing or constituting an acknowledgment of the indebtedness of the entity in respect of any money that is or may be deposited with or lent to the entity in response to such an invitation shall be deemed to be a debenture.

continued on next page

Box A1.1 continuation

- [1/2005]
- (3A) Notwithstanding subsection (3)—
- (a) any invitation to a person by a prescribed entity to make a deposit with the prescribed entity is not an offer of debentures; and
- (b) the following documents issued or intended or required to be issued by a prescribed entity are not debentures:
- (i) any certificate of deposit;
- (ii) any other document acknowledging or evidencing or constituting an acknowledgment of the indebtedness of the prescribed entity in respect of any deposit that is or may be made with the prescribed entity.
- [1/2005]
- (4) In subsections (3A) and (5)—
- “deposit” has the same meaning as in section 4B (4) of the Banking Act (Cap. 19);
- “prescribed entity” means—
- (a) any bank licensed under the Banking Act; or
- (b) any entity or any entity of a class which has been declared by the Authority, by order published in the *Gazette*, to be a prescribed entity for the purposes of this subsection.
- [1/2005]
- (5) The Authority may, by notice in writing—
- (a) impose such conditions or restrictions on a prescribed entity as it thinks fit; and
- (b) at any time vary or revoke any condition or restriction so imposed,
- and the prescribed entity shall comply with every such condition or restriction imposed on it by the Authority that has not been revoked by the Authority.
- [1/2005]
- (5A) Any person who contravenes any condition or restriction imposed under subsection (5) shall be guilty of an offence and shall be liable on conviction to a fine not exceeding \$50,000 and, in the case of a continuing offence, to a further fine not exceeding \$5,000 for every day or part thereof during which the offence continues after conviction.
- [1/2005]
- (6) For the purposes of this Division, a person makes an offer of any securities if, and only if, as principal—
- (a) he makes (either personally or by an agent) an offer to any person in Singapore which upon acceptance would give rise to a contract for the issue or sale of those securities by him or another person with whom he has made arrangements for that issue or sale; or
- (b) he invites (either personally or by an agent) any person in Singapore to make an offer which upon acceptance would give rise to a contract for the issue or sale of those securities by him or another person with whom he has made arrangements for that issue or sale.
- [1/2005]
- (7) In subsection (6), “sale” includes any disposal for valuable consideration.
- [1/2005]
- (8) This Division applies only in relation to offers of securities made on or after the commencement of this Division.
- [1/2005]

*[Companies, s. 4]***Authority may disapply this Division to certain offers**

239A. Notwithstanding any provision to the contrary in this Division, where—

- (a) an offer of securities is one to which (but for this section) both this Division and Division 2 apply; and
- (b) the Authority has by order published in the *Gazette* declared that this Division shall not apply to that offer or a class of offers to which that offer belongs, then this Division shall not apply to that offer.
- [1/2005]

Modification of provisions to certain offers

239B. The Authority may, if it thinks it necessary in the interest of the public or a section of the public or for the protection of investors, by regulations modify or adapt the provisions of this Division in their application to such offer of securities as may be prescribed, and the provisions of this Division shall apply to such offer subject to such modifications or adaptations.

Subdivision (2)—Prospectus requirements**Requirement for prospectus and profile statement, where relevant**

240.—(1) No person shall make an offer of securities unless the offer—

- (a) is made in or accompanied by a prospectus in respect of the offer—
- (i) that is prepared in accordance with section 243;
- (ii) a copy of which, being one that has been signed in accordance with subsection (4A), is lodged with the Authority; and
- (iii) that is registered by the Authority; and
- (b) complies with such requirements as may be prescribed by the Authority.
- [16/2003;1/2005]

(2) A person who lodges a preliminary document with the Authority shall be deemed to have lodged a prospectus with the Authority.

(3) A preliminary document referred to in subsection (2) must contain all information to be included in a prospectus other than such information as may be prescribed by the Authority.

continued on next page

Box A1.1 continuation

- (4) Notwithstanding subsection (1), an offer of securities may be made in or accompanied by an extract from, or an abridged version of, a prospectus (referred to in this section as a profile statement), instead of a prospectus, if—
- (a) a prospectus in respect of such offer is prepared in accordance with section 243, and the profile statement is prepared in accordance with section 246;
 - (b) a copy of the prospectus and a copy of the profile statement, each of which has been signed in accordance with subsection (4A), are lodged with the Authority, and the prospectus is lodged no later than the profile statement;
 - (c) the prospectus and profile statement are registered by the Authority;
 - (d) sufficient copies of the prospectus are made available for collection at the times and places specified in the profile statement; and
 - (e) the offer complies with such requirements as may be prescribed by the Authority.

[16/2003;1/2005]

(4A) The copy of a prospectus or profile statement lodged with the Authority shall be signed—

- (a) where the person making the offer is the issuer—
 - (i) in a case where the issuer is not the government of a State, by every director or equivalent person of the issuer and every person who is named therein as a proposed director or an equivalent person of the issuer; or
 - (ii) in a case where the issuer is the government of a State, by an official of that government who is authorised to sign the prospectus on its behalf;
- (b) where the person making the offer is an individual and is not the issuer—
 - (i) in a case where the issuer is not the government of a State—
 - (A) by that person; and
 - (B) if the issuer is controlled by that person, one or more of his related parties, or that person and one or more of his related parties, by every director or equivalent person of the issuer and every person who is named therein as a proposed director or an equivalent person of the issuer; or
 - (ii) in a case where the issuer is the government of a State, by that person;
- (c) where the person making the offer is an entity (not being the government of a State) and is not the issuer—
 - (i) in a case where the issuer is not the government of a State—
 - (A) by every director or equivalent person of that entity; and
 - (B) if the issuer is controlled by that entity, one or more of its related parties, or that entity and one or more of its related parties, by every director or equivalent person of the issuer, and every person who is named therein as a proposed director or an equivalent person of the issuer; or
 - (ii) in a case where the issuer is the government of a State, by every director or equivalent person of that entity; and
- (d) where the person making the offer is the government of a State and is not the issuer—
 - (i) in a case where the issuer is not the government of another State—
 - (A) by an official of the government of the State who is authorised to sign the prospectus on its behalf; and
 - (B) if the issuer is controlled by that government, one or more of its related parties, or that government and one or more of its related parties, by every director or every equivalent person of the issuer, and every person who is named therein as a proposed director or an equivalent person of the issuer; or
 - (ii) in a case where the issuer is the government of another State, by an official of the government of the first-mentioned State who is authorised to sign the prospectus on its behalf.

[1/2005]

(4B) A requirement under subsection (4A) for the copy of a prospectus or profile statement to be signed by a director or an equivalent person is satisfied if the copy is signed—

- (a) by that director or equivalent person; or
- (b) by a person who is authorised in writing by that director or equivalent person to sign on his behalf.

[1/2005]

(4C) A requirement under subsection (4A) for the copy of a prospectus or profile statement to be signed by a person named therein as a proposed director or an equivalent person is satisfied if the copy is signed—

- (a) by that proposed director or equivalent person; or
- (b) by a person who is authorised in writing by that proposed director or equivalent person to sign on his behalf.

[1/2005]

(5) No person shall make any offer of securities of an entity that has not been formed or does not exist.

[1/2005]

(6) *(Deleted by Act 1/2005)*

(7) Any person who contravenes subsection (1) or (5) shall be guilty of an offence and shall be liable on conviction to a fine not exceeding \$150,000 or to imprisonment for a term not exceeding 2 years or to both and, in the case of a continuing offence, to a further fine not exceeding \$15,000 for every day or part thereof during which the offence continues after conviction.

(8) The Authority may register a prospectus or a profile statement on any day within the period prescribed by the Authority from the date of lodgment thereof with the Authority, unless—

- (a) the Authority gives to the person making the offer a notice of an opportunity to be heard under subsection (15);
- (b) the Authority gives to the person making the offer a notice of an extension, in which case the Authority may, not later than 28 days from the date of lodgment of the prospectus or profile statement—
 - (i) register the prospectus or profile statement; or
 - (ii) give the person making the offer a notice of an opportunity to be heard under subsection (15);
- (c) the person making the offer applies in writing to extend the period during which the prospectus or profile statement may be registered, and the Authority grants an extension as it thinks fit, in which case the Authority may, at any time up to and including the date on which the extended period ends—

continued on next page

Box A1.1 continuation

- (i) register the prospectus or profile statement; or
- (ii) give the person making the offer a notice of an opportunity to be heard under subsection (15); or
- (d) the person making the offer gives a notice in writing to the Authority to withdraw the lodgment of the prospectus or profile statement, in which case the Authority shall not register the prospectus or profile statement.

[1/2005]

(8A) Where, after a notice of an opportunity to be heard has been given under subsection (8) (a), (b) (ii) or (c) (ii), the Authority decides not to refuse registration of the prospectus or profile statement, the Authority may proceed with the registration on such date as it considers appropriate, except that that date shall not be earlier than such day from the date of lodgment of the prospectus or profile statement with the Authority as the Authority may prescribe.

[1/2005]

(8B) For the purposes of subsections (8) and (8A), the Authority may prescribe the same period and day for all offers or different periods and days for different offers.

(9) Where a prospectus lodged with the Authority is a preliminary document, the Authority shall not register the prospectus unless a copy of the prospectus which has been signed in accordance with subsection (4A) and which contains the information required to be stipulated in the prospectus under section 243, including such information which could be omitted from the preliminary document by virtue of subsection (3), has been lodged with the Authority.

[1/2005]

(9A) A person making an offer of securities may lodge any amendment to a prospectus or profile statement in respect of that offer at any time before, but not after, the registration of the prospectus or profile statement by the Authority.

[1/2005]

(10) Subject to subsection (11)—

- (a) where any amendment to a prospectus is lodged, the prospectus and any profile statement which is lodged shall be deemed for the purposes of subsection (8) to have been lodged when such amendment was lodged; and
- (b) where any amendment to a profile statement is lodged, the profile statement shall be deemed for the purposes of subsection (8) to have been lodged when such amendment was lodged.

[16/2003;1/2005]

(11) Where an amendment to a prospectus or profile statement is lodged with the consent of the Authority, the prospectus or profile statement as amended shall be deemed, for the purposes of subsection (8), to have been lodged when the original prospectus or profile statement was lodged with the Authority.

[1/2005]

(11A) An amendment to a prospectus or profile statement that is lodged shall be treated as part of the original prospectus or profile statement.

[16/2003]

(12) The Authority may, for public information, publish—

- (a) a prospectus or profile statement lodged with the Authority under this section; and
- (b) where applicable, the translation thereof in the English language lodged with the Authority under section 318A (1), and, for the purposes of this subsection, the person making the offer shall provide the Authority with a copy of the prospectus or profile statement and, where applicable, the translation in such form or medium for publication as the Authority may require.

[16/2003;1/2005]

(13) The Authority shall refuse to register a prospectus if—

- (a) the Authority is of the opinion that the prospectus contains a false or misleading statement;
- (b) there is an omission from the prospectus of any information that is required to be included in it under section 243;
- (c) the copy of the prospectus that is lodged with the Authority is not signed in accordance with subsection (4A);
- (d) the Authority is of the opinion that the prospectus does not comply with the requirements of this Act;
- (e) any written consent of an expert to the issue of the prospectus required under section 249, or a copy thereof which is verified as prescribed, is not lodged with the Authority;
- (ea) any written consent of an issue manager to the issue of the prospectus required under section 249A (1), or a copy thereof which is verified as prescribed, is not lodged with the Authority;
- (eb) any written consent of an underwriter to the issue of the prospectus required under section 249A (2), or a copy thereof which is verified as prescribed, is not lodged with the Authority; or
- (f) the Authority is of the opinion that it is not in the public interest to do so.

[16/2003;1/2005]

(14) The Authority shall refuse to register a profile statement if—

- (a) the Authority is of the opinion that the profile statement contains a false or misleading statement;
- (b) there is an omission from the profile statement of information required by section 246 to be included in it or an inclusion in the profile statement of information prohibited by that section from being included in it;
- (c) the copy of the profile statement that is lodged with the Authority is not signed in accordance with subsection (4A);
- (ca) any written consent of an expert to the issue of the profile statement required under section 249, or a copy thereof which is verified as prescribed, is not lodged with the Authority;
- (cb) any written consent of an issue manager to the issue of the profile statement required under section 249A (1), or a copy thereof which is verified as prescribed, is not lodged with the Authority;
- (cc) any written consent of an underwriter to the issue of the profile statement required under section 249A (2), or a copy thereof which is verified as prescribed, is not lodged with the Authority;

continued on next page

Box A1.1 continuation

- (d) the Authority is of the opinion that the profile statement does not comply with the requirements of this Act;
 (e) the prospectus has not been registered by the Authority; or
 (f) the Authority is of the opinion that it is not in the public interest to do so.

[16/2003;1/2005]

(15) The Authority shall not refuse to register a prospectus under subsection (13) or a profile statement under subsection (14) without giving the person making the offer an opportunity to be heard, except that an opportunity to be heard need not be given if the refusal is on the ground that it is not in the public interest to register the prospectus or profile statement on the basis of any of the following circumstances:

- (a) the person making the offer (being an entity), the issuer or, where applicable, the underlying entity is in the course of being wound up or otherwise dissolved, whether in Singapore or elsewhere;
 (b) the person making the offer (being an individual) is an undischarged bankrupt, whether in Singapore or elsewhere;
 (c) a receiver, a receiver and manager or an equivalent person has been appointed, whether in Singapore or elsewhere, in relation to or in respect of any property of the person making the offer (being an entity), the issuer or, where applicable, the underlying entity.

[1/2005]

(16) Any person making an offer may, within 30 days after he is notified that the Authority has refused to register a prospectus or profile statement to which his offer relates under subsection (13) or (14), appeal to the Minister, whose decision shall be final.

[1/2005]

(17) If—

- (a) a prospectus or profile statement is issued, circulated or distributed before it has been registered by the Authority; or
 (b) an application to subscribe for or purchase securities is accepted, or securities are allotted, issued or sold, before a prospectus and, where applicable, profile statement in respect of the securities has been registered by the Authority,
 the person making the offer and every person who is knowingly a party to—
 (i) the issue, circulation or distribution of the prospectus or profile statement;
 (ii) the acceptance of the application to subscribe for or purchase the securities; or
 (iii) the allotment, issue or sale of the securities,

as the case may be, shall be guilty of an offence and shall be liable on conviction to a fine not exceeding \$150,000 or to imprisonment for a term not exceeding 2 years or to both and, in the case of a continuing offence, to a further fine not exceeding \$15,000 for every day or part thereof during which the offence continues after conviction.

[1/2005]

(18) This section is subject to section 240A.

[1/2005]

(19) For the purposes of subsections (13) (a) and (14) (a), any reference to a statement shall include a reference to any information presented, regardless of whether such information is in text or otherwise.

[1/2005]

(20) Regulations made under this section may provide that a contravention of specified provisions thereof shall be an offence and may provide penalties not exceeding a fine of \$50,000.

[Companies, s. 43, s. 45A and s. 50; Aust. Corporations 2001, s. 721]

Debenture issuance programme

240A.—(1) A prospectus for every offer of debentures or units of debentures that is part of a debenture issuance programme shall comprise—

- (a) a base prospectus applicable to every offer under the debenture issuance programme; and
 (b) a pricing statement applicable to that particular offer.

[1/2005]

(2) A profile statement for every offer of debentures or units of debentures that is part of a debenture issuance programme shall comprise—

- (a) an extract from, or an abridged version of, a base prospectus referred to in subsection (1) (a) (referred to in this section as a base profile statement); and
 (b) a pricing statement applicable to that particular offer.

[1/2005]

(3) In respect of an offer referred to in subsection (1), the requirements of section 240 (1) (a) (ii) and (iii) are satisfied if a copy of the base prospectus and a copy of the pricing statement, each of which is signed in accordance with section 240 (4A), have been lodged with and registered by the Authority, either separately, whether on the same date or on different dates, or as a single document.

[1/2005]

(4) In respect of an offer referred to in subsection (2), the requirements of section 240 (4) (b) and (c) are satisfied if a copy of the base profile statement and a copy of the pricing statement, each of which is signed in accordance with section 240 (4A), have been lodged with and registered by the Authority, either separately, whether on the same date or on different dates, or as a single document.

[1/2005]

(5) For the avoidance of doubt, where the base prospectus or base profile statement in relation to a debenture issuance programme has been lodged with and registered by the Authority, it shall be treated as having been lodged with and registered by the Authority in respect of every offer under that programme.

[1/2005]

(6) For the purposes of the application of the provisions of this Subdivision to an offer referred to in subsection (1), a reference to a prospectus shall, unless the context otherwise requires or the Authority has prescribed otherwise, be read as a reference to both the base prospectus and the pricing statement.

continued on next page

Box A1.1 continuation

(7) For the purposes of the application of the provisions of this Subdivision to an offer referred to in subsection (2), a reference to a profile statement shall, unless the context otherwise requires or the Authority has prescribed otherwise, be read as a reference to both the base profile statement and the pricing statement. [1/2005]

(8) The Authority may, by regulations, prescribe how the provisions of this Subdivision shall apply to an offer referred to in subsection (1) or (2). [1/2005]

(9) For the avoidance of doubt, a pricing statement may be registered by the Authority at any time after its lodgment with the Authority. [1/2005]

Lodging supplementary document or replacement document

241.—(1) If, after a prospectus or profile statement is registered but before the close of the offer of securities, the person making that offer becomes aware of—

- (a) a false or misleading statement in the prospectus or profile statement;
- (b) an omission from the prospectus of any information that should have been included in it under section 243, or an omission from the profile statement of any information that should have been included in it under section 246, as the case may be; or
- (c) a new circumstance that—
 - (i) has arisen since the prospectus or profile statement was lodged with the Authority; and
 - (ii) would have been required by—
 - (A) section 243 to be included in the prospectus; or
 - (B) section 246 to be included in the profile statement,

if it had arisen before the prospectus or the profile statement, as the case may be, was lodged, and that is materially adverse from the point of view of an investor, the person may lodge a supplementary or replacement prospectus, or a supplementary or replacement profile statement (referred to in this section as a supplementary or replacement document, as the case may be), with the Authority.

(1A) If, after a base prospectus or a base profile statement referred to in section 240A is registered but before the expiration of 24 months from the registration of the base prospectus by the Authority, the person making that offer intends to update any information or include any new information in the base prospectus or base profile statement, the person may lodge a supplementary or replacement document with the Authority, provided that no offer to which the base prospectus or base profile statement relates is subsisting at the time of the lodgment. [16/2003;1/2005]

(1B) Subsections (7) to (16) shall not apply to a supplementary or replacement document which is lodged under subsection (1A). [1/2005]

(1C) For the purposes of subsection (1A), an offer shall not be treated as subsisting if—

- (a) a pricing statement in respect of the offer of debentures or units of debentures has not been registered by the Authority under section 240A; or
- (b) a pricing statement in respect of the offer of debentures or units of debentures has been registered by the Authority under section 240A, and—
 - (i) the offer has closed with no application to subscribe for or purchase the debentures or units of debentures having been received or accepted; or
 - (ii) one or more applications to subscribe for or purchase the debentures or units of debentures have been received or accepted, and—
 - (A) in a case where the debentures or units of debentures are or will be listed for quotation on a securities exchange, trading in them has commenced; or
 - (B) in any other case, all of those debentures or units of debentures have been issued or sold.

 [1/2005]

(2) At the beginning of a supplementary document, there shall be—

- (a) a statement that it is a supplementary prospectus or a supplementary profile statement, as the case may be;
- (b) an identification of the prospectus or profile statement it supplements;
- (c) an identification of any previous supplementary document lodged with the Authority in relation to the offer; and
- (d) a statement that it is to be read together with the prospectus or profile statement it supplements and any previous supplementary document in relation to the offer.

 [1/2005]

(3) At the beginning of a replacement document, there shall be—

- (a) a statement that it is a replacement prospectus or a replacement profile statement, as the case may be; and
- (b) an identification of the prospectus or profile statement it replaces.

 (4) The supplementary document and the replacement document must be dated with the date on which they are lodged with the Authority.
 (5) The person making the offer shall take reasonable steps—

- (a) to inform potential investors of the lodgment of any supplementary or replacement document under subsection (1) or (1A); and
- (b) to make available to them the supplementary document or replacement document.

 [1/2005]

(6) For the purposes of the application of this Division to events that occur after the lodgment of the supplementary document—

- (a) where the supplementary document is a supplementary prospectus, the prospectus in relation to the offer shall be taken to be the original prospectus together with the supplementary prospectus and any previous supplementary prospectus in relation to the offer; and
- (b) where the supplementary document is a supplementary profile statement, the profile statement in relation to the offer shall be taken to be the original profile statement together with the supplementary profile statement and any previous supplementary profile statement in relation to the offer.

 [16/2003;1/2005]

continued on next page

Box A1.1 continuation

(6A) *(Deleted by Act 1/2005)*

(6B) For the purposes of the application of this Division to events that occur after the lodgment of the replacement document—

(a) where the replacement document is a replacement prospectus, the prospectus in relation to the offer shall be taken to be the replacement prospectus; and

(b) where the replacement document is a replacement profile statement, the profile statement in relation to the offer shall be taken to be the replacement profile statement.

[16/2003;1/2005]

(7) If a supplementary document or replacement document is lodged with the Authority, the offer shall be kept open for at least 14 days after the lodgment of the supplementary document or replacement document.

[1/2005]

(8) Where, prior to the lodgment of the supplementary document or replacement document, applications have been made under the original prospectus or profile statement to subscribe for securities, then—

(a) where the securities have not been issued to the applicants, the person making the offer—

(i) shall—

(A) within 2 days (excluding any Saturday, Sunday or public holiday) from the date of lodgment of the supplementary document or replacement document, give the applicants notice in writing of how to obtain, or arrange to receive, a copy of the supplementary document or replacement document, as the case may be, and provide the applicants with an option to withdraw their applications; and

(B) take all reasonable steps to make available within a reasonable period the supplementary document or replacement document, as the case may be, to the applicants who have indicated that they wish to obtain, or who have arranged to receive, a copy of the supplementary document or replacement document;

(ii) shall, within 7 days from the date of lodgment of the supplementary document or replacement document, give the applicants the supplementary document or replacement document, as the case may be, and provide the applicants with an option to withdraw their applications; or

(iii) shall—

(A) treat the applications as withdrawn and cancelled, in which case the applications shall be deemed to have been withdrawn and cancelled; and

(B) within 7 days from the date of lodgment of the supplementary document or replacement document, pay to the applicants all moneys the applicants have paid on account of their applications for the securities; or

(b) where the securities have been issued to the applicants, the person making the offer—

(i) shall—

(A) within 2 days (excluding any Saturday, Sunday or public holiday) from the date of lodgment of the supplementary document or replacement document, give the applicants notice in writing of how to obtain, or arrange to receive, a copy of the supplementary document or replacement document, as the case may be, and provide the applicants with an option to return, to the person making the offer, those securities which they do not wish to retain title in; and

(B) take all reasonable steps to make available within a reasonable period the supplementary document or replacement document, as the case may be, to the applicants who have indicated that they wish to obtain, or who have arranged to receive, a copy of the supplementary document or replacement document;

(ii) shall, within 7 days from the date of lodgment of the supplementary document or replacement document, give the applicants the supplementary document or replacement document, as the case may be, and provide the applicants with an option to return, to the person making the offer, those securities which they do not wish to retain title in; or

(iii) shall—

(A) treat the issue of the securities as void, in which case the issue shall be deemed void; and

(B) within 7 days from the date of lodgment of the supplementary document or replacement document, pay to the applicants all moneys paid by them for the securities.

[1/2005]

(9) Subsections (8) (b) and (11) have effect notwithstanding sections 76 and 76A, and Division 3A of Part IV, of the Companies Act (Cap. 50).

[42/2005]

(10) An applicant who wishes to exercise his option under subsection (8) (a) (i) or (ii) to withdraw his application shall, within 14 days from the date of lodgment of the supplementary document or replacement document, notify the person making the offer of this, whereupon that person shall, within 7 days from the receipt of such notification, pay to the applicant all moneys paid by the applicant on account of his application for the securities.

[1/2005]

(11) An applicant who wishes to exercise his option under subsection (8) (b) (i) or (ii) to return securities issued to him shall, within 14 days from the date of lodgment of the supplementary document or replacement document, notify the person making the offer of this and return all documents, if any, purporting to be evidence of title to those securities to that person, whereupon that person shall, within 7 days from the receipt of such notification and documents, if any, pay to the applicant all moneys paid by the applicant for the securities, and the issue of those securities shall be deemed to be void.

[1/2005]

(12) Where, prior to the lodgment of the supplementary document or replacement document, applications have been made under the original prospectus or profile statement to purchase securities, then—

(a) where the securities have not been transferred to the applicants, the person making the offer—

(i) shall—

(A) within 2 days (excluding any Saturday, Sunday or public holiday) from the date of lodgment of the supplementary document or replacement document, give the applicants notice in writing of how to obtain, or arrange to receive, a copy of the supplementary document or replacement document, as the case may be, and provide the applicants with an option to withdraw their applications; and

continued on next page

Box A1.1 continuation

(B) take all reasonable steps to make available within a reasonable period the supplementary document or replacement document, as the case may be, to the applicants who have indicated that they wish to obtain, or who have arranged to receive, a copy of the supplementary document or replacement document;

(ii) shall, within 7 days from the date of lodgment of the supplementary document or replacement document, give the applicants the supplementary document or replacement document, as the case may be, and provide the applicants with an option to withdraw their applications; or

(iii) shall—

(A) treat the applications as withdrawn and cancelled, in which case the applications shall be deemed to have been withdrawn and cancelled; and

(B) within 7 days from the date of lodgment of the supplementary document or replacement document, pay to the applicants all moneys the applicants have paid on account of their applications for the securities; or

(b) where the securities have been transferred to the applicants, the person making the offer—

(i) shall—

(A) within 2 days (excluding any Saturday, Sunday or public holiday) from the date of lodgment of the supplementary document or replacement document, give the applicants notice in writing of how to obtain, or arrange to receive, a copy of the supplementary document or replacement document, as the case may be, and provide the applicants with an option to return, to the person making the offer, those securities which they do not wish to retain title in; and

(B) take all reasonable steps to make available within a reasonable period the supplementary document or replacement document, as the case may be, to the applicants who have indicated that they wish to obtain, or who have arranged to receive, a copy of the supplementary document or replacement document;

(ii) shall, within 7 days from the date of lodgment of the supplementary document or replacement document, give the applicants the supplementary document or replacement document, as the case may be, and provide the applicants with an option to return, to the person making the offer, those securities which they do not wish to retain title in; or

(iii) shall treat the sale of the securities as void, in which case the sale shall be deemed void, and shall—

(A) if documents purporting to evidence title to the securities (referred to in this paragraph as the title documents) have been issued to the applicants—

(AA) within 7 days from the date of lodgment of the supplementary document or replacement document, inform the applicants to return the title documents to the person making the offer within 14 days from the date of lodgment of the supplementary document or replacement document; and

(AB) within 7 days from the date of receipt of the title documents or the date of lodgment of the supplementary document or replacement document, whichever is the later, pay to the applicants all moneys paid by them for the securities; or

(B) if no title documents have been issued to the applicants, within 7 days from the date of the lodgment of the supplementary document or replacement document, pay to the applicants all moneys paid by them for the securities.

[1/2005]

(13) An applicant who wishes to exercise his option under subsection (12) (a) (i) or (ii) to withdraw his application shall, within 14 days from the date of lodgment of the supplementary document or replacement document, notify the person making the offer of this, whereupon that person shall, within 7 days of the receipt of such notification, pay to the applicant all moneys paid by him on account of his application for the securities.

[1/2005]

(14) An applicant who wishes to exercise his option under subsection (12) (b) (i) or (ii) to return securities sold to him shall, within 14 days from the date of lodgment of the supplementary document or replacement document, notify the person making the offer of this and return all documents, if any, purporting to evidence title to those securities to the person making the offer, whereupon that person shall, within 7 days from the receipt of such notification and documents, if any, pay to the applicant all moneys paid by him for the securities and the sale of the securities shall be deemed to be void.

[1/2005]

(15) Any person who contravenes subsection (8) or (12) shall be guilty of an offence and shall be liable on conviction to a fine not exceeding \$100,000 and, in the case of a continuing offence, to a further fine not exceeding \$10,000 for every day or part thereof during which the offence continues after conviction.

(16) Any person who contravenes any other provision of this section shall be guilty of an offence and shall be liable on conviction to a fine not exceeding \$50,000 and, in the case of a continuing offence, to a further fine not exceeding \$5,000 for every day or part thereof during which the offence continues after conviction.

(17) For the purposes of subsection (1) (a), the reference to a statement shall include a reference to any information presented, regardless of whether such information is in text or otherwise.

[1/2005]

[Companies, s. 50A ; Aust. Corporations 2001, s. 719]

Stop order for prospectus and profile statement

242.—(1) If a prospectus has been registered and—

(a) the Authority is of the opinion that the prospectus contains a false or misleading statement;

(b) there is an omission from the prospectus of any information that is required to be included in it under section 243;

(c) the Authority is of the opinion that the prospectus does not comply with the requirements of this Act; or

(d) the Authority is of the opinion that it is in the public interest to do so,

the Authority may by an order in writing (referred to in this section as a stop order) served on the person making the offer of securities to which the prospectus relates direct that no or no further securities be allotted, issued or sold.

[16/2003;1/2005]

(2) If a profile statement has been registered and—

continued on next page

Box A1.1 continuation

(a) the Authority is of the opinion that the profile statement contains a false or misleading statement;
 (b) there is an omission from the profile statement of any information that is required to be included in it under section 246;
 (c) the Authority is of the opinion that the profile statement does not comply with the requirements of this Act; or
 (d) the Authority is of the opinion that it is in the public interest to do so,
 the Authority may by an order in writing (referred to in this section as a stop order) served on the person making the offer of securities to which the profile statement relates direct that no or no further securities be allotted, issued or sold.

[16/2003;1/2005]

(3) Notwithstanding subsections (1) and (2), the Authority shall not serve a stop order if any of the securities to which the prospectus or profile statement relates has been issued or sold, and listed for quotation on a securities exchange and trading in them has commenced.

[1/2005]

(4) The Authority shall not serve a stop order under subsection (1) or (2) without giving the person making the offer an opportunity to be heard, except that an opportunity to be heard need not be given if the stop order is served on the ground that it is in the public interest to do so on the basis of any of the following circumstances:

(a) the person making the offer (being an entity), the issuer or, where applicable, the underlying entity is in the course of being wound up or otherwise dissolved, whether in Singapore or elsewhere;

(aa) the person making the offer (being an individual) is an undischarged bankrupt, whether in Singapore or elsewhere;

(b) a receiver, a receiver and manager or an equivalent person has been appointed, whether in Singapore or elsewhere, in relation to or in respect of any property of the person making the offer (being an entity), the issuer or, where applicable, the underlying entity.

[16/2003;1/2005]

(5) Where applications to subscribe for securities to which the prospectus or profile statement relates have been made prior to the stop order, then—

(a) where the securities have not been issued to the applicants—

(i) the applications shall be deemed to have been withdrawn and cancelled; and

(ii) the person making the offer shall, within 14 days from the date of the stop order, pay to the applicants all moneys the applicants have paid on account of their applications for the securities; or

(b) where the securities have been issued to the applicants—

(i) the issue of the securities shall be deemed to be void; and

(ii) the person making the offer shall, within 14 days from the date of the stop order, pay to the applicants all moneys paid by them for the securities.

[1/2005]

(6) Subsection (5) (b) has effect notwithstanding sections 76 and 76A, and Division 3A of Part IV, of the Companies Act (Cap. 50).

[42/2005]

(7) Where applications to purchase securities to which the prospectus or profile statement relates have been made prior to the stop order, then—

(a) where the securities have not been transferred to the applicants—

(i) the applications shall be deemed to have been withdrawn and cancelled; and

(ii) the person making the offer shall, within 14 days from the date of the stop order, pay to the applicants all moneys the applicants have paid on account of their applications for the securities; or

(b) where the securities have been transferred to the applicants, the sale shall be deemed to be void, and the person making the offer shall—

(i) if documents purporting to evidence title to the securities have been issued to the applicants—

(A) within 7 days from the date of the stop order, inform the applicants to return such documents to the person making the offer within 14 days from that date; and

(B) within 7 days from the date of the receipt of those documents or the date of the stop order, whichever is the later, pay to the applicants all moneys paid by them for the securities; or

(ii) if no such documents have been issued to the applicants, within 7 days from the date of the stop order, pay to the applicants all moneys paid by them for the securities.

[1/2005]

(8) If the Authority is of the opinion that any delay in serving a stop order pending the holding of a hearing required under subsection (4) is not in the interests of the public, the Authority may, without giving an opportunity to be heard, serve an interim stop order on the person making the offer directing that no or no further securities to which the prospectus or profile statement relates be allotted, issued or sold.

[1/2005]

(9) An interim stop order shall, unless revoked by the Authority, be in force—

(a) in a case where—

(i) it is served during a hearing under subsection (4); or

(ii) a hearing under subsection (4) is commenced while it is in force, until the Authority makes an order under subsection (1) or (2); and

(b) in any other case, for a period of 14 days from the day on which the interim stop order is served.

[16/2003]

(10) Subsections (5) and (7) shall not apply where only an interim stop order has been served.

(11) Any person who fails to comply with a stop order served under subsection (1) or (2) or an interim stop order served under subsection (8) shall be guilty of an offence and shall be liable on conviction to a fine not exceeding \$150,000 or to imprisonment for a term not exceeding 2 years or to both and, in the case of a continuing offence, to a further fine not exceeding \$15,000 for every day or part thereof during which the offence continues after conviction.

(12) Any person who contravenes subsection (5) or (7) shall be guilty of an offence and shall be liable on conviction to a fine not exceeding \$100,000

continued on next page

Box A1.1 continuation

and, in the case of a continuing offence, to a further fine not exceeding \$10,000 for every day or part thereof during which the offence continues after conviction.

(13) For the purposes of subsections (1) (a) and (2) (a), any reference to a statement shall include a reference to any information presented, regardless of whether such information is in text or otherwise.

[1/2005]

[Aust. Corporations 2001, s. 739]

Contents of prospectus

243.—(1) A prospectus for an offer of securities shall contain—

- (a) all the information that investors and their professional advisers would reasonably require to make an informed assessment of the matters specified in subsection (3); and
- (b) the matters prescribed by the Authority.

[1/2005]

(2) The prospectus shall, with respect to subsection (1) (a), contain such information—

- (a) only to the extent to which it is reasonable for investors and their professional advisers to expect to find in the prospectus; and
- (b) only to the extent that a person whose knowledge is relevant—

- (i) actually knows the information; or
- (ii) in the circumstances ought reasonably to have obtained the information by making enquiries.

(3) The matters referred to in subsection (1) (a) shall relate to—

- (a) the rights and liabilities attaching to the securities;
- (b) the assets and liabilities, profits and losses, financial position and performance, and prospects of the issuer;
- (c) if the underlying entity is controlled by—

- (i) the person making the offer;
- (ii) one or more of the related parties of the person making the offer; or
- (iii) the person making the offer and one or more of his related parties,

the assets and liabilities, profits and losses, financial position and performance, and prospects of that entity; and

(d) in the case of an offer of units of shares or debentures, where the person making the offer, or an entity which is controlled by—

- (i) the person making the offer;
- (ii) one or more of the related parties of the person making the offer; or
- (iii) the person making the offer and one or more of his related parties,

is or will be required to issue or deliver the relevant securities, or to meet financial or contractual obligations to the holders of those units, the capacity of that person or entity to issue or deliver the relevant securities, or the ability of that person or entity to meet those financial or contractual obligations.

[1/2005]

(4) In deciding what information shall be included under subsection (1) (a), regard shall be had to—

- (a) the nature of the securities and the nature of the entity concerned;
- (b) the matters that likely investors may reasonably be expected to know; and
- (c) the fact that certain matters may reasonably be expected to be known to the professional advisers of such investors.

[1/2005]

(5) For the purposes of subsection (2) (b), a person's knowledge is relevant only if he is one of the following persons:

- (a) the person making the offer;
- (b) if the person making the offer is an entity, a director or an equivalent person of the entity;
- (c) the issuer;
- (d) a director or an equivalent person, or a proposed director or an equivalent person, of the issuer;
- (da) a person named in the prospectus with his consent as an underwriter to the issue or sale;
- (e) a person named in the prospectus as a stockbroker to the issue or sale if he participates in any way in the preparation of the prospectus;
- (f) a person named in the prospectus with his consent as having made a statement—
- (i) that is included in the prospectus; or
- (ii) on which a statement made in the prospectus is based;
- (g) a person named in the prospectus with his consent as having performed a particular professional or advisory function.

[1/2005]

(6) A condition requiring or binding an applicant for securities to waive compliance with any requirement of this section, or purporting to affect him with notice of any contract, document or matter not specifically referred to in the prospectus, shall be void.

[1/2005]

(7) This section does not affect any liability that a person has under any other law.

[Companies, s. 45; Aust. Corporations 2001, s. 710]

244. (Repealed by Act 16/2003)

Retention of over-subscriptions and statement of asset-backing in debenture issues

245.—(1) An entity shall not accept or retain subscriptions to a debenture issue in excess of the amount of the issue as disclosed in the prospectus unless the entity has specified in the prospectus—

- (a) that it expressly reserves the right to accept or retain over-subscriptions; and

continued on next page

Box A1.1 continuation

(b) a limit expressed as a specific sum of money on the amount of over-subscriptions that may be accepted or retained, being an amount not more than 25% in excess of the amount of the issue as disclosed in the prospectus.

[1/2005]

(2) Subject to regulations made by the Authority for the purposes of this subsection, where an entity specifies in a prospectus relating to a debenture issue that it reserves the right to accept or retain over-subscriptions—

(a) the entity shall not make, authorise or permit any statement of or reference as to the asset-backing for the issue to be made or contained in any prospectus relating to the issue, other than a statement or reference to the total tangible assets and the total liabilities of the entity and of its guarantor entities; and

(b) the prospectus shall contain a statement or reference as to what the total assets and total liabilities of the entity would be if over-subscriptions to the limit specified in the prospectus were accepted or retained.

[1/2005]

(3) Every entity or other person that contravenes subsection (1) or (2) shall be guilty of an offence and shall be liable on conviction to a fine not exceeding \$50,000 and, in the case of a continuing offence, to a further fine not exceeding \$5,000 for every day or part thereof during which the offence continues after conviction.

[1/2005]

[Companies, s. 49]

Contents of profile statement

246.—(1) A profile statement for an offer of securities shall contain—

(a) the following particulars:

(i) identification of the person making the offer and, where the person making the offer is not the issuer, the issuer and, where applicable, the underlying entity;

(ii) identification of the persons signing the profile statement;

(iii) the nature of the securities;

(iv) the nature of the risks involved in investing in the securities;

(v) details of all amounts payable in respect of the securities (including any amount by way of fee, commission or charge);

(b) a statement that copies of the prospectus are available for collection at the times and places specified in the profile statement; and

(c) a statement that the persons referred to in section 240 (4A) who have signed the profile statement are satisfied that the profile statement contains a fair summary of the key information in the prospectus.

[1/2005]

(2) A profile statement shall not contain—

(a) any statement that is false or misleading in the form and context in which it is included;

(b) any material information that is not contained in the prospectus; and

(c) any material information that differs in any material particular from that set out in the prospectus.

[1/2005]

(3) For the purposes of subsection (2) (a), the reference to a statement shall include a reference to any information presented, regardless of whether such information is in text or otherwise.

[1/2005]

[Companies, s. 45A; Aust. Corporations 2001, s. 714]

Exemption from requirements as to form or content of prospectus or profile statement

247.—(1) The Authority may exempt any person or any prospectus or profile statement from any requirement of this Act relating to the form or content of a prospectus or profile statement, subject to such conditions or restrictions as may be determined by the Authority.

[16/2003]

(2) The Authority shall not grant an exemption under subsection (1) unless it is of the opinion that—

(a) the cost of complying with the requirement in respect of which exemption has been applied for outweighs the resulting protection to investors; or

(b) it would not be prejudicial to the public interest if the requirement in respect of which exemption has been applied for were dispensed with.

[16/2003]

(3) The Authority may exempt any class of persons, or any class or description of prospectuses or profile statements, from any requirement of this Act relating to the form or content of a prospectus or profile statement, subject to such conditions or restrictions as may be determined by the Authority.

[16/2003]

(4) *(Deleted by Act 16/2003)*

(5) Any person who contravenes any of the conditions or restrictions imposed under subsection (1) or (3) shall be guilty of an offence and shall be liable on conviction to a fine not exceeding \$50,000 and, in the case of a continuing offence, to a further fine not exceeding \$5,000 for every day or part thereof during which the offence continues after conviction.

[Companies, s. 46]

Exemption for certain governmental and international entities as regards signing of copy of prospectus or profile statement by all directors or equivalent persons

248.—(1) This section shall apply only to entities that are both of a governmental and international character.

[1/2005]

(2) An entity to which this section applies may apply in writing to the Authority for an exemption from the requirements of section 240 (1) (a) (ii), (4) (b),

continued on next page

Box A1.1 continuation

(4A), (13) (c) and (14) (c) and the Authority may, if it considers those requirements unduly burdensome on the entity, exempt such entity from complying therewith.

[1/2005]

(3) The Authority may subject such exemption to a requirement that such minimum number of directors or equivalent persons who are resident in Singapore as the Authority may, in that case, decide must sign the copy of the prospectus or profile statement.

[1/2005]

(4) In the event that no director or equivalent person is resident in Singapore, the Authority may permit a duly authorised agent to sign the prospectus or profile statement so long as such authorisation is supported by a resolution of the board of the entity.

[1/2005]

(5) The Authority may, if satisfied that a particular entity cannot comply with any of the requirements in subsection (3) or (4), grant the exemption applied for.

[1/2005]

(6) Any prospectus or profile statement that complies with the terms of exemption granted by the Authority shall be deemed to be a prospectus or profile statement for the purposes of this Division and a copy of such prospectus or profile statement shall be registered by the Authority.

[Companies, s. 51]

Expert's consent to issue of prospectus or profile statement containing statement by him

249.—(1) Where an offer of securities is made in or accompanied by a prospectus or profile statement which includes a statement purporting to be made by, or based on a statement made by, an expert, the prospectus or profile statement shall not be issued unless—

(a) the expert has given, and has not before the registration of the prospectus or profile statement, as the case may be, withdrawn his written consent to the issue thereof with the statement included in the form and context in which it is included; and

(b) there appears in the prospectus or profile statement, as the case may be, a statement that the expert has given and has not withdrawn his consent.

[1/2005]

(1A) Every person making the offer shall cause a true copy of every written consent referred to in subsection (1) to be deposited, within 7 days after the registration of the prospectus or profile statement, at the registered office of the issuer in Singapore or, if the issuer has no registered office in Singapore, at the address in Singapore specified in the prospectus for that purpose.

[1/2005]

(1B) Every issuer shall keep, and make available for inspection by its members and creditors and persons who have subscribed for or purchased the securities to which the prospectus or profile statement relates, without payment of any fee, a true copy of every written consent deposited in accordance with subsection (1A) for a period of at least 6 months after the registration of the prospectus or profile statement.

[1/2005]

(2) If any prospectus or profile statement is issued in contravention of subsection (1), the person making the offer and every person who is knowingly a party to the issue thereof shall be guilty of an offence and shall be liable on conviction to a fine not exceeding \$50,000 or to imprisonment for a term not exceeding 12 months or to both and, in the case of a continuing offence, to a further fine not exceeding \$5,000 for every day or part thereof during which the offence continues after conviction.

[16/2003;1/2005]

(3) The Authority may exempt any person or class of persons, or any prospectus or profile statement or class or description of prospectuses or profile statements, from this section, subject to such conditions or restrictions as may be determined by the Authority.

[16/2003;1/2005]

(4) Any person who contravenes any of the conditions or restrictions imposed under subsection (3) shall be guilty of an offence and shall be liable on conviction to a fine not exceeding \$50,000 and, in the case of a continuing offence, to a further fine not exceeding \$5,000 for every day or part thereof during which the offence continues after conviction.

[16/2003]

[Companies, s. 54]

Consent of issue manager and underwriter to being named in prospectus or profile statement

249A.—(1) Where an offer of securities is made in or accompanied by a prospectus or profile statement in which a person is named as the issue manager to the offer, the prospectus or profile statement shall not be issued unless—

(a) the person has given, and has not before the registration of the prospectus or profile statement, as the case may be, withdrawn his written consent to being named in the prospectus or profile statement as issue manager to that offer; and

(b) there appears in the prospectus or profile statement, as the case may be, a statement that the person has given and has not withdrawn his consent.

[1/2005]

(2) Where an offer of securities is made in or accompanied by a prospectus or profile statement in which a person is named as the underwriter (but not a sub-underwriter) to the offer, the prospectus or profile statement shall not be issued unless—

(a) the person has given, and has not before the registration of the prospectus or profile statement, as the case may be, withdrawn his written consent to being named in the prospectus or profile statement as underwriter to that offer; and

(b) there appears in the prospectus or profile statement, as the case may be, a statement that the person has given and has not withdrawn such consent.

[1/2005]

(3) If any prospectus or profile statement is issued in contravention of subsection (1) or (2), the person making the offer and every person who is

continued on next page

Box A1.1 continuation

knowingly a party to the issue thereof shall be guilty of an offence and shall be liable on conviction to a fine not exceeding \$50,000 or to imprisonment for a term not exceeding 12 months or to both and, in the case of a continuing offence, to a further fine not exceeding \$5,000 for every day or part thereof during which the offence continues after conviction.

[1/2005]

(4) Every person making the offer shall cause a true copy of every written consent referred to in subsections (1) and (2) to be deposited, within 7 days after the registration of the prospectus or profile statement, at the registered office of the issuer in Singapore or, if it has no registered office in Singapore, at the address in Singapore specified in the prospectus for that purpose.

[1/2005]

(5) Every issuer shall keep, and make available for inspection by its members and creditors and persons who have subscribed for or purchased the securities to which the prospectus or profile statement relates, without payment of any fee, a true copy of every written consent deposited in accordance with subsection (4) for a period of at least 6 months after the registration of the prospectus or profile statement.

[1/2005]

Duration of validity of prospectus and profile statement

250.—(1) No person shall make an offer of securities, or allot, issue or sell any securities, on the basis of a prospectus or profile statement after the expiration of the period referred to in subsection (3).

[1/2005]

(2) In a case where an entity makes an offer of securities or where the securities being offered are those issued by an entity or a proposed entity, no officer or equivalent person or promoter of the entity or proposed entity shall authorise or permit—

- (a) the offer of those securities; or
- (b) the allotment, issue or sale of those securities,

on the basis of a prospectus or profile statement after the expiration of the period referred to in subsection (3).

[1/2005]

(3) The period under subsection (1) or (2) is—

- (a) in a case where the securities are debentures or units of debentures issued under a debenture issuance programme under section 240A, 24 months from the date of registration by the Authority of the base prospectus in relation to such offer, allotment, issue or sale; or
- (b) in any other case, 6 months from the date of registration by the Authority of the prospectus in relation to such offer, allotment, issue or sale.

[1/2005]

(4) If default is made in complying with subsection (1) or (2), the person and, in the case of an entity or a proposed entity, every officer or equivalent person or promoter of the entity or proposed entity shall be guilty of an offence and shall be liable on conviction to a fine not exceeding \$50,000 or to imprisonment for a term not exceeding 12 months or to both and, in the case of a continuing offence, to a further fine not exceeding \$5,000 for every day or part thereof during which the offence continues after conviction.

[1/2005]

(5) An allotment, an issue or a sale of securities that is made in contravention of subsection (1) or (2) shall not, by reason only of that fact, be voidable or void.

[1/2005]

[Companies, s. 57 (8)-(10)]

Restrictions on advertisements, etc.

251.—(1) If a prospectus is required for an offer or intended offer of securities, a person shall not—

- (a) advertise the offer or intended offer; or
- (b) publish a statement that—
 - (i) directly or indirectly refers to the offer or intended offer; or
 - (ii) is reasonably likely to induce persons to subscribe for or purchase the securities, unless the advertisement or publication is authorised by this section.

[1/2005]

(2) In determining whether a statement—

- (a) indirectly refers to an offer or intended offer of securities; or
- (b) is reasonably likely to induce persons to subscribe for or purchase securities, regard shall be had to whether the statement—
 - (i) forms part of the normal advertising of an entity's products or services and is genuinely directed at maintaining its existing customers, or attracting new customers, for those products or services;
 - (ii) communicates information that materially deals with the affairs of the entity; and
 - (iii) is likely to encourage investment decisions being made on the basis of the statement rather than on the basis of information contained in a prospectus or profile statement.

[1/2005]

(3) Notwithstanding subsection (6), a person may, before a prospectus or profile statement is registered by the Authority, disseminate a preliminary document which has been lodged with the Authority to institutional investors, relevant persons as defined in section 275 (2) or persons to whom an offer referred to in section 275 (1A) is to be made without contravening subsection (1), if—

(a) the front page of the preliminary document contains—

(i) the following statement:

"This is a preliminary document and is subject to further amendments and completion in the prospectus to be registered by the Monetary Authority of

continued on next page

Box A1.1 continuation

Singapore.”;

- (ii) a statement that a person to whom a copy of the preliminary document has been issued shall not circulate it to any other person; and
- (iii) a statement in bold lettering that no offer or agreement shall be made on the basis of the preliminary document to purchase or subscribe for any securities to which the preliminary document relates;
- (b) the preliminary document does not contain or have attached to it any form of application that will facilitate the making by any person of an offer of the securities to which the preliminary document relates, or the acceptance of such an offer by any person; and
- (c) when the prospectus is registered by the Authority, the person takes reasonable steps to notify the persons to whom the preliminary document was issued that the registered prospectus is available for collection.

[1/2005]

(4) Notwithstanding subsection (6), a person does not contravene subsection (1) by presenting oral or written material, on matters contained in a preliminary document which has been lodged with the Authority, to institutional investors, relevant persons as defined in section 275 (2) or persons to whom an offer referred to in section 275 (1A) is to be made before a prospectus or profile statement is registered by the Authority.

[1/2005]

(5) For the avoidance of doubt, a person may disseminate a prospectus or profile statement that has been registered by the Authority under section 240 without contravening subsection (1).

[1/2005]

(6) Before a prospectus or profile statement is registered, an advertisement or publication does not contravene subsection (1) if it contains only the following:

- (a) a statement that identifies the securities, the person making the offer, the issuer and, where applicable, the underlying entity;
- (b) a statement that a prospectus or profile statement for the offer will be made available when the offer is made;
- (c) a statement that anyone wishing to acquire the securities will need to make an application in the manner set out in the prospectus or profile statement; and
- (d) a statement of how to obtain, or arrange to receive, a copy of the prospectus or profile statement.

[1/2005]

(7) To satisfy subsection (6), the advertisement or publication shall include all of the statements referred to in paragraphs (a), (b) and (c) of that subsection, and may include the statement referred to in paragraph (d).

(8) After a prospectus or profile statement is registered with the Authority, an advertisement or a publication does not contravene subsection (1) if—

- (a) it includes a statement that the prospectus or profile statement in respect of the offer of securities is available for collection at the times and places specified in the statement;
- (b) it includes a statement that anyone wishing to acquire the securities will need to make an application in the manner set out in the prospectus or profile statement; and
- (c) it does not contain any information that is not included in the prospectus or profile statement.

[1/2005]

(9) An advertisement or a publication does not contravene subsection (1) if it—

- (a) consists solely of a disclosure, notice or report required under this Act, or any listing rules or other requirements of a securities exchange, futures exchange or overseas securities exchange made by any person;
- (b) consists solely of a notice or report of a general meeting or proposed general meeting of the person making the offer, the issuer, the underlying entity or any entity, or a presentation of oral or written material on matters so contained in the notice or report at the general meeting;
- (c) consists solely of a report about the issuer or the underlying entity that is published by the person making the offer, the issuer or the underlying entity, which—
 - (i) does not contain information that materially affects the affairs of the issuer or underlying entity other than information previously made available in a prospectus that has been registered by the Authority, an annual report or a disclosure, notice or report referred to in paragraph (a) or (b); and
 - (ii) does not refer (directly or indirectly) to the offer or intended offer;
- (d) consists solely of a statement made by the person making the offer, the issuer or the underlying entity that a prospectus or profile statement in respect of the offer or intended offer has been lodged with the Authority;
- (e) is a news report, or a genuine comment, by a person other than any person referred to in paragraph (f) (i), (ii), (iii) or (iv), in a newspaper, periodical or magazine or on radio, television or any other means of broadcasting or communication, relating to—
 - (i) a prospectus or profile statement that has been lodged with the Authority or information contained in such a prospectus or profile statement;
 - (ii) a disclosure, notice or report referred to in paragraph (a);
 - (iii) a notice, report, presentation, general meeting or proposed general meeting referred to in paragraph (b);
 - (iv) a report referred to in paragraph (c);
- (f) is a report about the securities which are the subject of the offer or intended offer, published by someone who is not—
 - (i) the person making the offer, the issuer or the underlying entity;
 - (ii) a director or an equivalent person of the person making the offer, the issuer or the underlying entity;
 - (iii) a person who has an interest in the success of the issue or sale of the securities; or
 - (iv) a person acting at the instigation of, or by arrangement with, any person referred to in sub-paragraph (i), (ii) or (iii);
- (g) is a report about the securities which are the subject of the offer or intended offer, published and delivered to any institutional investor not later than 14 days prior to the date of lodgment of the prospectus, provided that—
 - (i) the offer is also made or will also be made in one or more other countries;
 - (ii) the publication and delivery of such report in that other country or any one of those other countries do not infringe any law, code or other requirement of that country;

continued on next page

Box A1.1 continuation

(iii) the report and the manner of its publication and delivery in Singapore comply with such other requirements as may be prescribed by the Authority; and
 (iv) the person issuing the report complies with such requirements as may be prescribed by the Authority; or
 (h) is a publication made by the person making the offer, the issuer or the underlying entity solely to correct or provide clarification on any erroneous or inaccurate information or comment contained in—
 (i) an earlier news report or a genuine comment referred to in paragraph (e); or
 (ii) an earlier publication published in the ordinary course of business of publishing a newspaper, periodical or magazine, or of broadcasting by radio, television or any other means of broadcasting or communication, referred to in subsection (10),
 provided that the first-mentioned publication does not contain any material information that is not included in the prospectus.

[1/2005]

(10) A person does not contravene subsection (1) if—

(a) he publishes any advertisement or publication in the ordinary course of a business of—

(i) publishing a newspaper, periodical or magazine; or

(ii) broadcasting by radio, television, or any other means of broadcasting or communication; and

(b) he did not know and had no reason to suspect that its publication would constitute a contravention of subsection (1).

(11) Subsection (9) (e) and (f) shall not apply to an advertisement or statement if any person gives consideration or any other benefit for the publication of the advertisement or statement.

[1/2005]

(12) Any person who contravenes subsection (1) or who knowingly authorised or permitted the publication or dissemination in contravention of subsection (1) shall be guilty of an offence and shall be liable on conviction to a fine not exceeding \$50,000 or to imprisonment for a term not exceeding 12 months or to both and, in the case of a continuing offence, to a further fine not exceeding \$5,000 for every day or part thereof during which the offence continues after conviction.

[1/2005]

(13) This section does not affect any liability that a person has under any other law.

(14) The Authority may exempt any person or class of persons from this section, subject to such conditions or restrictions as may be determined by the Authority.

(15) Any person who contravenes any of the conditions or restrictions imposed under subsection (14) shall be guilty of an offence and shall be liable on conviction to a fine not exceeding \$50,000 and, in the case of a continuing offence, to a further fine not exceeding \$5,000 for every day or part thereof during which the offence continues after conviction.

(16) For the purposes of this section, any reference to publishing a statement shall be construed as including a reference to making a statement, whether oral or written, which is reasonably likely to be published.

[1/2005]

(17) For the purposes of subsections (1) and (2), any reference to a statement shall include a reference to any information presented, regardless of whether such information is in text or otherwise.

[1/2005]

(18) For the purposes of subsection (2) (ii), the reference to affairs of the entity shall—

(a) in the case where the entity is a corporation, be construed as including a reference to the matters referred to in section 2 (2); and

(b) in any other case, be construed as a reference to such matters as may be prescribed by the Authority.

[1/2005]

(19) For the purposes of subsection (9) (c) (i), the reference to affairs of the issuer or underlying entity shall—

(a) in the case where the issuer or underlying entity is a corporation, be construed as including a reference to the matters referred to in section 2 (2); and

(b) in any other case, be construed as a reference to such matters as may be prescribed by the Authority.

[1/2005]

[Companies, s. 48; Aust. Corporations 2001, s. 734]

Persons liable on prospectus or profile statement to inform person making offer about certain deficiencies

252.—(1) A person referred to in section 254 (3) (other than paragraph (a)) shall notify in writing the person making the offer of securities, as soon as practicable, if he becomes aware at any time after the prospectus or profile statement is registered by the Authority but before the close of the offer that—

(a) a statement in the prospectus or the profile statement is false or misleading;

(b) there is an omission to state any information required to be included in the prospectus under section 243 or there is an omission to state any information required to be included in the profile statement under section 246, as the case may be; or

(c) a new circumstance—

(i) has arisen since the prospectus or the profile statement was lodged with the Authority; and

(ii) would have been required to be included in the prospectus under section 243, or required to be included in the profile statement under section 246, as the case may be, if it had arisen before the prospectus or the profile statement was lodged with the Authority, and the failure to so notify would have been materially adverse from the point of view of an investor.

[16/2003;1/2005]

(2) Any person who contravenes subsection (1) shall be guilty of an offence and shall be liable on conviction to a fine not exceeding \$50,000.

(3) For the purposes of subsection (1) (a), any reference to a statement shall include a reference to any information presented, regardless of whether

continued on next page

Box A1.1 continuation

such information is in text or otherwise.

[1/2005]

[Companies, s. 55A; Aust. Corporations 2001, s. 730]

Criminal liability for false or misleading statements

253.—(1) Where an offer of securities is made in or accompanied by a prospectus or profile statement, or, in the case of an offer referred to in section 280, where a prospectus or profile statement is prepared and issued in relation to the offer, and—

(a) a false or misleading statement is contained in—

- (i) the prospectus or the profile statement; or
- (ii) any application form for the securities;

(b) there is an omission to state any information required to be included in the prospectus under section 243 or there is an omission to state any information required to be included in the profile statement under section 246, as the case may be; or

(c) there is an omission to state a new circumstance that—

- (i) has arisen since the prospectus or the profile statement was lodged with the Authority; and
 - (ii) would have been required to be included in the prospectus under section 243, or required to be included in the profile statement under section 246, as the case may be, if it had arisen before the prospectus or the profile statement was lodged with the Authority,
- the persons referred to in subsection (4) shall be guilty of an offence even if such persons, unless otherwise specified, were not involved in the making of the false or misleading statement or the omission, and shall be liable on conviction to a fine not exceeding \$150,000 or to imprisonment for a term not exceeding 2 years or to both and, in the case of a continuing offence, to a further fine not exceeding \$15,000 for every day or part thereof during which the offence continues after conviction.

[16/2003;1/2005]

(2) For the purposes of subsection (1), a false or misleading statement about a future matter (including the doing of, or the refusal to do, an act) is taken to have been made if a person made the statement without having reasonable grounds for making the statement.

(3) A person shall not be taken to have contravened subsection (1) if the false or misleading statement, or the omission to state any information or new circumstance, is not materially adverse from the point of view of the investor.

(4) The persons guilty of the offence are—

- (a) the person making the offer;
- (b) where the person making the offer is an entity—
 - (i) each director or equivalent person of the entity; and
 - (ii) if the entity is also the issuer, each person who is, and who has consented to be, named in the prospectus or profile statement as a proposed director or an equivalent person of the entity;
- (c) where the issuer is controlled by the person making the offer, one or more of the related parties of the person making the offer, or the person making the offer and one or more of his related parties—
 - (i) the issuer;
 - (ii) each director or equivalent person of the issuer; and
 - (iii) each person who is, and who has consented to be, named in the prospectus or profile statement as a proposed director or an equivalent person of the issuer;
- (d) an issue manager to the offer of the securities who is, and who has consented to be, named in the prospectus or profile statement, if—
 - (i) he intentionally or recklessly makes the false or misleading statement or omits to state the information or circumstance;
 - (ii) knowing that the statement in the prospectus or profile statement is false or misleading or that the information or circumstance has been omitted, he fails to take such remedial action as is appropriate in the circumstances without delay; or
 - (iii) he is reckless as to whether the statement is false or misleading or whether the information or circumstance has been included;
- (e) an underwriter (but not a sub-underwriter) to the issue or sale of the securities who is, and who has consented to be, named in the prospectus or profile statement, if—
 - (i) he intentionally or recklessly makes the false or misleading statement or omits to state the information or circumstance;
 - (ii) knowing that the statement is false or misleading or that the information or circumstance has been omitted, he fails to take such remedial action as is appropriate in the circumstances without delay; or
 - (iii) he is reckless as to whether the statement is false or misleading or whether the information or circumstance has been included;
- (f) a person named in the prospectus or the profile statement with his consent as having made—
 - (i) the statement that is false or misleading, if he intentionally or recklessly makes that statement; or
 - (ii) a statement on which the false or misleading statement is based, if he knows that the second-mentioned statement is false or misleading and fails to take immediate steps to withdraw his consent, but only in respect of the inclusion of the false or misleading statement; and
- (g) any other person who intentionally or recklessly makes the false or misleading statement, or omits to state the information or circumstance, as the case may be, but only in respect of the inclusion of the statement or the omission to state the information or circumstance, as the case may be.

[1/2005]

(5) For the purposes of subsection (4) and this subsection—

(a) remedial action includes any of the following:

- (i) preventing the statement from being included, or having the information or circumstance included, in the prospectus or profile statement, as the case may be;
- (ii) procuring the lodgment of a supplementary or replacement prospectus under section 241; and

continued on next page

Box A1.1 continuation

(b) a person is reckless as to the matter referred to in subsection (4) (d) (iii) or (e) (iii) if, having been put upon inquiry that the statement to be, or which has been, included in the prospectus or profile statement is likely to be false or misleading, that the information or circumstance is likely to be required to be included in that document, or that there is likely to be an omission to state the information or circumstance in that document, he fails to—

- (i) make all inquiries as are reasonable in the circumstances to verify this; and
- (ii) take such remedial action as is appropriate in the circumstances without delay, if such action is warranted by the outcome of the inquiries.

[1/2005]

(6) For the purposes of this section, any reference to a statement shall include a reference to any information presented, regardless of whether such information is in text or otherwise.

[1/2005]

[Companies, s. 56; Aust. Corporations 2001, s. 728]

Civil liability for false or misleading statements

254.—(1) Where an offer of securities is made in or accompanied by a prospectus or profile statement, or, in the case of an offer referred to in section 280, where a prospectus or profile statement is prepared and issued in relation to the offer, and—

(a) a false or misleading statement is contained in—

- (i) the prospectus or the profile statement; or
- (ii) any application form for the securities;

(b) there is an omission to state any information required to be included in the prospectus under section 243 or there is an omission to state any information required to be included in the profile statement under section 246, as the case may be; or

(c) there is an omission to state a new circumstance that—

- (i) has arisen since the prospectus or the profile statement was lodged with the Authority; and
 - (ii) would have been required by section 243 to be included in the prospectus, or required to be included in the profile statement under section 246, as the case may be, if it had arisen before the prospectus or the profile statement was lodged with the Authority,
- the persons referred to in subsection (3) shall be liable to compensate any person who suffers loss or damage as a result of the false or misleading statement in or omission from the prospectus or the profile statement, even if such persons, unless otherwise specified, were not involved in the making of the false or misleading statement or the omission.

[16/2003;1/2005]

(2) For the purposes of subsection (1), a false or misleading statement about a future matter (including the doing of, or the refusal to do, an act) is taken to have been made if a person makes the statement without having reasonable grounds for making the statement.

(3) The persons liable are—

- (a) the person making the offer;
- (b) where the person making the offer is an entity—
 - (i) each director or equivalent person of the entity; and
 - (ii) if the entity is also the issuer, each person who is, and who has consented to be, named in the prospectus or profile statement as a proposed director or an equivalent person of the entity;
- (c) where the issuer is controlled by the person making the offer, one or more of the related parties of the person making the offer, or the person making the offer and one or more of his related parties—
 - (i) the issuer;
 - (ii) each director or equivalent person of the issuer; and
 - (iii) each person who is, and who has consented to be, named in the prospectus or the profile statement as a proposed director or an equivalent person of the issuer;
- (d) an issue manager to the offer of the securities who is, and who has consented to be, named in the prospectus or the profile statement;
- (da) an underwriter (but not a sub-underwriter) to the issue or sale of the securities who is, and who has consented to be, named in the prospectus or the profile statement;
- (e) a person named in the prospectus or the profile statement with his consent as having made a statement—
 - (i) that is included in the prospectus or the profile statement; or
 - (ii) on which a statement made in the prospectus or the profile statement is based, but only in respect of the inclusion of that statement; and
- (f) any other person who made the false or misleading statement or omitted to state the information or circumstance, as the case may be, but only in respect of the inclusion of the statement or the omission to state the information or circumstance.

[1/2005]

(4) A person who acquires securities as a result of an offer that was made in or accompanied by a profile statement is taken to have acquired the securities in reliance on both the profile statement and the prospectus for the offer.

[1/2005]

(4A) For the purposes of this section, any reference to a statement shall include a reference to any information presented, regardless of whether such information is in text or otherwise.

[1/2005]

(5) No action under subsection (1) shall be commenced after the expiration of 6 years from the date on which the cause of action arose.

(6) This section does not affect any liability that a person has under any other law.

[Companies, s. 55; Aust. Corporations 2001, s. 728]

continued on next page

*Box A1.1 continuation***Defences**

255.—(1) A person referred to in section 253 (4) (a), (b) or (c) is not liable under section 253 (1), and a person referred to in section 254 (3) is not liable under section 254 (1), only because of a false or misleading statement in a prospectus or a profile statement if the person proves that he—
 (a) made all inquiries (if any) that were reasonable in the circumstances; and
 (b) after doing so, believed on reasonable grounds that the statement was not false or misleading.

[1/2005]

(2) A person referred to in section 253 (4) (a), (b) or (c) is not liable under section 253 (1), and a person referred to in section 254 (3) is not liable under section 254 (1), only because of an omission from a prospectus or a profile statement in relation to a particular matter if the person proves that he—

- (a) made all inquiries (if any) that were reasonable in the circumstances; and
 (b) after doing so, believed on reasonable grounds that there was no omission from the prospectus or profile statement in relation to that matter.

[1/2005]

(3) A person is not liable under section 253 (1) or 254 (1) only because of a false or misleading statement in, or an omission from, a prospectus or a profile statement if the person proves that he placed reasonable reliance on information given to him by—

- (a) if the person is an entity, someone other than—
 (i) a director or an equivalent person; or
 (ii) an employee or agent, of the entity; or
 (b) if the person is an individual, someone other than an employee or agent of the individual.

[1/2005]

(4) For the purposes of subsection (3), a person is not the agent of an entity or individual merely because he performs a particular professional or advisory function for the entity or individual.

[1/2005]

(5) A person who is named in a prospectus or a profile statement as—

- (a) a proposed director or an equivalent person of the issuer, or an issue manager or underwriter;
 (b) having made a statement included in the prospectus or the profile statement; or
 (c) having made a statement on the basis of which a statement is included in the prospectus or the profile statement,
 is not liable under section 253 (1) or 254 (1) only because of a false or misleading statement in, or an omission from, the prospectus or the profile statement if the person proves that he publicly withdrew his consent to being named in the prospectus or the profile statement in that way.

[1/2005]

(6) A person is not liable under section 253 (1) or 254 (1) only because of a new circumstance that has arisen since the prospectus or the profile statement was lodged with the Authority if the person proves that he was not aware of the matter.

(7) For the purposes of this section, any reference to a statement shall include a reference to any information presented, regardless of whether such information is in text or otherwise.

[1/2005]

[Companies, s. 55B; Aust. Corporations 2001, s. 731, s. 732 and s. 733]

256. (Repealed by Act 1/2005)

Document containing offer of securities for sale deemed prospectus

257.—(1) Subsection (2) applies where—

- (a) an entity allots or agrees to allot to any person any securities of the entity with a view to all or any of them being subsequently offered for sale to another person; and
 (b) such offer (referred to in this section as a subsequent offer) does not qualify for an exemption under Subdivision (4) of this Division (other than section 280).

[1/2005]

(2) Any document by which the subsequent offer is made shall for all purposes be deemed to be a prospectus issued by the entity, and the entity shall for all purposes be deemed to be the person making the offer, and all written laws and rules of law as to the contents of prospectuses and to liability in respect of statements and non-disclosure in prospectuses, or otherwise relating to prospectuses, shall apply and have effect accordingly as if—

- (a) an offer of securities has been made; and
 (b) persons accepting the subsequent offer in respect of any securities were subscribers therefor, but without prejudice to the liability, if any, of the persons making the subsequent offer, in respect of statements or non-disclosures in the document or otherwise.

[16/2003;1/2005]

(3) For the purposes of this Act, it shall, unless the contrary is proved, be sufficient evidence that an allotment of, or an agreement to allot, securities was made with a view to the securities being subsequently offered for sale if it is shown—

- (a) that an offer of the securities or of any of them for sale was made within 6 months after the allotment or agreement to allot; or
 (b) that at the date when the offer was made the whole consideration to be received by the entity in respect of the securities had not been so received.

[1/2005]

(4) The requirements of this Division as to prospectuses shall have effect as though the persons making the subsequent offer were persons named in the prospectus as directors or equivalent persons of the entity.

continued on next page

Box A1.1 continuation

(5) In addition to complying with the other requirements of this Division, the document making the subsequent offer shall state—
 (a) the net amount of the consideration received or to be received by the entity in respect of the securities being offered; and
 (b) the place and time at which a copy of the contract under which the securities have been or are to be allotted may be inspected.

[1/2005]

[Companies, s. 52]

Application and moneys to be held in trust in separate bank account until allotment

258.—(1) All application and other moneys paid prior to allotment by any applicant on account of securities offered to him shall, until the allotment of the securities, be held by the person making the offer of the securities upon trust for the applicant in a separate bank account, being a bank account that is established and kept by the person solely for the purpose of depositing the application and other moneys that are paid by applicants for those securities.

[1/2005]

(2) There shall be no obligation or duty on any bank with which any such moneys have been deposited to enquire into or see to the proper application of those moneys, so long as the bank acts in good faith.

[1/2005]

(3) Any person who contravenes subsection (1) shall be guilty of an offence and shall be liable on conviction to a fine not exceeding \$50,000 or to imprisonment for a term not exceeding 2 years or to both and, in the case of a continuing offence, to a further fine not exceeding \$5,000 for every day or part thereof during which the offence continues after conviction.

[1/2005]

[Companies, s. 58]

Allotment of securities where prospectus indicates application to list on securities exchange

259.—(1) Where a prospectus states or implies that application has been or will be made for permission for the securities offered thereby to be listed for quotation on any securities exchange, and—

(a) the permission is not applied for in the form required by the securities exchange within 3 days from the date of the issue of the prospectus; or
 (b) the permission is not granted before the expiration of 6 weeks from the date of the issue of the prospectus or such longer period not exceeding 12 weeks from the date of the issue as is, within those 6 weeks, notified to the applicant by or on behalf of the securities exchange, then—

(i) any allotment whenever made of securities made on an application in pursuance of the prospectus shall, subject to subsection (3), be void; and
 (ii) any person who continues to allot such securities after the period specified in paragraph (a) or (b), shall be guilty of an offence and shall be liable on conviction to a fine not exceeding \$150,000 or to imprisonment for a term not exceeding 2 years or to both and, in the case of a continuing offence, to a further fine not exceeding \$15,000 for every day or part thereof during which the offence continues after conviction.

[1/2005]

(2) Where the permission has not been applied for, or has not been granted as mentioned under subsection (1), the person making the offer shall, subject to subsection (3), immediately repay without interest all moneys received from applicants in pursuance of the prospectus, and if any such moneys is not repaid within 14 days after the person making the offer so becomes liable to repay them, then—

(a) he shall be liable to repay those moneys with interest at the rate of 10% per annum from the expiration of such 14 days; and
 (b) where the person making the offer is an entity, in addition to the liability of the entity, the directors or equivalent persons of the entity shall be jointly and severally liable to repay those moneys with interest at the rate of 10% per annum from the expiration of such 14 days.

[1/2005]

(3) Where in relation to any securities of an entity—

(a) permission is not applied for as specified in subsection (1) (a); or
 (b) permission is not granted as specified in subsection (1) (b),

the Authority may, on the application of the entity made before any of the securities is purported to be allotted, exempt the allotment of the securities from the provisions of this section, and the Authority shall give notice of such exemption in the *Gazette*.

[1/2005]

(4) A director or an equivalent person shall not be liable under subsection (2) if he proves that the default in the repayment of the money was not due to any misconduct or negligence on his part.

[1/2005]

(5) Any condition requiring or binding any applicant for securities to waive compliance with any requirement of this section or purporting to do so shall be void.

[1/2005]

(6) Without limiting the application of any of its provisions, this section shall have effect—

(a) in relation to any securities agreed to be taken by a person underwriting an offer thereof contained in a prospectus as if he had applied therefor in pursuance of the prospectus; and
 (b) in relation to a prospectus offering securities for sale as if a reference to sale were substituted for a reference to allotment.

[1/2005]

(7) All moneys received from applicants in pursuance of the prospectus shall be kept in a separate bank account so long as the person making the offer may become liable to repay it under subsection (2).

[16/2003;1/2005]

continued on next page

Box A1.1 continuation

(8) Any person who contravenes subsection (7) shall be guilty of an offence and shall be liable on conviction to a fine not exceeding \$50,000 or to imprisonment for a term not exceeding 12 months or to both and, in the case of a continuing offence, to a further fine not exceeding \$5,000 for every day or part thereof during which the offence continues after conviction.

[1/2005]

(9) Where the securities exchange has within the time specified in subsection (1) (b) granted permission subject to compliance with any requirements specified by the securities exchange, permission shall be deemed to have been granted by the securities exchange if the directors or equivalent persons have given to the securities exchange an undertaking in writing to comply with the requirements of the securities exchange.

[1/2005]

(10) If any such undertaking referred to in subsection (9) is not complied with, each director or equivalent person who is in default shall be guilty of an offence and shall be liable on conviction to a fine not exceeding \$50,000 and, in the case of a continuing offence, to a further fine not exceeding \$5,000 for every day or part thereof during which the offence continues after conviction.

[1/2005]

(11) A person shall not issue a prospectus inviting persons to subscribe for securities of an entity if it includes—

- (a) a false or misleading statement that permission has been granted for those securities to be listed for quotation on, dealt in or quoted on any securities exchange; or
- (b) any statement in any way referring to any such permission or to any application or intended application for any such permission, or to listing for quotation, dealing in or quoting the securities, on any securities exchange, or to any requirement of a securities exchange, unless—
 - (i) that statement is or is to the effect that permission has been granted, or that application has been or will be made to the securities exchange within 3 days from the date of the issue of the prospectus; or
 - (ii) that statement has been approved by the Authority for inclusion in the prospectus.

[1/2005]

(12) Any person who contravenes subsection (11) shall be guilty of an offence and shall be liable on conviction to a fine not exceeding \$50,000 or to imprisonment for a term not exceeding 12 months or to both and, in the case of a continuing offence, to a further fine not exceeding \$5,000 for every day or part thereof during which the offence continues after conviction.

(13) Where a prospectus contains a statement to the effect that the memorandum and articles or other constituent document or documents of the issuer comply, or have been drawn so as to comply, with the requirements of any securities exchange, the prospectus shall, unless the contrary intention appears from the prospectus, be deemed for the purposes of this section to imply that application has been, or will be, made for permission for the securities to which the prospectus relates to be listed for quotation on the securities exchange.

[1/2005]

[Companies, s. 53]

Prohibition of allotment unless minimum subscription received

260.—(1) No allotment shall be made of any securities of a company unless—

- (a) the minimum subscription has been subscribed; and
- (b) the sum payable on application for the securities so subscribed has been received by the company, but if a cheque for the sum payable has been received by the company, the sum shall be deemed not to have been received by the company until the cheque is paid by the bank on which it is drawn.

[1/2005]

(2) The minimum subscription shall—

- (a) be calculated based on the price at which each share or debenture, or each unit of share or debenture, is or will be offered; and
- (b) be reckoned exclusively of any amount payable otherwise than in cash.

[1/2005]

(3) The amount payable on application on each share or debenture, or each unit of share or debenture, offered shall not be less than 5% of the price at which the share or debenture, or unit of share or debenture, is or will be offered.

[1/2005]

(4) If the conditions referred to in subsection (1) (a) and (b) have not been satisfied on the expiration of 4 months after the first issue of the prospectus, all moneys received from applicants for securities shall be immediately repaid to them without interest.

[1/2005]

(5) If any money referred to in subsection (4) is not repaid within 5 months after the issue of the prospectus, the directors of the company shall be jointly and severally liable to repay that money with interest at the rate of 10% per annum from the expiration of the period of 5 months; but a director shall not be so liable if he proves that the default in the repayment of the money was not due to any misconduct or negligence on his part.

(6) An allotment made by a company to an applicant in contravention of this section shall be voidable at the option of the applicant which option may be exercised by written notice served on the company—

- (a) within one month after the holding of the statutory meeting of the company and not later; or
- (b) in any case where the company is not required to hold a statutory meeting, or where the allotment is made after the holding of the statutory meeting, within one month after the date of the allotment and not later,

and the allotment shall be so voidable notwithstanding that the company is in the course of being wound up.

(7) Every director of a company who knowingly contravenes or permits or authorises the contravention of any of the provisions of this section shall be guilty of an offence and shall be liable in addition to the penalty or punishment for the offence to compensate the company and the allottee respectively for any loss, damages or costs which the company or the allottee has sustained or incurred thereby.

(8) No proceedings for the recovery of any compensation under subsection (7) shall be commenced after the expiration of 2 years from the date of the allotment.

continued on next page

Box A1.1 continuation

(9) Any condition requiring or binding any applicant for securities to waive compliance with any requirement of this section shall be void. [1/2005]

[Companies, s. 57]

Subdivision (3)—Debentures

Preliminary provisions

261.—(1) Subject to subsection (1A), this Subdivision shall apply where an entity makes an offer of debentures. [1/2005]

(1A) Sections 268, 269 and 270 shall not apply if the borrowing entity is a prescribed entity. [1/2005]

(1B) In subsections (1A) and (1C), “prescribed entity” means—

- (a) any bank licensed under the Banking Act (Cap. 19); or
- (b) any entity or entity of a class which has been declared by the Authority, by order published in the Gazette, to be a prescribed entity for the purposes of this section.

[1/2005]

(1C) The Authority may, by notice in writing—

- (a) impose such conditions or restrictions on a prescribed entity as it thinks fit; and
 - (b) at any time vary or revoke any condition or restriction so imposed,
- and the prescribed entity shall comply with every such condition or restriction imposed on it by the Authority that has not been revoked by the Authority.

[1/2005]

(1D) Any person who contravenes any condition or restriction imposed under subsection (1C) (a) shall be guilty of an offence and shall be liable on conviction to a fine not exceeding \$50,000 and, in the case of a continuing offence, to a further fine not exceeding \$5,000 for every day or part thereof during which the offence continues after conviction.

[1/2005]

(2) *(Deleted by Act 1/2005)*

(3) In this Subdivision, a corporation is related to another corporation if it is deemed to be related to that other corporation by virtue of section 6 of the Companies Act (Cap. 50).

Offer of asset-backed securities

262.—(1) An offer of asset-backed securities shall be made only if they are issued by—

- (a) a special purpose vehicle other than a trust; or
- (b) the trustee of a trust that is a special purpose vehicle.

[1/2005]

(2) The Authority may exempt any person or class of persons from this section, subject to such conditions or restrictions as may be determined by the Authority.

[1/2005]

(3) In this section—

“asset-backed securities” means debentures or units of debentures issued pursuant to a securitisation transaction;

“securitisation transaction” means an arrangement that involves the sale, transfer or assignment of assets to a special purpose vehicle where—

- (a) such sale, transfer or assignment is funded by the issue of debentures or units of debentures (whether by that special purpose vehicle or another special purpose vehicle); and

(b) payments in respect of such debentures or units of debentures are or will be principally derived, directly or indirectly, from the cash flows generated by the assets;

“special purpose vehicle” means an entity that is established solely in order to, or a trust that is established solely in order for its trustee to, do either or both of the following:

- (a) hold (whether as a legal or equitable owner) the assets from which payments to holders of any asset-backed securities are or will be primarily derived;
- (b) issue any asset-backed securities.

[1/2005]

263. *(Repealed by Act 16/2003)*

264. *(Repealed by Act 16/2003)*

Power of court in relation to certain irredeemable debentures

265.—(1) Notwithstanding anything in any debenture or trust deed, the security for any debentures which are irredeemable or redeemable only on the happening of a contingency shall, if the court so orders, be enforceable, immediately or at such other time as the court directs if, on the application of the trustee for the holders of the debentures or (where there is no trustee) on the application of any holder of the debentures, the court is satisfied that—

(a) at the time of the issue of the debentures the assets of the borrowing entity which constituted or were intended to constitute the security therefor were sufficient or likely to become sufficient to discharge the principal debt and any interest thereon;

(b) the security, if realised under the circumstances existing at the time of the application, would be likely to bring not more than 60% of the principal sum of moneys outstanding (regard being had to all prior charges and charges ranking *pari passu* if any); and

(c) the assets covered by the security, on a fair valuation on the basis of a going concern after allowing a reasonable amount for depreciation are worth less than the principal sum and the borrowing entity is not making sufficient profit to pay the interest due on the principal sum or (where no definite rate

continued on next page

Box A1.1 continuation

of interest is payable) interest thereon at such rate as the court considers would be a fair rate to expect from a similar investment.

[1/2005]

(2) Subsection (1) shall not affect any power to vary rights or accept any compromise or arrangement created by the terms of the debentures or the relevant trust deed or under a compromise or arrangement between the borrowing entity and creditors.

[1/2005]

[Companies, s. 100]

Duties of trustees

266.—(1) *(Deleted by Act 16/2003)*

(2) Where, after due inquiry, the trustee for the holders of debentures at any time is of the opinion that the assets of the borrowing entity and of any of its guarantor entities which are or should be available whether by way of security or otherwise, are insufficient, or likely to become insufficient, to discharge the principal debt as and when it becomes due, the trustee may apply to the Authority for an order under this subsection.

[1/2005]

(3) The Authority, on such application—

(a) after giving the borrowing entity an opportunity of making representations in relation to that application, by order in writing served on the entity at its registered office in Singapore, may impose such restrictions on the activities of the borrowing entity, including restrictions on advertising for deposits or loans and on borrowing by the entity as the Authority thinks necessary for the protection of the interests of the holders of the debentures; or
(b) may, and if the borrowing entity so requires, shall direct the trustee to apply to the court for an order under subsection (5); and the trustee shall apply accordingly.

[1/2005]

(4) Where—

(a) after due inquiry, the trustee at any time is of the opinion that the assets of the borrowing entity and of any of its guarantor entities which are or should be available, whether by way of security or otherwise, are insufficient or likely to become insufficient, to discharge the principal debt as and when it becomes due; or

(b) the borrowing entity has contravened an order made by the Authority under subsection (2),
the trustee may, and where the borrowing entity has requested the trustee to do so, shall apply to the court for an order under subsection (5).

[1/2005]

(5) Where an application is made to the court under subsection (3) or (4), the court may, after giving the borrowing entity an opportunity to be heard, by order, do all or any of the following things:

- (a) direct the trustee to convene a meeting of the holders of the debentures for the purpose of placing before them such information relating to their interests and such proposals for the protection of their interests as the trustee considers necessary or appropriate, and of obtaining their directions in relation thereto and give such directions in relation to the conduct of the meeting as the court thinks fit;
- (b) stay all or any actions or proceedings before any court by or against the borrowing entity;
- (c) restrain the payment of any moneys by the borrowing entity to the holders of debentures of the borrowing entity or to any class of such holders;
- (d) appoint a receiver of such of the property as constitutes the security, if any, for the debentures;
- (e) give such further directions from time to time as may be necessary to protect the interests of the holders of the debentures, the members of the borrowing entity or any of its guarantor entities or the public,
but in making any such order the court shall have regard to the rights of all creditors of the borrowing entity.

[1/2005]

(6) The court may vary or rescind any order made under subsection (5) as the court thinks fit.

(7) A trustee in making any application to the Authority or to the court shall have regard to the nature and kind of the security given when the offer of the debentures was made, and if no security was given shall have regard to the position of the holders of the debentures as unsecured creditors of the borrowing entity.

[1/2005]

(8) A trustee may rely upon any certificate or report given or statement made by any advocate and solicitor, auditor or officer of the borrowing entity or guarantor entity if it has reasonable grounds for believing that such advocate and solicitor, auditor or officer was competent to give or make the certificate, report or statement.

[1/2005]

[Companies, s. 101]

Powers of trustee to apply to court for directions, etc.

267.—(1) A trustee for the holders of debentures may apply to the court—

- (a) for directions in relation to any matter arising in connection with the performance of the functions of the trustee; or
- (b) to determine any question in relation to the interests of the holders of debentures.

(2) The court may—

- (a) give such directions to the trustee as the court thinks fit; and
 - (b) if satisfied that the determination of the question will be just and beneficial, accede wholly or partially to any such application on such terms and conditions as the court thinks fit or make such other order on the application as the court thinks just.
- (3) The court may, on an application under this section, order a meeting of all or any of the holders of debentures to be called to consider any matters in which they are concerned and to advise the trustee on those matters and may give such ancillary or consequential directions as the court thinks fit.
- (4) The meeting shall be held and conducted in such manner as the court directs, under the chairmanship of a person nominated by the trustee or such

continued on next page

Box A1.1 continuation

other person as the meeting appoints.

[Companies, s. 102]

Right of Authority, securities exchange and holders of debentures to apply to court for order

267A. Without prejudice to any other right of action or remedy in any written law or rule of law, a holder of debentures, the Authority or a securities exchange (in a case where the debentures are quoted or listed for quotation on that securities exchange) may apply to the court for an order to compel the trustee for the holders of such debentures to perform his duties as set out in the trust deed relating to those debentures, and the court may either make the order on such terms as it considers appropriate, or dismiss the application.

[16/2003]

Obligations of borrowing entity

268.—(1) Where there is a trustee for the holders of any debentures of a borrowing entity, the directors or equivalent persons of the borrowing entity shall—

(a) at the end of a period not exceeding 3 months ending on a day (being a day after the date of the issue of the relevant prospectus) which the trustee is hereby required to notify the borrowing entity in writing; and

(b) at the end of each succeeding period thereafter, being a period of 3 months or such shorter time as the trustee may, in any special circumstances allow,

prepare a report that relates to that period and complies with the requirements of subsection (2) and within one month after the end of each such period lodge a copy of the report relating to that period with the Authority and with the trustee.

[1/2005]

(2) The report referred to in subsection (1) shall be signed by not less than 2 of the directors or equivalent persons on behalf of all of them and shall set out in detail any matters adversely affecting the security or the interests of the holders of the debentures and, without affecting the generality of subsection (1), shall state—

(a) whether or not the limitations on the amount that the entity may borrow have been exceeded;

(b) whether or not the borrowing entity and each of its guarantor entities have observed and performed all the covenants and provisions binding upon them respectively by or pursuant to the debentures or any trust deed;

(c) whether or not any event has happened which has caused or could cause the debentures or any provision of the relevant trust deed to become enforceable and, if so, particulars of that event;

(d) whether or not any circumstances affecting the borrowing entity, its subsidiaries or its guarantor entities or any of them have occurred which materially affect any security or charge included in or created by the debentures or any trust deed and, if so, particulars of those circumstances;

(e) whether or not there has been any substantial change in the nature of the business of the borrowing entity or any of its subsidiaries or any of its guarantor entities since the debentures were first issued which has not previously been reported upon as required by this section and, if so, particulars of that change; and

(f) where the borrowing entity has deposited money with or lent money to or assumed any liability of a corporation which is related to the borrowing entity, particulars of—

(i) the total amounts so deposited or lent and the extent of any liability so assumed during the period covered by the report; and

(ii) the total amounts owing to the borrowing entity in respect of money so deposited or lent and the extent of any liability so assumed as at the end of the period covered by the report,

distinguishing between deposits, loans and assumptions of liabilities which are secured and those which are unsecured, but not including any deposit with or loan to or any liability assumed on behalf of a corporation if that corporation has guaranteed the repayment of the debentures of the borrowing entity and has secured the guarantee by a charge over its assets in favour of the trustee for the holders of the debentures of the borrowing entity.

[1/2005]

(3) Any person who fails to comply with subsection (1) shall be guilty of an offence and shall be liable on conviction to a fine not exceeding \$20,000 and, in the case of a continuing offence, to a further fine not exceeding \$2,000 for every day or part thereof during which the offence continues after conviction.

(4) Where there is a trustee for the holders of any debentures issued by a borrowing entity, the borrowing entity and each of its guarantor entities which has guaranteed the repayment of the moneys raised by the issue of those debentures shall, whether or not any demand therefor has been made—

(a) in writing furnish the trustee, within 21 days after the creation of the charge, with the particulars of any charge created by the entity or the guarantor entity, as the case requires; and

(b) when the amount to be advanced on the security of the charge is indeterminate, in writing furnish the trustee, within 7 days after the advance, with particulars of the amount or amounts in fact advanced.

[1/2005]

(5) Where any such advance referred to in subsection (4) (b) is merged in a current account with bankers or trade creditors, it shall be sufficient for particulars of the net amount outstanding in respect of any such advance to be furnished every 3 months.

(6) The directors or equivalent persons of every borrowing entity and of every guarantor entity shall cause to be made out and lodged with the Authority and with the trustee for the holders of the debentures, if any—

(a) a profit and loss account for the first 6 months of every financial year of the entity and a balance-sheet as at the end of that period, not later than 3 months after the expiration of the period of 6 months; and

(b) a profit and loss account for every financial year of the entity and a balance-sheet as at the end of that period, not later than 5 months after the expiration of that financial year.

[1/2005]

(7) Any person who fails to comply with subsection (6) shall be guilty of an offence and shall be liable on conviction to a fine not exceeding \$15,000

continued on next page

Box A1.1 continuation

and, in the case of a continuing offence, to a further fine not exceeding \$1,000 for every day or part thereof during which the offence continues after conviction.

(8) Section 201 (4) to (7) and (11) to (16) and section 207 (1), (2) and (7) of the Companies Act (Cap. 50), shall, with such adaptations as are necessary, be applicable to every profit and loss account and balance-sheet made out and lodged under subsection (6) as if that profit and loss account and balance-sheet were a profit and loss account and balance-sheet referred to in those sections.

(9) Where—

(a) the directors or equivalent persons of a borrowing entity do not lodge with the trustee for the holders of debentures a report as required by subsection (1); or

(b) the directors or equivalent persons of a borrowing entity or the directors of a guarantor entity do not lodge with the trustee the balance-sheets and profit and loss accounts as required by subsection (6) within the time prescribed, the trustee shall immediately lodge notice of that fact with the Authority.

[1/2005]

(10) Notwithstanding anything in subsection (8)—

(a) a profit and loss account and balance-sheet of a borrowing entity or its guarantor entity required to be made out and lodged in accordance with subsection (6)(a) need not be audited; and

(b) a profit and loss account and balance-sheet of a borrowing entity or its guarantor entity required to be made out and lodged in accordance with subsection (6)(b) need not be audited, or the audit thereof may be of a limited nature or extent, if the trustee for the holders of the debentures of the borrowing entity has, by notice in writing, consented to the audit being dispensed with or being of a limited nature or extent, as the case may be.

(11) Where the trustee has by notice in writing given his consent under subsection (10), the directors or equivalent persons of the borrowing entity, or the directors or equivalent persons of the guarantor entity, in respect of whose profit and loss account and balance-sheet the notice was given, shall lodge with the Authority a copy of the notice at the time when the profit and loss account and balance-sheet to which the notice relates are lodged with the Authority.

[1/2005]

(12) Notwithstanding anything in this section, a profit and loss account and balance-sheet of a borrowing entity or its guarantor entity required to be made out and lodged in accordance with subsection (6) may, unless the trustee for the holders of the debentures of the borrowing entity otherwise requires in writing, be based upon the value of the stock in trade of the borrowing entity or the guarantor entity, as the case may be, as reasonably estimated by the directors or equivalent persons of the borrowing entity or guarantor entity.

[1/2005]

(13) The estimation of the directors or equivalent persons referred to in subsection (12) shall be made on the basis of the values of such stock in trade as adopted for the purpose of the profit and loss account and balance-sheet of that entity laid before the entity at its last preceding annual general meeting and certified in writing by the directors or equivalent persons as such.

[1/2005]

[Companies, s. 103]

Obligation of guarantor entity to furnish information

269.—(1) For the purpose of the preparation of a report that, by this Subdivision, is required to be signed by or on behalf of the directors or equivalent persons, or persons approved by the Authority, of a borrowing entity or any of them, that borrowing entity may, by notice in writing, require any of its guarantor entities to furnish it with any information relating to that guarantor entity which is, by this Subdivision, required to be contained in that report.

[1/2005]

(2) The guarantor entity shall furnish the borrowing entity with the information required under subsection (1) before such date, being a date not earlier than 14 days after the notice is given, as may be specified in that behalf in the notice.

[1/2005]

(3) A guarantor entity which fails to comply with a requirement contained in a notice given under subsection (1) and every officer or equivalent person of that entity who is in default shall be guilty of an offence and shall be liable on conviction to a fine not exceeding \$20,000 and, in the case of a continuing offence, to a further fine not exceeding \$2,000 for every day or part thereof during which the offence continues after conviction.

[1/2005]

[Companies, s. 104]

Loans and deposits to be immediately repayable on certain events

270.—(1) Where there is, in any prospectus issued in connection with an offer of debentures, a statement as to any particular purpose or project for which the moneys received by the borrowing entity in response to the offer are to be applied, the borrowing entity shall, where there is a trustee for the holders of those debentures, from time to time make reports to the trustee as to the progress that has been made towards achieving such purpose or completing such project.

[16/2003;1/2005]

(2) Each such report shall be included in the report required to be furnished to the trustee for the holders of the debentures under section 268 (1).

(3) When it appears to the trustee for the holders of the debentures that such purpose or project has not been achieved or completed—

(a) within the time stated in the prospectus within which the purpose or project is to be achieved or completed; or

(b) where no such time was stated, within a reasonable time,

the trustee may and, if in his opinion it is necessary for the protection of the interests of the holders of the debentures, shall give notice in writing to the borrowing entity requiring it to repay the moneys so received by the borrowing entity and, within one month after such notice is given, lodge with the Authority a copy thereof.

continued on next page

Box A1.1 continuation

[1/2005]

(4) The trustee shall not give notice under subsection (3) if he is satisfied—

- (a) that the purpose or project has been substantially achieved or completed;
- (b) that the interests of the holders of debentures have not been materially prejudiced by the failure to achieve or complete the purpose or project within the time stated in the prospectus or within a reasonable time; or
- (c) that the failure to achieve the purpose or project was due to circumstances beyond the control of the borrowing entity that could not reasonably have been foreseen by the borrowing entity at the time that the prospectus was issued.

[1/2005]

(5) Upon receipt by the borrowing entity of a notice referred to in subsection (3), the borrowing entity shall be liable to repay, and on demand in writing by a person entitled thereto shall immediately repay to him any moneys owing to him as the result of a loan or deposit made in response to the offer unless—

- (a) before the moneys were accepted by the borrowing entity, the borrowing entity had given notice in writing to the persons from whom the moneys were received specifying the purpose or project for which the moneys would in fact be used and the moneys were accepted by the borrowing entity accordingly; or
- (b) the borrowing entity by notice in writing served on the holders of the debentures—
 - (i) had specified the purpose or project for which the moneys would in fact be applied by the borrowing entity; and
 - (ii) had offered to repay the moneys to the holders of the debentures, and that person had not within 14 days after the receipt of the notice, or such longer time as was specified in the notice, in writing demanded from the borrowing entity repayment of the money.

[1/2005]

(6) Where the borrowing entity has given a notice in writing as provided in subsection (5), specifying the purpose or project for which the moneys will in fact be applied by the borrowing entity, this section shall apply and have effect as if the purpose or project so specified in the notice was the particular purpose or project specified in the prospectus as the purpose or project for which the moneys were to be applied.

[1/2005]

[Companies, s. 105]

Liability of trustees for debenture holders

271.—(1) Subject to this section, any provision contained in a trust deed relating to or securing an issue of debentures, or in any contract with the holders of debentures secured by a trust deed, shall be void in so far as it would have the effect of exempting a trustee thereof from or indemnifying him against liability for breach of trust where he fails to show the degree of care and diligence required of him as trustee.

(2) Subsection (1) shall not invalidate—

- (a) any release otherwise validly given in respect of anything done or omitted to be done by a trustee before the giving of the release; or
- (b) any provision enabling such a release to be given—
 - (i) on the agreement thereto of a majority of not less than three fourths in nominal value of the debenture holders present and voting in person or, where proxies are permitted, by proxy at a meeting summoned for the purpose; and
 - (ii) either with respect to specific acts or omissions or on the dissolution of the trustee or on his ceasing to act.

(3) Subsection (1) shall not operate—

- (a) to invalidate any provision in force on 29th December 1967 so long as any trustee then entitled to the benefit of that provision remains a trustee of the deed in question; or
- (b) to deprive any trustee of any exemption or right to be indemnified in respect of anything done or omitted to be done by the trustee while any such provision was in force.

[Companies, s. 106]

Subdivision (4)—Exemptions

Issue or transfer of securities for no consideration

272.—(1) Subdivisions (2) and (3) of this Division (other than section 257) shall not apply to an offer of shares or debentures of an entity if no consideration is or will be given for the issue or transfer of the shares or debentures.

[1/2005]

(2) Subdivisions (2) and (3) of this Division (other than section 257) shall not apply to an offer of units of shares or debentures of an entity if—

- (a) no consideration is or will be given for the issue or transfer of the units of shares or debentures; and
- (b) no consideration is or will be given for the underlying shares or debentures on the exercise or conversion of the units of shares or debentures.

[1/2005]

Small offers

272A.—(1) Subdivisions (2) and (3) of this Division (other than section 257) shall not apply to personal offers of securities of an entity by a person if—

- (a) the total amount raised by the person from such offers within any period of 12 months does not exceed—
 - (i) \$5 million (or its equivalent in a foreign currency); or
 - (ii) such other amount as may be prescribed by the Authority in substitution for the amount specified in sub-paragraph (i);
- (b) in respect of each offer, the person making the offer gives the person to whom he makes the offer—
 - (i) the following statement in writing:

“This offer is made in reliance on the exemption under section 272A (1) of the Securities and Futures Act. It is not made in or accompanied by a prospectus that is registered by the Monetary Authority of Singapore.”; and

- (ii) a notification in writing that the securities to which the offer (referred to in this sub-paragraph as the initial offer) relates shall not be subsequently sold

continued on next page

Box A1.1 continuation

to any person, unless the offer resulting in such subsequent sale is made—

- (A) in compliance with Subdivisions (2) and (3) of this Division;
- (B) in reliance on subsection (8) (c) or any other exemption under any provision of this Subdivision (other than this subsection); or
- (C) where at least 6 months have elapsed from the date the securities were acquired under the initial offer, in reliance on the exemption under this subsection;
- (c) none of the offers is accompanied by an advertisement making an offer or calling attention to the offer or intended offer;
- (d) no selling or promotional expenses are paid or incurred in connection with each offer other than those incurred for administrative or professional services, or by way of commission or fee for services rendered by—
 - (i) the holder of a capital markets services licence to deal in securities;
 - (ii) an exempt person in respect of dealing in securities; or
 - (iii) a person who is licensed, approved, authorised or otherwise regulated under the laws, codes or other requirements of any foreign jurisdiction in respect of dealing in securities, or who is exempted therefrom in respect of such dealing; and

[1/2005]

(e) no prospectus in respect of any of the offers has been registered by the Authority or, where a prospectus has been registered—

- (i) the prospectus has expired pursuant to section 250; or
- (ii) the person making the offer has before making the offer informed the Authority by notice in writing of its intent to make the offer in reliance on the exemption under this subsection.

(2) For the purposes of subsection (1) (b), where any notice, circular, material, publication or other document is issued in connection with the offer, the person making the offer is deemed to have given the statement and notification to the person to whom he makes the offer in accordance with that provision if such statement or notification is contained in the first page of that notice, circular, material, publication or document.

[1/2005]

(3) For the purposes of subsection (1), a personal offer of securities is one that—

- (a) may be accepted only by the person to whom it is made; and
- (b) is made to a person who is likely to be interested in that offer, having regard to—
 - (i) any previous contact before the date of the offer between the person making the offer and that person;
 - (ii) any previous professional or other connection established before that date between the person making the offer and that person; or
 - (iii) any previous indication (whether through statements made or actions carried out) before that date by that person that indicate to—
 - (A) the person making the offer;
 - (B) the holder of a capital markets services licence to deal in securities;
 - (C) an exempt person in respect of dealing in securities;
 - (D) a person licensed under the Financial Advisers Act (Cap. 110) in respect of the provision of financial advisory services concerning investment products;
 - (E) an exempt financial adviser as defined in section 2 (1) of the Financial Advisers Act; or
 - (F) a person who is licensed, approved, authorised or otherwise regulated under the laws, codes or other requirements of any foreign jurisdiction in respect of dealing in securities or the provision of financial advisory services concerning investment products, or who is exempted therefrom in respect of such dealing or the provision of such services, that he is interested in offers of that kind.

[1/2005]

(4) In determining the amount raised by an offer, the following shall be included:

- (a) the amount payable for the securities at the time they are allotted, issued or sold;
- (b) if the securities are issued partly-paid, any amount payable at a future time if a call is made;
- (c) if the securities carry a right (by whatever name called) to be converted into other securities or to acquire other securities, any amount payable on the exercise of the right to convert them into, or to acquire, other securities.

[1/2005]

(5) In determining whether the amount raised by a person from offers within a period of 12 months exceeds the applicable amount specified in subsection (1) (a), each amount raised—

- (a) by that person from any offer of securities issued by the same entity; or
 - (b) by that person or another person from any offer of securities of an entity, units or derivatives of units in a business trust, or units in a collective investment scheme, which is a closely related offer,
- if any, within that period in reliance on the exemption under subsection (1), section 282V (1) or 302B (1) shall be included.

[1/2005]

(6) Whether an offer is a closely related offer under subsection (5) shall be determined by considering such factors as the Authority may prescribe.

[1/2005]

(7) For the purpose of this section, an offer of securities made by a person acting as an agent of another person shall be treated as an offer made by that other person.

[1/2005]

(8) Where securities acquired through an offer made in reliance on the exemption under subsection (1) (referred to in this subsection as an initial offer) are subsequently sold by the person who acquired the securities to another person, Subdivisions (2) and (3) of this Division shall apply to the offer from the first-mentioned person to the second-mentioned person which resulted in that sale, unless—

- (a) such offer is made in reliance on an exemption under any provision of this Subdivision (other than this section);
- (b) such offer is made in reliance on an exemption under subsection (1) and at least 6 months have elapsed from the date the securities were acquired under the initial offer; or

continued on next page

Box A1.1 continuation

(c) such offer is one—

(i) that may be accepted only by the person to whom it is made;

(ii) that is made to a person who is likely to be interested in the offer having regard to—

(A) any previous contact before the date of the offer between the person making the initial offer and that person;

(B) any previous professional or other connection established before that date between the person making the initial offer and that person; or

(C) any previous indication (whether through statements made or actions carried out) before that date by that person that indicate to—

(CA) the person making the initial offer;

(CB) the holder of a capital markets services licence to deal in securities;

(CC) an exempt person in respect of dealing in securities;

(CD) a person licensed under the Financial Advisers Act (Cap. 110) in respect of the provision of financial advisory services concerning investment products;

(CE) an exempt financial adviser as defined in section 2 (1) of the Financial Advisers Act; or

(CF) a person who is licensed, approved, authorised or otherwise regulated under the laws, codes or other requirements of any foreign jurisdiction in respect of dealing in securities or the provision of financial advisory services concerning investment products, or who is exempted therefrom in respect of such dealing or the provision of such services,

that he is interested in offers of that kind;

(iii) in respect of which the first-mentioned person has given the second-mentioned person—

(A) the following statement in writing:

“This offer is made in reliance on the exemption under section 272A (8) (c) of the Securities and Futures Act. It is not made in or accompanied by a prospectus that is registered by the Monetary Authority of Singapore.”; and

(B) a notification in writing that the securities being offered shall not be subsequently sold to any person unless the offer resulting in such subsequent sale is made—

(BA) in compliance with Subdivisions (2) and (3) of this Division;

(BB) in reliance on this subsection or any other exemption under any provision of this Subdivision (other than subsection (1)); or

(BC) where at least 6 months have elapsed from the date the securities were acquired under the initial offer, in reliance on the exemption under subsection (1);

(iv) that is not accompanied by an advertisement making an offer or calling attention to the offer or intended offer; and

(v) in respect of which no selling or promotional expenses are paid or incurred in connection with the offer other than those incurred for administrative or professional services, or by way of commission or fee for services rendered by—

(A) the holder of a capital markets services licence to deal in securities;

(B) an exempt person in respect of dealing in securities; or

(C) a person who is licensed, approved, authorised or otherwise regulated under the laws, codes or other requirements of any foreign jurisdiction in respect of dealing in securities, or who is exempted therefrom in respect of such dealing.

[1/2005]

(9) Subsection (2) shall apply, with the necessary modifications, in relation to the statement and notification referred to in subsection (8) (c) (iii).

[1/2005]

(10) In subsections (1) (c) and (8) (c) (iv), “advertisement” means—

(a) a written or printed communication;

(b) a communication by radio, television or other medium of communication; or

(c) a communication by means of a recorded telephone message, that is published in connection with an offer of securities, but does not include—

(i) a document—

(A) purporting to describe the securities being offered, or the business and affairs of the person making the offer, the issuer or, where applicable, the underlying entity; and

(B) purporting to have been prepared for delivery to and review by persons to whom the offer is made so as to assist them in making an investment decision in respect of the securities being offered;

(ii) a publication which consists solely of a disclosure, notice or report required under this Act, or any listing rules or other requirements of a securities exchange, futures exchange or overseas securities exchange, which is made by any person; or

(iii) a publication which consists solely of a notice or report of a general meeting or proposed general meeting of the person making the offer, the issuer, the underlying entity or any entity, or a presentation of oral or written material on matters so contained in the notice or report at the general meeting.

[1/2005]

(11) In subsection (10) (i) (A), the reference to the affairs of the person making the offer, the issuer or, where applicable, the underlying entity shall—

(a) in the case where the person making the offer, the issuer or the underlying entity is a corporation, be construed as including a reference to the matters referred to in section 2 (2); and

(b) in any other case, be construed as referring to such matters as may be prescribed by the Authority.

[1/2005]

Private placement

272B.—(1) Subdivisions (2) and (3) of this Division (other than section 257) shall not apply to offers of securities of an entity that are made by a person if—

(a) the offers are made to no more than 50 persons within any period of 12 months;

(b) none of the offers is accompanied by an advertisement making an offer or calling attention to the offer or intended offer;

continued on next page

Box A1.1 continuation

(c) no selling or promotional expenses are paid or incurred in connection with each offer other than those incurred for administrative or professional services, or by way of commission or fee for services rendered by—

- (i) the holder of a capital markets services licence to deal in securities;
- (ii) an exempt person in respect of dealing in securities; or
- (iii) a person who is licensed, approved, authorised or otherwise regulated under the laws, codes or other requirements of any foreign jurisdiction in respect of dealing in securities, or who is exempted therefrom in respect of such dealing; and

[1/2005]

(d) no prospectus in respect of any of the offers has been registered by the Authority or, where a prospectus has been registered—

- (i) the prospectus has expired pursuant to section 250; or
- (ii) the person making the offer has before making the offer—
 - (A) informed the Authority by notice in writing of its intent to make the offer in reliance on the exemption under this subsection; and
 - (B) taken reasonable steps to inform in writing the person to whom the offer is made that the offer is made in reliance on the exemption under this subsection.

(2) The Authority may prescribe such other number of persons in substitution for the number specified in subsection (1) (a).

[1/2005]

(3) In determining whether offers of securities by a person are made to no more than the applicable number of persons specified in subsection (1) (a) within a period of 12 months, each person to whom—

- (a) an offer of securities issued by the same entity is made by the first-mentioned person; or
 - (b) an offer of securities of an entity, units or derivatives of units in a business trust, or units in a collective investment scheme, is made by the first-mentioned person or another person where such offer is a closely related offer,
- if any, within that period in reliance on the exemption under this section, section 282W or 302C shall be included.

[1/2005]

(4) Whether an offer is a closely related offer under subsection (3) shall be determined by considering such factors as the Authority may prescribe.

[1/2005]

(5) For the purposes of subsection (1)—

- (a) an offer of securities to an entity or to a trustee shall be treated as an offer to a single person, provided that the entity or trust is not formed primarily for the purpose of acquiring the securities which are the subject of the offer;
 - (b) an offer of securities to an entity or to a trustee shall be treated as an offer to the equity owners, partners or members of that entity, or to the beneficiaries of the trust, as the case may be, if the entity or trust is formed primarily for the purpose of acquiring the securities which are the subject of the offer;
 - (c) an offer of securities to 2 or more persons who will own the securities acquired as joint owners shall be treated as an offer to a single person;
 - (d) an offer of securities to a person acting on behalf of another person (whether as an agent or otherwise) shall be treated as an offer made to that other person;
 - (e) offers of securities made by a person as an agent of another person shall be treated as offers made by that other person;
 - (f) where an offer is made to a person with a view to another person acquiring an interest in those securities by virtue of section 4, only the second-mentioned person shall be counted for the purposes of determining whether offers of the securities are made to no more than the applicable number of persons specified in subsection (1) (a); and
 - (g) where—
 - (i) an offer of securities is made to a person in reliance on the exemption under subsection (1) with a view to those securities being subsequently offered for sale to another person; and
 - (ii) that subsequent offer—
 - (A) is not made in reliance on an exemption under any provision of this Subdivision; or
 - (B) is made in reliance on an exemption under subsection (1) or section 280,
- both persons shall be counted for the purposes of determining whether offers of the securities are made to no more than the applicable number of persons specified in subsection (1) (a).

[1/2005]

(6) In subsection (1) (b), “advertisement” has the same meaning as in section 272A (10).

[1/2005]

Offer made under certain circumstances

273.—(1) Subdivisions (2) and (3) of this Division (other than section 257) shall not apply to an offer of securities if—

- (a) it is made in connection with a take-over offer which is in compliance with the Take-over Code;
- (b) it is made in connection with an offer for the acquisition by or on behalf of a person of some or all of the shares in an unlisted corporation or some or all of the shares of a particular class in an unlisted corporation—
 - (i) to all members of the corporation or all members of the corporation holding shares of that class; or
 - (ii) where the person already holds shares in the corporation, to all other members of the corporation or all other members of the corporation holding shares of that class,

where such offer is in compliance with the laws, codes and other requirements (whether or not having the force of law) relating to take-overs of the country in which the corporation was incorporated;

(c) it is made in connection with a proposed compromise or arrangement between—

- (i) an unlisted corporation and its creditors or a class of them; or

continued on next page

Box A1.1 continuation

- (ii) an unlisted corporation and its members or a class of them, and such proposed compromise or arrangement and the execution thereof is in compliance with the laws, codes and other requirements (whether or not having the force of law) relating to take-overs, compromises and arrangements of the country in which the corporation was incorporated;
- (ca) it is made in connection with an offer for the acquisition by or on behalf of a person of some or all of the shares in a corporation or some or all of the shares of a particular class in a corporation—
- (i) to all members of the corporation or all members of the corporation holding shares of that class; or
- (ii) where the person already holds shares in the corporation, to all other members of the corporation or all other members of the corporation holding shares of that class,
- and such offer complies with the Take-over Code as though the Take-over Code is applicable to it;
- (cb) it is made in connection with a proposed compromise or arrangement between—
- (i) a corporation and its creditors or a class of them; or
- (ii) a corporation and its members or a class of them, and such proposed compromise or arrangement and the execution thereof complies with the Take-over Code as though the Take-over Code is applicable to it;
- (cc) it is an offer to enter into an underwriting agreement relating to securities;
- (cd) it is an offer of securities of an entity—
- (i) being an entity which is formed or constituted in Singapore or otherwise, whose securities are not listed for quotation on a securities exchange; or
- (ii) being an entity which is not formed or constituted in Singapore, whose securities are listed for quotation on a securities exchange and such listing is not a primary listing, that is made to existing members or debenture holders of that entity (whether or not it is renounceable in favour of persons other than existing members or debenture holders);
- (ce) it is an offer of shares or debentures of an entity made to any existing member or debenture holder of the entity whose shares are listed for quotation on a securities exchange;
- (cf) it is an offer of debentures of an entity made to any existing debenture holder of the entity whose debentures are listed for quotation on a securities exchange;
- (cg) it is an offer of units of shares or debentures of an entity made to any existing member or debenture holder of the entity whose shares are listed for quotation on a securities exchange, where such units may only be exercised or converted by any existing member or debenture holder into shares or debentures, as the case may be, of the entity;
- (ch) it is an offer of units of debentures of an entity made to any existing debenture holder of the entity whose debentures are listed on a securities exchange, where such units may only be exercised or converted by any existing debenture holder into debentures of the entity;
- (ci) it is an offer of securities of a corporation made in the circumstances specified under section 306 of the Companies Act (Cap. 50);
- (d) it is an offer of shares or debentures (not being such excluded shares or excluded debentures as may be prescribed by the Authority) that have been previously issued, are listed for quotation or quoted on a securities exchange, and are traded on the exchange;
- (e) it is an offer of units of shares or debentures (not being such excluded units of shares or debentures as may be prescribed by the Authority) where—
- (i) the units of shares or debentures have been previously issued, are listed for quotation or quoted on a securities exchange, and are traded on the exchange; or
- (ii) an application has been or will be made for permission for the units of shares or debentures to be listed for quotation or quoted on a securities exchange and the shares or debentures have been previously issued and are listed for quotation on a securities exchange or a recognised securities exchange; or
- (f) it is made (whether or not in relation to securities that have been previously issued) by an entity to a qualifying person, where the securities are to be held by or for the benefit of the qualifying person and are the securities of the entity or any of its related parties.

[16/2003;1/2005]

(1A) An offer of securities does not come within subsection (1) (d) or (e) if—

- (a) the securities being offered are borrowed by the issuer from an existing shareholder, holder of a debenture, or holder of units of shares or debentures, solely for the purpose of facilitating the offer of securities by the issuer; and
- (b) such borrowing is made under an agreement or arrangement between the issuer and the shareholder or holder which promises the issue or allotment of securities by the issuer to the shareholder or holder at the same time or shortly after the offer.

[1/2005]

(2) An offer of securities comes within subsection (1) (f) only if no selling or promotional expenses are paid or incurred in connection with the offer other than those incurred for administrative or professional services, or by way of commission or fee for services rendered by—

- (a) the holder of a capital markets services licence to deal in securities;
- (b) an exempt person in respect of dealing in securities; or
- (c) a person who is licensed, approved, authorised or otherwise regulated under the laws, codes or other requirements of any foreign jurisdiction in respect of dealing in securities, or who is exempted therefrom in respect of such dealing.

[1/2005]

(3) *(Deleted by Act 1/2005)*

(4) For the purposes of subsection (1) (f), a person is a qualifying person in relation to an entity if he is a bona fide director or equivalent person, former director or equivalent person, consultant, adviser, employee or former employee of the entity or a related corporation of that entity (being a corporation), or if he is the spouse, widow, widower or a child, adopted child or step-child below the age of 18, of such director or equivalent person, former director or equivalent person, employee or former employee.

[1/2005]

(5) Where, on the application of any person interested, the Authority declares that circumstances exist whereby—

- (a) the cost of providing a prospectus for an offer of securities outweighs the resulting protection to investors; or

continued on next page

Box A1.1 continuation

(b) it would not be prejudicial to the public interest if a prospectus were dispensed with for an offer of securities, then Subdivisions (2) and (3) of this Division (other than section 257) shall not apply to such an offer for a period of 6 months from the date of the declaration.

[1/2005]

(6) The Authority may, on making a declaration under subsection (5), impose such conditions or restrictions on the offer as it may determine.

[16/2003;1/2005]

(7) A declaration made under subsection (5) shall be final.

[16/2003]

(8) Any person who contravenes any of the conditions or restrictions specified in the declaration made under subsection (5) shall be guilty of an offence and shall be liable on conviction to a fine not exceeding \$50,000 and, in the case of a continuing offence, to a further fine not exceeding \$5,000 for every day or part thereof during which the offence continues after conviction.

[16/2003]

(9) In subsection (1) (b) and (c), "unlisted corporation" means a corporation—

(a) that is not a company; and

(b) the securities of which are not listed for quotation on any securities exchange.

[1/2005]

(10) In subsection (1) (ca) and (cb), "corporation" means a corporation that is not a company.

[1/2005]

[Companies, s. 106B]

Offer made to institutional investors

274. Subdivisions (2) and (3) of this Division (other than section 257) shall not apply to an offer of securities, whether or not they have been previously issued, made to an institutional investor.

[1/2005]

[Companies, s. 106C]

Offer made to accredited investors and certain other persons

275.—(1) Subdivisions (2) and (3) of this Division (other than section 257) shall not apply to an offer of securities, whether or not they have been previously issued, where the offer is made to a relevant person, if—

(a) the offer is not accompanied by an advertisement making an offer or calling attention to the offer or intended offer;

(b) no selling or promotional expenses are paid or incurred in connection with the offer other than those incurred for administrative or professional services, or by way of commission or fee for services rendered by—

(i) the holder of a capital markets services licence to deal in securities;

(ii) an exempt person in respect of dealing in securities; or

(iii) a person who is licensed, approved, authorised or otherwise regulated under the laws, codes or other requirements of any foreign jurisdiction in respect of dealing in securities, or who is exempted therefrom in respect of such dealing; and

[1/2005]

(c) no prospectus in respect of the offer has been registered by the Authority or, where a prospectus has been registered—

(i) the prospectus has expired pursuant to section 250; or

(ii) the person making the offer has before making the offer—

(A) informed the Authority by notice in writing of its intent to make the offer in reliance on the exemption under this subsection; and

(B) taken reasonable steps to inform in writing the person to whom the offer is made that the offer is made in reliance on the exemption under this subsection.

(1A) Subdivisions (2) and (3) of this Division (other than section 257) shall not apply to an offer of securities to a person who acquires the securities as principal, whether or not the securities have been previously issued, if—

(a) the offer is on terms that the securities may only be acquired at a consideration of not less than \$200,000 (or its equivalent in a foreign currency) for each transaction, whether such amount is to be paid for in cash or by exchange of securities or other assets;

(b) the offer is not accompanied by an advertisement making an offer or calling attention to the offer or intended offer;

(c) no selling or promotional expenses are paid or incurred in connection with the offer other than those incurred for administrative or professional services, or by way of commission or fee for services rendered by—

(i) the holder of a capital markets services licence to deal in securities;

(ii) an exempt person in respect of dealing in securities; or

(iii) a person who is licensed, approved, authorised or otherwise regulated under the laws, codes or other requirements of any foreign jurisdiction in respect of dealing in securities, or who is exempted therefrom in respect of such dealing; and

[1/2005]

(d) no prospectus in respect of the offer has been registered by the Authority or, where a prospectus has been registered—

(i) the prospectus has expired pursuant to section 250; or

(ii) the person making the offer has before making the offer—

(A) informed the Authority by notice in writing of its intent to make the offer in reliance on the exemption under this subsection; and

(B) taken reasonable steps to inform in writing the person to whom the offer is made that the offer is made in reliance on the exemption under this subsection.

continued on next page

Box A1.1 continuation

(2) In this section—

“advertisement” means—

(a) a written or printed communication;

(b) a communication by radio, television or other medium of communication; or

(c) a communication by means of a recorded telephone message,

that is published in connection with an offer in respect of securities, but does not include—

(i) an information memorandum;

(ii) a publication which consists solely of a disclosure, notice or report required under this Act, or any listing rules or other requirements of a securities exchange, futures exchange or overseas securities exchange, which is made by any person; or

(iii) a publication which consists solely of a notice or report of a general meeting or proposed general meeting of the person making the offer, the issuer, the underlying entity or any entity, or a presentation of oral or written material on matters so contained in the notice or report at the general meeting;

“information memorandum” means a document—

(a) purporting to describe the securities being offered, or the business and affairs of the person making the offer, the issuer or, where applicable, the underlying entity; and

(b) purporting to have been prepared for delivery to and review by relevant persons and persons to whom an offer referred to in subsection (1A) is to be made so as to assist them in making an investment decision in respect of the securities being offered; “relevant person” means—

(a) an accredited investor;

(b) a corporation the sole business of which is to hold investments and the entire share capital of which is owned by one or more individuals, each of whom is an accredited investor;

(c) a trustee of a trust the sole purpose of which is to hold investments and each beneficiary of which is an individual who is an accredited investor;

(d) an officer or equivalent person of the person making the offer (such person being an entity) or a spouse, parent, brother, sister, son or daughter of that officer or equivalent person; or

(e) a spouse, parent, brother, sister, son or daughter of the person making the offer (such person being an individual).

[1/2005]

(2A) In the definition of “information memorandum” in subsection (2), the reference to the affairs of the person making the offer, the issuer or, where applicable, the underlying entity shall—

(a) in the case where the person making the offer, the issuer or the underlying entity is a corporation, be construed as including a reference to the matters referred to in section 2 (2); and

(b) in any other case, be construed as referring to such matters as may be prescribed by the Authority.

[1/2005]

(3) Notwithstanding any requirement in section 99 or any regulation made thereunder that a person has to deal in securities for his own account with or through a person prescribed by the Authority so that he can qualify as an exempt person, a person who acquires securities under section 274 or this section for his own account shall be considered an exempt person even though he does not comply with that requirement.

[1/2005]

(4) The Authority may, by order published in the *Gazette*, specify an amount in substitution of any amount specified in subsection (1A) (a).

[1/2005]

[Companies, s. 106D]

Offer of securities acquired pursuant to section 274 or 275

276.—(1) Notwithstanding sections 272A, 272B, 273 (1) (d), (e) and (f), 277, 278 and 279 but subject to subsection (7), where securities initially acquired pursuant to an offer made in reliance on an **exemption** under section 274 or 275 are sold within the period of 6 months from the date of the initial acquisition to any person other than—

(a) an institutional investor;

(b) a relevant person as defined in section 275 (2); or

(c) any person pursuant to an offer referred to in section 275 (1A),

then Subdivisions (2) and (3) of this Division shall apply to the offer resulting in that sale.

[1/2005]

(1A) The reference to the sale of securities under subsection (1) shall, in a case where the securities initially acquired are debentures, or units of shares or debentures, with an attached right of conversion into shares or debentures, include a reference to the sale of the converted shares or debentures.

(2) Where securities initially acquired pursuant to an offer made in reliance on an exemption under section 274 or 275 are sold to—

(a) an institutional investor;

(b) a relevant person as defined in section 275 (2); or

(c) any person pursuant to an offer referred to in section 275 (1A),

Subdivisions (2) and (3) of this Division shall not apply to the offer resulting in that sale.

[1/2005]

(3) Subject to subsection (7), securities of a corporation (other than a corporation that is an accredited investor)—

(a) the sole business of which is to hold investments; and

(b) the entire share capital of which is owned by one or more individuals, each of whom is an accredited investor,

shall not be transferred within 6 months after the corporation has acquired any securities pursuant to an offer made in reliance on an exemption under

continued on next page

Box A1.1 continuation

section 275 unless—

- (i) that transfer—
 - (A) is made only to institutional investors or relevant persons as defined in section 275 (2); or
 - (B) arises from an offer referred to in section 275 (1A);
- (ii) no consideration is or will be given for the transfer; or
- (iii) the transfer is by operation of law.

[1/2005]

(4) Subject to subsection (7), where—

- (a) the sole purpose of a trust (other than a trust the trustee of which is an accredited investor) is to hold investments; and
- (b) each beneficiary of the trust is an individual who is an accredited investor, the beneficiaries' rights and interest (howsoever described) in the trust shall not be transferred within 6 months after securities are acquired for the trust pursuant to an offer made in reliance on an exemption under section 275 unless—

- (i) that transfer—
 - (A) is made only to institutional investors or relevant persons as defined in section 275 (2); or
 - (B) arises from an offer that is made on terms that such rights or interest are acquired at a consideration of not less than \$200,000 (or its equivalent in a foreign currency) for each transaction, whether such amount is to be paid for in cash or by exchange of securities or other assets;
- (ii) no consideration is or will be given for the transfer; or
- (iii) the transfer is by operation of law.

[1/2005]

(5) For the avoidance of doubt, the reference to beneficiaries in subsection (4) shall include a reference to unit holders of a business trust and participants of a collective investment scheme.

[1/2005]

(6) For the avoidance of doubt, where any securities are acquired pursuant to an offer made in reliance on an exemption under section 274 or 275, an offer to sell those securities may be made in reliance on an exemption under section 273 (1) (d) or (e) after 6 months have elapsed from the date of the first-mentioned offer.

[1/2005]

[Companies, s. 106E]

- (7) Subsections (1), (3) and (4) shall not apply where the securities of the corporation acquired are of the same class as other securities of the corporation—
 - (a) an offer of which has previously been made in or accompanied by a prospectus; and
 - (b) which are listed for quotation on a securities exchange.

Offer made using offer information statement

277.—(1) Subject to subsection (1A), Subdivisions (2) and (3) of this Division (other than section 257) shall not apply to an offer of securities (not being such securities as may be prescribed by the Authority) issued by an entity whose shares are listed for quotation on a securities exchange, whether by means of a rights issue or otherwise, if—

- (a) in the case where the securities offered are units of shares or debentures, the shares or debentures are those of the entity that issued the units;
- (b) an offer information statement relating to the offer which complies with such form and content requirements as may be prescribed by the Authority is lodged with the Authority; and
- (c) the offer is made in or accompanied by the offer information statement referred to in paragraph (b).

[1/2005]

(1A) Subsection (1) shall apply to an offer of securities referred to therein only for a period of 6 months from the date of lodgment of the offer information statement relating to that offer.

[1/2005]

(2) The Authority may, on the application of any person interested, modify the prescribed form and content of the offer information statement in such manner as is appropriate, subject to such conditions or restrictions as may be determined by the Authority.

[16/2003]

(3) Sections 249, 249A, 253, 254 and 255 shall apply in relation to an offer information statement referred to in subsection (1) as they apply in relation to a prospectus.

[1/2005]

(4) For the purposes of subsection (3)—

- (a) a reference in section 249 or 249A to the registration of the prospectus shall be read as a reference to the lodgment of the offer information statement; and
- (b) a reference in section 253 or 254 to any information or new circumstance required to be included in a prospectus under section 243 shall be read as a reference to any information prescribed under subsection (1) (b).

[16/2003;1/2005]

(5) Where the written consent of an expert is required to be given under section 249 (as applied in relation to an offer information statement under subsection (3)), that written consent shall be lodged with the Authority at the same time as the lodgment of the statement.

[16/2003;1/2005]

(6) Where the written consent of an issue manager or underwriter is required to be given under section 249A (as applied in relation to an offer information statement under subsection (3)), that written consent shall be lodged with the Authority at the same time as the lodgment of the statement.

continued on next page

Box A1.1 continuation

[1/2005]

[Companies, s. 106F]

Offer in respect of international debentures

278.—(1) Subdivisions (2) and (3) of this Division (other than section 257) shall not apply to an offer of debentures, or units of debentures, by a body incorporated in a country outside Singapore where the offer—

(a) is made by the holder of a capital markets services licence to deal in securities or an exempt person under section 99 (1) (a) or (b), to such institutional, professional or business investors as the Authority may, by order in the Gazette, specify, being persons or bodies that appear to the Authority to have sufficient expertise to understand any risk involved in buying or selling those debentures, or units of debentures (whether as principal or agent); and

(b) complies with the conditions specified in subsection (2).

[1/2005]

(2) The conditions referred to in subsection (1) (b) are that—

(a) the debentures, or units of debentures, are denominated in a currency, other than the Singapore dollar, and each debenture, or each unit of debenture, has a face value of at least US\$5,000 or its equivalent in another currency; and

(b) the shares of the issuing corporation are listed on a recognised securities exchange or the offer is guaranteed by a corporation whose shares are listed on a recognised securities exchange.

[1/2005]

(3) The Authority may by order in the Gazette add to, vary or amend the conditions specified in subsection (2).

[Companies, s. 106G]

Offer of debentures made by Government or international financial institutions

279. Subdivisions (2) and (3) of this Division shall not apply to an offer of debentures, or units of debentures, made by or guaranteed by—

(a) the Government; or

(b) an international financial institution in which Singapore holds membership of any class or description, whether or not it holds any share in the share capital of that institution.

[1/2005]

[Companies, s. 106H]

Making offer using automated teller machine or electronic means

280.—(1) Subject to subsection (3) and such requirements as may be prescribed by the Authority, a person making an offer of securities using—

(a) any automated teller machine; or

(b) such other electronic means as may be prescribed by the Authority, is exempted from the requirement under section 240 (1) (a) that the offer be made in or accompanied by a prospectus in respect of the offer or, where applicable, the requirement under section 240 (4) that the offer be made in or accompanied by a profile statement in respect of the offer.

[1/2005]

(2) For the avoidance of doubt, a prospectus which complies with all other requirements of section 240 (1) (a) or, where applicable, a profile statement which complies with all other requirements of section 240 (4) must still be prepared and issued in respect of any offer referred to in subsection (1).

[1/2005]

(3) Subsection (1) shall not apply unless the automated teller machine or prescribed electronic means indicates to a prospective subscriber or buyer—

(a) how he can obtain, or arrange to receive, a copy of the prospectus or, where applicable, profile statement in respect of the offer; and

(b) that he should read the prospectus or, where applicable, profile statement before submitting his application, before enabling him to submit any application to subscribe for or purchase securities.

[1/2005]

Revocation of exemption

281.—(1) Where the Authority considers that a person is contravening, or is likely to contravene, or has contravened any condition or restriction imposed under section 273 (6), or that it is necessary in the public interest or for the protection of investors, it may revoke any exemption under this Subdivision, subject to such conditions as it thinks fit.

[16/2003]

(2) The Authority may revoke an exemption under subsection (1) without giving the person affected by the revocation an opportunity to be heard, but the person may, within 14 days of the revocation, apply to the Authority for the revocation to be reviewed by the Authority, and the revocation shall remain in effect unless it is withdrawn by the Authority.

(3) A revocation made under this section shall be final and conclusive and there shall be no appeal therefrom.

[Companies, s. 106J]

Transactions under exempted offers subject to Division 2 of Part XII of Companies Act and Part XII of this Act

282. For the avoidance of doubt, it is hereby declared that in relation to any transaction carried out under an exempted offer under this Part, nothing in this Part shall limit or diminish any liability which any person may incur in respect of any relevant offence under Division 2 of Part XII of the Companies Act (Cap. 50) or Part XII of this Act or any penalty, award of compensation or punishment in respect of any such offence.

[1/2005]

[Companies, s. 106L]

continued on next page

Box A1.1 continuation

Division 1A—Business Trusts

Subdivision (1)—Interpretation

Preliminary provisions

282A.—(1) In this Division, unless the context otherwise requires—

“chief executive officer”, in relation to a corporation, means any person, by whatever name called, who is in the direct employment of, or acting for or by arrangement with, the corporation, and who is principally responsible for the management and conduct of the business of the corporation;

“control”, in relation to an entity, means the capacity of a person to determine the outcome of decisions on the financial and operating policies of the entity, having regard to—

(a) the influence which the person can, in practice, exert on the entity (as opposed to the rights which the person can exercise in the entity); and
(b) any practice or pattern of behaviour of that person affecting the financial or operating policies of the entity (even if such practice or pattern of behaviour involves a breach of an agreement or a breach of trust), but does not include any capacity of a person to influence decisions on the financial and operating policies of the entity if such influence is required by law or under any contract or order of court to be exercised for the benefit of other persons; “expert” has the same meaning as in section 4 (1) of the Companies Act (Cap. 50);

“immediate family”, in relation to an individual, means the individual’s spouse, son, adopted son, step-son, daughter, adopted daughter, step-daughter, father, step-father, mother, step-mother, brother, step-brother, sister or step-sister; “issuer”, in relation to an offer of units or derivatives of units in a business trust, means—

(a) in the case of units being offered, the trustee of the business trust in its capacity as the trustee that issued or will be issuing such units; or
(b) in the case of derivatives of units being offered, the trustee of the business trust in its capacity as the trustee, or any other entity, that issued or will be issuing such derivatives of units;

“minimum subscription”, in relation to any units or derivatives of units in a business trust offered for subscription, means the amount stated in the prospectus relating to the offer, as the minimum amount which must be raised by the issue of the units or derivatives of units so offered failing which no units or derivatives of units will be allotted or issued;

“preliminary document” means a document which has been lodged with the Authority and is issued for the purpose of determining the appropriate issue or sale price of, and the number of, units or derivatives of units in a business trust or proposed business trust to be issued or sold and which contains the information required to be included in a prospectus under section 282F, except for such information as may be prescribed by the Authority;

“profile statement” means a profile statement referred to in section 282C (4);

“promoter”, in relation to a prospectus issued in connection with a business trust, means a promoter of the business trust who was a party to the preparation of the prospectus or of any relevant portion thereof, but does not include any person by reason only of his acting in a professional capacity;

“prospectus” means any prospectus, notice, circular, material, advertisement, publication or other document used to make an offer of units or derivatives of units in a business trust or proposed business trust and includes any document deemed to be a prospectus under section 282Q, but does not include—

(a) a profile statement; or
(b) any material, advertisement or publication which is authorised by section 282L (other than subsection (5) thereof);

“recognised securities exchange” means a corporation which has been declared by the Authority, by order published in the Gazette, to be a recognised securities exchange for the purposes of this Division;

“related party” means—

(a) in relation to an entity—
(i) a director or equivalent person of the entity;
(ii) the chief executive officer or equivalent person of the entity;
(iii) a person who controls the entity;
(iv) a related corporation;
(v) any other entity controlled by it;
(vi) any other entity controlled by the person referred to in sub-paragraph (iii); and
(vii) a related party of any individual referred to in sub-paragraph (i), (ii) or (iii); and
(b) in relation to an individual—

(i) his immediate family;
(ii) a trustee of any trust of which the individual or any member of the individual’s immediate family is—

(A) a beneficiary; or
(B) where the trust is a discretionary trust, a discretionary object,
when the trustee acts in that capacity; and

(iii) any corporation in which he and his immediate family (whether directly or indirectly) have interests in voting shares of an aggregate of not less than 30% of the votes attached to all voting shares;

“replacement document” means a replacement prospectus or a replacement profile statement referred to in section 282D (1), as the case may be;

“supplementary document” means a supplementary prospectus or a supplementary profile statement referred to in section 282D (1), as the case may be;

“trustee-manager”—

(a) in relation to a registered business trust, has the same meaning as in section 2 of the Business Trusts Act (Cap. 31A); and
(b) in relation to a business trust for which an application for registration has been made under section 4 (1) of the Business Trusts Act, means the person proposed to be named as the trustee-manager in the application made under that section;

“trust deed” has the same meaning as “deed” in section 2 of the Business Trusts Act;

continued on next page

Box A1.1 continuation

“trust property” has the same meaning as in section 2 of the Business Trusts Act.

[1/2005]

(2) For the purposes of this Division, a statement shall be deemed to be included in a prospectus or profile statement if it is contained in any report or memorandum appearing on the face thereof or by reference incorporated therein or issued therewith.

[1/2005]

(3) For the purposes of this Division, a person makes an offer of any units or derivatives of units in a business trust if, and only if, as principal—

- (a) he makes (either personally or by an agent) an offer to any person in Singapore which upon acceptance would give rise to a contract for the issue or sale of those units or derivatives of units by him or another person with whom he has made arrangements for that issue or sale; or
- (b) he invites (either personally or by an agent) any person in Singapore to make an offer which upon acceptance would give rise to a contract for the issue or sale of those units or derivatives of units by him or another person with whom he has made arrangements for that issue or sale.

[1/2005]

(4) In subsection (3), “sale” includes any disposal for valuable consideration.

[1/2005]

[SFA, s. 239]

Division not to apply to certain business trusts which are collective investment schemes

282B. This Division does not apply to an offer of units or derivatives of units in a business trust, where—

- (a) the business trust is also a collective investment scheme that has been authorised under section 286 or recognised under section 287; or
- (b) the business trust is also a collective investment scheme and the offer is made in reliance on an exemption under Subdivision (4) of Division 2.

[1/2005]

Modification of provisions to certain offers

282BA. The Authority may, if it thinks it necessary in the interest of the public or a section of the public or for the protection of investors, by regulations modify or adapt the provisions of this Division in their application to such offer of units or derivatives of units in a business trust as may be prescribed, and the provisions of this Division shall apply to such offer subject to such modifications or adaptations.

Subdivision (2)—Prospectus requirements

Requirement for prospectus and profile statement, where relevant

282C.—(1) No person shall make an offer of units or derivatives of units in a business trust unless—

- (a) the business trust is a registered business trust; and
- (b) the offer—
 - (i) is made in or accompanied by a prospectus in respect of the offer—
 - (A) that is prepared in accordance with section 282F;
 - (B) a copy of which, being one that has been signed in accordance with subsection (5), is lodged with the Authority; and
 - (C) that is registered by the Authority; and
 - (ii) complies with such requirements as may be prescribed by the Authority.

[1/2005]

(2) A person who lodges a preliminary document with the Authority shall be deemed to have lodged a prospectus with the Authority.

[1/2005]

(3) A preliminary document referred to in subsection (2) shall contain all information to be included in a prospectus other than such information as may be prescribed by the Authority.

[1/2005]

(4) Notwithstanding subsection (1), an offer of units or derivatives of units in a business trust may be made in or accompanied by an extract from, or an abridged version of, a prospectus (referred to in this section as a profile statement), instead of a prospectus, if—

- (a) a prospectus in respect of such offer is prepared in accordance with section 282F, and the profile statement is prepared in accordance with section 282G;
- (b) a copy of the prospectus and a copy of the profile statement, each of which has been signed in accordance with subsection (5), are lodged with the Authority, and the prospectus is lodged no later than the profile statement;
- (c) the prospectus and profile statement are registered by the Authority;
- (d) sufficient copies of the prospectus are made available for collection at the times and places specified in the profile statement; and
- (e) the offer complies with such requirements as may be prescribed by the Authority.

[1/2005]

(5) The copy of a prospectus or profile statement lodged with the Authority shall be signed—

- (a) where the person making the offer is the issuer, by every director or equivalent person of the issuer and every person who is named therein as a proposed director or an equivalent person of the issuer;
- (b) where the person making the offer is an individual and is not the issuer—
 - (i) by that person; and
 - (ii) if the issuer is controlled by that person, one or more of his related parties, or that person and one or more of his related parties, by every director or equivalent person of the issuer and every person who is named therein as a proposed director or an equivalent person of the issuer; and
- (c) where the person making the offer is an entity and is not the issuer—
 - (i) by every director or equivalent person of that entity; and
 - (ii) if the issuer is controlled by that entity, one or more of its related parties, or that entity and one or more of its related parties, by every director or

continued on next page

Box A1.1 continuation

equivalent person of the issuer, and every person who is named therein as a proposed director or an equivalent person of the issuer.

[1/2005]

(6) A requirement under subsection (5) for the copy of a prospectus or profile statement to be signed by a director or an equivalent person is satisfied if the copy is signed—

- (a) by that director or equivalent person; or
- (b) by a person who is authorised in writing by that director or equivalent person to sign on his behalf.

[1/2005]

(7) A requirement under subsection (5) for the copy of a prospectus or profile statement to be signed by a person named therein as a proposed director or an equivalent person is satisfied if the copy is signed—

- (a) by that proposed director or equivalent person; or
- (b) by a person who is authorised in writing by that proposed director or equivalent person to sign on his behalf.

[1/2005]

(8) No person shall make any offer of units or derivatives of units in a business trust that has not been formed or does not exist.

[1/2005]

(9) Any person who contravenes subsection (1) or (8) shall be guilty of an offence and shall be liable on conviction to a fine not exceeding \$150,000 or to imprisonment for a term not exceeding 2 years or to both and, in the case of a continuing offence, to a further fine not exceeding \$15,000 for every day or part thereof during which the offence continues after conviction.

[1/2005]

(10) The Authority may register a prospectus or profile statement on any day within the period prescribed by the Authority from the date of lodgment thereof with the Authority, unless—

- (a) the Authority gives to the person making the offer a notice of an opportunity to be heard under subsection (20);
- (b) the Authority gives to the person making the offer notice of an extension, in which case the Authority may, not later than 28 days from the date of lodgment of the prospectus or profile statement—
 - (i) register the prospectus or profile statement; or
 - (ii) give the person making the offer a notice of an opportunity to be heard under subsection (20);
- (c) the person making the offer applies in writing to extend the period during which the prospectus or profile statement may be registered, and the Authority grants an extension as it thinks fit, in which case the Authority may, at any time up to and including the date on which the extended period ends—
 - (i) register the prospectus or profile statement; or
 - (ii) give the person making the offer a notice of an opportunity to be heard under subsection (20); or
- (d) the person making the offer gives a notice in writing to the Authority to withdraw the lodgment of the prospectus or profile statement, in which case the Authority shall not register the prospectus or profile statement.

[1/2005]

(11) Where, after a notice of an opportunity to be heard has been given under subsection (10) (a), (b) (ii) or (c) (ii), the Authority decides not to refuse registration of the prospectus or profile statement, the Authority may proceed with the registration on such date as it considers appropriate, except that that date shall not be earlier than such day from the date of lodgment of the prospectus or profile statement with the Authority as the Authority may prescribe.

[1/2005]

(11A) For the purposes of subsections (10) and (11), the Authority may prescribe the same period and day for all offers or different periods and days for different offers.

(12) Where a prospectus lodged with the Authority is a preliminary document, the Authority shall not register the prospectus unless a copy of the prospectus which has been signed in accordance with subsection (5) and which contains the information required to be stipulated in the prospectus under section 282F, including such information which could be omitted from the preliminary document by virtue of subsection (3), has been lodged with the Authority.

[1/2005]

(13) A person making an offer of units or derivatives of units in a business trust may lodge any amendment to a prospectus or profile statement in respect of that offer at any time before but not after the registration of the prospectus or profile statement by the Authority.

[1/2005]

(14) Subject to subsection (15)—

- (a) where any amendment to a prospectus is lodged, the prospectus and any profile statement which is lodged shall be deemed, for the purposes of subsection (10), to have been lodged when such amendment was lodged; and
- (b) where any amendment to a profile statement is lodged, the profile statement shall be deemed, for the purposes of subsection (10), to have been lodged when such amendment was lodged.

[1/2005]

(15) Where an amendment to a prospectus or profile statement is lodged with the consent of the Authority, the prospectus or profile statement as amended shall be deemed, for the purposes of subsection (10), to have been lodged when the original prospectus or profile statement was lodged with the Authority.

[1/2005]

(16) An amendment to a prospectus or profile statement that is lodged shall be treated as part of the original prospectus or profile statement.

[1/2005]

(17) The Authority may, for public information, publish—

continued on next page

Box A1.1 continuation

(a) a prospectus or profile statement lodged with the Authority under this section; and
 (b) where applicable, the translation thereof in the English language lodged with the Authority under section 318A (1), and, for the purposes of this subsection, the person making the offer shall provide the Authority with a copy of the prospectus or profile statement and, where applicable, the translation, in such form or medium for publication as the Authority may require.

[1/2005]

(18) The Authority shall refuse to register a prospectus if—

- (a) the Authority is of the opinion that the prospectus contains a false or misleading statement;
- (b) there is an omission from the prospectus of any information that is required to be included in it under section 282F;
- (c) the copy of the prospectus that is lodged with the Authority is not signed in accordance with subsection (5);
- (d) the Authority is of the opinion that the prospectus does not comply with the requirements of this Act;
- (e) any written consent of an expert to the issue of the prospectus required under section 282I, or a copy thereof which is verified as prescribed, is not lodged with the Authority;
- (f) any written consent of an issue manager to the issue of the prospectus required under section 282J (1), or a copy thereof which is verified as prescribed, is not lodged with the Authority;
- (g) any written consent of an underwriter to the issue of the prospectus required under section 282J (2), or a copy thereof which is verified as prescribed, is not lodged with the Authority; or
- (h) the Authority is of the opinion that it is not in the public interest to do so.

[1/2005]

(19) The Authority shall refuse to register a profile statement if—

- (a) the Authority is of the opinion that the profile statement contains a false or misleading statement;
- (b) there is an omission from the profile statement of information required under section 282G to be included in it or an inclusion in the profile statement of information prohibited by that section from being included in it;
- (c) the copy of the profile statement that is lodged with the Authority is not signed in accordance with subsection (5);
- (d) any written consent of an expert to the issue of the profile statement required under section 282I, or a copy thereof which is verified as prescribed, is not lodged with the Authority;
- (e) the Authority is of the opinion that the profile statement does not comply with the requirements of this Act;
- (f) the prospectus has not been registered by the Authority;
- (g) any written consent of an issue manager to the issue of the profile statement required under section 282J (1), or a copy thereof which is verified as prescribed, is not lodged with the Authority;
- (h) any written consent of an underwriter to the issue of the profile statement required under section 282J (2), or a copy thereof which is verified as prescribed, is not lodged with the Authority; or
- (i) the Authority is of the opinion that it is not in the public interest to do so.

[1/2005]

(20) The Authority shall not refuse to register a prospectus under subsection (18) or a profile statement under subsection (19) without giving the person making the offer an opportunity to be heard, except that an opportunity to be heard need not be given if the refusal is on the ground that it is not in the public interest to register the prospectus or profile statement on the basis of any of the following circumstances:

- (a) the person making the offer (being an entity), the issuer, the trustee-manager of the business trust or the business trust itself is in the course of being wound up or otherwise dissolved, whether in Singapore or elsewhere;
- (b) the person making the offer (being an individual) is an undischarged bankrupt, whether in Singapore or elsewhere; or
- (c) a receiver, a receiver and manager or an equivalent person has been appointed, whether in Singapore or elsewhere, in relation to or in respect of any property of the person making the offer (being an entity), the issuer or the trustee-manager of the business trust, or in relation to or in respect of the trust property of the business trust.

[1/2005]

(21) Any person making an offer may, within 30 days after he is notified that the Authority has refused to register a prospectus or profile statement to which his offer relates under subsection (18) or (19), appeal to the Minister whose decision shall be final.

[1/2005]

(22) If—

- (a) a prospectus or profile statement is issued, circulated or distributed before it has been registered by the Authority; or
 - (b) an application to subscribe for or purchase units or derivatives of units in a business trust is accepted, or units or derivatives of units in a business trust are allotted, issued or sold, before a prospectus and, where applicable, profile statement, where applicable, in respect of the units or derivatives of units has been registered by the Authority,
- the person making the offer and every person who is knowingly a party to—
- (i) the issue, circulation or distribution of the prospectus or profile statement;
 - (ii) the acceptance of the application to subscribe for or purchase the units or derivatives of units; or
 - (iii) the allotment, issue or sale of the units or derivatives of units,
- as the case may be, shall be guilty of an offence and shall be liable on conviction to a fine not exceeding \$150,000 or to imprisonment for a term not exceeding 2 years or to both and, in the case of a continuing offence, to a further fine not exceeding \$15,000 for every day or part thereof during which the offence continues after conviction.

[1/2005]

(23) Regulations made under this section may provide that a contravention of specified provisions thereof shall be an offence and may provide for penalties not exceeding a fine of \$50,000.

continued on next page

Box A1.1 continuation

(24) For the purposes of subsections (18) (a) and (19) (a), any reference to a statement shall include a reference to any information presented, regardless of whether such information is in text or otherwise. [1/2005]

[SFA, s. 240] [1/2005]

Lodging supplementary document or replacement document

282D.—(1) If, after a prospectus or profile statement is registered but before the close of the offer of units or derivatives of units in a business trust, the person making that offer becomes aware of—

- (a) a false or misleading statement in the prospectus or profile statement;
 - (b) an omission from the prospectus of any information that should have been included in it under section 282F, or an omission from the profile statement of any information that should have been included in it under section 282G, as the case may be; or
 - (c) a new circumstance that—
 - (i) has arisen since the prospectus or profile statement was lodged with the Authority; and
 - (ii) would have been required by—
 - (A) section 282F to be included in the prospectus; or
 - (B) section 282G to be included in the profile statement,
- if it had arisen before the prospectus or the profile statement, as the case may be, was lodged, and that is materially adverse from the point of view of an investor, the person may lodge a supplementary or replacement prospectus, or a supplementary or replacement profile statement (referred to in this section as a supplementary or replacement document, as the case may be), with the Authority. [1/2005]

(2) At the beginning of a supplementary document, there shall be—

- (a) a statement that it is a supplementary prospectus or a supplementary profile statement, as the case may be;
- (b) an identification of the prospectus or profile statement it supplements;
- (c) an identification of any previous supplementary document lodged with the Authority in relation to the offer; and
- (d) a statement that it is to be read together with the prospectus or profile statement it supplements and any previous supplementary document in relation to the offer. [1/2005]

(3) At the beginning of a replacement document, there shall be—

- (a) a statement that it is a replacement prospectus or a replacement profile statement, as the case may be; and
- (b) an identification of the prospectus or profile statement it replaces. [1/2005]

(4) The supplementary document and the replacement document must be dated with the date on which they are lodged with the Authority. [1/2005]

(5) The person making the offer shall take reasonable steps—

- (a) to inform potential investors of the lodgment of any supplementary or replacement document under subsection (1); and
- (b) to make available to them the supplementary document or replacement document. [1/2005]

(6) For the purposes of the application of this Division to events that occur after the lodgment of the supplementary document—

- (a) where the supplementary document is a supplementary prospectus, the prospectus in relation to the offer shall be taken to be the original prospectus together with the supplementary prospectus and any previous supplementary prospectus in relation to the offer; and
- (b) where the supplementary document is a supplementary profile statement, the profile statement in relation to the offer shall be taken to be the original profile statement together with the supplementary profile statement and any previous supplementary profile statement in relation to the offer. [1/2005]

(7) For the purposes of the application of this Division to events that occur after the lodgment of the replacement document—

- (a) where the replacement document is a replacement prospectus, the prospectus in relation to the offer shall be taken to be the replacement prospectus; and
- (b) where the replacement document is a replacement profile statement, the profile statement in relation to the offer shall be taken to be the replacement profile statement. [1/2005]

(8) If a supplementary document or replacement document is lodged with the Authority, the offer shall be kept open for at least 14 days after the lodgment of the supplementary document or replacement document. [1/2005]

(9) Where, prior to the lodgment of the supplementary document or replacement document, applications have been made under the original prospectus or profile statement to subscribe for units or derivatives of units in a business trust, then—

- (a) where the units or derivatives of units have not been issued to the applicants, the person making the offer—
 - (i) shall—
 - (A) within 2 days (excluding any Saturday, Sunday or public holiday) from the date of lodgment of the supplementary document or replacement document, give the applicants notice in writing of how to obtain, or arrange to receive, a copy of the supplementary document or replacement document, as the case may be, and provide the applicants with an option to withdraw their applications; and

continued on next page

Box A1.1 continuation

(B) take all reasonable steps to make available within a reasonable period the supplementary document or replacement document, as the case may be, to the applicants who have indicated that they wish to obtain, or who have arranged to receive, a copy of the supplementary document or replacement document;

(ii) shall, within 7 days from the date of lodgment of the supplementary document or replacement document, give the applicants the supplementary document or replacement document, as the case may be, and provide the applicants with an option to withdraw their applications; or

(iii) shall—

(A) treat the applications as withdrawn and cancelled, in which case the applications shall be deemed to have been withdrawn and cancelled; and

(B) within 7 days from the date of lodgment of the supplementary document or replacement document, pay to the applicants all moneys the applicants have paid on account of their applications for the units or derivatives of units in the business trust; or

(b) where the units or derivatives of units have been issued to the applicants, the person making the offer—

(i) shall—

(A) within 2 days (excluding any Saturday, Sunday or public holiday) from the date of lodgment of the supplementary document or replacement document, give the applicants notice in writing of how to obtain, or arrange to receive, a copy of the supplementary document or replacement document, as the case may be, and provide the applicants with an option to return, to the person making the offer, those units or derivatives of units in the business trust which they do not wish to retain title in; and

(B) take all reasonable steps to make available within a reasonable period the supplementary document or replacement document, as the case may be, to the applicants who have indicated that they wish to obtain, or who have arranged to receive, a copy of the supplementary document or replacement document;

(ii) shall, within 7 days from the date of lodgment of the supplementary document or replacement document, give the applicants the supplementary document or replacement document, as the case may be, and provide the applicants with an option to return, to the person making the offer, those units or derivatives of units in the business trust which they do not wish to retain title in; or

(iii) shall—

(A) treat the issue of the units or derivatives of units in the business trust as void, in which case the issue shall be deemed void; and

(B) within 7 days from the date of lodgment of the supplementary document or replacement document, pay to the applicants all moneys paid by them for the units or derivatives of units.

[1/2005]

(10) An applicant who wishes to exercise his option under subsection (9) (a) (i) or (ii) to withdraw his application shall, within 14 days from the date of lodgment of the supplementary document or replacement document, notify the person making the offer of this, whereupon that person shall, within 7 days from the receipt of such notification, pay to the applicant all moneys paid by him on account of his application for the units or derivatives of units in the business trust.

[1/2005]

(11) An applicant who wishes to exercise his option under subsection (9) (b) (i) or (ii) to return units or derivatives of units in the business trust issued to him shall, within 14 days from the date of lodgment of the supplementary document or replacement document, notify the person making the offer of this and return all documents, if any, purporting to be evidence of title to those units or derivatives of units to that person, whereupon that person shall, within 7 days from the receipt of such notification and documents, if any, pay to the applicant all moneys paid by the applicant for the units or derivatives of units in the business trust, and the issue of those units or derivatives of units shall be deemed to be void.

[1/2005]

(12) Where, prior to the lodgment of the supplementary document or replacement document, applications have been made under the original prospectus or profile statement to purchase units or derivatives of units in a business trust, then—

(a) where the units or derivatives of units have not been transferred to the applicants, the person making the offer—

(i) shall—

(A) within 2 days (excluding any Saturday, Sunday or public holiday) from the date of lodgment of the supplementary document or replacement document, give the applicants notice in writing of how to obtain, or arrange to receive, a copy of the supplementary document or replacement document, as the case may be, and provide the applicants with an option to withdraw their applications; and

(B) take all reasonable steps to make available within a reasonable period the supplementary document or replacement document, as the case may be, to the applicants who have indicated that they wish to obtain, or who have arranged to receive, a copy of the supplementary document or replacement document;

(ii) shall, within 7 days from the date of lodgment of the supplementary document or replacement document, give the applicants the supplementary document or replacement document, as the case may be, and provide the applicants with an option to withdraw their applications; or

(iii) shall—

(A) treat the applications as withdrawn and cancelled, in which case the applications shall be deemed to have been withdrawn and cancelled; and

(B) within 7 days from the date of lodgment of the supplementary document or replacement document, pay to the applicants all moneys the applicants have paid on account of their applications for the units or derivatives of units in the business trust; or

(b) where the units or derivatives of units have been transferred to the applicants, the person making the offer—

(i) shall—

(A) within 2 days (excluding any Saturday, Sunday or public holiday) from the date of lodgment of the supplementary document or replacement document, give the applicants notice in writing of how to obtain, or arrange to receive, a copy of the supplementary document or replacement document, as the case may be, and provide the applicants with an option to return, to the person making the offer, those units or derivatives of units in the business trust which they do not wish to retain title in; and

(B) take all reasonable steps to make available within a reasonable period the supplementary document or replacement document, as the case may be, to the applicants who have indicated that they wish to obtain, or who have arranged to receive, a copy of the supplementary document or replacement

continued on next page

Box A1.1 continuation

document;

(ii) shall, within 7 days from the date of lodgment of the supplementary document or replacement document, give the applicants the supplementary document or replacement document, as the case may be, and provide the applicants with an option to return, to the person making the offer, those units or derivatives of units in the business trust which they do not wish to retain title in; or

(iii) shall treat the sale of the units or derivatives of units in the business trust as void, in which case the sale shall be deemed void, and shall—

(A) if documents purporting to evidence title to the units or derivatives of units (referred to in this paragraph as the title documents) have been issued to the applicants—

(AA) within 7 days from the date of lodgment of the supplementary document or replacement document, inform the applicants to return the title documents to the person making the offer within 14 days from the date of lodgment of the supplementary document or replacement document; and

(AB) within 7 days from the date of the receipt of the title documents or the date of lodgment of the supplementary document or replacement document, whichever is the later, pay to the applicants all moneys paid by them for the units or derivatives of units; or

(B) if no title documents have been issued to the applicants, within 7 days from the date of the lodgment of the supplementary document or replacement document, pay to the applicants all moneys paid by them for the units or derivatives of units.

[1/2005]

(13) An applicant who wishes to exercise his option under subsection (12) (a) (i) or (ii) to withdraw his application shall, within 14 days from the date of lodgment of the supplementary document or replacement document, notify the person making the offer of this, whereupon that person shall, within 7 days of the receipt of such notification, pay to him all moneys paid by him on account of his application for the units or derivatives of units in the business trust.

[1/2005]

(14) An applicant who wishes to exercise his option under subsection (12) (b) (i) or (ii) to return units or derivatives of units in the business trust sold to him shall, within 14 days from the date of lodgment of the supplementary document or replacement document, notify the person making the offer of this and return all documents, if any, purporting to evidence title to those units or derivatives of units to the person making the offer, whereupon that person shall, within 7 days from the receipt of such notification and documents, if any, pay to the applicant all moneys paid by him for the units or derivatives of units and the sale of those units or derivatives of units shall be deemed to be void.

[1/2005]

(15) Any person who contravenes subsection (9) or (12) shall be guilty of an offence and shall be liable on conviction to a fine not exceeding \$100,000 and, in the case of a continuing offence, to a further fine not exceeding \$10,000 for every day or part thereof during which the offence continues after conviction.

[1/2005]

(16) Any person who contravenes any other provision of this section shall be guilty of an offence and shall be liable on conviction to a fine not exceeding \$50,000 and, in the case of a continuing offence, to a further fine not exceeding \$5,000 for every day or part thereof during which the offence continues after conviction.

[1/2005]

(17) For the purposes of subsection (1) (a), the reference to a statement shall include a reference to any information presented, regardless of whether such information is in text or otherwise.

[1/2005]

[SFA, s. 241]

Stop order for prospectus and profile statement

282E.—(1) If a prospectus has been registered and—

(a) the Authority is of the opinion that the prospectus contains a false or misleading statement;

(b) there is an omission from the prospectus of any information that is required to be included in it under section 282F;

(c) the Authority is of the opinion that the prospectus does not comply with the requirements of this Act; or

(d) the Authority is of the opinion that it is in the public interest to do so,

the Authority may, by an order in writing (referred to in this section as a stop order) served on the person making the offer of units or derivatives of units in a business trust to which the prospectus relates, direct that no or no further units or derivatives of units in the business trust be allotted, issued or sold.

[1/2005]

(2) If a profile statement has been registered and—

(a) the Authority is of the opinion that the profile statement contains a false or misleading statement;

(b) there is an omission from the profile statement of any information that is required to be included in it under section 282G;

(c) the Authority is of the opinion that the profile statement does not comply with the requirements of this Act; or

(d) the Authority is of the opinion that it is in the public interest to do so,

the Authority may, by an order in writing (referred to in this section as a stop order) served on the person making the offer of the units or derivatives of units in a business trust to which the profile statement relates, direct that no or no further units or derivatives of units in the business trust allotted, issued or sold.

[1/2005]

(3) Notwithstanding subsections (1) and (2), the Authority shall not serve a stop order if any of the units or derivatives of units in a business trust to which the prospectus or profile statement relates has been issued or sold, and listed for quotation on a securities exchange and trading in them has commenced.

[1/2005]

continued on next page

Box A1.1 continuation

(4) The Authority shall not serve a stop order under subsection (1) or (2) without giving the person making the offer an opportunity to be heard, except that an opportunity to be heard need not be given if the stop order is served on the ground that it is in the public interest to do so on the basis of any of the following circumstances:

- (a) the person making the offer (being an entity), the issuer, the trustee-manager of the business trust or the business trust itself is in the course of being wound up or otherwise dissolved, whether in Singapore or elsewhere;
- (b) the person making the offer (being an individual) is an undischarged bankrupt, whether in Singapore or elsewhere;
- (c) a receiver, a receiver and manager or an equivalent person has been appointed, whether in Singapore or elsewhere, in relation to or in respect of any property of the person making the offer (being an entity), the issuer, the trustee-manager of the business trust or, in relation to or in respect of the trust property of the business trust.

[1/2005]

(5) Where applications to subscribe for units or derivatives of units in a business trust to which the prospectus or profile statement relates have been made prior to the stop order, then—

- (a) where the units or derivatives of units have not been issued to the applicants—
 - (i) the applications shall be deemed to have been withdrawn and cancelled; and
 - (ii) the person making the offer shall, within 14 days from the date of the stop order, pay to the applicants all moneys the applicants have paid on account of their applications for the units or derivatives of units; or
- (b) where the units or derivatives of units have been issued to the applicants—
 - (i) the issue of the units or derivatives of units shall be deemed to be void; and
 - (ii) the person making the offer shall, within 14 days from the date of the stop order, pay to the applicants all moneys paid by them for the units or derivatives of units.

[1/2005]

(6) Where applications to purchase units or derivatives of units in a business trust to which the prospectus or profile statement relates have been made prior to the stop order, then—

- (a) where the units or derivatives of units have not been transferred to the applicants—
 - (i) the applications shall be deemed to have been withdrawn and cancelled; and
 - (ii) the person making the offer shall, within 14 days from the date of the stop order, pay to the applicants all moneys the applicants have paid on account of their applications for the units or derivatives of units; or
- (b) where the units or derivatives of units have been transferred to the applicants, the sale shall be deemed to be void, and the person making the offer shall—
 - (i) if documents purporting to evidence title to the units or derivatives of units have been issued to the applicants—
 - (A) within 7 days from the date of the stop order, inform the applicants to return such documents to the person making the offer within 14 days from that date; and
 - (B) within 7 days from the date of the receipt of those documents or the date of the stop order, whichever is the later, pay to the applicants all moneys paid by them for the units or derivatives of units; or
 - (ii) if no such documents have been issued to the applicants, within 7 days from the date of the stop order, pay to the applicants all moneys paid by them for the units or derivatives of units.

[1/2005]

(7) If the Authority is of the opinion that any delay in serving a stop order pending the holding of a hearing required under subsection (4) is not in the interests of the public, the Authority may, without giving an opportunity to be heard, serve an interim stop order on the person making the offer directing that no or no further units or derivatives of units in a business trust to which the prospectus or profile statement relates be allotted, issued or sold.

[1/2005]

(8) An interim stop order shall, unless revoked by the Authority, be in force—

- (a) in a case where—
 - (i) it is served during a hearing under subsection (4); or
 - (ii) a hearing under subsection (4) is commenced while it is in force, until the Authority makes an order under subsection (1) or (2); and
- (b) in any other case, for a period of 14 days from the day on which the interim stop order is served.

[1/2005]

(9) Subsections (5) and (6) shall not apply where only an interim stop order has been served.

[1/2005]

(10) Any person who fails to comply with a stop order served under subsection (1) or (2) or an interim stop order served under subsection (7) shall be guilty of an offence and shall be liable on conviction to a fine not exceeding \$150,000 or to imprisonment for a term not exceeding 2 years or to both and, in the case of a continuing offence, to a further fine not exceeding \$15,000 for every day or part thereof during which the offence continues after conviction.

[1/2005]

(11) Any person who contravenes subsection (5) or (6) shall be guilty of an offence and shall be liable on conviction to a fine not exceeding \$100,000 and, in the case of a continuing offence, to a further fine not exceeding \$10,000 for every day or part thereof during which the offence continues after conviction.

[1/2005]

(12) For the purposes of subsections (1) (a) and (2) (a), any reference to a statement shall include a reference to any information presented, regardless

continued on next page

Box A1.1 continuation

of whether such information is in text or otherwise.

[1/2005]

[SFA, s. 242]

Contents of prospectus

282F.—(1) A prospectus for an offer of units or derivatives of units in a business trust shall contain—

- (a) all the information that investors and their professional advisers would reasonably require to make an informed assessment of the matters specified in subsection (3); and
- (b) the matters prescribed by the Authority.

[1/2005]

(2) The prospectus shall, with respect to subsection (1) (a), contain such information—

- (a) only to the extent to which it is reasonable for investors and their professional advisers to expect to find in the prospectus; and
- (b) only to the extent that a person whose knowledge is relevant—
 - (i) actually knows the information; or
 - (ii) in the circumstances ought reasonably to have obtained the information by making enquiries.

[1/2005]

(3) The matters referred to in subsection (1) (a) shall relate to—

- (a) the rights and liabilities attaching to the units or derivatives of units in the business trust;
- (b) where the person making the offer of units or derivatives of units in the business trust is the trustee-manager of the business trust or the trustee-manager of the business trust is controlled by—
 - (i) the person making the offer;
 - (ii) one or more of the related parties of the person making the offer; or
 - (iii) the person making the offer and one or more of his related parties,
 the assets and liabilities, profits and losses and financial position and performance of the business trust and of the trustee-manager, and the prospects of the business trust;
- (c) where derivatives of units in the business trust are issued by an entity other than the trustee-manager of the business trust and the person making the offer is that entity or that entity is controlled by—
 - (i) the person making the offer;
 - (ii) one or more of the related parties of the person making the offer; or
 - (iii) the person making the offer and one or more of his related parties,
 the assets and liabilities, profits and losses, financial position and performance, and prospects of that entity; and
- (d) in the case of an offer of derivatives of units in the business trust, where the person making the offer, or an entity which is controlled by—
 - (i) the person making the offer;
 - (ii) one or more of the related parties of the person making the offer; or
 - (iii) the person making the offer and one or more of his related parties,
 is or will be required to issue or deliver the relevant units or derivatives of units, or meet financial or contractual obligations to the holders of those derivatives of units, the capacity of that person or entity to issue or deliver the relevant units or derivatives of units in that business trust, or the ability of that person or entity to meet those financial or contractual obligations.

[1/2005]

(4) In deciding what information shall be included under subsection (1) (a), regard shall be had to—

- (a) the nature of the units or derivatives of units in the business trust and the nature of the business trust concerned;
- (b) the matters that likely investors may reasonably be expected to know; and
- (c) the fact that certain matters may reasonably be expected to be known to the professional advisers of such investors.

[1/2005]

(5) For the purposes of subsection (2) (b), a person's knowledge is relevant only if he is one of the following persons:

- (a) the person making the offer;
- (b) if the person making the offer is an entity, a director or equivalent person of the entity;
- (c) the issuer;
- (d) a director or equivalent person, or a proposed director or equivalent person, of the issuer;
- (e) a person named in the prospectus with his consent as an underwriter to the issue or sale;
- (f) a person named in the prospectus as a stockbroker to the issue or sale if he participates in any way in the preparation of the prospectus;
- (g) a person named in the prospectus with his consent as having made a statement—
 - (i) that is included in the prospectus; or
 - (ii) on which a statement made in the prospectus is based;
- (h) a person named in the prospectus with his consent as having performed a particular professional or advisory function.

[1/2005]

(6) A condition requiring or binding an applicant for units or derivatives of units in a business trust to waive compliance with any requirement of this section, or purporting to affect him with notice of any contract, document or matter not specifically referred to in the prospectus, shall be void.

[1/2005]

(7) This section does not affect any liability that a person has under any other law.

[1/2005]

continued on next page

Box A1.1 continuation

(8) In subsection (3) (b), “assets and liabilities, profits and losses, financial position and performance, and prospects”, in relation to a business trust, means—

- (a) the assets and liabilities, profits and losses, financial position and performance of that business trust derived from the accounting records and other records kept by the trustee-manager of that business trust; and
- (b) the business and financial prospects anticipated with respect to the operations of the trustee-manager of the business trust in its capacity as trustee-manager of the business trust.

[1/2005]

[SFA, s. 243]

Contents of profile statement

282G.—(1) A profile statement for an offer of units or derivatives of units in a business trust shall contain—

- (a) the following particulars:
 - (i) identification of the business trust, the trustee-manager of the business trust, the person making the offer and the issuer;
 - (ii) identification of the persons signing the profile statement;
 - (iii) the nature of the units or derivatives of units;
 - (iv) the nature of the risks involved in investing in the units or derivatives of units; and
 - (v) details of all amounts payable in respect of the units or derivatives of units (including any amount by way of fee, commission or charge);
- (b) a statement that copies of the prospectus are available for collection at the times and places specified in the profile statement; and
- (c) a statement that the persons referred to in section 282C (5) who have signed the profile statement are satisfied that the profile statement contains a fair summary of the key information in the prospectus.

[1/2005]

(2) A profile statement shall not contain—

- (a) any statement that is false or misleading in the form and context in which it is included;
- (b) any material information that is not contained in the prospectus; and
- (c) any material information that differs in any material particular from that set out in the prospectus.

[1/2005]

(3) For the purposes of subsection (2) (a), the reference to a statement shall include a reference to any information presented, regardless of whether such information is in text or otherwise.

[1/2005]

[SFA, s. 246]

Exemption from requirements as to form or content of prospectus or profile statement

282H.—(1) The Authority may exempt any person or any prospectus or profile statement from any requirement of this Act relating to the form or content of a prospectus or profile statement, subject to such conditions or restrictions as may be determined by the Authority.

[1/2005]

(2) The Authority shall not grant an exemption under subsection (1) unless it is of the opinion that—

- (a) the cost of complying with the requirement in respect of which exemption has been applied for outweighs the resulting protection to investors; or
- (b) it would not be prejudicial to the public interest if the requirement in respect of which the exemption has been applied for were dispensed with.

[1/2005]

(3) The Authority may exempt any class of persons or any class or description of prospectuses or profile statements, from any requirement of this Act relating to the form or content of a prospectus or profile statement, subject to such conditions or restrictions as may be determined by the Authority.

[1/2005]

(4) Any person who contravenes any of the conditions or restrictions imposed under subsection (1) or (3) shall be guilty of an offence and shall be liable on conviction to a fine not exceeding \$50,000 and, in the case of a continuing offence, to a further fine not exceeding \$5,000 for every day or part thereof during which the offence continues after conviction.

[1/2005]

[SFA, s. 247]

Expert's consent to issue of prospectus or profile statement containing statement by him

282I.—(1) Where an offer of units or derivatives of units in a business trust is made in or accompanied by a prospectus or profile statement which includes a statement purporting to be made by, or based on a statement made by, an expert, the prospectus or profile statement shall not be issued unless—

- (a) the expert has given, and has not before the registration of the prospectus or profile statement, as the case may be, withdrawn his written consent to the issue thereof with the statement included in the form and context in which it is included; and
- (b) there appears in the prospectus or profile statement, as the case may be, a statement that the expert has given and has not withdrawn his consent.

[1/2005]

(2) Every person making the offer shall cause a true copy of every written consent referred to in subsection (1) to be deposited, within 7 days after the registration of the prospectus or profile statement, at the registered office of the issuer in Singapore or, if the issuer has no registered office in Singapore, at the address in Singapore specified in the prospectus for that purpose.

[1/2005]

(3) Every issuer shall keep, and make available for inspection by its members and creditors and persons who have subscribed for or purchased the units

continued on next page

Box A1.1 continuation

or derivatives of units in the business trust to which the prospectus or profile statement relates, without payment of any fee, a true copy of every written consent deposited in accordance with subsection (2) for a period of at least 6 months after the registration of the prospectus or profile statement.

[1/2005]

(4) If any prospectus or profile statement is issued in contravention of subsection (1), the person making the offer and every person who is knowingly a party to the issue thereof shall be guilty of an offence and shall be liable on conviction to a fine not exceeding \$50,000 or to imprisonment for a term not exceeding 12 months or to both and, in the case of a continuing offence, to a further fine not exceeding \$5,000 for every day or part thereof during which the offence continues after conviction.

[1/2005]

(5) The Authority may exempt any person or class of persons, or any prospectus or profile statement or class or description of prospectuses or profile statements, from this section, subject to such conditions or restrictions as may be determined by the Authority.

[1/2005]

(6) Any person who contravenes any of the conditions or restrictions imposed under subsection (5) shall be guilty of an offence and shall be liable on conviction to a fine not exceeding \$50,000 and, in the case of a continuing offence, to a further fine not exceeding \$5,000 for every day or part thereof during which the offence continues after conviction.

[1/2005]

[SFA, s. 249]

Consent of issue manager and underwriter to being named in prospectus or profile statement

282J.—(1) Where an offer of units or derivatives of units in a business trust is made in or accompanied by a prospectus or profile statement in which a person is named as the issue manager to the offer, the prospectus or profile statement shall not be issued unless—

(a) the person has given, and has not before the registration of the prospectus or profile statement, as the case may be, withdrawn his written consent to being named in the prospectus or profile statement as issue manager to that offer; and

(b) there appears in the prospectus or profile statement, as the case may be, a statement that the person has given and has not withdrawn his consent.

[1/2005]

(2) Where an offer of units or derivatives of units in a business trust is made in or accompanied by a prospectus or profile statement in which a person is named as the underwriter (but not a sub-underwriter) to the offer, the prospectus or profile statement shall not be issued unless—

(a) the person has given, and has not before the registration of the prospectus or profile statement, as the case may be, withdrawn his written consent to being named in the prospectus or profile statement as underwriter to that offer; and

(b) there appears in the prospectus or profile statement, as the case may be, a statement that the person has given and has not withdrawn such consent.

[1/2005]

(3) If any prospectus or profile statement is issued in contravention of subsection (1) or (2), the person making the offer and every person who is knowingly a party to the issue thereof shall be guilty of an offence and shall be liable on conviction to a fine not exceeding \$50,000 or to imprisonment for a term not exceeding 12 months or to both and, in the case of a continuing offence, to a further fine not exceeding \$5,000 for every day or part thereof during which the offence continues after conviction.

[1/2005]

(4) Every person making the offer shall cause a true copy of every written consent referred to in subsections (1) and (2) to be deposited, within 7 days after the registration of the prospectus or profile statement, at the registered office of the issuer in Singapore or, if it has no registered office in Singapore, at the address in Singapore specified in the prospectus for that purpose.

[1/2005]

(5) Every issuer shall keep, and make available for inspection by its members and creditors and persons who have subscribed for or purchased the units or derivatives of units in the business trust to which the prospectus or profile statement relates, without payment of any fee, a true copy of every written consent deposited in accordance with subsection (4) for a period of at least 6 months after the registration of the prospectus or profile statement.

[1/2005]

Duration of validity of prospectus and profile statement

282K.—(1) No person shall make an offer of units or derivatives of units in a business trust, or allot, issue or sell any units or derivatives of units in a business trust, on the basis of a prospectus or profile statement after the expiration of a period of 6 months from the date of registration by the Authority of the prospectus in relation to such offer, allotment, issue or sale.

[1/2005]

(2) In a case where an entity makes an offer of units or derivatives of units in a business trust or where the units or derivatives of units in a business trust being offered are those issued by an entity or a proposed entity, no officer or equivalent person or promoter of the entity or proposed entity shall authorise or permit—

(a) the offer of those units or derivatives of units; or

(b) the allotment, issue or sale of those units or derivatives of units,

on the basis of a prospectus or profile statement after the expiration of a period of 6 months from the date of registration by the Authority of the prospectus in relation to such offer, allotment, issue or sale.

[1/2005]

(3) If default is made in complying with subsection (1) or (2), the person and, in the case of an entity or proposed entity, every officer or equivalent person or promoter of the entity or proposed entity shall be guilty of an offence and shall be liable on conviction to a fine not exceeding \$50,000 or to imprisonment for a term not exceeding 12 months or to both and, in the case of a continuing offence, to a further fine not exceeding \$5,000 for every day or part thereof during which the offence continues after conviction.

[1/2005]

continued on next page

Box A1.1 continuation

(4) An allotment, an issue or a sale of units or derivatives of units in a business trust that is made in contravention of subsection (1) or (2) shall not, by reason only of that fact, be voidable or void.

[1/2005]

[SFA, s. 250]

Restrictions on advertisements, etc.

282L.—(1) If a prospectus is required for an offer or intended offer of units or derivatives of units in a business trust, a person shall not—

- (a) advertise the offer or intended offer; or
- (b) publish a statement that—
 - (i) directly or indirectly refers to the offer or intended offer; or
 - (ii) is reasonably likely to induce persons to subscribe for or purchase the units or derivatives of units, unless the advertisement or publication is authorised by this section.

[1/2005]

(2) In determining whether a statement—

- (a) indirectly refers to an offer or intended offer of units or derivatives of units in a business trust; or
- (b) is reasonably likely to induce persons to subscribe for or purchase units or derivatives of units in a business trust, regard shall be had to whether the statement—
 - (i) forms part of—
 - (A) the normal advertising by a trustee-manager of a business trust on behalf of the business trust in respect of the products or services offered by the trustee-manager on behalf of the business trust, and is genuinely directed at maintaining existing customers, or attracting new customers, for those products or services; or
 - (B) the normal advertising of an entity's products or services, and is genuinely directed at maintaining its existing customers, or attracting new customers, for those products or services;
 - (ii) communicates information that materially deals with the affairs of the business trust or the entity; and
 - (iii) is likely to encourage investment decisions being made on the basis of the statement rather than on the basis of information contained in a prospectus or profile statement.

[1/2005]

(3) Notwithstanding subsection (6), a person may, before a prospectus or profile statement is registered by the Authority, disseminate a preliminary document which has been lodged with the Authority to institutional investors, relevant persons as defined in section 282Z (3) or persons to whom an offer referred to in section 282Z (2) is to be made without contravening subsection (1), if—

- (a) the front page of the preliminary document contains—
 - (i) the following statement:

“This is a preliminary document and is subject to further amendments and completion in the prospectus to be registered by the Monetary Authority of Singapore.”;
 - (ii) a statement that a person to whom a copy of the preliminary document has been issued shall not circulate it to any other person; and
 - (iii) a statement in bold lettering that no offer or agreement shall be made on the basis of the preliminary document to purchase or subscribe for any units or derivatives of units in the business trust to which the preliminary document relates;
- (b) the preliminary document does not contain or have attached to it any form of application that will facilitate the making by any person of an offer of the units or derivatives of units in the business trust to which the preliminary document relates, or the acceptance of such an offer by any person; and
- (c) when the prospectus is registered by the Authority, the person takes reasonable steps to notify the persons to whom the preliminary document was issued that the registered prospectus is available for collection.

[1/2005]

(4) Notwithstanding subsection (6), a person does not contravene subsection (1) by presenting oral or written material, on matters contained in a preliminary document which has been lodged with the Authority, to institutional investors, relevant persons as defined in section 282Z (3) or persons to whom an offer referred to in section 282Z (2) is to be made before a prospectus or profile statement is registered by the Authority.

[1/2005]

(5) For the avoidance of doubt, a person may disseminate a prospectus or profile statement that has been registered by the Authority under section 282C without contravening subsection (1).

[1/2005]

(6) Before a prospectus or profile statement is registered, an advertisement or a publication does not contravene subsection (1) if it contains only the following:

- (a) a statement that identifies the units or derivatives of units in the business trust, the person making the offer, the issuer, the business trust and the trustee-manager of the business trust;
- (b) a statement that a prospectus or profile statement for the offer will be made available when the offer is made;
- (c) a statement that anyone wishing to acquire the units or derivatives of units in the business trust will need to make an application in the manner set out in the prospectus or profile statement; and
- (d) a statement of how to obtain, or arrange to receive, a copy of the prospectus or profile statement.

[1/2005]

(7) To satisfy subsection (6), the advertisement or publication shall include all of the statements referred to in paragraphs (a), (b) and (c) of that subsection, and may include the statement referred to in paragraph (d).

[1/2005]

continued on next page

Box A1.1 continuation

(8) After a prospectus or profile statement is registered with the Authority, an advertisement or a publication does not contravene subsection (1) if—

- (a) it includes a statement that the prospectus or profile statement in respect of the offer of units or derivatives of units in the business trust is available for collection at the times and places specified in the statement;
- (b) it includes a statement that anyone wishing to acquire the units or derivatives of units in the business trust will need to make an application in the manner set out in the prospectus or profile statement; and
- (c) it does not contain any information that is not included in the prospectus or profile statement.

[1/2005]

(9) An advertisement or a publication does not contravene subsection (1) if it—

- (a) consists solely of a disclosure, notice or report required under this Act, or any listing rules or other requirements of a securities exchange, futures exchange or overseas securities exchange made by any person;
- (b) consists solely of a notice or report of a general meeting or proposed general meeting of the person making the offer, the issuer, the trustee-manager of the business trust or any entity, a notice or report of a general meeting or proposed general meeting of the unit holders of the business trust, or a presentation of oral or written material on matters so contained in the notice or report at the general meeting;
- (c) consists solely of a report about the issuer or the business trust whose units or derivatives of units are the subject of the offer or intended offer that is published by the person making the offer, the issuer or the trustee-manager of the business trust, which—
 - (i) does not contain information that materially affects the affairs of the issuer or the business trust other than information previously made available in a prospectus that has been registered by the Authority, an annual report or a disclosure, notice or report referred to in paragraph (a) or (b); and
 - (ii) does not refer (directly or indirectly) to the offer or intended offer;
- (d) consists solely of a statement made by the person making the offer, the issuer or the trustee-manager of the business trust that a prospectus or profile statement in respect of the offer or intended offer has been lodged with the Authority;
- (e) is a news report, or a genuine comment, by a person other than any person referred to in paragraph (f) (i), (ii), (iii) or (iv), in a newspaper, periodical or magazine or on radio, television or any other means of broadcasting or communication, relating to—
 - (i) a prospectus or profile statement that has been lodged with the Authority or information contained in such a prospectus or profile statement;
 - (ii) a disclosure, notice or report referred to in paragraph (a);
 - (iii) a notice, report, presentation, general meeting or proposed general meeting referred to in paragraph (b);
 - (iv) a report referred to in paragraph (c);
- (f) is a report about the units or derivatives of units in a business trust which are the subject of the offer or intended offer, published by someone who is not—
 - (i) the person making the offer, the issuer or the trustee-manager of the business trust;
 - (ii) a director or equivalent person of the person making the offer, the issuer or the trustee-manager of the business trust;
 - (iii) a person who has an interest in the success of the issue or sale of the units or derivatives of units in the business trust; or
 - (iv) a person acting at the instigation of, or by arrangement with, any person referred to in sub-paragraph (i), (ii) or (iii);
- (g) is a report about the units or derivatives of units in a business trust which are the subject of the offer or intended offer, published and delivered to any institutional investor not later than 14 days prior to the date of lodgment of the prospectus, provided that—
 - (i) the offer is also made or will also be made in one or more other countries;
 - (ii) the publication and delivery of such report in that other country or any one of those other countries do not infringe any law, code or other requirement of that country;
 - (iii) the report and the manner of its publication and delivery in Singapore comply with such other requirements as may be prescribed by the Authority; and
 - (iv) the person issuing the report complies with such requirements as may be prescribed by the Authority; or
- (h) is a publication made by the person making the offer, the issuer or the trustee-manager of the business trust solely to correct or provide clarification on any erroneous or inaccurate information or comment contained in—
 - (i) an earlier news report or a genuine comment referred to in paragraph (e); or
 - (ii) an earlier publication published in the ordinary course of business of publishing a newspaper, periodical or magazine, or of broadcasting by radio, television or any other means of broadcasting or communication, referred to in subsection (10),
 provided that the first-mentioned publication does not contain any material information that is not included in the prospectus.

[1/2005]

(10) A person does not contravene subsection (1) if—

- (a) he publishes any advertisement or publication in the ordinary course of a business of—
 - (i) publishing a newspaper, periodical or magazine; or
 - (ii) broadcasting by radio, television or any other means of broadcasting or communication; and
- (b) he did not know and had no reason to suspect that its publication would constitute a contravention of subsection (1).

[1/2005]

(11) Subsection (9) (e) and (f) shall not apply to an advertisement or a statement if any person gives consideration or any other benefit for the publication of the advertisement or statement.

[1/2005]

(12) Any person who contravenes subsection (1) or who knowingly authorised or permitted the publication or dissemination in contravention of subsection (1) shall be guilty of an offence and shall be liable on conviction to a fine not exceeding \$50,000 or to imprisonment for a term not exceeding 12 months or to both and, in the case of a continuing offence, to a further fine not exceeding \$5,000 for every day or part thereof during which the offence continues after conviction.

[1/2005]

(13) This section does not affect any liability that a person has under any other law.

continued on next page

Box A1.1 continuation

(14) The Authority may exempt any person or class of persons from this section, subject to such conditions or restrictions as may be determined by the Authority. [1/2005]

(15) Any person who contravenes any of the conditions or restrictions imposed under subsection (14) shall be guilty of an offence and shall be liable on conviction to a fine not exceeding \$50,000 and, in the case of a continuing offence, to a further fine not exceeding \$5,000 for every day or part thereof during which the offence continues after conviction. [1/2005]

(16) For the purposes of this section, any reference to publishing a statement shall be construed as including a reference to making a statement, whether oral or written, which is reasonably likely to be published. [1/2005]

(17) For the purposes of subsections (1) and (2), any reference to a statement shall include a reference to any information presented, regardless of whether such information is in text or otherwise. [1/2005]

(18) For the purposes of subsection (2) (ii), the reference to affairs of the business trust or the entity shall—
 (a) in the case of the business trust, be construed to refer to such matters as may be prescribed by the Authority;
 (b) in the case where the entity is a corporation, be construed as including a reference to the matters referred to in section 2 (2); and
 (c) in the case where the entity is not a corporation, be construed to refer to such matters as may be prescribed by the Authority. [1/2005]

(19) For the purposes of subsection (9) (c) (i), the reference to affairs of the issuer or the business trust shall—
 (a) in the case where the issuer is a corporation, be construed as including a reference to the matters referred to in section 2 (2);
 (b) in the case where the issuer is not a corporation, be construed to refer to such matters as may be prescribed by the Authority; and
 (c) in the case of the business trust, be construed to refer to such matters as may be prescribed by the Authority. [1/2005]

[SFA, s. 251] [1/2005]

Persons liable on prospectus or profile statement to inform person making offer about certain deficiencies

282M.—(1) A person referred to in section 2820 (3) (other than paragraph (a)) shall notify in writing the person making the offer of units or derivatives of units in a business trust, as soon as practicable, if he becomes aware at any time after the prospectus or profile statement is registered by the Authority but before the close of the offer that—
 (a) a statement in the prospectus or the profile statement is false or misleading;
 (b) there is an omission to state any information required to be included in the prospectus under section 282F or there is an omission to state any information required to be included in the profile statement under section 282G, as the case may be; or
 (c) a new circumstance—
 (i) has arisen since the prospectus or the profile statement was lodged with the Authority; and
 (ii) would have been required to be included in the prospectus under section 282F, or required to be included in the profile statement under section 282G, as the case may be, if it had arisen before the prospectus or the profile statement was lodged with the Authority, and the failure to so notify would have been materially adverse from the point of view of an investor. [1/2005]

(2) Any person who contravenes subsection (1) shall be guilty of an offence and shall be liable on conviction to a fine not exceeding \$50,000. [1/2005]

(3) For the purposes of subsection (1) (a), any reference to a statement shall include a reference to any information presented, regardless of whether such information is in text or otherwise. [1/2005]

[SFA, s. 252]

Criminal liability for false or misleading statements

282N.—(1) Where an offer of units or derivatives of units in a business trust is made in or accompanied by a prospectus or profile statement, or, in the case of an offer referred to in section 282ZC, where a prospectus or profile statement is prepared and issued in relation to the offer, and—
 (a) a false or misleading statement is contained in—
 (i) the prospectus or the profile statement; or
 (ii) any application form for the units or derivatives of units;
 (b) there is an omission to state any information required to be included in the prospectus under section 282F or there is an omission to state any information required to be included in the profile statement under section 282G, as the case may be; or
 (c) there is an omission to state a new circumstance that—
 (i) has arisen since the prospectus or the profile statement was lodged with the Authority; and
 (ii) would have been required to be included in the prospectus under section 282F, or required to be included in the profile statement under section 282G, as the case may be, if it had arisen before the prospectus or the profile statement was lodged with the Authority,
 the persons referred to in subsection (4) shall be guilty of an offence even if such persons, unless otherwise specified, were not involved in the making of the false or misleading statement or the omission, and shall be liable on conviction to a fine not exceeding \$150,000 or to imprisonment for a term not

continued on next page

Box A1.1 continuation

exceeding 2 years or to both and, in the case of a continuing offence, to a further fine not exceeding \$15,000 for every day or part thereof during which the offence continues after conviction.

[1/2005]

(2) For the purposes of subsection (1), a false or misleading statement about a future matter (including the doing of, or the refusal to do, an act) is taken to have been made if a person made the statement without having reasonable grounds for making the statement.

[1/2005]

(3) A person shall not be taken to have contravened subsection (1) if the false or misleading statement, or the omission to state any information or new circumstance, is not materially adverse from the point of view of the investor.

[1/2005]

(4) The persons guilty of the offence are—

(a) the person making the offer;

(b) where the person making the offer is an entity—

(i) each director or equivalent person of the entity; and

(ii) if the entity is also the issuer, each person who is, and who has consented to be, named in the prospectus or profile statement as a proposed director or an equivalent person of the entity;

(c) where the issuer is controlled by the person making the offer, one or more of the related parties of the person making the offer, or the person making the offer and one or more of his related parties—

(i) the issuer;

(ii) each director or equivalent person of the issuer; and

(iii) each person who is, and who has consented to be, named in the prospectus or profile statement as a proposed director or an equivalent person of the issuer;

(d) an issue manager to the offer of the units or derivatives of units in the business trust who is, and who has consented to be, named in the prospectus or profile statement, if—

(i) he intentionally or recklessly makes the false or misleading statement or omits to state the information or circumstance;

(ii) knowing that the statement in the prospectus or profile statement is false or misleading or that the information or circumstance has been omitted, he fails to take such remedial action as is appropriate in the circumstances without delay; or

(iii) he is reckless as to whether the statement is false or misleading or whether the information or circumstance has been included;

(e) an underwriter (but not a sub-underwriter) to the issue or sale of the units or derivatives of units in the business trust who is, and who has consented to be, named in the prospectus or profile statement, if—

(i) he intentionally or recklessly makes the false or misleading statement or omits to state the information or circumstance;

(ii) knowing that the statement is false or misleading or that the information or circumstance has been omitted, he fails to take such remedial action as is appropriate in the circumstances without delay; or

(iii) he is reckless as to whether the statement is false or misleading or whether the information or circumstance has been included;

(f) a person named in the prospectus or the profile statement with his consent as having made—

(i) the statement that is false or misleading, if he intentionally or recklessly makes that statement; or

(ii) a statement on which the false or misleading statement is based, if he knows that the second-mentioned statement is false or misleading and fails to take immediate steps to withdraw his consent, but only in respect of the inclusion of the false or misleading statement; and

(g) any other person who intentionally or recklessly makes the false or misleading statement, or omits to state the information or circumstance, as the case may be, but only in respect of the inclusion of the statement or the omission to state the information or circumstance, as the case may be.

[1/2005]

(5) For the purposes of subsection (4) and this subsection—

(a) remedial action includes any of the following:

(i) preventing the statement from being included, or having the information or circumstance included, in the prospectus or profile statement, as the case may be;

(ii) procuring the lodgment of a supplementary or replacement prospectus under section 282D; and

(b) a person is reckless as to the matter referred to in subsection (4) (d) (iii) or (e) (iii) if, having been put upon inquiry that the statement to be, or which has been, included in the prospectus or profile statement is likely to be false or misleading, that the information or circumstance is likely to be required to be included in that document, or that there is likely to be an omission to state the information or circumstance in that document, he fails to—

(i) make all inquiries as are reasonable in the circumstances to verify this; and

(ii) take such remedial action as is appropriate in the circumstances without delay, if such action is warranted by the outcome of the inquiries.

[1/2005]

(6) For the purposes of this section, any reference to a statement shall include a reference to any information presented, regardless of whether such information is in text or otherwise.

[1/2005]

[SFA, s. 253]

Civil liability for false or misleading statements

2820.—(1) Where an offer of units or derivatives of units in a business trust is made in or accompanied by a prospectus or profile statement, or, in the case of an offer referred to in section 282ZC, where a prospectus or profile statement is prepared and issued in relation to the offer, and—

(a) a false or misleading statement is contained in—

continued on next page

Box A1.1 continuation

- (i) the prospectus or the profile statement; or
 - (ii) any application form for the units or derivatives of units;
 - (b) there is an omission to state any information required to be included in the prospectus under section 282F or there is an omission to state any information required to be included in the profile statement under section 282G, as the case may be; or
 - (c) there is an omission to state a new circumstance that—
 - (i) has arisen since the prospectus or the profile statement was lodged with the Authority; and
 - (ii) would have been required to be included in the prospectus under section 282F, or required to be included in the profile statement under section 282G, as the case may be, if it had arisen before the prospectus or the profile statement was lodged with the Authority,
- the persons referred to in subsection (3) shall be liable to compensate any person who suffers loss or damage as a result of the false or misleading statement in or omission from the prospectus or the profile statement, even if such persons, unless otherwise specified, were not involved in the making of the false or misleading statement or the omission.

[1/2005]

(2) For the purposes of subsection (1), a false or misleading statement about a future matter (including the doing of, or the refusal to do, an act) is taken to have been made if a person makes the statement without having reasonable grounds for making the statement.

[1/2005]

(3) The persons liable are—

- (a) the person making the offer;
- (b) where the person making the offer is an entity—
 - (i) each director or equivalent person of the entity; and
 - (ii) if the entity is also the issuer, each person who is, and who has consented to be, named in the prospectus or profile statement as a proposed director or an equivalent person of the entity;
- (c) where the issuer is controlled by the person making the offer, one or more of the related parties of the person making the offer, or the person making the offer and one or more of his related parties—
 - (i) the issuer;
 - (ii) each director or equivalent person of the issuer; and
 - (iii) each person who is, and who has consented to be, named in the prospectus or the profile statement as a proposed director or an equivalent person of the issuer;
- (d) an issue manager to the offer of the units or derivatives of units in the business trust who is, and who has consented to be, named in the prospectus or the profile statement;
- (e) an underwriter (but not a sub-underwriter) to the issue or sale of the units or derivatives of units in the business trust who is, and who has consented to be, named in the prospectus or the profile statement;
- (f) a person named in the prospectus or the profile statement with his consent as having made a statement—
 - (i) that is included in the prospectus or the profile statement; or
 - (ii) on which a statement made in the prospectus or the profile statement is based, but only in respect of the inclusion of that statement; and
- (g) any other person who made the false or misleading statement or omitted to state the information or circumstance, as the case may be, but only in respect of the inclusion of the statement or the omission to state the information or circumstance.

[1/2005]

(4) A person who acquires units or derivatives of units in a business trust as a result of an offer that was made in or accompanied by a profile statement is taken to have acquired the units or derivatives of units in reliance on both the profile statement and the prospectus for the offer.

[1/2005]

(5) For the purposes of this section, any reference to a statement shall include a reference to any information presented, regardless of whether such information is in text or otherwise.

[1/2005]

(6) No action under subsection (1) shall be commenced after the expiration of 6 years from the date on which the cause of action arose.

[1/2005]

(7) This section shall not affect any liability that a person has under any other law.

[1/2005]

[SFA, s. 254]

Defences

282P—(1) A person referred to in section 282N (4) (a), (b) or (c) is not liable under section 282N (1), and a person referred to in section 282O (3) is not liable under section 282O (1), only because of a false or misleading statement in a prospectus or a profile statement if the person proves that he—

- (a) made all inquiries (if any) that were reasonable in the circumstances; and
- (b) after doing so, believed on reasonable grounds that the statement was not false or misleading.

[1/2005]

(2) A person referred to in section 282N (4) (a), (b) or (c) is not liable under section 282N (1), and a person referred to in section 282O (3) is not liable under section 282O (1), only because of an omission from a prospectus or a profile statement in relation to a particular matter if the person proves that he—

- (a) made all inquiries (if any) that were reasonable in the circumstances; and
- (b) after doing so, believed on reasonable grounds that there was no omission from the prospectus or profile statement in relation to that matter.

[1/2005]

(3) A person is not liable under section 282N (1) or 282O (1) only because of a false or misleading statement in, or an omission from, a prospectus or a

continued on next page

Box A1.1 continuation

profile statement if the person proves that he placed reasonable reliance on information given to him by—

(a) if the person is an entity, someone other than—

(i) a director or equivalent person; or

(ii) an employee or agent, of the entity; or

(b) if the person is an individual, someone other than an employee or agent of the individual.

[1/2005]

(4) For the purposes of subsection (3), a person is not the agent of an entity or individual merely because he performs a particular professional or advisory function for the entity or individual.

[1/2005]

(5) A person who is named in a prospectus or a profile statement as—

(a) a proposed director or equivalent person of the issuer, or an issue manager or underwriter;

(b) having made a statement included in the prospectus or the profile statement; or

(c) having made a statement on the basis of which a statement is included in the prospectus or the profile statement, is not liable under section 282N (1) or 282O (1) only because of a false or misleading statement in, or an omission from, the prospectus or the profile statement if the person proves that he publicly withdrew his consent to being named in the prospectus or the profile statement in that way.

[1/2005]

(6) A person is not liable under section 282N (1) or 282O (1) only because of a new circumstance that has arisen since the prospectus or the profile statement was lodged with the Authority if the person proves that he was not aware of the matter.

[1/2005]

(7) For the purposes of this section, any reference to a statement shall include a reference to any information presented, regardless of whether such information is in text or otherwise.

[1/2005]

[SFA, s. 255]

Document containing offer of units or derivatives of units for sale deemed prospectus

282Q.—(1) Subsection (2) applies where—

(a) an entity allots or agrees to allot to any person any units or derivatives of units in a business trust with a view to all or any of them being subsequently offered for sale to another person; and

(b) such offer (referred to in this section as a subsequent offer) does not qualify for an exemption under Subdivision (3) of this Division (other than section 282ZC).

[1/2005]

(2) Any document by which the subsequent offer is made shall for all purposes be deemed to be a prospectus issued by the entity, and the entity shall for all purposes be deemed to be the person making the offer, and all written laws and rules of law as to the contents of prospectuses and to liability in respect of statements and non-disclosure in prospectuses, or otherwise relating to prospectuses, shall apply and have effect accordingly as if—

(a) an offer of units or derivatives of units in the business trust has been made; and

(b) persons accepting the subsequent offer in respect of any units or derivatives of units in the business trust were subscribers therefor, but without prejudice to the liability, if any, of the persons making the subsequent offer, in respect of statements or non-disclosures in the document or otherwise.

[1/2005]

(3) For the purposes of this Act, it shall, unless the contrary is proved, be sufficient evidence that an allotment of, or an agreement to allot, units or derivatives of units in a business trust was made with a view to the units or derivatives of units being subsequently offered for sale if it is shown—

(a) that an offer of the units or derivatives of units or of any of them for sale was made within 6 months after the allotment or agreement to allot; or

(b) that at the date when the offer was made the whole consideration to be received by the entity in respect of the units or derivatives of units had not been so received.

[1/2005]

(4) The requirements of this Division as to prospectuses shall have effect as though the persons making the subsequent offer were persons named in the prospectus as directors or equivalent persons of the entity.

[1/2005]

(5) In addition to complying with the other requirements of this Division, the document making the subsequent offer shall state—

(a) the net amount of the consideration received or to be received by the entity in respect of the units or derivatives of units in the business trust being offered; and

(b) the place and time at which a copy of the contract under which the units or derivatives of units in the business trust have been or are to be allotted may be inspected.

[1/2005]

[SFA, s. 257]

Application and moneys to be held in trust in separate bank account until allotment

282R.—(1) All application and other moneys paid prior to allotment by any applicant on account of units or derivatives of units in a business trust offered to him shall, until the allotment of the units or derivatives of units in the business trust, be held by the person making the offer of the units or derivatives of units upon trust for the applicant in a separate bank account, being a bank account that is established and kept by the person solely for the purpose of depositing the application and other moneys that are paid by applicants for those units or derivatives of units.

[1/2005]

(2) There shall be no obligation or duty on any bank with which any such moneys have been deposited to enquire into or see to the proper application of

continued on next page

Box A1.1 continuation

those moneys, so long as the bank acts in good faith.

[1/2005]

(3) Any person who contravenes subsection (1) shall be guilty of an offence and shall be liable on conviction to a fine not exceeding \$50,000 or to imprisonment for a term not exceeding 2 years or to both and, in the case of a continuing offence, to a further fine not exceeding \$5,000 for every day or part thereof during which the offence continues after conviction.

[1/2005]

[SFA, s. 258]

Allotment of units or derivatives of units where prospectus indicates application to list on securities exchange

282S.—(1) Where a prospectus states or implies that application has been or will be made for permission for the units or derivatives of units in a business trust offered thereby to be listed for quotation on any securities exchange, and—

(a) the permission is not applied for in the form required by the securities exchange within 3 days from the date of the issue of the prospectus; or
(b) the permission is not granted before the expiration of 6 weeks from the date of the issue of the prospectus or such longer period not exceeding 12 weeks from the date of the issue as is, within those 6 weeks, notified to the applicant by or on behalf of the securities exchange, then—

(i) any allotment whenever made of units or derivatives of units made on an application in pursuance of the prospectus shall, subject to subsection (3), be void; and

(ii) any person who continues to allot such units or derivatives of units after the period specified in paragraph (a) or (b), shall be guilty of an offence and shall be liable on conviction to a fine not exceeding \$150,000 or to imprisonment for a term not exceeding 2 years or to both and, in the case of a continuing offence, to a further fine not exceeding \$15,000 for every day or part thereof during which the offence continues after conviction.

[1/2005]

(2) Where, the permission has not been applied for, or has not been granted as mentioned under subsection (1), the person making the offer shall, subject to subsection (3), immediately repay without interest all moneys received from applicants in pursuance of the prospectus, and if any such moneys is not repaid within 14 days after the person making the offer so becomes liable to repay them, then—

(a) he shall be liable to repay those moneys with interest at the rate of 10% per annum from the expiration of such 14 days; and

(b) where the person making the offer is an entity, in addition to the liability of the entity, the directors or equivalent persons of the entity shall be jointly and severally liable to repay those moneys with interest at the rate of 10% per annum from the expiration of such 14 days.

[1/2005]

(3) Where in relation to any units or derivatives of units in a business trust—

(a) permission is not applied for as specified in subsection (1) (a); or

(b) permission is not granted as specified in subsection (1) (b),

the Authority may, on the application of the issuer made before any of the units or derivatives of units is purported to be allotted, exempt the allotment of the units or derivatives of units from the provisions of this section, and the Authority shall give notice of such exemption in the Gazette.

[1/2005]

(4) A director or equivalent person shall not be liable under subsection (2) if he proves that the default in the repayment of the money was not due to any misconduct or negligence on his part.

[1/2005]

(5) Any condition requiring or binding any applicant for units or derivatives of units in a business trust to waive compliance with any requirement of this section or purporting to do so shall be void.

[1/2005]

(6) Without limiting the application of any of its provisions, this section shall have effect—

(a) in relation to any units or derivatives of units in a business trust agreed to be taken by a person underwriting an offer thereof contained in a prospectus as if he had applied therefor in pursuance of the prospectus; and

(b) in relation to a prospectus offering units or derivatives of units in a business trust for sale as if a reference to sale were substituted for a reference to allotment.

[1/2005]

(7) All moneys received from applicants in pursuance of the prospectus shall be kept in a separate bank account so long as the person making the offer may become liable to repay it under subsection (2).

[1/2005]

(8) Any person who contravenes subsection (7) shall be guilty of an offence and shall be liable on conviction to a fine not exceeding \$50,000 or to imprisonment for a term not exceeding 12 months or to both and, in the case of a continuing offence, to a further fine not exceeding \$5,000 for every day or part thereof during which the offence continues after conviction.

[1/2005]

(9) Where the securities exchange has within the time specified in subsection (1) (b) granted permission subject to compliance with any requirements specified by the securities exchange, permission shall be deemed to have been granted by the securities exchange if the directors or equivalent persons of the issuer have given to the securities exchange an undertaking in writing to comply with the requirements of the securities exchange.

[1/2005]

(10) If any such undertaking referred to in subsection (9) is not complied with, each director or equivalent person who is in default shall be guilty of an offence and shall be liable on conviction to a fine not exceeding \$50,000 and, in the case of a continuing offence, to a further fine not exceeding \$5,000 for every day or part thereof during which the offence continues after conviction.

[1/2005]

continued on next page

Box A1.1 continuation

(11) A person shall not issue a prospectus inviting persons to subscribe for units or derivatives of units in a business trust if it includes—

- (a) a false or misleading statement that permission has been granted for those units or derivatives of units to be listed for quotation on, dealt in or quoted on any securities exchange; or
- (b) any statement in any way referring to any such permission or to any application or intended application for any such permission, or to listing for quotation, dealing in or quoting the units or derivatives of units, on any securities exchange, or to any requirement of a securities exchange, unless—
 - (i) that statement is or is to the effect that permission has been granted, or that application has been or will be made to the securities exchange within 3 days from the date of the issue of the prospectus; or
 - (ii) that statement has been approved by the Authority for inclusion in the prospectus.

[1/2005]

(12) Any person who contravenes subsection (11) shall be guilty of an offence and shall be liable on conviction to a fine not exceeding \$50,000 or to imprisonment for a term not exceeding 12 months or to both and, in the case of a continuing offence, to a further fine not exceeding \$5,000 for every day or part thereof during which the offence continues after conviction.

[1/2005]

(13) Where a prospectus contains a statement to the effect that the trust deed of a business trust or the memorandum and articles or other constituent document or documents of the issuer comply, or have been drawn so as to comply, with the requirements of any securities exchange, the prospectus shall, unless the contrary intention appears from the prospectus, be deemed for the purposes of this section to imply that application has been, or will be, made for permission for the units or derivatives of units in the business trust to which the prospectus relates to be listed for quotation on the securities exchange.

[1/2005]

[SFA, s. 259]

Prohibition of allotment unless minimum subscription received

282T.—(1) No allotment shall be made of any units or derivatives of units in a business trust unless—

- (a) the minimum subscription has been subscribed; and
- (b) the sum payable on application for the units or derivatives of units so subscribed has been received by the trustee-manager of the business trust, but if a cheque for the sum payable has been received by the trustee-manager, the sum shall be deemed not to have been received by the trustee-manager until the cheque is paid by the bank on which it is drawn.

[1/2005]

(2) The minimum subscription shall—

- (a) be calculated based on the price at which each unit or derivative of a unit is offered or will be offered; and
- (b) be reckoned exclusively of any amount payable otherwise than in cash.

[1/2005]

(3) The amount payable on application for each unit or derivative of a unit offered shall not be less than 5% of the price at which the unit or derivative of a unit is or will be offered.

[1/2005]

(4) If the conditions referred to in subsection (1) (a) and (b) have not been satisfied on the expiration of 4 months after the first issue of the prospectus, all moneys received from applicants for units or derivatives of units in the business trust shall be immediately repaid to them without interest.

[1/2005]

(5) If any money referred to in subsection (4) is not repaid within 5 months after the issue of the prospectus, the directors of the trustee-manager of the business trust shall be jointly and severally liable to repay that money with interest at the rate of 10% per annum from the expiration of the period of 5 months; but a director shall not be so liable if he proves that the default in the repayment of the money was not due to any misconduct or negligence on his part.

[1/2005]

(6) An allotment made by the trustee-manager of a business trust of any units or derivatives of units in the business trust to an applicant in contravention of this section shall be voidable at the option of the applicant, whose option may be exercised by written notice served on the trustee-manager of the business trust within one month after the date of the allotment and not later, and the allotment shall be so voidable notwithstanding that the business trust is in the course of being wound up.

[1/2005]

(7) The trustee-manager of a business trust which contravenes any of the provisions of this section, and every director of a trustee-manager who knowingly contravenes or permits or authorises the contravention of any of the provisions of this section, shall be guilty of an offence and shall be liable in addition to the penalty or punishment for the offence to pay into the trust property of the business trust and compensate the allottee respectively for any loss, damages or costs which the business trust (represented by any diminishment in value to the trust property of the business trust) or the allottee has sustained or incurred thereby.

[1/2005]

(8) No proceedings for the recovery of any compensation under subsection (7) shall be commenced after the expiration of 2 years from the date of the allotment.

[1/2005]

(9) Any condition requiring or binding any applicant for units or derivatives of units in a business trust to waive compliance with any requirement of this section shall be void.

[1/2005]

[SFA, s. 260]

continued on next page

Box A1.1 continuation

Subdivision (3)—Exemptions

Issue or transfer of units or derivatives of units for no consideration

282U.—(1) Subdivision (2) of this Division (other than section 282Q) shall not apply to an offer of units in a business trust if no consideration is or will be given for the issue or transfer of the units.

[1/2005]

(2) Subdivision (2) of this Division (other than section 282Q) shall not apply to an offer of derivatives of units in a business trust if—

- (a) no consideration is or will be given for the issue or transfer of the derivatives of units; and
- (b) no consideration is or will be given for the units in the business trust on the exercise or conversion of the derivatives of units.

[1/2005]

Small offers

282V.—(1) Subdivision (2) of this Division (other than section 282Q) shall not apply to personal offers of units or derivatives of units in a business trust by a person if—

(a) the total amount raised by the person from such offers within any period of 12 months does not exceed—

- (i) \$5 million (or its equivalent in a foreign currency); or
- (ii) such other amount as may be prescribed by the Authority in substitution for the amount specified in sub-paragraph (i);

(b) in respect of each offer, the person making the offer—

(i) gives the person to whom he makes the offer—

(A) in the case where the business trust is not registered under the Business Trusts Act (Cap. 31A), the following statement in writing:

“This offer is made in reliance on the exemption under section 282V (1) of the Securities and Futures Act. It is not made in or accompanied by a prospectus that is registered by the Monetary Authority of Singapore and the business trust is not registered under the Business Trusts Act.”; and

(B) in the case where the business trust is registered under the Business Trusts Act, the following statement in writing:

“This offer is made in reliance on the exemption under section 282V (1) of the Securities and Futures Act. It is not made in or accompanied by a prospectus that is registered by the Monetary Authority of Singapore.”; and

(ii) gives the person to whom he makes the offer a notification in writing that the units or derivatives of units to which the offer (referred to in this sub-paragraph as the initial offer) relates shall not be subsequently sold to any person, unless the offer resulting in such subsequent sale is made—

(A) in compliance with Subdivision (2) of this Division;

(B) in reliance on subsection (8) (c) or any other exemption under any provision of this Subdivision (other than this subsection); or

(C) where at least 6 months have elapsed from the date the units or derivatives of units were acquired under the initial offer, in reliance on the exemption under this subsection;

(c) none of the offers is accompanied by an advertisement making an offer or calling attention to the offer or intended offer;

(d) no selling or promotional expenses are paid or incurred in connection with each offer other than those incurred for administrative or professional services, or by way of commission or fee for services rendered by—

(i) the holder of a capital markets services licence to deal in securities;

(ii) an exempt person in respect of dealing in securities; or

(iii) a person who is licensed, approved, authorised or otherwise regulated under the laws, codes or other requirements of any foreign jurisdiction in respect of dealing in securities, or who is exempted therefrom in respect of such dealing; and

[1/2005]

(e) no prospectus in respect of any of the offers has been registered by the Authority or, where a prospectus has been registered—

(i) the prospectus has expired pursuant to section 282K; or

(ii) the person making the offer has before making the offer informed the Authority by notice in writing of its intent to make the offer in reliance on the exemption under this subsection.

(2) For the purposes of subsection (1) (b), where any notice, circular, material, publication or other document is issued in connection with the offer, the person making the offer is deemed to have given the statement and notification to the person to whom he makes the offer in accordance with that provision if such statement or notification is contained in the first page of that notice, circular, material, publication or document.

[1/2005]

(3) For the purposes of subsection (1), a personal offer of units or derivatives of units in a business trust is one that—

(a) may be accepted only by the person to whom it is made; and

(b) is made to a person who is likely to be interested in that offer, having regard to—

(i) any previous contact before the date of the offer between the person making the offer and that person;

(ii) any previous professional or other connection established before that date between the person making the offer and that person; or

(iii) any previous indication (whether through statements made or actions carried out) before that date by that person that indicate to—

(A) the person making the offer;

(B) the holder of a capital markets services licence to deal in securities;

(C) an exempt person in respect of dealing in securities;

(D) a person licensed under the Financial Advisers Act (Cap. 110) in respect of the provision of financial advisory services concerning investment products;

(E) an exempt financial adviser as defined in section 2 (1) of the Financial Advisers Act; or

(F) a person who is licensed, approved, authorised or otherwise regulated under the laws, codes or other requirements of any foreign jurisdiction in respect of dealing in securities or the provision of financial advisory services concerning investment products, or who is exempted therefrom in respect of such dealing or the provision of such services,

continued on next page

Box A1.1 continuation

that he is interested in offers of that kind.

[1/2005]

(4) In determining the amount raised by an offer, the following shall be included:

- (a) the amount payable for the units or derivatives of units in a business trust at the time they are allotted, issued or sold;
- (b) if the units or derivatives of units in a business trust are issued partly-paid, any amount payable at a future time if a call is made;
- (c) if the units or derivatives of units in a business trust carry a right (by whatever name called) to be converted into other units or derivatives of units in the business trust or to acquire other units or derivatives of units in the business trust, any amount payable on the exercise of the right to convert them into, or to acquire, other units or derivatives of units.

[1/2005]

(5) In determining whether the amount raised by a person from offers within a period of 12 months exceeds the applicable amount specified in subsection (1) (a), each amount raised—

- (a) by that person from any offer of units or derivatives of units in a business trust issued by the same entity; or
- (b) by that person or another person from any offer of securities which is a closely related offer, if any, within that period in reliance on the exemption under subsection (1), section 272A (1) or 302B (1) shall be included.

[1/2005]

(6) Whether an offer is a closely related offer under subsection (5) shall be determined by considering such factors as the Authority may prescribe.

[1/2005]

(7) For the purpose of this section, an offer of units or derivatives of units in a business trust made by a person acting as an agent of another person shall be treated as an offer made by that other person.

[1/2005]

(8) Where units or derivatives of units in a business trust acquired through an offer made in reliance on the exemption under subsection (1) (referred to in this subsection as an initial offer) are subsequently sold by the person who acquired the units or derivatives of units to another person, Subdivision (2) of this Division shall apply to the offer from the first-mentioned person to the second-mentioned person which resulted in that sale, unless—

- (a) such offer is made in reliance on an exemption under any provision of this Subdivision (other than this section);
- (b) such offer is made in reliance on an exemption under subsection (1) and at least 6 months have elapsed from the date the units or derivatives of units were acquired under the initial offer; or
- (c) such offer is one—
 - (i) that may be accepted only by the person to whom it is made;
 - (ii) that is made to a person who is likely to be interested in the offer having regard to—
 - (A) any previous contact before the date of the offer between the person making the initial offer and that person;
 - (B) any previous professional or other connection established before that date between the person making the initial offer and that person; or
 - (C) any previous indication (whether through statements made or actions carried out) before that date by that person that indicate to—
 - (CA) the person making the initial offer;
 - (CB) the holder of a capital markets services licence to deal in securities;
 - (CC) an exempt person in respect of dealing in securities;
 - (CD) a person licensed under the Financial Advisers Act (Cap. 110) in respect of the provision of financial advisory services concerning investment products;
 - (CE) an exempt financial adviser as defined in section 2 (1) of the Financial Advisers Act (Cap. 110); or
 - (CF) a person who is licensed, approved, authorised or otherwise regulated under the laws, codes or other requirements of any foreign jurisdiction in respect of dealing in securities or the provision of financial advisory services concerning investment products, or who is exempted therefrom in respect of such dealing or the provision of such services,
 - (iii) in respect of which the first-mentioned person has given the second-mentioned person—
 - (A) the following statement in writing—
 - (AA) in the case where the business trust is not registered under the Business Trusts Act (Cap. 31A)—
 - “This offer is made in reliance on the exemption under section 282V (8) (c) of the Securities and Futures Act. It is not made in or accompanied by a prospectus that is registered by the Monetary Authority of Singapore and the business trust is not registered under the Business Trusts Act.”; and
 - (AB) in the case where the business trust is registered under the Business Trusts Act—
 - “This offer is made in reliance on the exemption under section 282V (8) (c) of the Securities and Futures Act. It is not made in or accompanied by a prospectus that is registered by the Monetary Authority of Singapore.”; and
 - (B) a notification in writing that the units or derivatives of units being offered shall not be subsequently sold to any person unless the offer resulting in such subsequent sale is made—
 - (BA) in compliance with Subdivision (2) of this Division;
 - (BB) in reliance on this subsection or any other exemption under any provision of this Subdivision (other than subsection (1)); or
 - (BC) where at least 6 months have elapsed from the date the units or derivatives of units were acquired under the initial offer, in reliance on the exemption under subsection (1);
 - (iv) that is not accompanied by an advertisement making an offer or calling attention to the offer or intended offer; and
 - (v) in respect of which no selling or promotional expenses are paid or incurred in connection with the offer other than those incurred for administrative or professional services, or by way of commission or fee for services rendered by—
 - (A) the holder of a capital markets services licence to deal in securities;
 - (B) an exempt person in respect of dealing in securities; or

continued on next page

Box A1.1 continuation

(C) a person who is licensed, approved, authorised or otherwise regulated under the laws, codes or other requirements of any foreign jurisdiction in respect of dealing in securities, or who is exempted therefrom in respect of such dealing.

[1/2005]

(9) Subsection (2) shall apply, with the necessary modifications, in relation to the statement and notification referred to in subsection (8) (c) (iii).

[1/2005]

(10) In subsections (1) (c) and (8) (c) (iv), “advertisement” means—

(a) a written or printed communication;

(b) a communication by radio, television or other medium of communication; or

(c) a communication by means of a recorded telephone message,

that is published in connection with an offer of units or derivatives of units in a business trust, but does not include—

(i) a document—

(A) purporting to describe the units or derivatives of units being offered, or the business and affairs of the person making the offer, the issuer, the trustee of the business trust or the business trust; and

(B) purporting to have been prepared for delivery to and review by persons to whom the offer is made so as to assist them in making an investment decision in respect of the units or derivatives of units being offered;

(ii) a publication which consists solely of a disclosure, notice or report required under this Act, or any listing rules or other requirements of a securities exchange, futures exchange or overseas securities exchange, which is made by any person; or

(iii) a publication which consists solely of a notice or report of a general meeting or proposed general meeting of the person making the offer, the issuer, the trustee of the business trust or any entity, a notice or report of a general meeting or proposed general meeting of the unit holders of the business trust, or a presentation of oral or written material on matters so contained in the notice or report at the general meeting.

[1/2005]

(11) In subsection (10) (i) (A), the reference to the affairs of the person making the offer, the issuer, the trustee of the business trust or the business trust shall—

(a) in the case where the person making the offer, the issuer or the trustee of the business trust is a corporation, be construed as including a reference to the matters referred to in section 2 (2);

(b) in the case where the person making the offer, the issuer or the trustee of the business trust is not a corporation, be construed as referring to such matters as may be prescribed by the Authority; and

(c) in the case of the business trust, be construed as referring to such matters as may be prescribed by the Authority.

[1/2005]

Private placement

282W.—(1) Subdivision (2) of this Division (other than section 282Q) shall not apply to offers of units or derivatives of units in a business trust that are made by a person if—

(a) the offers are made to no more than 50 persons within any period of 12 months;

(b) none of the offers is accompanied by an advertisement making an offer or calling attention to the offer or intended offer;

(c) no selling or promotional expenses are paid or incurred in connection with each offer other than those incurred for administrative or professional services, or by way of commission or fee for services rendered by—

(i) the holder of a capital markets services licence to deal in securities;

(ii) an exempt person in respect of dealing in securities; or

(iii) a person who is licensed, approved, authorised or otherwise regulated under the laws, codes or other requirements of any foreign jurisdiction in respect of dealing in securities, or who is exempted therefrom in respect of such dealing; and

[1/2005]

(d) no prospectus in respect of any of the offers has been registered by the Authority or, where a prospectus has been registered—

(i) the prospectus has expired pursuant to section 282K; or

(ii) the person making the offer has before making the offer—

(A) informed the Authority by notice in writing of its intent to make the offer in reliance on the exemption under this subsection; and

(B) taken reasonable steps to inform in writing the person to whom the offer is made that the offer is made in reliance on the exemption under this subsection.

(2) The Authority may prescribe such other number of persons in substitution for the number specified in subsection (1) (a).

[1/2005]

(3) In determining whether offers of units or derivatives of units in a business trust by a person are made to no more than the applicable number of persons specified in subsection (1) (a) within a period of 12 months, each person to whom—

(a) an offer of units or derivatives of units issued by the same entity is made by the first-mentioned person; or

(b) an offer of securities is made by the first-mentioned person or another person where such offer is a closely related offer, if any, within that period in reliance on the exemption under this section, section 272B or 302C shall be included.

[1/2005]

(4) Whether an offer is a closely related offer under subsection (3) shall be determined by considering such factors as the Authority may prescribe.

[1/2005]

(5) For the purposes of subsection (1)—

(a) an offer of units or derivatives of units in a business trust to an entity or to a trustee shall be treated as an offer to a single person, provided that the entity or trust is not formed primarily for the purpose of acquiring the units or derivatives of units which are the subject of the offer;

(b) an offer of units or derivatives of units in a business trust to an entity or to a trustee shall be treated as an offer to the equity owners, partners or

continued on next page

Box A1.1 continuation

members of that entity, or to the beneficiaries of the trust, as the case may be, if the entity or trust is formed primarily for the purpose of acquiring the units or derivatives of units which are the subject of the offer;

(c) an offer of units or derivatives of units in a business trust to 2 or more persons who will own the units or derivatives of units acquired as joint owners shall be treated as an offer to a single person;

(d) an offer of units or derivatives of units in a business trust to a person acting on behalf of another person (whether as an agent or otherwise) shall be treated as an offer made to that other person;

(e) offers of units or derivatives of units in a business trust made by a person as an agent of another person shall be treated as offers made by that other person;

(f) where an offer is made to a person with a view to another person acquiring an interest in those units or derivatives of units in a business trust by virtue of section 4, only the second-mentioned person shall be counted for the purposes of determining whether offers of the units or derivatives of units are made to no more than the applicable number of persons specified in subsection (1) (a); and

(g) where—

(i) an offer of units or derivatives of units in a business trust is made to a person in reliance on the exemption under subsection (1) with a view to those units or derivatives of units being subsequently offered for sale to another person; and

(ii) that subsequent offer—

(A) is not made in reliance on an exemption under any provision of this Subdivision; or

(B) is made in reliance on an exemption under subsection (1) or section 282ZC,

both persons shall be counted for the purposes of determining whether offers of the units or derivatives of units are made to no more than the applicable number of persons specified in subsection (1) (a).

[1/2005]

(6) In subsection (1) (b), “advertisement” has the same meaning as in section 282V (10).

[1/2005]

Offer made under certain circumstances

282X.—(1) Subdivision (2) of this Division (other than subsection (1) (a) of sections 282C and 282Q) shall not apply to an offer of units or derivatives of units in a business trust if—

(a) it is made in connection with a take-over offer which is in compliance with the Take-over Code;

(b) it is made in connection with an offer for the acquisition by or on behalf of a person of some or all of the shares in a corporation or some or all of the shares of a particular class in a corporation—

(i) to all members of the corporation or all members of the corporation holding shares of that class; or

(ii) where the person already holds shares in the corporation, to all other members of the corporation or all other members of the corporation holding shares of that class,

and such offer complies with the Take-over Code as though the Take-over Code were applicable to it;

(c) it is made in connection with a proposed compromise or arrangement between—

(i) a corporation and its creditors or a class of them; or

(ii) a corporation and its members or a class of them,

and such proposed compromise or arrangement and the execution thereof complies with the Take-over Code as though the Take-over Code were applicable to it;

(d) it is an offer of units in a business trust (not being such excluded units in a business trust, or units in such excluded business trust, as may be prescribed by the Authority) that have been previously issued, are listed for quotation or quoted on a securities exchange, and are traded on the exchange;

(e) it is an offer of derivatives of units in a business trust (not being such excluded derivatives of units in a business trust, or derivatives of units in such excluded business trust, as may be prescribed by the Authority) where—

(i) the derivatives of units have been previously issued, are listed for quotation or quoted on a securities exchange, and are traded on the exchange; or

(ii) an application has been or will be made for permission for the derivatives of units to be listed for quotation or quoted on a securities exchange and the units have been previously issued and are listed for quotation on a securities exchange or a recognised securities exchange;

(f) it is an offer of units in a business trust made to any existing unit holder of the business trust or any holder of debentures of the trustee-manager issued in its capacity as trustee-manager of the business trust whose units are listed for quotation on a securities exchange; or

(g) it is an offer of derivatives of units in a business trust made to any existing unit holder of the business trust or any holder of debentures of the trustee-manager issued in its capacity as trustee-manager of the business trust whose units are listed for quotation on a securities exchange, where such derivatives of units may only be exercised or converted by any existing unit holder or holder of debentures into units of the business trust.

[1/2005]

(2) An offer of units or derivatives of units in a business trust does not come within subsection (1) (d) or (e) if—

(a) the units or derivatives of units being offered are borrowed by the issuer from an existing unit holder or holder of derivatives of units, solely for the purpose of facilitating the offer of units or derivatives of units by the issuer; and

(b) such borrowing is made under an agreement or arrangement between the issuer and the unit holder or holder which promises the issue or allotment of units or derivatives of units by the issuer to the unit holder or holder at the same time or shortly after the offer.

[1/2005]

(3) Subdivision (2) of this Division (other than section 282Q) shall not apply to an offer of units or derivatives of units in a business trust if—

(a) it is made in connection with an offer for the acquisition by or on behalf of a person of some or all of the shares in an unlisted corporation or some or all of the shares of a particular class in an unlisted corporation—

(i) to all members of the corporation or all members of the corporation holding shares of that class; or

continued on next page

Box A1.1 continuation

(ii) where the person already holds shares in the corporation, to all other members of the corporation or all other members of the corporation holding shares of that class,

where such offer is in compliance with the laws, codes and other requirements (whether or not having the force of law) relating to take-overs of the country in which the corporation was incorporated;

(b) it is made in connection with a proposed compromise or arrangement between—

(i) an unlisted corporation and its creditors or a class of them; or

(ii) an unlisted corporation and its members or a class of them,

and such proposed compromise or arrangement and the execution thereof is in compliance with the laws, codes and other requirements (whether or not having the force of law) relating to take-overs, compromises and arrangements of the country in which the corporation was incorporated;

(c) it is made (whether or not in relation to units or derivatives of units in a business trust that have been previously issued) by the trustee of the business trust to a qualifying person, where the units or derivatives of units are to be held by or for the benefit of the qualifying person and are the units or derivatives of units of the business trust or the securities of any of its related parties;

(d) it is an offer to enter into an underwriting agreement relating to units or derivatives of units in a business trust; or

(e) it is an offer of units or derivatives of units in a business trust—

(i) being a business trust which is registered in Singapore or otherwise, whose units or derivatives of units are not listed for quotation on a securities exchange; or

(ii) being a business trust which is not registered in Singapore, whose units or derivatives of units are listed for quotation on a securities exchange and such listing is not a primary listing,

that is made to existing unit holders of the business trust or holders of debentures of the trustee issued in its capacity as trustee of the business trust (whether or not it is renounceable in favour of persons other than existing unit holders or holders of debentures).

[1/2005]

(4) An offer of units or derivatives of units in a business trust comes within subsection (3) (c) only if no selling or promotional expenses are paid or incurred in connection with the offer other than those incurred for administrative or professional services, or by way of commission or fee for services rendered by—

(a) the holder of a capital markets services licence to deal in securities;

(b) an exempt person in respect of dealing in securities; or

(c) a person who is licensed, approved, authorised or otherwise regulated under the laws, codes or other requirements of any foreign jurisdiction in respect of dealing in securities, or who is exempted therefrom in respect of such dealings.

[1/2005]

(5) For the purposes of subsection (3) (c), a person is a qualifying person in relation to a business trust if he is a bona fide director or equivalent person, former director or equivalent person, consultant, adviser, employee or former employee of the trustee of the business trust or a related corporation of that trustee (being a corporation), or if he is the spouse, widow, widower or a child, adopted child or step-child below the age of 18, of such director or equivalent person, former director or equivalent person, employee or former employee.

[1/2005]

(6) Where, on the application of any person interested, the Authority declares that circumstances exist whereby—

(a) the cost of providing a prospectus for an offer of units or derivatives of units in a business trust outweighs the resulting protection to investors; or

(b) it would not be prejudicial to the public interest if a prospectus were dispensed with for an offer of units or derivatives of units in a business trust, then Subdivision (2) of this Division (other than section 282Q) shall not apply to such offer for a period of 6 months from the date of the declaration.

[1/2005]

(7) The Authority may, on making a declaration under subsection (6), impose such conditions or restrictions on the offer as the Authority may determine.

[1/2005]

(8) A declaration made under subsection (6) shall be final.

[1/2005]

(9) Any person who contravenes any of the conditions or restrictions specified in the declaration made under subsection (6) shall be guilty of an offence and shall be liable on conviction to a fine not exceeding \$50,000 and, in the case of a continuing offence, to a further fine not exceeding \$5,000 for every day or part thereof during which the offence continues after conviction.

[1/2005]

(10) In subsection (1) (b) and (c), "corporation" means a corporation that is not a company.

[1/2005]

(11) In subsection (3) (a) and (b), "unlisted corporation" means a corporation—

(a) that is not a company; and

(b) the shares or debentures, or units of shares or debentures of which are not listed for quotation on any securities exchange.

[1/2005]

[SFA, s. 273]

Offer made to institutional investors

282Y. Subdivision (2) of this Division (other than section 282Q) shall not apply to an offer of units or derivatives of units in a business trust, whether or not they have been previously issued, made to an institutional investor.

[1/2005]

[SFA, s. 274]

continued on next page

*Box A1.1 continuation***Offer made to accredited investors and certain other persons**

282Z.—(1) Subdivision (2) of this Division (other than section 282Q) shall not apply to an offer of units or derivatives of units in a business trust, whether or not they have been previously issued, where the offer is made to a relevant person, if—

- (a) the offer is not accompanied by an advertisement making an offer or calling attention to the offer or intended offer;
- (b) no selling or promotional expenses are paid or incurred in connection with the offer other than those incurred for administrative or professional services, or by way of commission or fee for services rendered by—
 - (i) the holder of a capital markets services licence to deal in securities;
 - (ii) an exempt person in respect of dealing in securities; or
 - (iii) a person who is licensed, approved, authorised or otherwise regulated under the laws, codes or other requirements of any foreign jurisdiction in respect of dealing in securities, or who is exempted therefrom in respect of such dealing; and

[1/2005]

(c) no prospectus in respect of the offer has been registered by the Authority or, where a prospectus has been registered—

- (i) the prospectus has expired pursuant to section 282K; or
- (ii) the person making the offer has before making the offer—
 - (A) informed the Authority by notice in writing of its intent to make the offer in reliance on the exemption under this subsection; and
 - (B) taken reasonable steps to inform in writing the person to whom the offer is made that the offer is made in reliance on the exemption under this subsection.

(2) Subdivision (2) of this Division (other than section 282Q) shall not apply to an offer of units or derivatives of units in a business trust to a person who acquires the units or derivatives of units as principal, whether or not the units or derivatives of units have been previously issued, if—

- (a) the offer is on terms that the units or derivatives of units may only be acquired at a consideration of not less than \$200,000 (or its equivalent in a foreign currency) for each transaction, whether such amount is to be paid for in cash or by exchange of securities or other assets;
- (b) the offer is not accompanied by an advertisement making an offer or calling attention to the offer, or intended offer;
- (c) no selling or promotional expenses are paid or incurred in connection with the offer other than those incurred for administrative or professional services, or by way of commission or fee for services rendered by—
 - (i) the holder of a capital markets services licence to deal in securities;
 - (ii) an exempt person in respect of dealing in securities; or
 - (iii) a person who is licensed, approved, authorised or otherwise regulated under the laws, codes or other requirements of any foreign jurisdiction in respect of dealing in securities, or who is exempted therefrom in respect of such dealing; and

[1/2005]

(d) no prospectus in respect of the offer has been registered by the Authority or, where a prospectus has been registered—

- (i) the prospectus has expired pursuant to section 282K; or
- (ii) the person making the offer has before making the offer—
 - (A) informed the Authority by notice in writing of its intent to make the offer in reliance on the exemption under this subsection; and
 - (B) taken reasonable steps to inform in writing the person to whom the offer is made that the offer is made in reliance on the exemption under this subsection.

(3) In this section—

“advertisement” means—

- (a) a written or printed communication;
 - (b) a communication by radio, television or other medium of communication; or
 - (c) a communication by means of a recorded telephone message,
- that is published in connection with an offer in respect of units or derivatives of units in a business trust, but does not include—
- (i) an information memorandum;

(ii) a publication which consists solely of a disclosure, notice or report required under this Act, or any listing rules or other requirements of a securities exchange, futures exchange or overseas securities exchange, which is made by any person; or

(iii) a publication which consists solely of a notice or report of a general meeting or proposed general meeting of the person making the offer, the issuer, the trustee of the business trust or any entity, a notice or report of a general meeting or proposed general meeting of the unit holders of the business trust, or a presentation of oral or written material on matters so contained in the notice or report at the general meeting;

“information memorandum” means a document—

- (a) purporting to describe—
 - (i) the units or derivatives of units in the business trust being offered; or
 - (ii) the business and affairs of any one or more of the following—
 - (A) the issuer;
 - (B) the person making the offer;
 - (C) the business trust;
 - (D) the trustee of the business trust; and

(b) purporting to have been prepared for delivery to and review by relevant persons and persons to whom an offer referred to in subsection (2) is to be made so as to assist them in making an investment decision in respect of the units or derivatives of units in the business trust being offered;

“relevant person” means—

- (a) an accredited investor;
- (b) a corporation the sole business of which is to hold investments and the entire share capital of which is owned by one or more individuals, each of whom is an accredited investor;

continued on next page

Box A1.1 continuation

- (c) a trustee of a trust the sole purpose of which is to hold investments and each beneficiary of which is an individual who is an accredited investor;
- (d) an officer or equivalent person of the person making the offer (such person being an entity) or a spouse, parent, brother, sister, son or daughter of that officer or equivalent person; or
- (e) a spouse, parent, brother, sister, son or daughter of the person making the offer (such person being an individual).

[1/2005]

(4) In the definition of “information memorandum” in subsection (3), the reference to the affairs of the issuer, the person making the offer, the trustee of the business trust or the business trust shall—

- (a) in the case where the issuer, the person making the offer or the trustee of the business trust is a corporation, be construed as including a reference to the matters referred to in section 2 (2);
- (b) in the case where the issuer, the person making the offer or the trustee of the business trust is not a corporation, be construed to refer to such matters as may be prescribed by the Authority; and
- (c) in the case of a business trust, be construed as referring to such matters as may be prescribed by the Authority.

[1/2005]

(5) Notwithstanding any requirement in section 99 or any regulation made thereunder that a person has to deal in securities for his own account with or through a person prescribed by the Authority so that he can qualify as an exempt person, a person who acquires units or derivatives of units in a business trust under section 282Y or this section for his own account shall be considered an exempt person even though he does not comply with that requirement.

[1/2005]

(6) The Authority may, by order published in the *Gazette*, specify an amount in substitution of any amount specified in subsection (2) (a).

[1/2005]

[SFA, s. 275]

Offer of securities acquired pursuant to section 282Y or 282Z

282ZA.—(1) Notwithstanding sections 282V, 282W, 282X (1) (d) and (e) and (3) (c) and 282ZB but subject to subsection (7), where units or derivatives of units in a business trust initially acquired pursuant to an offer made in reliance on an exemption under section 282Y or 282Z are sold within the period of 6 months from the date of the initial acquisition to any person other than—

- (a) an institutional investor;
 - (b) a relevant person as defined in section 282Z (3); or
 - (c) any person pursuant to an offer referred to in section 282Z (2),
- then Subdivision (2) of this Division shall apply to the offer resulting in that sale.

[1/2005]

(1A) The reference to the sale of derivatives of units in a business trust under subsection (1) shall, in a case where the derivatives of units initially acquired are derivatives of units with an attached right of conversion into units in the business trust, include a reference to the sale of the converted units.

(2) Where units or derivatives of units in a business trust initially acquired pursuant to an offer made in reliance on an exemption under section 282Y or 282Z are sold to—

- (a) an institutional investor;
- (b) a relevant person as defined in section 282Z (3); or
- (c) any person pursuant to an offer referred to in section 282Z (2),

Subdivision (2) of this Division shall not apply to the offer resulting in that sale.

[1/2005]

(3) Subject to subsection (7), securities of a corporation (other than a corporation that is an accredited investor)—

- (a) the sole business of which is to hold investments; and
 - (b) the entire share capital of which is owned by one or more individuals, each of whom is an accredited investor,
- shall not be transferred within 6 months after the corporation has acquired any units or derivatives of units in a business trust pursuant to an offer made in reliance on an exemption under section 282Z unless—
- (i) that transfer—
 - (A) is made only to institutional investors or relevant persons as defined in section 282Z (3); or
 - (B) arises from an offer referred to in section 282Z (2);
 - (ii) no consideration is or will be given for the transfer; or
 - ((iii)) the transfer is by operation of law.

[1/2005]

(4) Subject to subsection (7), where—

- (a) the sole purpose of a trust (other than a trust the trustee of which is an accredited investor) is to hold investments; and
 - (b) each beneficiary of the trust is an individual who is an accredited investor,
- the beneficiaries’ rights and interest (howsoever described) in the trust shall not be transferred within 6 months after units or derivatives of units in a business trust are acquired for the trust pursuant to an offer made in reliance on an exemption under section 282Z unless—

- (i) that transfer—
 - (A) is made only to institutional investors or relevant persons as defined in section 282Z (3); or
 - (B) arises from an offer that is made on terms that such rights or interest are acquired at a consideration of not less than \$200,000 (or its equivalent in a foreign currency) for each transaction, whether such amount is to be paid for in cash or by exchange of securities or other assets;

continued on next page

Box A1.1 continuation

- (ii) no consideration is or will be given for the transfer; or
- (iii) the transfer is by operation of law.

[1/2005]

(5) For the avoidance of doubt, the reference to beneficiaries in subsection (4) shall include a reference to unit holders of a business trust and participants of a collective investment scheme.

[1/2005]

(6) For the avoidance of doubt, where any units or derivatives of units in a business trust are acquired pursuant to an offer made in reliance on an exemption under section 282Y or 282Z, an offer to sell those units or derivatives of units may be made in reliance on an exemption under section 282X (1) (d) or (e) after 6 months have elapsed from the date of the first-mentioned offer.

[1/2005]

(7) Subsections (1), (3) and (4) shall not apply where the units or derivatives of units in the business trust acquired are of the same class as other units or derivatives of units in the business trust—

- (a) an offer of which has previously been made in or accompanied by a prospectus; and
- (b) which are listed for quotation on a securities exchange.

Offer of units converted from debentures

282ZAA.—(1) Notwithstanding sections 282V, 282W, 282X(1)(d) and (e) and (3)(c) and 282ZB, where—

(a) debentures with an attached right of conversion into units in a business trust are acquired pursuant to an offer made in reliance on an exemption under section 274 or 275; and

(b) the debentures are then converted into the units,

then Subdivision (2) shall apply to an offer resulting in a sale of any of the units if the sale takes place within 6 months from the date of acquisition of the debentures.

(2) Subsection (1) shall not apply to a sale of the units to—

- (a) an institutional investor;
- (b) a relevant person as defined in section 282Z(3); or
- (c) any person pursuant to an offer referred to in section 282Z(2).

(3) Subsection (1) shall not apply where the units in the business trust sold are of the same class as other units in the business trust—

- (a) an offer of which has previously been made in or accompanied by a prospectus; and
- (b) which are listed for quotation on a securities exchange.

Offer made using offer information statement

282ZB.—(1) Subject to subsection (2), Subdivision (2) of this Division (other than subsection (1) (a) of section 282C and section 282Q) shall not apply to an offer of units or derivatives of units in a business trust (not being such securities as may be prescribed by the Authority) issued by a trustee-manager acting in its capacity as trustee-manager of the business trust where units of the business trust which have been previously issued are listed for quotation on a securities exchange, whether by means of a rights issue or otherwise, if—

(a) in the case where derivatives of units in a business trust are being issued by the trustee-manager in its capacity as trustee-manager of the business trust, the units are those of that business trust;

(b) an offer information statement relating to the offer which complies with such form and content requirements as may be prescribed by the Authority is lodged with the Authority; and

(c) the offer is made in or accompanied by the offer information statement referred to in paragraph (b).

[1/2005]

(2) Subsection (1) shall apply to an offer of units or derivatives of units in a business trust referred to therein only for a period of 6 months from the date of lodgment of the offer information statement relating to that offer.

[1/2005]

(3) The Authority may, on the application of any person interested, modify the prescribed form and content of the offer information statement in such manner as is appropriate, subject to such conditions or restrictions as may be determined by the Authority.

[1/2005]

(4) Sections 282I, 282J, 282N, 282O and 282P shall apply in relation to an offer information statement referred to in subsection (1) as they apply in relation to a prospectus.

[1/2005]

(5) For the purposes of subsection (4)—

(a) a reference in section 282I or 282J to the registration of the prospectus shall be read as a reference to the lodgment of the offer information statement; and

(b) a reference in section 282N or 282O to any information or new circumstance required to be included in a prospectus under section 282F shall be read as a reference to any information prescribed under subsection (1) (b).

[1/2005]

(6) Where the written consent of an expert is required to be given under section 282I (as applied in relation to an offer information statement under subsection (4)), that written consent shall be lodged with the Authority at the same time as the lodgment of the statement.

[1/2005]

(7) Where the written consent of an issue manager or underwriter is required to be given under section 282J (as applied in relation to that statement under subsection (4)), that written consent shall be lodged with the Authority at the same time as the lodgment of the statement.

continued on next page

Box A1.1 continuation

[1/2005]

Making offer using automated teller machine or electronic means

282ZC.—(1) Subject to subsection (3) and such requirements as may be prescribed by the Authority, a person making an offer of units or derivatives of units in a business trust using—

(a) any automated teller machine; or

(b) such other electronic means as may be prescribed by the Authority,

is exempted from the requirement under section 282C (1) (b) (i) that the offer be made in or accompanied by a prospectus in respect of the offer or, where applicable, the requirement under section 282C (4) that the offer be made in or accompanied by a profile statement in respect of the offer.

[1/2005]

(2) For the avoidance of doubt, a prospectus which complies with all other requirements of section 282C (1) (b) (i) or, where applicable, a profile statement which complies with all other requirements of section 282C (4) must still be prepared and issued in respect of any offer referred to in subsection (1).

[1/2005]

(3) Subsection (1) shall not apply unless the automated teller machine or prescribed electronic means indicates to a prospective subscriber or buyer—

(a) how he can obtain, or arrange to receive, a copy of the prospectus or, where applicable, profile statement in respect of the offer; and

(b) that he should read the prospectus or, where applicable, profile statement before submitting his application,

before enabling him to submit any application to subscribe for or purchase units or derivatives of units in a business trust.

[1/2005]

Revocation of exemption

282ZD.—(1) Where the Authority considers that a person is contravening, or is likely to contravene, or has contravened any condition or restriction imposed under section 282X (7), or that it is necessary in the public interest or for the protection of investors, it may revoke any exemption under this Subdivision, subject to such conditions as it thinks fit.

[1/2005]

(2) The Authority may revoke an exemption under subsection (1) without giving the person affected by the revocation an opportunity to be heard, but the person may, within 14 days of the revocation, apply to the Authority for the revocation to be reviewed by the Authority, and the revocation shall remain in effect unless it is withdrawn by the Authority.

[1/2005]

(3) A revocation made under this section shall be final and conclusive and there shall be no appeal therefrom.

[1/2005]

[SFA, s. 281]

Transactions under exempted offers subject to Division 2 of Part XII of Companies Act and Part XII of this Act

282ZE. For the avoidance of doubt, it is hereby declared that in relation to any transaction carried out under an exempted offer under this Part, nothing in this Part shall limit or diminish any liability which any person may incur in respect of any relevant offence under Division 2 of Part XII of the Companies Act (Cap. 50) or Part XII of this Act or any penalty, award of compensation or punishment in respect of any such offence.

[1/2005]

[SFA, s. 282]

Subdivision (4)—Debentures

Applicability of provisions relating to prospectus requirements

282ZF. Division 1 of this Part shall apply, subject to such modifications and adaptations as may be prescribed, to an offer to subscribe for or purchase debentures or units of debentures (within the meaning of section 239 (1)) issued by a trustee of a trust on behalf of the trust and have effect accordingly.

[1/2005]

Division 2—Collective Investment Schemes

Subdivision (1)—Interpretation

Interpretation of this Division

283.—(1) In this Division, unless the context otherwise requires—

“control”, in relation to an entity, means the capacity of a person to determine the outcome of decisions on the financial and operating policies of the entity, having regard to—

(a) the influence which the person can, in practice, exert on the entity (as opposed to the rights which the person can exercise in the entity); and

(b) any practice or pattern of behaviour of the person affecting the financial or operating policies of the entity (even if such practice or pattern of behaviour involves a breach of an agreement or a breach of trust),

but does not include any capacity of a person to influence decisions on the financial and operating policies of the entity if such influence is required by law or under any contract or order of court to be exercised for the benefit of other persons;

“immediate family”, in relation to an individual, means the individual’s spouse, son, adopted son, step-son, daughter, adopted daughter, step-daughter, father, step-father, mother, step-mother, brother, step-brother, sister or step-sister;

“preliminary document” means a document which has been lodged with the Authority and is issued for the purpose of determining the appropriate issue or sale price of, and the number of, units in a collective investment scheme to be issued or sold and which contains the information required to be included in a prospectus as may be prescribed under section 296 (1) (a) (i), except for such information as may be prescribed by the Authority;

continued on next page

Box A1.1 continuation

“profile statement” means a profile statement referred to in section 296 (2);

“prospectus” means any prospectus, notice, circular, material, advertisement, publication or other document used to make an offer of units in a collective investment scheme or proposed collective investment scheme, but does not include—

(a) a profile statement; or

(b) any material, advertisement or publication which is authorised by section 300 (other than subsection (3));

“recognised securities exchange” means a corporation which has been declared by the Authority, by order published in the *Gazette*, to be a recognised securities exchange for the purposes of this Division;

“related party” means—

(a) in relation to an entity—

(i) a director or an equivalent person of the entity;

(ii) the chief executive officer or an equivalent person of the entity;

(iii) a person who controls the entity;

(iv) a related corporation;

(v) any other entity controlled by it;

(vi) any other entity controlled by the person referred to in sub-paragraph (iii); and

(vii) a related party of any individual referred to in sub-paragraph (i), (ii) or (iii); and

(b) in relation to an individual—

(i) his immediate family;

(ii) a trustee of any trust of which the individual or any member of the individual's immediate family is—

(A) a beneficiary; or

(B) where the trust is a discretionary trust, a discretionary object, when the trustee acts in that capacity; and

(iii) any corporation in which he and his immediate family (whether directly or indirectly) have interests in voting shares of an aggregate of not less than 30% of the total votes attached to all voting shares;

“replacement document” means a replacement prospectus or a replacement profile statement referred to in section 298 (1), as the case may be;

“supplementary document” means a supplementary prospectus or a supplementary profile statement referred to in section 298 (1), as the case may be;

“unit trust” means a collective investment scheme under which the property is held on trust for the participants.

[16/2003; 1/2005]

(2) For the purposes of this Division, a statement shall be deemed to be included in a prospectus or profile statement if it is contained in any report or memorandum appearing on the face thereof or by reference incorporated therein or issued therewith.

[1/2005]

(3) For the purposes of this Division, a person makes an offer of units in a collective investment scheme if, and only if, as principal—

(a) he makes (either personally or by an agent) an offer to any person in Singapore which upon acceptance would give rise to a contract for the issue or sale of those units by him or another person with whom he has made arrangements for that issue or sale; or

(b) he invites (either personally or by an agent) any person in Singapore to make an offer which upon acceptance would give rise to a contract for the issue or sale of those units by him or another person with whom he has made arrangements for that issue or sale.

[1/2005]

(4) In subsection (3), “sale” includes any disposal for valuable consideration.

[1/2005]

[Companies, s. 4]

Use of term “real estate investment trust”

283A.—(1) No person shall, when describing or referring to any arrangement the rights or interests of which are, will be or have been the subject of an offer or intended offer, use the term “real estate investment trust” or any of its derivatives in any language in the name or description or any representation of that arrangement, unless—

(a) the arrangement is authorised under section 286 or is one for which an application for authorisation has been made and has not been refused by the Authority under that section;

(b) the arrangement is recognised under section 287 or is one for which an application for recognition has been made and has not been refused by the Authority under that section; or

(c) the Authority has given its consent in writing to that person to use that term or derivative, or that person belongs to a class of persons declared by the Authority by order published in the *Gazette* as persons who may use such term or derivative.

[31/2004;1/2005]

(2) Any person who contravenes subsection (1) shall be guilty of an offence and shall be liable on conviction to a fine not exceeding \$150,000 or to imprisonment for a term not exceeding 2 years or to both and, in the case of a continuing offence, to a further fine not exceeding \$15,000 for every day or part thereof during which the offence continues after conviction.

[31/2004]

(3) For the avoidance of doubt, in subsection (1)—

(a) “offer” or “intended offer”, in relation to any rights or interests in an arrangement, includes an offer or intended offer in relation to any such rights or interests that have previously been issued; and

(b) “representation”, in relation to an arrangement, includes a representation of the arrangement in any bill head, letter paper, notice, advertisement,

continued on next page

Box A1.1 continuation

publication or writing, whether in electronic, print or other form.

[31/2004;1/2005]

Code on Collective Investment Schemes

284.—(1) For the more effective administration, supervision and control of collective investment schemes, the Authority shall, under section 321, issue a code, to be known as the Code on Collective Investment Schemes.

(2) The Authority may from time to time revise the Code on Collective Investment Schemes by deleting, amending or adding to the provisions thereof.

(3) The Code on Collective Investment Schemes shall be deemed not to be subsidiary legislation.

[HK CUTMF]

Authority may disapply this Division to certain offers and invitations

284A. Notwithstanding any provision to the contrary in this Division, where—

(a) an offer of units in a collective investment scheme is one to which (but for this section) both this Division and Division 1 apply; and

(b) the Authority has by order published in the Gazette declared that this Division shall not apply to that offer or a class of offers to which that offer belongs, then this Division does not apply to that offer.

[16/2003;1/2005]

Division not to apply to certain collective investment schemes which are business trusts

284B. This Division does not apply to an offer of units in a collective investment scheme, where—

(a) the collective investment scheme is also a registered business trust; or

(b) the collective investment scheme is also a business trust and the offer is made in reliance on an exemption under Subdivision (3) of Division 1A.

[1/2005]

Modification of provisions to certain offers

284C. The Authority may, if it thinks it necessary in the interest of the public or a section of the public or for the protection of investors, by regulations modify or adapt the provisions of this Division in their application to such offer of units in a collective investment scheme as may be prescribed, and the provisions of this Division shall apply to such offer subject to such modifications or adaptations.

Subdivision (2)—Authorisation and recognition

Requirement for authorisation or recognition

285.—(1) No person shall make an offer of units in a collective investment scheme if the collective investment scheme has not been authorised under section 286 or recognised under section 287.

[1/2005]

(2) Any person who contravenes subsection (1) shall be guilty of an offence and shall be liable on conviction to a fine not exceeding \$150,000 or to imprisonment for a term not exceeding 2 years or to both and, in the case of a continuing offence, to a further fine not exceeding \$15,000 for every day or part thereof during which the offence continues after conviction.

[UK FSMA 2000, s. 238]

Authorised schemes

286.—(1) The Authority may, upon an application made to it in such form and manner as may be prescribed and subject to subsection (2) and the conditions specified in subsection (3), authorise a collective investment scheme constituted in Singapore.

(2) The Authority may authorise, under subsection (1), a collective investment scheme which is constituted as a unit trust if and only if the Authority is satisfied that—

(a) there is a manager for the scheme which satisfies the requirements in subsection (3);

(b) there is a trustee for the scheme approved under section 289;

(c) there is a trust deed in respect of the scheme entered into by the manager and the trustee for the scheme that complies with prescribed requirements; and

(d) the scheme, the manager for the scheme and the trustee for the scheme comply with this Act and the Code on Collective Investment Schemes.

(3) It shall be a condition for the authorisation of a collective investment scheme under subsection (1) that—

(a) the manager of the scheme is—

(i) in the case of a collective investment scheme—

(A) that is a trust;

(B) that invests primarily in real estate and real estate-related assets specified by the Authority in the Code on Collective Investment Schemes; and

(C) all or any units of which are listed for quotation on a securities exchange, the holder of a capital markets services licence for real estate investment trust management; and

(ii) in all other cases, the holder of a capital markets services licence for fund management or a person exempted under section 99(1)(a), (b), (c) or (d) in respect of fund management; and

(b) the manager for the scheme is a fit and proper person, in the opinion of the Authority, and in considering if a person satisfies this requirement, the Authority may take into account any matter relating to—

(i) any person who is or will be employed by or associated with the manager;

(ii) any person exercising influence over the manager; or

(iii) any person exercising influence over a related corporation of the manager.

[16/2003]

continued on next page

Box A1.1 continuation

- (4) The Authority may authorise, under subsection (1), a collective investment scheme which is not constituted as a unit trust if and only if the Authority is satisfied that the scheme and the manager for the scheme comply with such requirements as may be prescribed.
- (5) Without prejudice to subsection (2), the Authority may refuse to authorise any collective investment scheme under subsection (1) where it appears to the Authority that it is not in the public interest to do so.
- (6) The Authority shall not refuse to authorise a collective investment scheme under subsection (1) without giving the person who made the application an opportunity to be heard, except that an opportunity to be heard need not be given if the refusal is on the ground that it is not in the public interest to authorise the collective investment scheme on the basis of any of the following circumstances:
- (a) the person making the offer (being an entity), the responsible person or the collective investment scheme itself, is in the course of being wound up or otherwise dissolved, whether in Singapore or elsewhere;
 - (b) the person making the offer (being an individual) is an undischarged bankrupt, whether in Singapore or elsewhere;
 - (c) a receiver, a receiver and manager or an equivalent person has been appointed, whether in Singapore or elsewhere, in relation to or in respect of any property of the person making the offer (being an entity), the responsible person or the collective investment scheme.
- [16/2003;1/2005]
- (7) The responsible person for a collective investment scheme may, within 30 days after he is notified that the Authority has refused to authorise that scheme under subsection (1), appeal to the Minister whose decision shall be final.
- [1/2005]
- (8) An application made under subsection (1) shall be accompanied by such information or record as the Authority may require.
- (9) The Authority may publish for public information, in such manner as it considers appropriate, particulars of any collective investment scheme authorised under subsection (1).
- (10) The responsible person for a collective investment scheme authorised under subsection (1) and the approved trustee for the scheme, to the extent applicable, shall ensure that the conditions and requirements set out in subsections (2), (3) and (4) as applicable to that scheme shall continue to be satisfied.
- (11) Notwithstanding subsection (10), a failure by any person to comply with the Code on Collective Investment Schemes shall not of itself render that person liable to criminal proceedings but such failure may, in any proceedings whether civil or criminal, be relied upon by any party to the proceedings as tending to establish or to negate any liability which is in question in the proceedings.
- (12) If any person fails to comply with the Code on Collective Investment Schemes, the Authority may, in addition to, or as an alternative to any action under section 288, take such other action as it deems fit.
- (13) The responsible person for a collective investment scheme which is authorised under subsection (1) shall furnish such information or record regarding the scheme as the Authority may, at any time, require for the proper administration of this Act.
- (14) Where the manager for a collective investment scheme which is constituted as a unit trust and authorised under subsection (1) fails to comply with this Act or the Code on Collective Investment Schemes, the Authority may direct the trustee for the scheme to remove that person and appoint a new manager for the scheme.
- (15) Any person who contravenes subsection (10) or (13) shall be guilty of an offence and shall be liable on conviction to a fine not exceeding \$100,000 and, in the case of a continuing offence, to a further fine not exceeding \$10,000 for every day or part thereof during which the offence continues after conviction.
- [UK FSMA 2000, s. 242, s. 243, s. 244, s. 245, s. 247 and s. 248; HK SF Bill, Clause 103]

Recognised schemes

- 287.**—(1) The Authority may, upon an application made to it in such form and manner as may be prescribed and subject to subsection (2) and the conditions specified in subsection (3), recognise a collective investment scheme constituted outside Singapore.
- (2) The Authority may recognise a collective investment scheme under subsection (1) if and only if the Authority is satisfied that—
- (a) the laws and practices of the jurisdictions under which the scheme is constituted and regulated affords to investors in Singapore protection at least equivalent to that provided to them by or under this Division in the case of comparable authorised schemes;
 - (b) *(Deleted by Act 1/2005)*
 - (c) there is a manager for the scheme which satisfies the requirements in subsection (3);
 - (d) there is a representative for the scheme for the functions set out in subsection (13) who is—
 - (i) an individual resident in Singapore; or
 - (ii) a company, or a foreign company registered under Division 2 of Part XI of the Companies Act (Cap. 50);
 - (e) the Authority has been furnished with information regarding—
 - (i) the name of the representative referred to in paragraph (d) and his address (where such representative is a corporation) or contact particulars (where such representative is an individual); and
 - (ii) such other information as the Authority may prescribe; and
 - (f) the scheme, the manager for the scheme and the trustee for the scheme, where applicable, comply with this Act and the Code on Collective Investment Schemes.
- [1/2005]
- (3) It shall be a condition for the recognition of a collective investment scheme under subsection (1) that the manager for the scheme is—
- (a) licensed or regulated in the jurisdiction of its principal place of business; and
 - (b) a fit and proper person, in the opinion of the Authority, and in considering if a person satisfies this requirement, the Authority may take into account any matter relating to—
 - (i) any person who is or will be employed by or associated with the manager;

continued on next page

Box A1.1 continuation

- (ii) any person exercising influence over the manager; or
- (iii) any person exercising influence over a related corporation of the manager.

[16/2003;1/2005]

(4) Without prejudice to subsection (2), the Authority may refuse to recognise any collective investment scheme under subsection (1) where it appears to the Authority that it is not in the public interest to do so.

(5) The Authority shall not refuse to recognise a collective investment scheme under subsection (1) without giving the person who made the application an opportunity to be heard, except that an opportunity to be heard need not be given if the refusal is on the ground that it is not in the public interest to recognise the collective investment scheme on the basis of any of the following circumstances:

- (a) the person making the offer (being an entity), the responsible person or the collective investment scheme itself, is in the course of being wound up or otherwise dissolved, whether in Singapore or elsewhere;
- (b) the person making the offer (being an individual) is an undischarged bankrupt, whether in Singapore or elsewhere;
- (c) a receiver, a receiver and manager or an equivalent person has been appointed, whether in Singapore or elsewhere, in relation to or in respect of any property of the person making the offer (being an entity), the responsible person or the collective investment scheme.

[16/2003;1/2005]

(6) The responsible person for a collective investment scheme may, within 30 days after he is notified that the Authority has refused to recognise that scheme under subsection (1), appeal to the Minister whose decision shall be final.

[1/2005]

(7) An application made under subsection (1) shall be accompanied by such information or record as the Authority may require.

(8) The Authority may publish for public information, in such manner as it considers appropriate, particulars of any collective investment scheme recognised under subsection (1).

(9) The responsible person for a collective investment scheme recognised under subsection (1) shall ensure that the conditions and requirements set out in subsections (2) and (3), as applicable to that scheme, shall continue to be satisfied.

(10) Notwithstanding subsection (9), a failure by any person to comply with the Code on Collective Investment Schemes shall not of itself render that person liable to criminal proceedings but may, in any proceedings whether civil or criminal, be relied upon by any party to the proceedings as tending to establish or to negate any liability which is in question in the proceedings.

(11) If any person fails to comply with the Code on Collective Investment Schemes, the Authority may in addition to, or as an alternative to any action under section 288, take such other action as it deems fit.

(12) The responsible person for a collective investment scheme which is recognised under subsection (1) shall furnish such information or record regarding the scheme as the Authority may, at any time, require for the proper administration of this Act.

(13) The representative for a collective investment scheme which is recognised under subsection (1) shall carry out, or procure the carrying out of the following functions:

(a) facilitate—

- (i) the issuing and redeeming of units in the scheme;
- (ii) the publishing of sale and purchase prices of units in the scheme;
- (iii) the sending of reports of the scheme to participants;
- (iv) the furnishing of such books relating to the sale and redemption of units as the Authority may require; and
- (v) the inspection of the instruments constituting the scheme;

(b) either maintain for inspection in Singapore a subsidiary register of participants who subscribed for or purchased their units in Singapore, or maintain in Singapore any facility that enables the inspection or extraction of the equivalent information;

(c) within 14 days after any change in the particulars referred to in subsection (2) (e), give notice in writing of such change to the Authority;

(d) furnish such information or record regarding the scheme as the Authority may, at any time, require for the proper administration of this Act; and

(e) such other functions as the Authority may prescribe.

(13A) In carrying out or procuring the carrying out of the functions referred to in subsection (13), the representative shall ensure that—

(a) for the purposes of subsection (13) (a) (ii), the sale and purchase prices of units in the collective investment scheme are published in the language of the prospectus;

(b) for the purposes of subsection (13) (a) (iii), the reports of the scheme sent to participants are prepared in the language of the prospectus, except in relation to any participant who has consented to being sent a report in a language other than the language of the prospectus;

(c) for the purposes of subsection (13) (a) (v), if the instruments constituting the scheme are not in the language of the prospectus, an accurate translation of the instruments in the language of the prospectus is made available to a participant for inspection, unless the participant has consented to the making available to him for inspection of the instruments in a language other than the language of the prospectus; and

(d) for the purposes of subsection (13) (b), if the subsidiary register of participants or equivalent information is not in the language of the prospectus, an accurate translation of the register or equivalent information in the language of the prospectus is made available to a participant for inspection or extraction, unless the participant has consented to the making available to him for inspection or extraction of the register or equivalent information in a language other than the language of the prospectus.

[16/2003]

(13B) In subsection (13A), “language of the prospectus” means the language of the prospectus accompanying or making the offer of units in the collective investment scheme.

[16/2003;1/2005]

(13C) Section 318A (2) shall not apply to the instruments constituting the scheme referred to in subsection (13) (a) (v) or to the subsidiary register of participants or equivalent information referred to in subsection (13) (b).

[16/2003]

continued on next page

Box A1.1 continuation

(14) Any person who contravenes subsection (9), (12) or (13) shall be guilty of an offence and shall be liable on conviction to a fine not exceeding \$100,000 and, in the case of a continuing offence, to a further fine not exceeding \$10,000 for every day or part thereof during which the offence continues after conviction.

[UK FSMA 2000, s. 272, s. 273, s. 274, s. 275 and s. 276; ASIC Policy Statement 65 (modified)]

Revocation, suspension or withdrawal of authorisation or recognition

288.—(1) The Authority may revoke the authorisation of a collective investment scheme granted under section 286 or the recognition of a collective investment scheme granted under section 287 if—

- (a) the application for authorisation or recognition, or any related information or record submitted to the Authority whether at the same time as or subsequent to the application, was false or misleading in a material particular or omitted a material particular which, had it been known to the Authority at the time of submission, would have resulted in the Authority not granting the authorisation or recognition;
- (aa) the Authority is of the opinion that the continued authorisation or recognition of the scheme is or will be against the public interest;
- (b) the Authority is of the opinion that the continued authorisation or recognition of the scheme is or will be prejudicial to its participants or potential participants; or
- (c) in the case of—
 - (i) a scheme authorised under section 286, the responsible person for the scheme or the trustee for the scheme, where applicable, fails to comply with section 286(10) or (13); or
 - (ii) a scheme recognised under section 287, the responsible person for the scheme or the representative for the scheme, where applicable, fails to comply with section 287(9), (12) or (13).

[16/2003]

(2) Where the Authority revokes the authorisation or recognition of a collective investment scheme under subsection (1), the Authority may issue such directions as it deems fit to the responsible person for the scheme, including a direction that he—

- (a) refund all moneys contributed by the participants of the scheme; or
- (b) provide the participants with an option, on such terms as the Authority may approve, to obtain from him a refund of all moneys contributed by them or to redeem their units in accordance with the scheme.

(3) In determining whether to issue a direction under subsection (2), the Authority shall consider whether the responsible person for the collective investment scheme is able to liquidate the property of the scheme without material adverse financial effect to the participants, and for this purpose, the factors which the Authority may take into account include—

- (a) whether a significant amount of the moneys contributed by the participants has been invested;
- (b) the liquidity of the property of the scheme; and
- (c) the penalties, if any, payable for liquidating the property.

(4) A responsible person who contravenes any of the directions issued by the Authority to him under subsection (2) shall be guilty of an offence and shall be liable on conviction to a fine not exceeding \$50,000 and, in the case of a continuing offence, to a further fine not exceeding \$5,000 for every day or part thereof during which the offence continues after conviction.

(5) Notwithstanding subsection (1), the Authority may, if it considers it desirable to do so, instead of revoking the authorisation or recognition of a collective investment scheme, suspend the authorisation or recognition of that scheme for a specific period, and may at any time remove such suspension.

(6) Where the Authority revokes the authorisation or recognition of a collective investment scheme under subsection (1) or suspends the authorisation or recognition of a collective investment scheme under subsection (5), it shall notify the responsible person for the scheme.

(7) Subject to subsection (8), the Authority may, upon an application in writing made to it by the responsible person for a collective investment scheme, in such form and manner as may be prescribed, withdraw the authorisation or recognition of that scheme.

(8) The Authority may refuse to withdraw the authorisation or recognition of a collective investment scheme under subsection (7) where the Authority is of the opinion that—

- (a) there is any matter concerning the scheme which should be investigated before the authorisation or recognition is withdrawn; or
- (b) the withdrawal of the authorisation or recognition would not be in the public interest.

(8A) The Authority shall not—

- (a) revoke the authorisation or recognition of a collective investment scheme under subsection (1);
- (b) suspend the authorisation or recognition of a collective investment scheme under subsection (5); or
- (c) refuse the withdrawal of the authorisation or recognition of a collective investment scheme under subsection (8), without giving the responsible person of the scheme an opportunity to be heard, except that an opportunity to be heard need not be given if the revocation or suspension is on the ground that the continued authorisation or recognition of the scheme is against the public interest on the basis of any of the following circumstances:

- (i) the person making the offer (being an entity), the responsible person or the collective investment scheme itself, is in the course of being wound up or otherwise dissolved, whether in Singapore or elsewhere;
- (ii) the person making the offer (being an individual) is an undischarged bankrupt, whether in Singapore or elsewhere;
- (iii) a receiver, a receiver and manager or an equivalent person has been appointed, whether in Singapore or elsewhere, in relation to or in respect of any property of the person making the offer (being an entity), the responsible person or the collective investment scheme.

[16/2003;1/2005]

(8B) The responsible person for a collective investment scheme may, within 30 days after he is notified that the Authority—

- (a) has revoked the authorisation or recognition, as the case may be, of that scheme under subsection (1);
- (b) has suspended the authorisation or recognition, as the case may be, of that scheme under subsection (5); or

continued on next page

Box A1.1 continuation

(c) has refused to withdraw the authorisation or recognition, as the case may be, of that scheme under subsection (8), appeal to the Minister whose decision shall be final.

[1/2005]

(9) Where the Authority revokes an authorisation or recognition under subsection (1), suspends an authorisation or recognition under subsection (5) or withdraws an authorisation or recognition under subsection (7), it may—

(a) impose such conditions on the revocation, suspension or withdrawal as it considers appropriate; and

(b) publish notice of the revocation, suspension or withdrawal, and the reason therefor, in such manner as it considers appropriate.

[UK FSMA 2000, s. 254, s. 255 and s. 256; HK SF Bill, Clause 105]

Approval of trustees

289.—(1) The Authority may, upon an application made to it in such form and manner as may be prescribed, approve a public company to act as a trustee for collective investment schemes which are authorised under section 286 and constituted as unit trusts (referred to in this Subdivision as an approved trustee).

(2) The Authority shall not approve a public company to act as trustee under subsection (1) unless the company satisfies such financial requirements and other criteria as the Authority may prescribe.

(3) An approved trustee shall continue to satisfy the financial requirements and other criteria prescribed under subsection (2).

(4) Where the Authority is of the opinion that an approved trustee—

(a) has failed to satisfy a financial requirement or other criterion prescribed under subsection (2);

(b) has not carried out its duties with due care and diligence;

(c) has acted in a manner which prejudices the participants of any authorised collective investment scheme; or

(d) has failed to comply with this Act or the Code on Collective Investment Schemes,

the Authority may—

(i) revoke an approval granted under this section and may direct the manager for the collective investment scheme or schemes which such approved trustee was acting for, to appoint a new trustee for the scheme or schemes;

(ii) prohibit such approved trustee from acting as trustee for any new collective investment scheme; or

(iii) issue such direction as it deems fit.

(5) An approved trustee shall comply with any direction issued to it under subsection (4).

(6) For the avoidance of doubt, a direction issued under subsection (4) shall be deemed not to be subsidiary legislation.

(7) Any approved trustee who contravenes subsection (3) or (5) shall be guilty of an offence and shall be liable on conviction to a fine not exceeding \$100,000 and, in the case of a continuing offence, to a further fine not exceeding \$10,000 for every day or part thereof during which the offence continues after conviction.

[HK CUTMF Chapter 4]

Inspection of approved trustees

290.—(1) The Authority may, from time to time, inspect the books of an approved trustee.

(2) For the purpose of an inspection under this section, the approved trustee under inspection shall afford the Authority access to, and shall produce, its books and shall give such information and facilities as may be required to conduct the inspection.

(3) The Authority shall have the power to copy or take possession of the books of an approved trustee under inspection.

(4) An approved trustee which fails, without reasonable excuse, to produce any book or furnish any information or facilities in accordance with subsection (2), or otherwise obstructs the Authority in the exercise of its powers under this section, shall be guilty of an offence and shall be liable on conviction to a fine not exceeding \$50,000.

[SIA, s. 12]

Duty of trustees to furnish Authority with such return and information as Authority requires

291. An approved trustee shall furnish such returns and provide such information relating to its business as the Authority may require.

[SIA, s. 67]

Liability of trustees

292.—(1) Subject to subsection (2), any provision in a trust deed required under section 286(2)(c) or in any contract with the participants of a collective investment scheme to which such a trust deed relates, shall be void in so far as it would have the effect of exempting a trustee under the trust deed from, or indemnifying a trustee against, liability for breach of trust where the trustee fails to exercise the degree of care and diligence required of a trustee.

(2) Subsection (1) shall not invalidate—

(a) any release otherwise validly given in respect of anything done or omitted to be done by a trustee before the giving of the release; or

(b) any provision enabling such a release to be given—

(i) on the agreement thereto of a majority of not less than three-fourths of the participants in a collective investment scheme voting in person or by proxy at a meeting summoned for the purpose; and

(ii) either with respect to specific acts or omissions or on the trustee ceasing to act.

[Companies, s. 120]

Authority may issue directions

continued on next page

Box A1.1 continuation

293.—(1) The Authority may, where it appears to the Authority to be necessary or expedient in the public interest to do so, issue directions by notice in writing either of a general or specific nature to—

- (a) where a collective investment scheme is constituted as a corporation, the corporation;
- (b) the manager, trustee, or representative for a collective investment scheme; or
- (c) any class of such persons referred to in paragraph (a) or (b).

(2) Any person to whom a notice is given under subsection (1) shall comply with such direction as may be contained in the notice.

(3) For the avoidance of doubt, a direction issued under subsection (1) shall be deemed not to be subsidiary legislation.

(4) Any person who contravenes any of the directions issued to him under subsection (1) shall be guilty of an offence and shall be liable on conviction to a fine not exceeding \$50,000 and, in the case of a continuing offence, to a further fine not exceeding \$5,000 for every day or part thereof during which the offence continues after conviction.

[SIA, s. 21]

Service

294.—(1) Where a collective investment scheme—

(a) is authorised under section 286, any document relating to the scheme shall be sufficiently served if served on the responsible person for the scheme at his last known address; or

(b) is recognised under section 287, any document relating to the scheme shall be sufficiently served if served on the responsible person for the scheme or the representative for the scheme at his last known address.

(1A) For the avoidance of doubt, a reference in subsection (1) to service of any document relating to the scheme shall include the service of any process in relation to the scheme.

[1/2005]

(2) Any notice or direction to be given or served by the Authority on a corporation (where a collective investment scheme is constituted as a corporation), the manager for a collective investment scheme, the trustee for a collective investment scheme or the representative for a collective investment scheme shall for all purposes be regarded as duly given or served if it has been delivered or sent by post or facsimile transmission to such person at his last known address.

(3) In the case of a corporation, the last known address referred to in subsections (1) and (2) shall be—

- (a) if it is a company incorporated in Singapore, the address of its registered office in Singapore; or
- (b) if it is a foreign company, the address of its registered office in Singapore or the registered address of its agent or, if it does not maintain a place of business in Singapore, its registered office in the place of its incorporation.

[Companies, s. 376]

Winding up

295.—(1) Where a collective investment scheme is to be wound up, whether under this section or otherwise, the responsible person for the scheme shall give notice in writing of the proposed winding up to the Authority at least 7 days before the winding up.

(2) Where the Authority revokes or withdraws the authorisation of a collective investment scheme under section 288, the responsible person and, where applicable, the trustee shall take the necessary steps to wind up the scheme.

(3) Where—

- (a) the responsible person for a collective investment scheme authorised under section 286 is in liquidation; or
 - (b) in the opinion of the trustee for a collective investment scheme authorised under section 286 which is constituted as a unit trust, the responsible person for the scheme has ceased to carry on business or has, to the prejudice of the participants of the scheme, failed to comply with any provision of the trust deed in respect of the scheme,
- the trustee shall summon a meeting of the participants for the purpose of determining an appropriate course of action.

(4) A meeting under subsection (3) shall be summoned—

- (a) by giving notice in writing of the proposed meeting at least 21 days before the proposed meeting to each participant at his last known address or, in the case of joint participants, to the participant whose name stands first in the records of the responsible person for the scheme; and
- (b) by publishing, at least 21 days before the proposed meeting, an advertisement giving notice of the meeting in at least 4 local daily newspapers, one each published in the English, Malay, Chinese and Tamil languages.

(5) If at any such meeting a resolution is passed by a majority in number representing three-fourths in value of the participants present and voting either in person or by proxy at the meeting that the scheme to which the trust deed relates be wound up, the responsible person for the scheme and, where applicable, the trustee shall take the necessary steps to wind up the scheme.

(6) Any responsible person who contravenes subsection (1) shall be guilty of an offence and shall be liable on conviction to a fine not exceeding \$50,000.

(7) Any responsible person or, where applicable, trustee who contravenes subsection (2) or (5) shall be guilty of an offence and shall be liable on conviction to a fine not exceeding \$50,000.

(8) Any trustee who contravenes subsection (3) or (4) shall be guilty of an offence and shall be liable on conviction to a fine not exceeding \$50,000.

[Companies, s. 118]

Power to acquire units of participants of real estate investment trust in certain circumstances

295A.—(1) Where an arrangement or a contract involving the transfer of all of the units, or all of the units in any particular class, in a real estate investment trust (referred to in this section as the subject trust), to—

- (a) the trustee of another trust (including the trustee-manager of a business trust and the trustee of another real estate investment trust); or

continued on next page

Box A1.1 continuation

- (b) a corporation,
referred to in this section as the transferee has, within 4 months after the making of the offer in that behalf by the transferee, been approved as to the units or as to each class of units whose transfer is involved by participants of the subject trust holding no less than 90% of the total number of those units or of the units of that class (other than units already held at the date of the offer by the transferee), the transferee may, at any time within 2 months after the offer has been so approved, give notice in the prescribed manner to any dissenting participant of the subject trust that it desires to acquire his units.
- (2) When a notice referred to in subsection (1) is given, the transferee shall, unless on an application made by a dissenting participant within one month from the date on which the notice was given or within 14 days of a statement being supplied to a dissenting participant under subsection (3) (whichever is the later) a court thinks fit to order otherwise, be entitled and bound to acquire those units—
- (a) on the terms which under the arrangement or contract the units of the approving participants are to be transferred to the transferee; or
(b) if the offer contained 2 or more alternative sets of terms, on the terms which were specified in the offer as being applicable to dissenting participants.
- (3) Where a transferee has given notice to any dissenting participant of the subject trust that it desires to acquire his units, the dissenting participant shall be entitled to require the transferee by a demand in writing served on the transferee, within one month from the date on which the notice was given, to supply him with a statement in writing of the names and addresses of all other dissenting participants as shown in the register of participants of the subject trust; and the transferee shall not be entitled or bound to acquire the units of the dissenting participants until 14 days after the posting of the statement of such names and addresses to the dissenting participant.
- (4) Where, pursuant to any such arrangement or contract, units in the subject trust are transferred to the transferee or its nominee and those units together with any other units in the subject trust held by the transferee at the date of the transfer comprise or include 90% of the total number of the units in the subject trust or of any class of those units, then—
- (a) the transferee shall within one month from the date of the transfer (unless on a previous transfer pursuant to the arrangement or contract it has already complied with this requirement) give notice of that fact in the prescribed manner to the participants of the subject trust holding the remaining units in, or the remaining units of that class of units in, the subject trust who have not assented to the arrangement or contract; and
(b) any such participant may within 3 months from receiving the notice require the transferee to acquire his units.
- (5) Where a participant has given notice under subsection (4)(b) with respect to any units, the transferee shall be entitled and bound to acquire those units—
- (a) on the terms on which under the arrangement or contract the units of the approving participants were transferred to it; or
(b) on such other terms as are agreed or as the court on the application of either the transferee or the participant thinks fit to order.
- (6) Where a notice has been given by the transferee under subsection (1) and a court has not, on an application made by the dissenting participant, ordered to the contrary, the transferee shall—
- (a) after the expiration of one month after the date on which the notice has been given;
(b) after 14 days after a statement has been supplied to a dissenting participant under subsection (3); or
(c) if an application to the court by the dissenting participant is then pending, after that application has been disposed of,
transmit a copy of the notice to the trustee of the subject trust together with an instrument of transfer executed on behalf of the participant by any person appointed by the transferee and on its own behalf by the transferee, and pay, allot or transfer to the trustee of the subject trust the amount or other consideration representing the price payable by the transferee for the units which by virtue of this section the transferee is entitled to acquire, and the trustee of the subject trust shall thereupon register the transferee as the holder of those units.
- (7) Any sums received by the trustee of the subject trust under this section shall be paid into a separate bank account, and any such sums and any other consideration so received shall be held by that trustee in trust for the several persons who had held the units in respect of which they were respectively received.
- (8) Where any consideration other than cash is held in trust by the trustee of the subject trust for any person under this section, the trustee may, after the expiration of 2 years from, and shall, before the expiration of 10 years from, the date on which such consideration was allotted or transferred to him, transfer such consideration to the Official Receiver.
- (9) The Official Receiver shall sell or dispose of any consideration so received in such manner as he thinks fit and shall deal with the proceeds of such sale or disposal in accordance with section 295B.
- (10) In determining the units in the subject trust already held by the transferee at the date of the offer under subsection (1) or the percentage of the total number of units in the subject trust or of any class of those units held by the transferee under subsection (4), units held or acquired—
- (a) by a nominee on behalf of the transferee;
(b) where the transferee is a corporation, by its related corporation or by a nominee of the related corporation;
(c) where the transferee is the trustee-manager of a business trust or the trustee of a real estate investment trust—
(i) by a person who controls more than 50% of the voting power in the business trust or real estate investment trust, or by a nominee of that person;
(ii) by the trustee-manager of the business trust on its own account, or by the manager for the real estate investment trust, or by a nominee of the trustee-manager or manager; or
(iii) by a related corporation of the trustee-manager for the business trust or the manager for the real estate investment trust or by a nominee of that related corporation; or/P>
(d) where the transferee is the trustee of a trust that is not a business trust or real estate investment trust, by a related corporation of the trustee (being a corporation) or by a nominee of that related corporation,
shall be treated as held or acquired by the transferee.
- (11) For the avoidance of doubt, in this section—
- (a) a reference to a transferee (being the trustee of a trust) holding, acquiring or contracting to acquire units in another trust is a reference to his doing any of these as trustee of the first-mentioned trust; and
(b) a reference to a transfer of units of a trust to a transferee (being the trustee of another trust) is a reference to such transfer of units to him as trustee

continued on next page

Box A1.1 continuation

of that other trust.

(12) The reference in subsection(1) to units already held by the transferee—

(a) includes a reference to units which the transferee has contracted to acquire; but

(b) excludes units which are the subject of a contract binding the holder thereof to accept the offer when it is made, being a contract entered into by the holder for no consideration and under seal or for no consideration other than a promise by the transferee to make the offer.

(13) Where, during the period within which an offer for the transfer of units to the transferee can be approved, the transferee acquires or contracts to acquire any of the units whose transfer is involved but otherwise than by virtue of the approval of the offer, then the transferee may be treated for the purposes of this section as having acquired or contracted to acquire those units by virtue of the approval of the offer if, and only if—

(a) the consideration for which the units are acquired or contracted to be acquired (referred to in this subsection as the acquisition consideration) does not at that time exceed the consideration specified in the terms of the offer; or

(b) those terms are subsequently revised so that when the revision is announced the acquisition consideration, at the time referred to in paragraph (a), no longer exceeds the consideration specified in those terms.

(14) In this section and sections 295B and 295C—

“dissenting participant” includes a participant who has not assented to the arrangement or contract and any participant who has failed or refused to transfer his units to the transferee in accordance with the arrangement or contract;

“Official Receiver” means the Official Assignee appointed under the Bankruptcy Act (Cap. 20) and includes his deputy and any person appointed as Assistant Official Assignee;

“real estate investment trust” means a collective investment scheme that is—

(a) authorised under section 286 or recognised under section 287; and

(b) a trust that invests primarily in real estate and real estate-related assets specified by the Authority in the Code on Collective Investment Schemes and all or any of the units of which are listed for quotation on a securities exchange.

Unclaimed money to be paid to Official Receiver

295B.—(1) The Official Receiver who receives moneys arising from the proceeds of a sale or disposal under section 295A shall place the moneys to the credit of a separate account to be entitled the Compulsory Acquisition of Scheme Account.

(2) The interest arising from the investment of the moneys standing to the credit of the Compulsory Acquisition of Scheme Account shall be paid into the Consolidated Fund.

(3) If any person makes any demand for any money placed to the credit of the Compulsory Acquisition of Scheme Account, the Official Receiver, upon being satisfied that that person is entitled to the money, shall authorise payment thereof to be made to him out of that Account or, if it has been paid into the Consolidated Fund, may authorise payment of a like amount to be made to him out of moneys made available by Parliament for the purpose.

(4) Any person dissatisfied with the decision of the Official Receiver in respect of a claim made pursuant to subsection (3) may appeal to a court which may confirm, disallow or vary the decision.

(5) Where any unclaimed moneys paid to a person pursuant to subsection (3) are afterwards claimed by any other person, that other person shall not be entitled to any payment out of the Compulsory Acquisition of Scheme Account or out of the Consolidated Fund but such other person may have recourse against the first-mentioned person to whom the unclaimed moneys have been paid.

(6) Any unclaimed moneys paid to the credit of the Compulsory Acquisition of Scheme Account to the extent to which the unclaimed moneys have not been under this section paid out of that Account shall, upon the lapse of 7 years from the date of the payment of the moneys to the credit of that Account, be paid into the Consolidated Fund.

Remedies in cases of oppression or injustice

295C.—(1) Any participant of a real estate investment trust may apply to a court for an order under this section on the ground—

(a) that the affairs of the trust are being conducted by the manager or trustee for the trust, or the powers of the directors of the manager or directors of the trustee for the trust are being exercised, in a manner oppressive to one or more of the participants of the trust including himself or in disregard of his or their interests as participants of the trust; or

(b) that some act of the manager or trustee for the trust, carried out in its capacity as manager or trustee for the trust, as the case may be, has been done or is threatened or that some resolution of the participants of the trust or any class of them has been passed or is proposed which unfairly discriminates against or is otherwise prejudicial to one or more of the participants of the trust including himself.

(2) If on such application the court is of the opinion that either of the grounds referred to in subsection (1) is established, the court may, with a view to bringing to an end to or remedying the matters complained of, make such order as it thinks fit and, without prejudice to the generality of the foregoing, the order may—

(a) direct or prohibit any act or cancel or vary any transaction or resolution;

(b) regulate the conduct of the affairs of the manager or trustee for the trust in relation to the trust in future;

(c) authorise civil proceedings against the directors of the manager or directors of the trustee for the trust to be brought in the name of or on behalf of all the participants of the trust as a whole by such person or persons and on such terms as the court may direct;

(d) provide for the purchase of the units in the trust by other participants of the trust;

(e) provide that the trust be wound up; or

(f) provide that the costs and expenses of and incidental to the application for the order are to be raised and paid out of the property of the trust or to be borne and paid in such manner and by such persons as the court deems fit.

(3) Where an order under this section makes any alteration in or addition to the trust deed of any trust, then, notwithstanding anything in any other provision of this Act but subject to the provisions of the order, the manager or trustee of the trust concerned shall not have power, without the leave of the court, to make any further alteration in or addition to the trust deed that is inconsistent with the provisions of the order; but subject to the foregoing

continued on next page

Box A1.1 continuation

provisions of this subsection the alterations or additions made by the order shall have the same effect as if duly made by special resolution of the participants of the trust

(4) A copy of any order made under this section shall be lodged by the applicant with the Authority within 7 days after the making of the order.

(5) Any person who contravenes subsection (4) shall be guilty of an offence and shall be liable on conviction to a fine not exceeding \$10,000 and, in the case of a continuing offence, to a further fine not exceeding \$1,000 for every day or part thereof during which the offence continues after conviction.

(6) This section shall apply to a person who is not a participant of a trust but to whom units in the trust have been transmitted by operation of law as it applies to the participants of a trust; and references to a participant or participants shall be construed accordingly.

Subdivision (3)—Prospectus requirements

Requirement for prospectus and profile statement, where relevant

296.—(1) No person shall make an offer of units in a collective investment scheme unless the offer—

(a) is made in or accompanied by a prospectus in respect of the offer—

(i) that is prepared in accordance with such requirements as may be prescribed by the Authority;

(ii) a copy of which, being one that has been signed in accordance with subsection (2A), is lodged with the Authority; and

(iii) that is registered by the Authority; and

(b) complies with such requirements as may be prescribed by the Authority.

[1/2005]

(1A) A person who lodges a preliminary document with the Authority shall be deemed to have lodged a prospectus with the Authority.

[1/2005]

(1B) A preliminary document referred to in subsection (1A) shall contain all information to be included in a prospectus other than such information as may be prescribed by the Authority.

[1/2005]

(2) Notwithstanding subsection (1), an offer of units in a collective investment scheme may be made in or accompanied by an extract from, or an abridged version of, a prospectus (referred to in this Subdivision as a profile statement), instead of a prospectus, if—

(a) a prospectus is prepared in accordance with such requirements as may be prescribed under subsection (1) (a) (i) and the profile statement is prepared in accordance with such requirements as may be prescribed;

(b) a copy of the prospectus and a copy of the profile statement, each of which has been signed in accordance with subsection (2A), are lodged with the Authority, and the prospectus is lodged no later than the profile statement;

(c) the prospectus and profile statement are registered by the Authority;

(d) sufficient copies of the prospectus are made available for collection at the times and places specified in the profile statement; and

(e) the offer complies with such other requirements as may be prescribed.

[1/2005]

(2A) The copy of a prospectus or profile statement lodged with the Authority shall be signed—

(a) where the person making the offer of units in a collective investment scheme is the responsible person for the scheme, by every director or equivalent person of the responsible person and every person who is named therein as a proposed director or an equivalent person of the responsible person; and

(b) where the person making the offer of units in a collective investment scheme is not the responsible person for the scheme—

(i) where the responsible person is controlled by—

(A) the person making the offer;

(B) one or more of the related parties of the person making the offer; or

(C) the person making the offer and one or more of his related parties,

by the persons referred to in paragraph (a) and the persons referred to in sub-paragraph (ii) (A) or (B), as the case may be; and

(ii) in any other case—

(A) where that person is an entity, by every director or equivalent person of that entity; or

(B) where that person is an individual, by the individual or a person authorised by him in writing.

[1/2005]

(2B) A requirement under subsection (2A) for the copy of a prospectus or profile statement to be signed by a director or an equivalent person is satisfied if the copy is signed—

(a) by that director or equivalent person; or

(b) by a person who is authorised in writing by that director or equivalent person to sign on his behalf.

[1/2005]

(2C) A requirement under subsection (2A) for the copy of a prospectus or profile statement to be signed by a person named therein as a proposed director or an equivalent person is satisfied if the copy is signed—

(a) by that proposed director or equivalent person; or

(b) by a person who is authorised in writing by that proposed director or equivalent person to sign on his behalf.

[1/2005]

(3) No person shall make an offer of units in a collective investment scheme if that scheme has not been formed or does not exist.

[1/2005]

(4) *(Deleted by Act 1/2005)*

(5) Any person who contravenes subsection (1) or (3) shall be guilty of an offence and shall be liable on conviction to a fine not exceeding \$150,000 or to imprisonment for a term not exceeding 2 years or to both and, in the case of a continuing offence, to a further fine not exceeding \$15,000 for every day or part thereof during which the offence continues after conviction.

continued on next page

Box A1.1 continuation

(6) The Authority may register a prospectus or a profile statement on any day within the period prescribed by the Authority from the date of lodgment thereof with the Authority, unless—

- (a) the Authority gives to the person making the offer a notice of an opportunity to be heard under subsection (12);
- (b) the Authority gives a notice to the person making the offer of an extension, in which case, the Authority may, not later than 28 days from the date of lodgment of the prospectus or profile statement—
 - (i) register the prospectus or profile statement; or
 - (ii) give the person making the offer a notice of an opportunity to be heard under subsection (12);
- (c) the person making the offer applies in writing to extend the period during which the prospectus or profile statement may be registered, in which case the Authority may, at any time up to and including the date on which the extended period ends—
 - (i) register the prospectus or profile statement; or
 - (ii) give the person making the offer a notice of an opportunity to be heard under subsection (12); or
- (d) the person making the offer gives a notice in writing to the Authority to withdraw the lodgment of the prospectus or profile statement, in which case the Authority shall not register the prospectus or profile statement.

[1/2005]

(6A) Where, after a notice of an opportunity to be heard has been given under subsection (6)(a), (b)(ii) or (c)(ii), the Authority decides not to refuse registration of the prospectus or profile statement, the Authority may proceed with the registration on such date as it considers appropriate, except that that date shall not be earlier than such day from the date of lodgment of the prospectus or profile statement with the Authority as the Authority may prescribe.

[1/2005]

(6AA) For the purposes of subsections (6) and (6A), the Authority may prescribe the same period and day for all offers or different periods and days for different offers.

(6B) Where a prospectus lodged with the Authority is a preliminary document, the Authority shall not register the prospectus unless a copy of the prospectus which has been signed in accordance with subsection (2A) and which contains the information required to be included in a prospectus as prescribed under subsection (1) (a) (i), including such information which could be omitted from the preliminary document by virtue of subsection (1B), has been lodged with the Authority.

[1/2005]

(6C) A person making an offer of units in a collective investment scheme may lodge any amendment to a prospectus or profile statement in respect of that offer at any time before, but not after, the registration of the prospectus or profile statement by the Authority.

[1/2005]

(7) Subject to subsection (8)—

- (a) where any amendment to a prospectus is lodged, the prospectus and any profile statement which is lodged shall be deemed for the purposes of subsection (6) to have been lodged when such amendment was lodged; and
- (b) where any amendment to a profile statement is lodged, the profile statement shall be deemed for the purposes of subsection (6) to have been lodged when such amendment was lodged.

[16/2003;1/2005]

(8) Where an amendment to a prospectus or profile statement is lodged with the consent of the Authority, the prospectus or profile statement as amended shall be deemed, for the purposes of subsection (6), to have been lodged when the original prospectus or profile statement was lodged with the Authority.

[1/2005]

(8A) An amendment to a prospectus or profile statement that is lodged shall be treated as part of the original prospectus or profile statement.

[16/2003]

(9) The Authority may, for public information, publish—

- (a) a prospectus or profile statement lodged with the Authority under this section; and
- (b) where applicable, the translation thereof in the English language lodged with the Authority under section 318A (1), and for the purposes of this subsection, the person making the offer shall provide the Authority with a copy of the prospectus or profile statement and, where applicable, the translation in such form or medium for publication as the Authority may require.

[16/2003;1/2005]

(10) The Authority shall refuse to register a prospectus if—

- (a) the Authority is of the opinion that the prospectus contains a false or misleading statement;
- (b) there is an omission from the prospectus of any information that is required to be included, or an inclusion in the prospectus of any information that is prohibited, by virtue of requirements prescribed under subsection (1) (a);
- (c) the Authority is of the opinion that the prospectus does not comply with the requirements of this Act;
- (d) the copy of the prospectus that is lodged with the Authority is not signed in accordance with subsection (2A);
- (e) any written consent of an expert to the issue of the prospectus required under section 249 (as applied to this Subdivision by virtue of section 302), or a copy thereof which is verified as prescribed, is not lodged with the Authority;
- (ea) any written consent of an issue manager to the issue of the prospectus required under section 249A (1) (as applied to this Subdivision by virtue of section 302), or a copy thereof which is verified as prescribed, is not lodged with the Authority;
- (eb) any written consent of an underwriter to the issue of the prospectus required under section 249A (2) (as applied to this Subdivision by virtue of section 302), or a copy thereof which is verified as prescribed, is not lodged with the Authority; or
- (f) the Authority is of the opinion that it is not in the public interest to do so.

[1/2005]

continued on next page

Box A1.1 continuation

(11) The Authority shall refuse to register a profile statement if—

- (a) the Authority is of the opinion that the profile statement contains a false or misleading statement;
- (b) there is an omission from the profile statement of any information that is required to be included, or an inclusion in the profile statement of any information that is prohibited, by virtue of requirements prescribed under subsection (2) (a);
- (c) the copy of the profile statement that is lodged with the Authority is not signed in accordance with subsection (2A);
- (ca) any written consent of an expert to the issue of the profile statement required under section 249 (as applied to this Subdivision by virtue of section 302), or a copy thereof which is verified as prescribed, is not lodged with the Authority;
- (cb) any written consent of an issue manager to the issue of the profile statement required under section 249A (1) (as applied to this Subdivision by virtue of section 302), or a copy thereof which is verified as prescribed, is not lodged with the Authority;
- (cc) any written consent of an underwriter to the issue of the profile statement required under section 249A (2) (as applied to this Subdivision by virtue of section 302), or a copy thereof which is verified as prescribed, is not lodged with the Authority;
- (d) the Authority is of the opinion that the profile statement does not comply with the requirements of this Act;
- (e) the prospectus has not been registered by the Authority; or
- (f) the Authority is of the opinion that it is not in the public interest to do so.

[1/2005]

(12) The Authority shall not refuse to register a prospectus under subsection (10) or a profile statement under subsection (11) without giving the person making the offer an opportunity to be heard, except that an opportunity to be heard need not be given if the refusal is on the ground that it is not in the public interest to register the prospectus or profile statement on the basis of any of the following circumstances:

- (a) the person making the offer (being an entity), the responsible person or the collective investment scheme itself, is in the course of being wound up or otherwise dissolved, whether in Singapore or elsewhere;
- (b) the person making the offer (being an individual) is an undischarged bankrupt, whether in Singapore or elsewhere;
- (c) a receiver, a receiver and manager or an equivalent person has been appointed, whether in Singapore or elsewhere, in relation to or in respect of any property of the person making the offer (being an entity), the responsible person or the collective investment scheme.

[1/2005]

(13) Any person making an offer may, within 30 days after he is notified that the Authority has refused to register a prospectus or profile statement to which his offer relates under subsection (10) or (11), appeal to the Minister whose decision shall be final.

[1/2005]

(14) If—

- (a) a prospectus or profile statement is issued, circulated or distributed before it has been registered by the Authority; or
 - (b) an application to subscribe for or purchase units in a collective investment scheme is accepted, or units in a collective investment scheme are issued or sold, before a prospectus and, where applicable, profile statement, in respect of the units has been registered by the Authority,
- the person making the offer and every person who is knowingly a party to—
- (i) the issue, circulation or distribution of the prospectus or profile statement;
 - (ii) the acceptance of the application to subscribe for or purchase the units; or
 - (iii) the issue or sale of the units,

as the case may be, shall be guilty of an offence and shall be liable on conviction to a fine not exceeding \$150,000 or to imprisonment for a term not exceeding 2 years or to both and, in the case of a continuing offence, to a further fine not exceeding \$15,000 for every day or part thereof during which the offence continues after conviction.

[1/2005]

(14A) For the purposes of subsections (10) (a) and (11) (a), any reference to a statement shall include a reference to any information presented, regardless of whether such information is in text or otherwise.

[1/2005]

(15) Regulations made under this section may provide that a contravention of specified provisions thereof shall be an offence and may provide for penalties not exceeding a fine of \$50,000.

[Companies, s. 43; Aust. Corporations 2001, s. 721]

Stop order for prospectus and profile statement

297.—(1) If a prospectus has been registered and—

- (a) the Authority is of the opinion that the prospectus contains a false or misleading statement;
 - (b) there is an omission from the prospectus of any information that is required to be included, or an inclusion in the prospectus of any information that is prohibited, by virtue of requirements prescribed under section 296;
 - (c) the Authority is of the opinion that the prospectus does not comply with the requirements of this Act; or
 - (d) the Authority is of the opinion that it is in the public interest to do so,
- the Authority may by an order in writing (referred to in this section as a stop order) served on the person making the offer of units in a collective investment scheme to which the prospectus relates, direct that no or no further units in the scheme be issued or sold.

[16/2003;1/2005]

(2) If a profile statement has been registered and—

- (a) the Authority is of the opinion that the profile statement contains a false or misleading statement;
- (b) there is an omission from the profile statement of any information that is required to be included, or an inclusion in the profile statement of any information that is prohibited, by virtue of requirements prescribed under section 296;
- (c) the Authority is of the opinion that the profile statement does not comply with the requirements of this Act; or

continued on next page

Box A1.1 continuation

(d) the Authority is of the opinion that it is in the public interest to do so, the Authority may by an order in writing (referred to in this section as a stop order) served on the person making the offer of units in a collective investment scheme to which the profile statement relates, direct that no or no further units in the scheme be issued or sold.

[16/2003;1/2005]

(2A) Notwithstanding subsections (1) and (2), the Authority shall not serve a stop order if any of the units in a collective investment scheme to which the prospectus or profile statement relates has been issued or sold, and listed for quotation on a securities exchange and trading in them has commenced.

[1/2005]

(3) The Authority shall not serve a stop order under subsection (1) or (2) without giving the person making the offer of units in the collective investment scheme an opportunity to be heard, except that an opportunity to be heard need not be given if the stop order is served on the ground that it is in the public interest to do so on the basis of any of the following circumstances:

(a) the person making the offer (being an entity), the responsible person or the collective investment scheme itself, is in the course of being wound up or otherwise dissolved, whether in Singapore or elsewhere;

(b) the person making the offer (being an individual) is an undischarged bankrupt, whether in Singapore or elsewhere;

(c) a receiver, a receiver and manager or an equivalent person has been appointed, whether in Singapore or elsewhere, in relation to or in respect of any property of the person making the offer (being an entity), the responsible person or the collective investment scheme.

[16/2003;1/2005]

(4) Where applications for units in a collective investment scheme have been made prior to the service of a stop order, and—

(a) the contributions of the applicants to the scheme have not yet been invested in accordance with the scheme—

(i) where units in the scheme have not been issued to the applicants, the applications shall be deemed to have been withdrawn and cancelled; or

(ii) where units in the scheme have been issued to the applicants, the issue of the units shall be deemed to be void,

and the person making the offer of units in the scheme shall, within 7 days from the date of the stop order, pay to the applicants all moneys which the applicants have paid for the units, including contributions to the scheme and charges the applicants have paid to that person, its agent, or any person through whom the applicant has applied for the units; or

(b) the contributions of the applicants to the scheme have been invested in accordance with the scheme, the Authority may by notice in writing issue such directions to the person making the offer of units in the scheme as it deems fit, including a direction that the person provide the applicants with an option, on such terms as the Authority may approve, to obtain from that person a refund of all moneys contributed by the applicants or to redeem their units in accordance with the scheme.

[1/2005]

(5) In determining whether to issue a direction under subsection (4) to the person making the offer of units in the collective investment scheme to refund the contributions of the applicants, the Authority shall consider whether the responsible person for the scheme will be able to liquidate the property of the scheme without material adverse financial effect to the applicants, and for this purpose, the factors which the Authority may take into account include—

(a) whether a significant amount of the contributions of the participants has been invested;

(b) the liquidity of the property of the scheme; and

(c) the penalties, if any, payable for liquidating the property.

[1/2005]

(6) For the avoidance of doubt, a direction issued under subsection (4) shall be deemed not to be subsidiary legislation.

(7) If the Authority is of the opinion that any delay in serving a stop order pending the hearing required under subsection (3) is not in the interests of the public, the Authority may, without giving the person making the offer of units in the collective investment scheme an opportunity to be heard, serve an interim stop order on such person directing that no or no further units in a collective investment scheme to which the prospectus or profile statement relates be issued or sold.

[1/2005]

(8) An interim stop order shall, unless revoked, be in force—

(a) in a case where—

(i) it is served during a hearing under subsection (3); or

(ii) a hearing under subsection (3) is commenced while it is in force, until the Authority makes an order under subsection (1) or (2); or

(b) in any other case, for a period of 14 days from the day on which the interim stop order is served.

(9) Subsection (4) shall not apply where only an interim stop order has been served.

(10) Any person who fails to comply with a stop order served under subsection (1) or (2) or an interim stop order served under subsection (7) shall be guilty of an offence and shall be liable on conviction to a fine not exceeding \$150,000 or to imprisonment for a term not exceeding 2 years or to both and, in the case of a continuing offence, to a further fine not exceeding \$15,000 for every day or part thereof during which the offence continues after conviction.

(11) Any person who contravenes subsection (4), or any direction issued to him under that subsection, shall be guilty of an offence and shall be liable on conviction to a fine not exceeding \$100,000 and, in the case of a continuing offence, to a further fine not exceeding \$10,000 for every day or part thereof during which the offence continues after conviction.

[1/2005]

(12) For the purposes of subsections (1) (a) and (2) (a), any reference to a statement shall include a reference to any information presented, regardless of whether such information is in text or otherwise.

[1/2005]

[Aust. Corporations 2001, s. 739]

continued on next page

*Box A1.1 continuation***Lodging supplementary document or replacement document**

298.—(1) If, after a prospectus or profile statement is registered but before the close of the offer of units in a collective investment scheme, or the expiration of 12 months from the date of registration of the prospectus by the Authority, whichever is earlier, the person making that offer becomes aware of—

- (a) a false or misleading statement in the prospectus or profile statement;
- (b) an omission from the prospectus or profile statement of any information that should have been included in it by requirements prescribed under section 296; or
- (c) a new circumstance that—
 - (i) has arisen since the prospectus or profile statement was lodged with the Authority; and
 - (ii) would have been required under this Act to be included in the prospectus or profile statement, if it had arisen before the prospectus or the profile statement, as the case may be, was lodged, and that is materially adverse from the point of view of an investor, the person may lodge a supplementary or replacement prospectus, or a supplementary or replacement profile statement (referred to in this section as a supplementary or replacement document, as the case may be), with the Authority.

[1/2005]

(2) If, after a prospectus or profile statement is registered but before the close of the offer of units in a collective investment scheme, or the expiration of 12 months from the registration of the prospectus by the Authority, whichever is earlier, the person making that offer wishes to update any information in a prospectus or profile statement and he declares in writing to the Authority that none of the situations set out in subsection (1) apply at that time, the person may lodge a supplementary or replacement document with the Authority.

[1/2005]

(3) At the beginning of a supplementary document, there shall be—

- (a) a statement that it is a supplementary prospectus or a supplementary profile statement, as the case may be;
- (b) an identification of the prospectus or profile statement it supplements;
- (c) an identification of any previous supplementary document lodged with the Authority in relation to the offer; and
- (d) a statement that it is to be read together with the prospectus or profile statement it supplements and any previous supplementary document in relation to the offer.

[1/2005]

(4) At the beginning of a replacement document, there shall be—

- (a) a statement that it is a replacement prospectus or a replacement profile statement, as the case may be; and
 - (b) an identification of the prospectus or profile statement it replaces.
- (5) The supplementary document and the replacement document must be dated with the date on which they are lodged with the Authority.
- (6) The person making the offer of units in a collective investment scheme shall take reasonable steps—
- (a) to inform potential investors of the lodgment of any supplementary document or replacement document under subsection (1); and
 - (b) to make available to them the supplementary document or replacement document.

[1/2005]

(7) For the purposes of the application of this Division to events that occur after the lodgment of a supplementary document—

- (a) where the supplementary document is a supplementary prospectus, the prospectus in relation to the offer shall be taken to be the original prospectus together with the supplementary prospectus and any previous supplementary prospectus in relation to the offer; and
- (b) where the supplementary document is a supplementary profile statement, the profile statement in relation to the offer shall be taken to be the original profile statement together with the supplementary profile statement and any previous supplementary profile statement in relation to the offer.

[1/2005]

(8) *(Deleted by Act 1/2005)*

(9) For the purposes of the application of this Division to events that occur after the lodgment of the replacement document—

- (a) where the replacement document is a replacement prospectus, the prospectus in relation to the offer shall be taken to be the replacement prospectus; and
- (b) where the replacement document is a replacement profile statement, the profile statement in relation to the offer shall be taken to be the replacement profile statement.

[1/2005]

(10) Where, prior to the lodgment of the supplementary document or replacement document under subsection (1), applications have been made under the original prospectus or profile statement for units in a collective investment scheme, the person making the offer of units in the scheme—

- (a) shall—
 - (i) within 2 days (excluding any Saturday, Sunday or public holiday) from the date of lodgment of the supplementary document or replacement document, give the applicants notice in writing on how to obtain, or arrange to receive, a copy of the supplementary document or replacement document, as the case may be; and
 - (ii) take all reasonable steps to make available within a reasonable period the supplementary document or replacement document, as the case may be, to the applicants who have indicated that they wish to obtain, or who have arranged to receive, a copy of the supplementary document or replacement document; or
- (b) shall, within 7 days from the date of lodgment of the supplementary document or replacement document, give the applicants the supplementary document or replacement document, as the case may be.

[1/2005]

(11) Any person who contravenes subsection (3), (4), (5) or (6) shall be guilty of an offence and shall be liable on conviction to a fine not exceeding

continued on next page

Box A1.1 continuation

\$50,000 and, in the case of a continuing offence, to a further fine not exceeding \$5,000 for every day or part thereof during which the offence continues after conviction.

[1/2005]

(12) Any person who contravenes subsection (10) shall be guilty of an offence and shall be liable on conviction to a fine not exceeding \$100,000 and, in the case of a continuing offence, to a further fine not exceeding \$10,000 for every day or part thereof during which the offence continues after conviction.

(13) For the purposes of subsection (1) (a), the reference to a statement shall include a reference to any information presented, regardless of whether such information is in text or otherwise.

[1/2005]

[Companies, s. 50A; Aust Corporations 2001, s. 719]

Duration of validity of prospectus and profile statement

299.—(1) No person shall make an offer of units in a collective investment scheme, or issue or sell any units in a collective investment scheme, on the basis of a prospectus or profile statement after the expiration of 12 months from the date of registration by the Authority of the prospectus in relation to such offer, issue or sale.

[1/2005]

(2) Any person who contravenes subsection (1) shall be guilty of an offence and shall be liable on conviction to a fine not exceeding \$50,000 or to imprisonment for a term not exceeding 12 months or to both and, in the case of a continuing offence, to a further fine not exceeding \$5,000 for every day or part thereof during which the offence continues after conviction.

[1/2005]

(3) An issue or a sale of units in a collective investment scheme that is made in contravention of subsection (1) shall not, by reason only of that fact, be voidable or void.

[1/2005]

[Companies, s. 113A]

Restrictions on advertisements, etc.

300.—(1) If a prospectus is required for an offer, or intended offer of units in a collective investment scheme or proposed collective investment scheme, a person shall not—

- (a) advertise the offer or intended offer; or
- (b) publish a statement that—
 - (i) directly or indirectly refers to the offer or intended offer; or
 - (ii) is reasonably likely to induce people to subscribe for or purchase the units, unless the advertisement or publication is authorised by this section.

[16/2003;1/2005]

(2) In determining whether a statement—

- (a) indirectly refers to an offer or intended offer; or
- (b) is reasonably likely to induce people to subscribe for or purchase units in a collective investment scheme, regard shall be had to whether the statement—
 - (i) forms part of the normal advertising of an entity's products or services and is genuinely directed at maintaining its existing customers, or attracting new customers, for those products or services; and
 - (ii) is likely to encourage investment decisions to be made on the basis of the statement rather than on the basis of information contained in a prospectus or profile statement.

[1/2005]

(2A) Notwithstanding subsection (3A), a person may, before a prospectus or profile statement is registered by the Authority, disseminate a preliminary document which has been lodged with the Authority to institutional investors, relevant persons as defined in section 305 (5) and persons to whom an offer referred to in section 305 (2) is to be made without contravening subsection (1), if—

- (a) the front page of the preliminary document contains—
 - (i) the following statement:

"This is a preliminary document and is subject to further amendments and completion in the prospectus to be registered by the Monetary Authority of Singapore.";
 - (ii) a statement that a person to whom a copy of the preliminary document has been issued shall not circulate it to any other person; and
 - (iii) a statement in bold lettering that no offer or agreement shall be made on the basis of the preliminary document to purchase or subscribe for any units in the collective investment scheme to which the preliminary document relates;
- (b) the preliminary document does not contain or have attached to it any form of application that will facilitate the making by any person of an offer of units in the collective investment scheme to which the preliminary document relates, or the acceptance of such an offer by any person; and
- (c) when the prospectus is registered by the Authority, the person takes reasonable steps to notify the persons to whom the preliminary document was issued that the registered prospectus is available for collection.

[1/2005]

(2B) Notwithstanding subsection (3A), a person does not contravene subsection (1) by presenting, before a prospectus or profile statement is registered by the Authority, oral or written material—

- (a) on matters contained in a preliminary document which has been lodged with the Authority, to institutional investors, relevant persons as defined in

continued on next page

Box A1.1 continuation

section 305 (5) or persons to whom an offer referred to in section 305 (2) is to be made; or
 (b) on matters contained in the prospectus or profile statement which has been lodged with the Authority, for the sole purpose of equipping any of the following persons with knowledge of the collective investment scheme to market the scheme under the Financial Advisers Act (Cap. 110):

- (i) a person licensed under that Act in respect of marketing of collective investment schemes;
- (ii) an exempt financial adviser;
- (iii) a person who is a representative in respect of marketing of collective investment schemes under that Act;
- (iv) a representative of an exempt financial adviser.

[1/2005]

(2C) In subsection (2B), “exempt financial adviser” and “representative” have the same meanings as in section 2(1) of the Financial Advisers Act (Cap. 110).

(3) For the avoidance of doubt, a person may disseminate a prospectus or profile statement that has been registered by the Authority under section 296 without contravening subsection (1).

[1/2005]

(3A) Before a prospectus or profile statement is registered, an advertisement or a publication does not contravene subsection (1) if it contains only the following:

- (a) a statement that identifies the person making the offer, the responsible person for the collective investment scheme and, where the collective investment scheme is not a corporation, the collective investment scheme;
- (b) a statement that a prospectus or profile statement for the offer will be made available when the offer is made;
- (c) a statement that anyone wishing to acquire the units in the collective investment scheme will need to make an application in the manner set out in the prospectus or profile statement;
- (d) a statement on how to obtain, or arrange to receive, a copy of the prospectus or profile statement; and
- (e) the investment focus of the collective investment scheme.

[1/2005]

(3B) To satisfy subsection (3A), the advertisement or publication shall include all of the statements referred to in paragraphs (a), (b) and (c) of that subsection, and may include the information referred to in paragraphs (d) and (e).

[1/2005]

(3C) After a prospectus or profile statement is registered with the Authority, an advertisement or a publication does not contravene subsection (1) if it complies with such requirements as may be prescribed by the Authority.

[1/2005]

(4) An advertisement or publication does not contravene subsection (1) if it—

- (a) consists solely of a disclosure, notice or report required under this Act, or any listing rules or other requirements of a securities exchange, futures exchange or overseas securities exchange, made by any person, provided that the disclosure, notice or report complies with such requirements as may be prescribed by the Authority;
- (aa) consists solely of a notice or report of a meeting or proposed meeting of the participants of the collective investment scheme, or a general meeting or proposed general meeting of the person making the offer, the responsible person or any entity, provided that the notice or report complies with such requirements as may be prescribed by the Authority, or a presentation of oral or written material on matters so contained in the notice or report at the meeting or general meeting;
- (b) consists solely of a report about the collective investment scheme or proposed collective investment scheme that is issued pursuant to this Act and the Code on Collective Investment Schemes;
- (ba) consists solely of a statement made by the person making the offer or the responsible person that a prospectus or profile statement in respect of the offer or intended offer has been lodged with the Authority;
- (c) is a news report, or a genuine comment, by a person other than a person referred to in paragraph (d) (i), (ii), (iii) or (iv), in a newspaper, periodical or magazine or on radio or television, or any other means of broadcasting or communication, relating to—
 - (i) a prospectus or profile statement that has been lodged with the Authority or information contained in such a prospectus or profile statement;
 - (ii) a disclosure, notice or report referred to in paragraph (a);
 - (iii) a notice, report, presentation, meeting, proposed meeting, general meeting or proposed general meeting referred to in paragraph (aa); or
 - (iv) a report referred to in paragraph (b);
- (d) is a report about the units in the collective investment scheme which are the subject of the offer or intended offer, published by someone who is not—
 - (i) the person making the offer, the responsible person for the scheme, its agent or distributor;
 - (ii) a director or an equivalent person of the person making the offer or the responsible person for the scheme;
 - (iii) a person who has an interest in the success of the issue or sale of the units; or
 - (iv) a person acting at the instigation of, or by arrangement with, any person referred to in sub-paragraph (i), (ii) or (iii);
- (e) is a report about the units in the collective investment scheme which are the subject of the offer or intended offer, published and delivered to any institutional investor not later than 14 days prior to the date of lodgment of the prospectus, provided that—
 - (i) the offer is also made or will also be made in one or more other countries;
 - (ii) the publication and delivery of such report in that other country or any one of those other countries do not infringe any law, code or other requirement of that country;
 - (iii) the report and the manner of its publication and delivery in Singapore comply with such other requirements as may be prescribed by the Authority; and
 - (iv) the person issuing the report complies with such requirements as may be prescribed by the Authority; or

continued on next page

Box A1.1 continuation

(f) is a publication made by the person making the offer or the responsible person for the scheme solely to correct or provide clarification on any erroneous or inaccurate information or comment contained in—
 (i) an earlier news report or a genuine comment referred to in paragraph (c); or
 (ii) an earlier publication published in the ordinary course of business of publishing a newspaper, periodical or magazine, or of broadcasting by radio, television or any other means of broadcasting or communication, referred to in subsection (5), provided that the first-mentioned publication does not contain any material information that is not included in the prospectus.

[1/2005]

(5) A person does not contravene subsection (1) if—

(a) he publishes an advertisement or publication in the ordinary course of a business of—

(i) publishing a newspaper, periodical or magazine; or

(ii) broadcasting by radio, television, or any other means of broadcasting or communication; and

(b) he did not know, and had no reason to suspect, that its publication would constitute a contravention of subsection (1).

(6) Subsection (4) (c) and (d) shall not apply to an advertisement or statement if any person gives consideration or any other benefit for the publication of the advertisement or statement.

(7) Any person who contravenes subsection (1) or who knowingly authorised or permitted the publication or dissemination in contravention of subsection (1) shall be guilty of an offence and shall be liable on conviction to a fine not exceeding \$50,000 or to imprisonment for a term not exceeding 12 months or to both and, in the case of a continuing offence, to a further fine not exceeding \$5,000 for every day or part thereof during which the offence continues after conviction.

[1/2005]

(8) This section does not affect any liability that a person has under any other law.

(9) The Authority may exempt any person or class of persons from this section, subject to such conditions as may be determined by the Authority.

(10) Any person who contravenes any of the conditions under subsection (9) shall be guilty of an offence and shall be liable on conviction to a fine not exceeding \$50,000 and, in the case of a continuing offence, to a further fine not exceeding \$5,000 for every day or part thereof during which the offence continues after conviction.

(11) For the purposes of this section, any reference to publishing a statement shall be construed as including a reference to making a statement, whether oral or written, which is reasonably likely to be published.

[1/2005]

(12) For the purposes of subsections (1) and (2), any reference to a statement shall include a reference to any information presented, regardless of whether such information is in text or otherwise.

[1/2005]

[Companies, s. 48; Aust. FSR Bill 2001, Clause 1018A]

Issue of units where prospectus indicates application to list on securities exchange

301.—(1) Where a prospectus states or implies that application has been or will be made for permission for the units in a collective investment scheme offered thereby to be listed for quotation on any securities exchange, and—

(a) the permission is not applied for in the form required by the securities exchange within 3 days from the date of the issue of the prospectus; or

(b) the permission is not granted before the expiration of 6 weeks from the date of the issue of the prospectus or such longer period not exceeding 12 weeks from the date of the issue as is, within those 6 weeks, notified to the applicant by or on behalf of the securities exchange, then—

(i) any issue whenever made of units made on an application in pursuance of the prospectus shall be void; and

(ii) any person who continues to issue such units after the period specified in paragraph (a) or (b) shall be guilty of an offence and shall be liable on conviction to a fine not exceeding \$150,000 or to imprisonment for a term not exceeding 2 years or to both and, in the case of a continuing offence, to a further fine not exceeding \$15,000 for every day or part thereof during which the offence continues after conviction.

[1/2005]

(2) Where the permission has not been applied for, or has not been granted as mentioned under subsection (1), applications for units in the collective investment scheme have been made and—

(a) the contributions of the applicants to the scheme have not yet been invested in accordance with the scheme—

(i) in a case where units in the scheme have not been issued to the applicants, the responsible person for the scheme shall treat such applications as having been withdrawn; or

(ii) in a case where units in the scheme have been issued to the applicants, the issue of the units shall be deemed to be void, and the responsible person shall within 7 days after the period specified in subsection (1) (a) or (b), whichever is applicable, pay to the applicants all moneys which the applicants have paid for the units, including contributions to the scheme and charges the applicants have paid to the responsible person, its agent, or any person through whom the applicant has applied for the units; or

(b) the contributions of the applicants to the scheme have been invested in accordance with the scheme, the Authority may by notice in writing issue such directions to the responsible person for the scheme as it deems fit, including a direction that the responsible person provide the applicants with an option, on such terms as the Authority may approve, to obtain from the responsible person a refund of all moneys contributed by the applicants or to redeem their units in accordance with the scheme.

(3) In determining whether to issue a direction under subsection (2) (b) to the responsible person to refund the contributions of the applicants, the Authority shall consider whether the responsible person for the collective investment scheme will be able to liquidate the property of the scheme without material adverse financial effect to the applicants, and for this purpose, the factors which the Authority may take into account include—

continued on next page

Box A1.1 continuation

- (a) whether a significant amount of the contributions of the participants has been invested;
- (b) the liquidity of the property of the scheme; and
- (c) the penalties, if any, payable for liquidating the property.
- (4) Any responsible person who contravenes subsection (2) or any of the directions issued under that subsection shall be guilty of an offence and shall be liable on conviction to a fine not exceeding \$100,000 and, in the case of a continuing offence, to a further fine not exceeding \$10,000 for every day or part thereof during which the offence continues after conviction.
- (5) Any responsible person to whom a notice is given under subsection (2) shall comply with such direction as may be contained in the notice.
- (6) For the avoidance of doubt, a direction issued under subsection (2) shall be deemed not to be subsidiary legislation.
- (7) All moneys received from applicants as payment for the units, including contributions to the scheme and charges which the applicants have paid to the responsible person, its agent, or any person through whom the applicant has applied for the units, shall be kept in a separate bank account so long as the responsible person for the collective investment scheme may become liable to repay it under subsection (2).

[16/2003]

(8) Any responsible person for a scheme which is not in compliance with subsection (7) and, where the scheme is a corporation, every officer thereof, shall be guilty of an offence and shall be liable on conviction to a fine not exceeding \$50,000 or to imprisonment for a term not exceeding 12 months or to both and, in the case of a continuing offence, to a further fine not exceeding \$5,000 for every day or part thereof during which the offence continues after conviction.

(9) Where the securities exchange has, within the period specified in subsection (1) (b), granted permission subject to compliance with such requirements as may be specified by the securities exchange, permission shall be deemed to have been granted by the securities exchange if—

- (a) in a case where the responsible person for the scheme is a corporation, the directors of the corporation; or
- (b) in a case where the responsible person for the scheme is not a corporation, such persons as may be required by the securities exchange, have given to the securities exchange an undertaking in writing to comply with the requirements of the securities exchange.

(10) Any person who fails to comply with any undertaking given to a securities exchange under subsection (9) shall be guilty of an offence and shall be liable on conviction to a fine not exceeding \$50,000 and, in the case of a continuing offence, to a further fine not exceeding \$5,000 for every day or part thereof during which the offence continues after conviction.

(11) A person shall not issue a prospectus inviting persons to subscribe for or purchase units in a collective investment scheme if it includes—

- (a) a false or misleading statement that permission has been granted for those units to be listed for quotation on, dealt in or quoted on any securities exchange; or
- (b) any statement in any way referring to any such permission or to any application or intended application for any such permission, or to listing for quotation on, dealing in or quoting the units on any securities exchange, or to any requirements of a securities exchange, unless that statement is or is to the effect that permission has been granted or that application has been or will be made to the securities exchange within 3 days from the date of issue of the prospectus or the statement has been approved by the Authority for inclusion in the prospectus.

[16/2003;1/2005]

(12) Any person who contravenes subsection (11) shall be guilty of an offence and shall be liable on conviction to a fine not exceeding \$50,000 or to imprisonment for a term not exceeding 12 months or to both and, in the case of a continuing offence, to a further fine not exceeding \$5,000 for every day or part thereof during which the offence continues after conviction.

(13) Where a prospectus contains a statement to the effect that the constituent documents for the collective investment scheme comply, or have been drawn so as to comply, with the requirements of any securities exchange, the prospectus shall, unless the contrary intention appears from the prospectus, be deemed for the purposes of subsection (11) (b) to be a prospectus that includes a statement that application has been, or will be, made for permission for the units to which the prospectus relates, to be listed for quotation on the securities exchange.

[1/2005]

*[Companies, s. 53]***Application of provisions relating to securities**

302.—(1) Sections 247, 249, 249A, 252, 253, 254 and 255 shall, with the necessary modifications, apply in relation to an offer of units in a collective investment scheme as they apply in relation to an offer of securities in Division 1 of this Part.

[1/2005]

(2) For the purposes of subsection (1), references in those sections to securities and to a person subscribing for, purchasing or acquiring securities shall be read as references to units in a collective investment scheme and to a person subscribing for, purchasing or acquiring such units, respectively.

[1/2005]

(3) For the purposes of subsection (1), references in sections 253 and 254 to an offer referred to in section 280 shall be read as a reference to an offer referred to in section 305C.

[1/2005]

(4) For the purposes of subsection (1), references in sections 249, 249A, 253 and 254 to the issuer shall be read as a reference to the responsible person.

[1/2005]

*[Companies, s. 113 (1)]***Subdivision (4)—Exemptions****Issue or transfer for no consideration**

302A.—(1) Subdivisions (2) and (3) of this Division shall not apply to an offer of units in a collective investment scheme (other than an offer of an option to subscribe for or purchase such units) if no consideration is or will be given for the issue or transfer of the units.

continued on next page

Box A1.1 continuation

[1/2005]

(2) Subdivisions (2) and (3) of this Division shall not apply to an offer of an option to subscribe for or purchase units in a collective investment scheme if—

- (a) no consideration is or will be given for the issue or transfer of the option; and
- (b) no consideration is or will be given for the underlying units on the exercise of the option.

[1/2005]

Small offers

302B.—(1) Subdivisions (2) and (3) of this Division shall not apply to personal offers of units in a collective investment scheme by a person if—

(a) the total amount raised by the person from such offers within any period of 12 months does not exceed—

- (i) \$5 million (or its equivalent in a foreign currency); or
 - (ii) such other amount as may be prescribed by the Authority in substitution for the amount specified in sub-paragraph (i);
- (b) in respect of each offer, the person making the offer gives the person to whom he makes the offer—

(i) the following statement in writing:

“This offer is made in reliance on the exemption under section 302B (1) of the Securities and Futures Act. It is not made in or accompanied by a prospectus that is registered by the Monetary Authority of Singapore and the scheme is not authorised or recognised by the Authority.”; and

(ii) a notification in writing that the units to which the offer (referred to in this sub-paragraph as the initial offer) relates shall not be subsequently sold to any person unless the offer resulting in such subsequent sale is made—

- (A) in compliance with Subdivisions (2) and (3) of this Division;
- (B) in reliance on subsection (8) (c) or any other exemption under any provision of this Subdivision (other than this subsection); or
- (C) where at least 6 months have elapsed from the date the units were acquired under the initial offer, in reliance on the exemption under this subsection;

(c) none of the offers is accompanied by an advertisement making an offer or calling attention to the offer or intended offer;

(d) no selling or promotional expenses are paid or incurred in connection with each offer other than those incurred for administrative or professional services, or by way of commission or fee for services rendered by any of the following persons:

- (i) the holder of a capital markets services licence to deal in securities;
 - (ii) an exempt person in respect of dealing in securities;
 - (iii) a person licensed under the Financial Advisers Act (Cap. 110) in respect of marketing of collective investment schemes;
 - (iv) an exempt financial adviser as defined in section 2 (1) of the Financial Advisers Act; or
 - (v) a person who is licensed, approved, authorised or otherwise regulated under the laws, codes or other requirements of any foreign jurisdiction in respect of dealing in securities or marketing of collective investment schemes, or who is exempted therefrom in respect of such dealing or marketing;
- and

[1/2005]

(e) no prospectus in respect of any of the offers has been registered by the Authority or, where a prospectus has been registered—

- (i) the prospectus has expired pursuant to section 299; or
- (ii) the person making the offer has before making the offer informed the Authority by notice in writing of its intent to make the offer in reliance on the exemption under this subsection.

(2) For the purposes of subsection (1) (b), where any notice, circular, material, publication or other document is issued in connection with the offer, the person making the offer is deemed to have given the statement and notification to the person to whom he makes the offer in accordance with that provision if such statement or notification is contained in the first page of that notice, circular, material, publication or document.

[1/2005]

(3) For the purposes of subsection (1), a personal offer of units in a collective investment scheme is one that—

- (a) may only be accepted by the person to whom it is made; and
- (b) is made to a person who is likely to be interested in that offer, having regard to—
 - (i) any previous contact before the date of the offer between the person making the offer and that person;
 - (ii) any previous professional or other connection established before that date between the person making the offer and that person; or
 - (iii) any previous indication (whether through statements made or actions carried out) before that date by that person to the person making the offer or any of the persons specified in subsection (1) (d) (i) to (v) that he is interested in offers of that kind.

[1/2005]

(4) In determining the amount raised by an offer of units in a collective investment scheme, the following shall be included:

- (a) the amount payable for the units at the time when they are issued or sold;
- (b) if the units are issued partly-paid, any amount payable at a future time if a call is made; and
- (c) if the units carry a right (by whatever name called) to be converted into other units or to acquire other units in a collective investment scheme, any amount payable on the exercise of the right to convert them into, or to acquire, other units in a collective investment scheme.

[1/2005]

(5) In determining whether the amount raised by a person from offers within a period of 12 months exceeds the applicable amount specified in subsection (1) (a), each amount raised—

- (a) by that person from any offer of units in the same collective investment scheme; or
 - (b) by that person or another person from any offer of securities which is a closely related offer,
- if any, within that period in reliance on the exemption under subsection (1), section 272A (1) or 282V (1) shall be included.

[1/2005]

(6) Whether an offer is a closely related offer under subsection (5) shall be determined by considering such factors as the Authority may prescribe.

continued on next page

Box A1.1 continuation

[1/2005]

(7) For the purpose of this section, an offer of units in a collective investment scheme made by a person acting as an agent of another person shall be treated as an offer made by that other person.

[1/2005]

(8) Where units acquired through an offer made in reliance on the exemption under subsection (1) (referred to in this subsection as an initial offer) are subsequently sold by the person who acquired the units to another person, Subdivisions (2) and (3) of this Division shall apply to the offer from the first-mentioned person to the second-mentioned person which resulted in that sale, unless—

(a) such offer is made in reliance on an exemption under any provision of this Subdivision (other than this section);
 (b) such offer is made in reliance on an exemption under subsection (1) and at least 6 months have elapsed from the date the units were acquired under the initial offer; or

(c) such offer is one—

(i) that may be accepted only by the person to whom it is made;

(ii) that is made to a person who is likely to be interested in the offer having regard to—

(A) any previous contact before the date of the offer between the person making the initial offer and that person;

(B) any previous professional or other connection established before that date between the person making the initial offer and that person; or

(C) any previous indication (whether through statements made or actions carried out) before that date by that person to the person making the initial offer or any of the persons specified in subsection (1) (d) (i) to (v) that he is interested in offers of that kind;

(iii) in respect of which the first-mentioned person has given the second-mentioned person—

(A) the following statement in writing:

“This offer is made in reliance on the exemption under section 302B (8) (c) of the Securities and Futures Act. It is not made in or accompanied by a prospectus that is registered by the Monetary Authority of Singapore and the scheme is not authorised or recognised by the Authority.”; and

(B) a notification in writing that the units being offered shall not be subsequently sold to any person unless the offer resulting in such subsequent sale is made—

(BA) in compliance with Subdivisions (2) and (3) of this Division;

(BB) in reliance on this subsection or any other exemption under any provision of this Subdivision (other than subsection (1)); or

(BC) where at least 6 months have elapsed from the date the units were acquired under the initial offer, in reliance on the exemption under subsection (1);

(iv) that is not accompanied by an advertisement making an offer or calling attention to the offer or intended offer; and

(v) in respect of which no selling or promotional expenses are paid or incurred in connection with the offer other than those incurred for administrative or professional services, or by way of commission or fee for services rendered by any of the persons specified in subsection (1) (d) (i) to (v).

[1/2005]

(9) Subsection (2) shall apply, with the necessary modifications, in relation to the statement and notification referred to in subsection (8) (c) (iii).

[1/2005]

(10) In subsections (1) (c) and (8) (c) (iv), “advertisement” means—

(a) a written or printed communication;

(b) a communication by radio, television or other medium of communication; or

(c) a communication by means of a recorded telephone message,

that is published in connection with an offer of units in a collective investment scheme, but does not include—

(i) a document—

(A) purporting to describe the units in a collective investment scheme being offered; and

(B) purporting to have been prepared for delivery to and review by persons to whom the offer is made so as to assist them in making an investment decision in respect of the units being offered;

(ii) a publication which consists solely of a disclosure, notice or report required under this Act, or any listing rules or other requirements of a securities exchange, futures exchange or overseas securities exchange, which is made by any person; or

(iii) a publication which consists solely of a notice or report of a meeting or proposed meeting of the participants of the collective investment scheme, or a general meeting or proposed general meeting of the person making the offer, the responsible person or any entity, or a presentation of oral or written material on matters so contained in the notice or report at the meeting or general meeting.

[1/2005]

Private placement

302C.—(1) Subdivisions (2) and (3) of this Division shall not apply to offers of units in a collective investment scheme that are made by a person if—

(a) the offers are made to no more than 50 persons within any period of 12 months;

(b) none of the offers is accompanied by an advertisement making an offer or calling attention to the offer or intended offer;

(c) no selling or promotional expenses are paid or incurred in connection with each offer other than those incurred for administrative or professional services, or by way of commission or fee for services rendered by any of the persons specified in section 302B (1) (d) (i) to (v); and

[1/2005]

(d) no prospectus in respect of any of the offers has been registered by the Authority or, where a prospectus has been registered—

(i) the prospectus has expired pursuant to section 299; or

(ii) the person making the offer has before making the offer—

(A) informed the Authority by notice in writing of its intent to make the offer in reliance on the exemption under this subsection; and

(B) taken reasonable steps to inform in writing the person to whom the offer is made that the offer is made in reliance on the exemption under this subsection.

continued on next page

Box A1.1 continuation

- (2) The Authority may prescribe such other number of persons in substitution for the number specified in subsection (1) (a). [1/2005]
- (3) In determining whether offers of units in a collective investment scheme by a person are made to no more than the applicable number of persons specified in subsection (1) (a) within a period of 12 months, each person to whom—
 (a) an offer of units in the same collective investment scheme is made by the first-mentioned person; or
 (b) an offer of securities is made by the first-mentioned person or another person where such offer is a closely related offer, if any, within that period in reliance on the exemption under this section, section 272B or 282W shall be included. [1/2005]
- (4) Whether an offer is a closely related offer under subsection (3) shall be determined by considering such factors as the Authority may prescribe. [1/2005]
- (5) For the purposes of subsection (1)—
 (a) an offer of units in a collective investment scheme to an entity or to a trustee shall be treated as an offer to a single person, provided that the entity or trust is not formed primarily for the purpose of acquiring the units which are the subject of the offer;
 (b) an offer of units in a collective investment scheme to an entity or to a trustee shall be treated as an offer to the equity owners, partners or members of that entity, or to the beneficiaries of the trust, as the case may be, if the entity or trust is formed primarily for the purpose of acquiring the units which are the subject of the offer;
 (c) an offer of units in a collective investment scheme to 2 or more persons who will own the units acquired as joint owners shall be treated as an offer to a single person;
 (d) an offer of units in a collective investment scheme to a person acting on behalf of another person (whether as an agent or otherwise) shall be treated as an offer made to that other person;
 (e) offers of units in a collective investment scheme made by a person as an agent of another person shall be treated as offers made by that other person;
 (f) where an offer of units in a collective investment scheme is made to a person with a view to another person acquiring an interest in those units by virtue of section 4, only the second-mentioned person shall be counted for the purposes of determining whether offers of the units are made to no more than the applicable number of persons specified in subsection (1) (a); and
 (g) where—
 (i) an offer of units in a collective investment scheme is made to a person in reliance on the exemption under subsection (1) with a view to those units being subsequently offered for sale to another person; and
 (ii) that subsequent offer—
 (A) is not made in reliance on an exemption under any provision of this Subdivision; or
 (B) is made in reliance on an exemption under subsection (1) or section 305C,
 both persons shall be counted for the purposes of determining whether offers of the units are made to no more than the applicable number of persons specified in subsection (1) (a). [1/2005]
- (6) In subsection (1) (b), “advertisement” has the same meaning as in section 302B (10). [1/2005]

Offer or invitation made under certain circumstances

303.—(1) Subdivision (3) of this Division shall not apply to an offer of units in a collective investment scheme if it is made in relation to units in a collective investment scheme (not being such excluded units in a scheme as may be prescribed by the Authority) that have been previously issued, are listed for quotation or quoted on a securities exchange, and are traded on the exchange.

(2) Subdivisions (2) and (3) of this Division shall not apply to an offer of units in a collective investment scheme if it is an offer to enter into an underwriting agreement relating to units in a collective investment scheme. [1/2005]

[Companies, s. 106B (1) (b)]

Offer made to institutional investors

304. Subdivisions (2) and (3) of this Division shall not apply to an offer of units in a collective investment scheme, whether or not they have been previously issued, made to an institutional investor. [1/2005]

[Companies, s. 106C]

First sale of units acquired pursuant to section 304

304A.—(1) Notwithstanding sections 302B, 302C, 303 (1) and 305B but subject to subsection (2), where units in a collective investment scheme acquired pursuant to an offer made in reliance on the exemption under section 304 are first sold to any person other than an institutional investor, then Subdivisions (2) and (3) of this Division shall apply to the offer resulting in that sale. [1/2005]

(2) Subsection (1) shall not apply where the units in a collective investment scheme acquired are of the same class as, or can be converted into units of the same class as, other units in the scheme—

- (a) an offer of which has previously been made in or accompanied by a prospectus; and
 (b) which are listed for quotation on a securities exchange.

continued on next page

*Box A1.1 continuation***Offer made to accredited investors and certain other persons**

305.—(1) Except to such extent and with such modifications as may be prescribed by the Authority, Subdivisions (2) and (3) of this Division shall not apply to an offer of units in a collective investment scheme (referred to in this section as a restricted scheme), where the offer is made to a relevant person, if the conditions in subsection (3) are satisfied.

[1/2005]

(2) Except to such extent and with such modifications as may be prescribed by the Authority, Subdivisions (2) and (3) of this Division shall not apply to an offer of units in a collective investment scheme (also referred to in this section as a restricted scheme) to a person who acquires the units as principal if the offer is on terms that the units may only be acquired at a consideration of not less than \$200,000 (or its equivalent in a foreign currency) for each transaction, whether such amount is to be paid for in cash or by exchange of securities or other assets, and if the conditions in subsection (3) are satisfied.

[1/2005]

(3) The conditions referred to in subsections (1) and (2) are—

- (a) the offer is not accompanied by an advertisement making an offer or calling attention to the offer or intended offer;
- (b) no selling or promotional expenses are paid or incurred in connection with the offer other than those incurred for administrative or professional services, or by way of commission or fee for services rendered by any of the persons specified in section 302B (1) (d) (i) to (v); and
- (c) no prospectus in respect of the offer has been registered by the Authority or, where a prospectus has been registered—
 - (i) the prospectus has expired pursuant to section 299; or
 - (ii) the person making the offer has before making the offer—
 - (A) informed the Authority by notice in writing of its intent to make the offer in reliance on the exemption under this subsection; and
 - (B) taken reasonable steps to inform in writing the person to whom the offer is made that the offer is made in reliance on the exemption under this subsection.

(4) Deleted by Act 2/2009, wef 29/07/2009.

(5) In this section—

“advertisement” means—

- (a) a written or printed communication;
 - (b) a communication by radio, television or other medium of communication; or
 - (c) a communication by means of a recorded telephone message,
- that is published in connection with an offer of units in a collective investment scheme, but does not include—

- (i) an information memorandum;
- (ii) a publication which consists solely of a disclosure, notice or report required under this Act, or any listing rules or other requirements of a securities exchange, futures exchange or overseas securities exchange, which is made by any person; or
- (iii) a publication which consists solely of a notice or report of a meeting or proposed meeting of the participants of the collective investment scheme, or a general meeting or proposed general meeting of the person making the offer, the responsible person or any entity, or a presentation of oral or written material on matters so contained in the notice or report at the meeting or general meeting;

“information memorandum” means a document—

- (a) purporting to describe the units in a collective investment scheme being offered; and
- (b) purporting to have been prepared for delivery to and review by relevant persons and persons to whom an offer referred to in subsection (2) is to be made so as to assist them in making an investment decision in respect of the units being offered;

“relevant person” means—

- (a) an accredited investor;
- (b) a corporation the sole business of which is to hold investments and the entire share capital of which is owned by one or more individuals, each of whom is an accredited investor;
- (c) a trustee of a trust the sole purpose of which is to hold investments and each beneficiary of which is an individual who is an accredited investor;
- (d) an officer or equivalent person of the person making the offer (such person being an entity) or a spouse, parent, brother, sister, son or daughter of that officer or equivalent person; or
- (e) a spouse, parent, brother, sister, son or daughter of the person making the offer (such person being an individual).

[1/2005]

(6) Notwithstanding any requirement under section 99 or any regulations made thereunder that a person has to deal in securities for his own account with or through a person prescribed by the Authority so that he can qualify as an exempt person, a person who acquires units in a collective investment scheme under section 304 or this section for his own account without complying with such requirement shall be considered an exempt person even though he does not comply with that requirement.

[1/2005]

(7) The Authority may, by order published in the *Gazette*, specify an amount in substitution of any amount specified in subsection (2).

[1/2005]

[Companies, s. 106D]

First sale of units acquired pursuant to section 305

305A.—(1) Notwithstanding sections 302B, 302C, 303 (1) and 305B but subject to subsection (5), where units in a collective investment scheme acquired pursuant to an offer made in reliance on an exemption under section 305 are first sold to any person other than—

- (a) an institutional investor;
- (b) a relevant person as defined in section 305 (5); or

continued on next page

Box A1.1 continuation

(c) any person pursuant to an offer referred to in section 305 (2), then Subdivisions (2) and (3) of this Division shall apply to the offer resulting in that sale.

[1/2005]

(2) Subject to subsection (5), securities of a corporation (other than a corporation that is an accredited investor)—

(a) the sole business of which is to hold investments; and

(b) the entire share capital of which is owned by one or more individuals each of whom is an accredited investor,

shall not be transferred within 6 months after the corporation has acquired any units in a collective investment scheme pursuant to an offer made in reliance on an exemption under section 305, unless—

(i) that transfer—

(A) is made only to institutional investors or relevant persons as defined in section 305 (5); or

(B) arises from an offer referred to in section 275 (1A);

(ii) no consideration is or will be given for the transfer; or

(iii) the transfer is by operation of law.

[1/2005]

(3) Subject to subsection (5), where—

(a) the sole purpose of a trust (other than a trust the trustee of which is an accredited investor) is to hold investments; and

(b) each beneficiary of the trust is an individual who is an accredited investor,

the beneficiaries' rights and interest (howsoever described) in the trust shall not be transferred within 6 months after units in a collective investment scheme are acquired for the trust pursuant to an offer made in reliance on an exemption under section 305, unless—

(i) that transfer—

(A) is made only to institutional investors or relevant persons as defined in section 305 (5); or

(B) arises from an offer that is made on terms that such rights or interest are acquired at a consideration of not less than \$200,000 (or its equivalent in a foreign currency) for each transaction, whether such amount is to be paid for in cash or by exchange of securities or other assets;

(ii) no consideration is or will be given for the transfer; or

(iii) the transfer is by operation of law.

[1/2005]

(4) For the avoidance of doubt, the reference to beneficiaries in subsection (3) shall include a reference to unit holders of a business trust and participants of a collective investment scheme.

[1/2005]

(5) Subsections (1), (2) and (3) shall not apply where the units in a collective investment scheme acquired are of the same class as other units in the scheme—

(a) an offer of which has previously been made in or accompanied by a prospectus; and

(b) which are listed for quotation on a securities exchange.

Offer made using offer information statement

305B.—(1) Subject to subsection (2), Subdivision (3) of this Division shall not apply to an offer of units in a collective investment scheme whose units are listed for quotation on a securities exchange, whether by means of a rights issue or otherwise, if—

(a) an offer information statement relating to the offer which complies with such form and content requirements as may be prescribed by the Authority is lodged with the Authority; and

(b) the offer is made in or accompanied by the offer information statement referred to in paragraph (a).

[1/2005]

(2) Subsection (1) shall apply to an offer of units referred therein only for a period of 6 months from the date of lodgment of the offer information statement relating to that offer.

[1/2005]

(3) The Authority may, on the application of any person interested, modify the prescribed form and content of the offer information statement in such manner as is appropriate, subject to such conditions or restrictions as may be determined by the Authority.

[1/2005]

(4) Sections 249, 249A, 253, 254 and 255 (as applied to this Division by virtue of section 302) and such requirements as may be prescribed by the Authority shall apply in relation to an offer information statement referred to in subsection (1) as they apply in relation to a prospectus.

[1/2005]

(5) For the purposes of subsection (4)—

(a) a reference in sections 249 and 249A to the registration of the prospectus shall be read as a reference to the lodgment of the offer information statement; and

(b) a reference in section 253 or 254 to any information or new circumstance required to be included in a prospectus shall be read as a reference to any information prescribed under subsection (1) (a).

[1/2005]

(6) Where the written consent of an expert is required to be given under section 249 (as applied in relation to an offer information statement under subsection (4)), that written consent shall be lodged with the Authority at the same time as the lodgment of the statement.

[1/2005]

(7) Where the written consent of an issue manager or underwriter is required to be given under section 249A (as applied in relation to an offer information statement under subsection (4)), that written consent shall be lodged with the Authority at the same time as the lodgment of the statement.

continued on next page

Box A1.1 continuation

[1/2005]

Making offer using automated teller machine or electronic means

305C.—(1) Subject to subsection (3) and such requirements as may be prescribed by the Authority, a person making an offer of units in a collective investment scheme using—

(a) any automated teller machine; or

(b) such other electronic means as may be prescribed by the Authority,

is exempted from the requirement under section 296 (1) (a) that the offer be made in or accompanied by a prospectus in respect of the offer or, where applicable, the requirement under section 296 (2) that the offer be made in or accompanied by a profile statement in respect of the offer.

[1/2005]

(2) For the avoidance of doubt, a prospectus which complies with all other requirements of section 296 (1) (a) or, where applicable, a profile statement which complies with all other requirements of section 296 (2) must still be prepared and issued in respect of any offer referred to in subsection (1).

[1/2005]

(3) Subsection (1) shall not apply unless the automated teller machine or prescribed electronic means indicates to a prospective subscriber or buyer—

(a) how he can obtain, or arrange to receive, a copy of the prospectus or, where applicable, profile statement in respect of the offer; and

(b) that he should read the prospectus or, where applicable, profile statement before submitting his application,

before enabling him to submit his application to subscribe for or purchase units.

[1/2005]

Power of Authority to exempt

306.—(1) The Authority may exempt any person or class of persons, subject to such conditions as the Authority may determine, from complying with all or any of the provisions of this Division or any regulations made thereunder in relation to an offer in respect of any unit or class of units.

[1/2005]

(2) Any person who contravenes any of the conditions under subsection (1) shall be guilty of an offence and shall be liable on conviction to a fine not exceeding \$150,000 and, in the case of a continuing offence, to a further fine not exceeding \$15,000 for every day or part thereof during which the offence continues after conviction.

(3) This Division shall not apply in the case of the sale of any unit in a collective investment scheme by a personal representative, liquidator, receiver or trustee in bankruptcy in the ordinary course of the realisation of assets for the purposes of the sale.

[Companies, s. 119]

Revocation of exemption

307.—(1) Where the Authority considers that it is necessary in the interest of the public or for the protection of investors, it may revoke any exemption under this Subdivision (including an exemption granted under section 306 (1)), subject to such conditions as it thinks fit.

(2) The Authority may revoke an exemption under subsection (1) without giving the person affected by the revocation an opportunity to be heard, but the person may, within 14 days of the revocation, apply to the Authority for the revocation to be reviewed by the Authority, and the revocation shall remain in effect unless it is withdrawn by the Authority.

(3) A revocation under this section shall be final and conclusive and there shall be no appeal therefrom.

[Companies, s. 119]

Transactions under exempted offers subject to Division 2 of Part XII of Companies Act and Part XII of this Act

308. For the avoidance of doubt, it is hereby declared that in relation to any transaction carried out under an exempted offer under this Part, nothing in this Part shall limit or diminish any liability which any person may incur in respect of any relevant offence under Division 2 of Part XII of the Companies Act (Cap. 50) or Part XII of this Act or any penalty, award of compensation or punishment in respect of any such offence.

[1/2005]

[Companies, s. 106L]

Division 3—Securities Hawking

Securities hawking prohibited

309.—(1) No person shall make an offer to any person of securities for subscription or purchase, or an invitation to any person to subscribe for or purchase securities, in the course of, or arising from, an unsolicited meeting with that other person.

(2) Subsection (1) shall not apply to any person who makes an offer or invitation in respect of securities that does not need a prospectus by virtue of section 274, 275, 304 or 305.

(3) The Authority may exempt—

(a) any person or class of persons; or

(b) any class or description of securities,

from compliance with subsection (1), subject to such conditions as may be determined by the Authority.

[16/2003]

(4) Every person who acts, incites, causes or procures any person to act in contravention of subsection (1) shall be guilty of an offence and shall be liable on conviction to a fine not exceeding \$10,000 or to imprisonment for a term not exceeding 6 months or to both and, in the case of a second or subsequent offence, to a fine not exceeding \$20,000 or to imprisonment for a term not exceeding 12 months or to both.

(5) Where any person is convicted of having made an offer or invitation in contravention of subsection (1), the court before which he is convicted may order that any contract made as a result of the offer or invitation shall be void and may give such consequential directions as it thinks proper for the repayment of any money or the retransfer of any securities.

continued on next page

Box A1.1 continuation

(6) An appeal against any order made under subsection (5) and any consequential directions shall lie to the High Court.

(7) In this section—

(a) “securities” has the same meaning as in section 2 and also includes the securities of a corporation, whether the corporation is in existence or is to be formed;

(b) a reference to an offer or invitation in respect of securities for subscription or purchase shall be construed as including an offer or invitation in respect of securities by way of barter or exchange.

[16/2003]

[Companies, s. 400; Aust. Corporations 2001, s. 736]

Source: Government of Singapore. http://statutes.agc.gov.sg/non_version/cgj-bin/cgj_retrieve.pl?actno=REVED-289

Appendix 2: Singapore Exchange Rulebook

Box A2.1 Singapore Exchange Rulebook

SGX Rulebooks > Mainboard Rules >

Contents:

Chapter 3 Debt Securities

Part I Scope of Chapter

301

302

Part II Listing Requirements for Local Debt Securities

303

Part III Listing Requirements for Foreign Debt Securities

304

Part IV General Requirements for Debt Securities

305 Paying Agent

306 Release of Reports

307 Adjustments

308 Trustee and Trust Deed

309 Medium Term Note Programme

Part V Listing Procedures for Debt Securities

310 Time Schedule

Content of Prospectus, Offering Memorandum or Introductory Document

Documents to be Submitted with the Prospectus, Offering Memorandum or Introductory Document

Documents to be Submitted After Approval In-Principle

Part VI Continuing Listing Obligations

316

Chapter 7 Continuing Obligations

Part VI Debt Securities — Continuing Listing Obligations

745

746

747

Part I Scope of Chapter

301

This Chapter applies to the listing of debt securities, such as bonds, notes and loan stocks, issued by domestic or foreign corporations, supranational bodies, governments, government agencies or any other entities, whether established in Singapore or elsewhere.

302

An issuer can seek listing of its debt securities in one of the following ways:—

continued on next page

Box A2.1 continuation

- (1) Placement or offer for sale or subscription of a new or existing issue of debt securities.
- (2) Introduction of an existing issue of debt securities. An introductory document must be issued in connection with the listing.

Part II Listing Requirements for Local Debt Securities**303**

One of the following requirements must be met for the listing of an issue of local debt securities:—

- (1) For an issuer whose equity securities are listed on the Exchange, the issue of debt securities must have a principal amount of at least \$750,000.
- (2) For an issuer whose equity securities are not listed on the Exchange: —
 - (a) The issuer must meet the Exchange's requirements in Rule 210(2), (3), (4) and (5) for listing of equity securities, and the issue of debt securities must have a principal amount of at least \$750,000; or
 - (b) The issue of debt securities must have a principal amount of at least \$750,000 and at least 80% of the issue must be subscribed by sophisticated or institutional investors; or
 - (c) The issuer must be the Government or a Singapore government agency; or
 - (d) The issue of debt securities must have a credit rating of investment grade and above.
- (3) Where the requirements in Rule 303(1) or (2) are not met, the issuer's obligations under the issue of the debt securities must be:—
 - (a) guaranteed by an entity that is listed on the Exchange and the issue of debt securities must have a principal amount of at least \$750,000; or
 - (b) guaranteed by an entity which meets the requirement in Rule 210(2), (3), (4) and (5) and the issue of debt securities must have a principal amount of at least \$750,000; or
 - (c) guaranteed by the Government or a Singapore government agency.

Part III Listing Requirements for Foreign Debt Securities**304**

One of the following requirements must be met for the listing of an issue of foreign debt securities:—

- (1) The issuer must be:—
 - (a) a supranational body; or
 - (b) a government, or a government agency whose obligations are guaranteed by a government; or
 - (c) an entity whose equity securities are listed on the Exchange; or
 - (d) a corporation which meets the following requirements:—
 - (i) Rule 210(2), (3), (4) and (5) for the listing of equity securities; or
 - (ii) A cumulative consolidated pre-tax profit of at least \$50 million for the last three years, or a minimum pre-tax profit of \$20 million for any one of the three years; and consolidated net tangible assets of at least \$50 million; or
 - (e) a corporation whose obligations under the issue of the debt securities are guaranteed by any of the entities in Rule 304(1)(a), (b), (c) or (d).
- (2) The issue of debt securities must be **at least 80% subscribed by sophisticated or institutional investors.**
- (3) The issue of debt securities must have a credit rating of investment grade and above.

continued on next page

Box A2.1 continuation

Paying Agent

305

A foreign issuer is normally required to appoint a paying agent in Singapore while the debt securities are quoted on the Exchange and upon the issue of debt securities in definitive form. The Exchange may accept other arrangements to enable definitive certificate holders of the bearer debt securities in Singapore to be paid promptly.

Release of Reports

306

If an issuer is subject to the trust deed requirements below, it must release the reports and/or financial results required in Rule 308(8)(c) and (d) via SGXNET within the period specified.

Amended on 29 September 2011.

Adjustments

307

If debt securities are:—

- (1) redeemable by the issuer, either in whole or in part, by an issue of shares; or
- (2) convertible into shares, either in whole or in part, by the holder; or
- (3) issued in conjunction with separate options to subscribe for shares,

the terms of issue of the debt securities must provide for appropriate adjustments to the conversion rights in the event of any alteration to the capital of the issuer, and whether the holders of the debt securities and/or options have any participating rights in the event of a takeover offer for the issuer.

Trustee and Trust Deed

308

- (1) An issuer **must appoint a suitable trustee** to represent the holders of its debt securities listed on the Exchange. A company which holds a trust business license under the Trust Companies Act satisfies this rule.
- (2) The trustee must have no interest in or relation to the issuer which may conflict with its role as trustee.
- (3) If the trustee ceases to perform its function, the issuer must appoint another suitable trustee.
- (4) The directors of the issuer must confirm that a suitable trustee has been appointed. The confirmation must be submitted to the Exchange prior to the issue of the debt securities.
- (5) A trust deed governing the issue of debt securities must be executed and contain the requirements in Rule 308.
- (6) Rule 308(1) to (7) does **not apply** to:—
 - (a) an issuer who has been declared a “prescribed corporation” for the purpose of Section 239(4) of the SFA.
 - (b) a debt issue that is offered only to **sophisticated or institutional investors and is traded in a minimum board lot size of SGD200,000 or its equivalent in foreign currencies** following listing.
- (7) The issuer must make all its financial and other records available for inspection by the trustee and its agent(s).
- (8) A trust deed required by Rule 308(5) must include the following provisions:—
 - (a) A limitation on the amount that the issuer or any guarantor company may borrow. For the purpose of this limitation:—

continued on next page

Box A2.1 continuation

(i) any advances made by the issuer or any guarantor company to their holding company, or to any of their subsidiaries or their holding company's subsidiaries; and

(ii) any investment by the issuer or any guarantor company in the shares of their subsidiaries or their holding company's subsidiaries,

must not be brought into account as an asset unless the company to or in which the advance or investment is made is a guarantor company and covenants with the trustee to limit itself to the same limitation of liabilities as the borrowing company.

(b) A covenant that on request in writing by the trustee, the issuer will cause any wholly-owned subsidiary (whether formed or acquired before or after the date of the Trust Deed) of the issuer to become a guarantor company. The covenant may be qualified, but must provide that the trustee is entitled:—

(i) in the case of secured debentures if the value of the security is or is believed by the trustee to have become less than the principal amount outstanding; or

(ii) in the case of debentures or unsecured notes if the ratio limiting the liabilities or borrowing for the purpose of the Trust Deed has been or is believed by the trustee to have been infringed or its maintenance is threatened,

to call upon the issuer to procure any one or more of its subsidiaries (whether formed or acquired before or after the date of the Trust Deed) to become a guarantor company.

(c) The directors of the issuer must prepare a report that relates to each quarter and lodge it with the trustee within one month of the end of the period. The report must be signed by 2 directors and state:

(i) whether or not any limitation of liabilities or borrowings as prescribed by the Trust Deed has been exceeded;

(ii) whether or not the issuer and the guarantor company have observed and performed all the covenants and obligations binding upon them respectively pursuant to the Trust Deed;

(iii) whether or not any event has happened which has caused or could cause the security created by the Trust Deed to become enforceable;

(iv) whether or not any material trading or capital loss has been sustained by the issuer or any guarantor company;

(v) whether or not any circumstances materially affecting the issuer or any guarantor company have occurred which adversely affect the debt securities;

(vi) whether any contingent liabilities have been incurred by the issuer or any guarantor company. If so, to state the amount incurred, and whether or not any contingent liability has matured or is likely to mature within the next twelve months, which will materially affect the ability of the issuer or any guarantor company to repay the debt securities;

(vii) whether or not there has been any change in any accounting method or method of valuation of assets or liabilities;

(viii) whether or not any circumstances have arisen which render adherence to the existing method of valuation of assets or liabilities misleading or inappropriate; and

(ix) any substantial change in the nature of the issuer's or any guarantor company's business since the issue of the debt securities.

(d) Within three months of the expiration of the full year and the half year, the issuer must provide the trustee the consolidated profit and loss account and balance sheet (which must be prepared in accordance with the approved accounting standards) of the issuer and of any guarantor company. The accounts relating to the full year must be audited.

(e) The directors shall notify the trustee immediately when they are aware that any condition of the Trust Deed cannot be fulfilled.

(f) A meeting of holders of debt securities must be called on a requisition in writing signed by holders of at least 10% of the nominal amount of the outstanding debt securities.

Amended on 29 September 2011.

Medium Term Note Programme

309

The principal amount of each listed series of a Medium Term Note Programme must be at least SGD5 million.

Amended on 29 September 2011.

continued on next page

Box A2.1 continuation

Part V Listing Procedures for Debt Securities

310

An applicant may consult the Exchange to resolve specific issues prior to the submission of an application. Unless the Exchange prescribes otherwise, the following sets out the usual main steps in the listing process.

- (1) The applicant submits (to the Listings Function) one copy of the listing application. The listing application comprises **the prospectus, offering memorandum or introductory document** prepared in compliance with Rules 312 to 313 and, the supporting documents set out in Rule 314. The prospectus, offering memorandum or introductory document which forms part of the listing application must be in final form;
- (2) The Exchange considers whether the application satisfies the listing requirements and will decide whether to issue an eligibility-to-list letter for listing (with or without conditions). Listing will not be permitted until all conditions set out in the eligibility letter have been satisfied;
- (3) Where a prospectus, offering memorandum or introductory document is required to be issued, the applicant lodges the prospectus, offering memorandum or introductory document with the relevant authority (if applicable) and submits a copy to the Exchange. The lodged copy of the prospectus, offering memorandum or introductory document should not be materially different from the prospectus, offering memorandum or introductory document on which the eligibility-to-list letter was issued. The applicant must submit a written confirmation to the Exchange to this effect. If there are material differences, the Exchange may withdraw the eligibility-to-list letter;
- (4) The Exchange will inform the applicant of any further information that is required to be disclosed prior to commencement of trading. The applicant decides whether to include this information in its prospectus, offering memorandum or introductory document, or to make pre-quotation disclosure through an announcement to the Exchange. Pre-quotation disclosure must be made not later than the market day before commencement of trading of the debt securities; and
- (5) On satisfaction of the conditions expressed in the eligibility-to-list letter, the issuer's debt securities will be listed and quoted on the Exchange.

Time Schedule

311

The Exchange will decide whether to issue an eligibility-to-list letter as soon as practicable after receipt of a complete application. If the applicant makes material amendments to the prospectus, offering memorandum or introductory document, the time may start to run from the date the material amendment is notified to the Exchange.

Content of Prospectus, Offering Memorandum or Introductory Document

312

If a prospectus is required, a checklist showing compliance with Part II of Chapter 6 must be provided. If, under applicable law, an application is made to the relevant government authority for any waiver or modification of any prospectus requirement, a copy of such letter must be submitted together with the prospectus.

313

If the debt securities are offered without a prospectus and primarily to sophisticated investors or institutional investors, the offering memorandum or introductory document must contain the information that such investors would customarily expect to see in such documents.

Documents to be Submitted with the Prospectus, Offering Memorandum or Introductory Document

314

Two copies of each of the documents set out below must be submitted together with the applicable listing fee. Where the debt securities are issued by an issuer whose equity securities are listed on the Exchange, or where the debt securities are offered primarily to sophisticated investors or institutional investors, the issuer need only submit the documents set out in Rule 314(5), (6), (7) and (8).

- (1) The Memorandum and Articles of Association or other constituent documents if any, incorporating all amendments to date.
- (2) Material contracts (other than those entered into in the ordinary course of business) entered into during the preceding 24 months or proposed to be entered into by the issuer and its subsidiaries with any director, controlling shareholder or their associates.

continued on next page

Box A2.1 continuation

- (3) Auditors' report to management on the internal control and accounting system of the issuer and its principal subsidiaries.
- (4) For an issuer which is engaged in property investment or development, valuation report(s) of each principal asset of the group that is revalued.
- (5) The mortgage indenture or equivalent instrument certified by the trustee.
- (6) The trust deed and a checklist showing compliance with the requirements in Rule 308(8).
- (7) Other documents, such as a deed poll, that may be applicable to the issue of debt securities.
- (8) A checklist showing compliance with the relevant requirements under Rules 303 to 309.
Amended on 29 September 2011.

Documents to be Submitted After Approval In-Principle**315**

After the issuer receives approval in-principle from the Exchange, the following documents must be submitted before the listing of the debt securities:—

- (1) The signed listing undertaking in the form set out in Appendix 2.3.1;
- (2) The signed issue documents, such as the subscription agreement, agent bank agreement and fiscal agency agreement and trust deed (as applicable);
- (3) The required number of copies of the prospectus, offering memorandum or introductory document;
- (4) A local debt issuer must also submit the following documents:—
 - (a) A copy of the “tombstone” advertisement, if one was published;
 - (b) A signed copy of the auditors' letter on the accounts in a form acceptable to the Exchange, where an accountants' report is prepared for the purpose of the issue; and
 - (c) A certified copy of any relevant resolution(s) of the shareholders and a copy of any letters of approval from the Government, if applicable;
- (5) In the case of a foreign debt issuer, the names and addresses of its representatives, with whom the Exchange may liaise in respect of future correspondence regarding the debt securities. The representatives must be easily contactable by the Exchange; and
- (6) Such other documents (if any) as stipulated in the approval in-principle letter.

Part VI Continuing Listing Obligations**316**

A debt issuer is required to observe only the continuing listing obligations in **Part VI of Chapter 7**. It must also undertake to release information to the Exchange via SGXNET at the same time as such information is released to the home market and must comply with such other rules as may be applied by the Exchange from time to time (whether before or after listing).

—

Chapter 7 Continuing Obligations**Part VI Debt Securities — Continuing Listing Obligations****745**

A debt issuer must immediately disclose to the Exchange via SGXNET any information which may have a material effect on the price or value of its debt securities or on an investor's decision whether to trade in such debt securities.

continued on next page

Box A2.1 continuation

746

A debt issuer must provide the Exchange with the required number of copies of its published annual report (in English) and all documents annexed thereto as soon as it is issued.

747

A debt issuer must announce: —

- (1) any redemption or cancellation of the debt securities;
- (2) the details of any interest payment(s) to be made (except for fixed rate notes listed solely on the Bonds Market).
- (3) any amendments to the Trust Deed; and
- (4) any appointment of a replacement trustee as required by Rule 308(3).

Note: Emphases added by author.

Source: Attorney-General's Chamber; Singapore Exchange.

Thailand

Bond Market Guide

Contents

Acknowledgement	vii
I. Structure, Type, and Characteristics of the Market	1
A. Overview	1
B. Types of Bonds	2
C. Money Market Instruments	6
D. Segmentation of the Market	6
E. Listing of Debt Securities	7
F. Methods of Issuing Bonds (Primary Market)	7
G. Public Offering and Private Placement Markets	8
H. Wholesale and Retail Investors	16
I. Definition of Professionals and Professional Investors	17
J. Definition of Qualified Institutional Investors	17
K. Credit Rating System	18
L. Related Systems for Investor Protection	19
M. Governing Laws on Bond Issuance	24
N. Transfers of Interests in Bonds	24
O. Definition of Securities	25
P. Self-Governing Rules behind the Market	26
Q. Bankruptcy Procedures	27
R. Bondholder Representative	28
S. Event of Default	28
T. Major Market Participants	29
U. Degree of Opening of Domestic Bond Markets to Foreign Investors and/or Issuers	29
V. ASEAN Bond Market Development Scorecard (Revised): Thailand	30
Primary and Secondary Market Regulatory Frameworks	33
A. Rules and Regulations in the Thai Market Regulatory Structure	33
B. Securities Issuance Rules in Brief	38
C. Filing and Approval Criteria	41
D. Bond Electronic Exchange's Rules Related to Bond Listing, Disclosure, and Trading	48
E. Thai Bond Market Association's Rules related to Trading, Reporting, and Registration	48
F. Bank of Thailand's Regulations on Non-resident	48

G. Credit Rating Requirements	48
H. Exemptions for Private Issues (Private Placement)	49
I. Minimum Lead Time for Registration Approval	49
J. Availability of Shelf Registration and Associated Documentation Requirements.....	49
K. Regulated Suspension Period	49
L. Other Requirements	49
M. Continuous Disclosure Rules or Requirements	49
N. Restrictions for Investors	50
O. Non-Resident Requirements and Restrictions	50
P. Taxation Framework and Requirements	51
III. Trading of Bonds and Trading Market Infrastructure.....	54
A. Trading of Bonds.....	54
B. Trading Platforms.....	55
C. Bond Information Center.....	56
D. Government Bond Yield Curve and Bond Indices	57
E. Bond Futures.....	58
F. Repo Transactions	58
IV. Possible Items for Future Improvements.....	59
A. Impediments to the Thai Bond Market.....	59
B. Significant Factors.....	59
V. Description of the Securities Settlement System.....	61
A. Securities Settlement Infrastructure	61
B. Bond Settlement Infrastructure Diagram (Thailand)	64
C. Brief History of the Development of the Securities Settlement Infrastructure	64
D. Business Process Flowchart in the Thailand Over-the-Counter/Delivery Versus Payment Bond Market	65
E. Thailand Bond Transaction Flow for Foreign Investors	65
F. Role of the Thailand Clearing House.....	67
G. Definition of Clearing, Settlement and Assessment	67
H. Challenges and Future Direction	69
VI. Cost and Charging Methods.....	70
A. Average Issuing and Trading Costs for Corporate Bonds and Commercial Papers	70
B. Average Ongoing Costs for Corporate Bonds and Commercial Papers	71
VII. Market Size and Statistics	73
A. Nature and Size of the Thai Bond Market	73
B. Size of Local Currency Bond Market	75
C. Size of Local Currency Bond Market in Percentage of Gross Domestic Product.....	77
D. Size of Foreign Currency Bond Market in Percentage of Gross Domestic Product, Bank for International Settlement	78
E. Size of Foreign Currency Bond Market, Local Sources.....	79
F. Issuance Volume of Local Currency Bond Market	80
G. Foreign Holdings in Local Currency Government Bonds.....	82
H. Domestic Financing Profile.....	83
I. Trading Volume.....	83

VIII. Presence of an Islamic Finance (Islamic Bond [Sukuk]) Market	85
A. Current Development of an Islamic Bond Market in Thailand	85
B. Regulations on Plain Vanilla Sukuk	85
C. Specific Regulation on Sukuk.....	85
D. Infrastructure for Sukuk.....	85
IX. Brief History of Debt Market Development.....	86
A. Measures for Bond Market Development	86
X. Next Steps ⇨ Future Direction	87
A. Capital Market Master Plan (2002)	87
B. Capital Market Master Plan II (2006).....	87
C. Capital Market Masterplan (2009)	88
D. Future Direction	92
E. Group of 30 Compliance	92
F. Group of Experts Barrier Report Market Assessment – Thailand (April/2010).....	93
Appendixes	95
Appendix 1. “Survey on Primary Market Questions for IOSCO Jurisdictions”.....	95
Appendix 2. ASEAN Bond Market Development Scorecard: Thailand.....	99
Appendix 3. ASEAN Bond Market Development Scorecard: ASEAN.....	102
Appendix 4. Scorecard-Related Explanation	104
References	108

Boxes, Figures, and Tables

Boxes

Box 1.1	Characteristics of Private Placements	9
Box 1.2	Definition of Institutional Investors and High Net Worth Investors.....	11
Box 1.3	Chapter XI of the Public Limited Companies Act.....	12
Box 1.4	Summary of Permission to Issue Baht-Denominated Bonds or Debentures by Foreign Entities in Thailand No. 42/2006 (3 May 2006)	15
Box 2.1	Securities Issuance	38
Box 2.2	Notification on Characteristics of Private Placement/Exempt Rule	45
Box 2.3	Notification on Exemption from Filing of Registration Statement for the Offer for Sale of Debt Securities	47
Box 3.1	Excerpt from Primary to Secondary Market Description by the International Monetary Fund	54
Box A1.	Survey on Primary Market Questions for IOSCO Jurisdictions.....	95

Figures

Figure 3.1	Screenshot of Intraday Trading Information	56
Figure 3.2	ThaiBMA Government Bond Yield Curve as of 17 June 2011	57
Figure 3.3	ThaiBMA Government Bond Index	58
Figure 5.1	Thai Bond Infrastructure Diagram.....	64
Figure 5.2	Business Process Flowchart in the Thailand Over-the-Counter/Delivery Versus Payment Bond Market....	65
Figure 5.3	Thailand Bond Transaction Flow for Foreign Investors	66

Tables

Table 1.1	Segmentation of the Market: Outstanding Value by Type of Issuers ^a (THB billion).....	6
Table 1.2	ThaiBMA Monthly Summary of Investments in the Bond Market (August 2011 and November 2011)	13
Table 1.3	Extract and Summary of Approval and Filing of Bonds in Thailand	14
Table 1.4	Summary of Credit Rating System	18
Table 1.5	Summary of ASEAN Bond Market Development Scorecard for Thailand	30
Table 2.1	Filing and Approval Criteria for Plain Debt.....	41
Table 2.2	Filing and Approval Criteria for Plain Debt and Complex Debt	42
Table 2.3	Regimes in the Thai Bond Market	43
Table 2.4	Minimum Lead Time for Registration Approval	43
Table 2.5	Regulations on Corporate Bond Offering	43
Table 2.6	Long-Term Foreign Currency Ratings	48
Table 2.7	Duties and Tax on Dividends and Fixed Income.....	51
Table 2.8	Summary of Taxation Framework and Tax Requirements in Thailand	53
Table 4.1	Factors Inhibiting the Development of the Corporate Bond Market in Thailand	60
Table 5.1	Information on Post-Trade Integrated (as of 31 January 2008)	63
Table 6.1	Transfer Fees for Government Bonds and Other Securities	70
Table 6.2	Brokerage/Commission Fees on Securities Transactions	71
Table 6.3	Maintaining of Securities Depository Account Fee	71
Table 7.1	Size of the Market for Debt Instruments, 2009.....	73
Table 7.2	Data for Corporate Bond by Type of Issue (USD million).....	73
Table 7.3	Total Corporate Bond Trades in the Secondary Market, 2005–2009	74
Table 7.4	Size of the Market per Type of Bonds, 2009	74
Table 7.5	Main Buyers in the Corporate Bond Market.....	74
Table 7.6	Size of Thailand Financial Market, 2002-2010.....	75
Table 7.7	Thailand Bond Market Association Outright Trading and Outstanding Value, 2009–2010 (THB million)	75
Table 7.8	Size of Local Currency Bond Market, Local Sources (USD billion).....	75
Table 7.9	Size of Local Currency Bond Market in Percentage of Gross Domestic Product, Local Sources	77
Table 7.10	Foreign Currency Bonds to Gross Domestic Product Ratio.....	78
Table 7.11	Foreign Currency Bonds Outstanding, Local Sources (USD billion)	79
Table 7.12	Issuance Volume of Local Currency Bond Market (USD billion)	80
Table 7.13	Foreign Holdings in Local Currency Government Bonds (THB billion).....	82
Table 7.14	Domestic Financing Profile	83
Table 7.15	Trading Volume (USD billion)	83
Table 10.1	Group of Thirty Compliance Recommendations.....	93
Table 10.2	Group of Experts Barrier Report Market Assessment – Thailand	93
Table A1.1	ASEAN Bond Market Development Scorecard: Thailand.....	99
Table A1.2	ASEAN Bond Market Development Scorecard: ASEAN	102

Acknowledgement

The Asian Development Bank (ADB) Team, comprising Satoru Yamadera (Economist, ADB Office of Regional Economic Integration, - September 2011), Seung Jae Lee (Principal Financial Sector Specialist), Shinji Kawai (Senior Financial Sector Specialist, Banking), Shigehito Inukai (ADB consultant), Taiji Inui (ADB consultant), and Matthias Schmidt (ADB consultant), would like to express their sincere gratitude to national members and expert institutions: Bank of Thailand (BOT), Securities and Exchange Commission (SEC), Thai Bond Market Association (Thai BMA), Stock Exchange of Thailand (SET), Thai Securities Depository (TSD), and Thai Clearing House (TCH). They kindly provided answers to the questionnaires prepared by the ADB team, thoroughly reviewed the draft of Market Guide, and gave their valuable comments.

The ADB team also would like to express special thanks to Citibank, Deutsche Bank AG, The Hongkong and Shanghai Banking Corporation, J.P. Morgan, and State Street for their contribution as international experts in providing information from their respective market guides, as well as their valuable expertise. Because of their cooperation and contribution, the ADB Team started their research on solid ground.

Last but not least, the Team would like to thank all the interviewees who gave their comments and responses to questions during the market consultations.

It should be noted that any part of this report does not represent the official views and opinions of any institution which participated in this activity as ABMF members and experts. The ADB Team bears responsibility for the contents of this report.

February 2012

Asian Development Bank (ADB) Team

List of Interviewees:

Bangkok, 12 May 2011

Bank of Thailand (BOT)

The Hongkong and Shanghai Banking Corporation, Bangkok

Standard Chartered Bank, Bangkok

Bangkok, 13 May 2011

Securities and Exchange Commission (SEC)

Siam Premier Law Firm

Thai Bond Market Association (ThaiBMA)

Stock Exchange of Thailand (SET)

Thai Securities Depository (TSD)

Thai Clearing House (TCH)

I. Structure, Type, and Characteristics of the Market

Thailand's bond market has developed significantly since the 1997–1998 Asian financial crisis, with increased bond issuance and an actively traded local market. The Ministry of Finance (MOF) has stepped up issuance of government bonds for its financing requirements and built a reliable yield curve in support of market-risk pricing. Government bonds still dominate the market. Since the late 1990s, both government and corporate issuers have used bonds to raise capital. However, the issues are generally straight fixed-rate or floating-rate notes. The structured bond market is still in the early stages of development.

A. Overview¹

1. Background

The Thai bond market has experienced rapid growth in recent years after the 1997 economic crisis. To help support cash-strapped financial institutions, the government issued government bonds for the first time in June 1998. The total amount of government bonds issued under that program was THB500 billion, which opened a new era for the Thai bond market.

The government continued to issue bonds since then with the primary objective to finance the budget deficit in each financial year, or when the expenditures exceeded the revenue, to support social and economic development and to restructure public debt.² The substantial amount of new government bonds coupled with the successive downtrend of interest rates have contributed to the robustness of the bond market as evidenced by a significant increase in both market size and trading volume. Government bonds still dominate the market, making up about 80% of all bonds issued. With the introduction of regulations governing corporate bond issuance, a variety of issuers have entered the market, including multinationals, supranational, and local companies.

¹ An overview of the bond market in Thailand can be found in the Thailand Bond Market Association website, <http://www.thaibma.or.th/main.html> and in International Monetary Fund (IMF). 2009. *Thailand: Financial Sector Assessment Program—Technical Note—Fixed Income Markets*. IMF Country Report No. 09/151. <http://www.imf.org/external/pubs/ft/scr/2009/cr09151.pdf>

² Bank of Thailand (BOT). <http://www.bot.or.th/English/FinancialMarkets/IntroductionToGovernmentDebtSecurities/InterestingContent/Pages/Type.aspx>

Foreign issuers may now also issue bonds, in line with a new regulatory framework promulgated by the Securities and Exchange Commission (SEC).

Both government and corporate bonds are available with tax waivers to foreign investors. Bond trading is conducted either over the counter (OTC) or via the Bond Electronic Exchange (BEX) for retail bonds, which was established by the Stock Exchange of Thailand (SET) in November 2003. All trades (both OTC and on the exchange) are reported to the Thai Bond Market Association (ThaiBMA) within 30 minutes of execution. Trade prices and details are then disseminated by the ThaiBMA through a number of channels, including via the Daily Market Summary on its website.³

2. Regulatory Environment

The Bank of Thailand (BOT) supervises the operation of banking and finance businesses while the SEC supervises the primary and secondary market for securities business. The issuance and offering of securities are governed by the *Securities and Exchange Act 1992* (B.E. 2535).

In November 1994, the Bond Dealers Club (BDC) was set up to be the secondary market for debt securities. The BDC was upgraded to the Thai Bond Dealing Centre (Thai BDC) in April 1998 after it was granted the Bond Exchange license from the SEC.

The goals of the Thai BDC were to provide an environment for fair and secure trading, to monitor trade, and to disseminate information on the secondary bond market. It also functioned as a self-regulatory organization (SRO) and implemented a number of standards and conventions for bond trading. It continuously expanded its functions and took active roles in various area of bond market development.

In December 2004, the Bond Market Development Committee chaired by the Finance Minister initiated a major reform of the Thai bond market. One of the measures was to centralize the trading platform at the SET while ThaiBDC would remain and expand its functions as the SRO and information center for the bond market. Under this policy, ThaiBDC sold its newly developed electronic trading platform to the SET in 2005. To reiterate its focus on SRO functions and as an information center, ThaiBDC, with support from the SEC, changed its status and was granted the license of a securities-related association under the SEC Act and was named “The Thai Bond Market Association (ThaiBMA)” on 8 September 2005. In addition to its governance functions, ThaiBMA also acts as a bond pricing agency, providing model yield and pricing data for the mark-to-market purpose of investors such as mutual funds. This is deemed very useful in the case of illiquid debts securities.

B. Types of Bonds

Products in the Thai bond market are stated as follows.

³ Thailand Bond Market Association (ThaiBMA). www.thaibma.or.th/compositerpt/dailyreport.aspx

1. Thai Government Debt Securities

The Thai Government Debt Securities (TGSs) are securities issued by the Thai government.

The MOF is legally authorized to act as bond issuer for fund mobilization from investors and the general public to fund public expenditures such as the budget deficit, losses incurred by the Financial Institutions Development Fund, refinancing, and infrastructure funding. In 2005, MOF revised the *Public Debt Management Act* (B.E. 2548, 2005) to allow government to issue government bonds for two additional purposes: to on-lend to other government agencies and to develop the domestic bond market.

Government securities, which may also be traded through the BEX, settle on a gross, trade-by-trade basis via the Post Trade Integration (PTI) system. The timing of the settlement process varies according to whether the trade was executed through the Automated Order Matching (AOM) system or the Put-Through (PT) system for large-lot trades valued greater than B3 million. For AOM trades, the Thai Securities Depository (TSD) checks to ensure there are securities available in the selling member's account by settlement date (SD) 1:30 p.m. The TSD prepares and sends payment details to the BOT. The BOT receives the payment details, credits or debits custodian banks' cash accounts, and generates a confirmation of debits or credits to the TSD. Once the TSD receives the confirmation between 1:30 p.m. and 2:00 p.m., confirmation from the BOT, the TSD immediately credits or debits securities to or from the member accounts in the PTI system. For PT trades, the process is essentially the same. However, availability of securities for delivery is assessed at 10:00 a.m. and securities are credited or debited between 10:00 a.m. and 11:00 a.m.

The TGSs currently issued can be classified into two main groups: Treasury bills and government bonds.

a. Treasury Bills

Treasury bills (T-bill) refer to debt securities with maturity not longer than 1 year. Currently, the government makes short-term borrowing by auction of T-bills with maturity periods of 1, 3 and 6 months with auction size of THB2,000 to THB10,000 million. Bearing no interest, they are auctioned at a discount but redeemed at par value at maturity. T-bills are issued in minimum denominations of THB1,000 through competitive bidding via the BOT on a weekly or fortnightly basis (basically every Monday), depending on the demand for short-term capital.

b. Government Bonds

Thai government bonds (TGBs) are generally issued for a fixed term longer than 1 year. According to the *Public Debt Management Act* (B.E. 2548, 2005), bonds are defined as debt instruments pertaining to a long-term obligation of over 12 months. TGBs are usually denominated in units of THB1,000.

There are three groups of issuing bodies of government securities namely the MOF, BOT, and state-owned enterprises (SOEs). Meanwhile, there are four types of government securities: 1) T-bills, 2) government bonds such as loan bonds (LB) and saving bonds (SB), 3) state-agency (SA) bonds (i.e., BOT bonds), and 4) SOE bonds.

Government bonds (except for the 4-year floating-rate bonds that began to be issued in May 2009) are bonds with fixed-rate coupons. The interest rate payment will be calculated semi-annually and the principal amount is repaid once at maturity. Generally, they can be categorized into two main characters: investment bonds or loan bonds and saving bonds.

i. Loan Bonds

LBs are bonds that target institutional investors. The Thai government has issued LBs with maturities between 1 to 30 years, of which 5- and 10-year bonds are issued as benchmark bonds to increase liquidity in the secondary market. The auction is held every Wednesday.

During the 2009 fiscal year, the Public Debt Management Office (PDMO) issued 5-year benchmark bonds with auction size of THB10,000 to THB15,000 million every even month and 10-year benchmark bonds with auction size of THB10,000 to THB13,000 million every odd month. In addition, 15- and 20-year bonds were issued regularly to create reference rates for the domestic bond market and to match the investment portfolio of long-term investors.

Since 2008, 30-year bonds, which are aimed at insurance companies, have been issued.

The main objective of the 30-year bonds is to decrease the mismatch of insurance companies' portfolios. During the start-up period, the size of these bonds is reasonably small as part of the price-discovery process to get full market competition in the future. In the long run, the government plans to use these 30-year bonds as instruments for relatively large project funding.

On 29 May 2009, the PDMO issued the 4-year Floating Rate Bond (FRB) for the first time, which has a variable coupon rate equal to the Bangkok Interbank Offered Rate (BIBOR) in addition to a spread. A spread is a rate that remains constant. Since then, the Thai government has been issuing the FRB regularly.⁴ The interest rate payment is calculated semi-annually by fixing the BIBOR for that particular day and adding the spread. The principal amount is repaid once at maturity.

ii. Saving Bonds

SBs are government bonds that target retail investors. Each investor is allowed to purchase a minimum of THB10,000, with the total value purchased to be in multiples of THB10,000. In most issues, retail investors are allowed to submit one purchase subscription for each tranche with a maximum investment of THB500,000. Interest on the bonds is paid at a fixed rate twice a year.

Eligible buyers include individuals who are Thai nationals or residents, and non-profit institutions such as foundations, the Thai Red Cross Society, and the National Council on Social Welfare of Thailand. The savings bonds are sold through selling

⁴ BankofThailand.http://www.bot.or.th/English/FinancialMarkets/BondProfile/DebtSecuritiesOutstanding/Pages/DebtSecuritiesOutstanding_GovtBonds.aspx and <http://www.bot.or.th/English/FinancialMarkets/IntroductionToGovernmentDebtSecurities/InterestingContent/Pages/Type.aspx>; PublicDebtManagement Office. <http://www.pdmo.go.th/en/about.php?m=about>

agents appointed by the MOF such as commercial banks and government saving banks, while the BOT is responsible for supervising the sales, ownership registration, and issuing the physical bond certificate.

2. Corporate Bonds

Generally, corporate bonds are traded OTC or through the BEX. For some time now, clearing and settlement are facilitated by the TSD's Post-Trade Infrastructure (PTI). Bond transactions are pre-matched by telephone and settlement occurs via the PTI system, following the same process as equities. However, unlike equities, settlement of bonds occurs on T+2.

The more commonly traded unlisted debt issues are bills of exchange (BEs). Settlement details for BEs are negotiated between counterparties. Authentication is a critical component of the settlement process of unlisted debt, as no standardized treatment for settlement exists.

Payment is made by check or through BAHTNET, subsequent to the sub-custodian's verification that the BEs or Negotiable Certificates of Deposit (NCDs) have been received in good form and are authentic.

Corporate bonds comprise of:

- (a) Long-term corporate bonds, which are bonds issued by the corporate sector with tenors of 1 year and over.
- (b) Commercial papers (CPs), which are short-term debt instruments including BEs and short-term debentures. Normally, a commercial paper has maturity of less than 270 days.
- (c) Structured bonds with the following features:
 - (i) The amount of return is linked with a predetermined underlying variable other than interest rate.
 - (ii) Total or partial amount for principal is linked with a predetermined underlying variable, e.g., equity price or index, gold price, and foreign exchange, commodity price or index, and credit rating.
- (d) Foreign Bonds.

Since 2005, MOF has allowed certain types of foreign institutions to issue baht-denominated bonds in Thailand. They include international financial institutions, foreign governments, financial institutions of foreign governments, and foreign entities, e.g., ADB, Japan Bank for International Cooperation, and Kreditanstalt für Wiederaufbau (KfW).

- (e) Foreign-Denominated Bonds

In 2010, Thai entities were allowed to issue bonds in foreign currency. Currently, there is only one company issuing this type of bonds.

C. Money Market Instruments

Money market instruments are traded in the OTC market and settled by physical delivery. There are various money market instruments traded in Thai capital market. These include:

(a) Promissory Notes

Promissory notes (PNs) are physical, bearer instruments issued by banks and other financial institutions. PNs are issued on a discounted basis with tenures ranging from 1 month to 1 year.

(b) Bills of Exchange

BEs are similar to checks and PNs, which sometimes are referred to as a “draft.” They can be drawn by individuals or banks and are generally transferable by endorsements. The difference between a PN and a BE is that BE is transferable and can bind one party to pay a third party that was not involved in its creation.

(c) Commercial Papers

CPs are short-term unsecured notes issued by corporations. The maturity of CPs is less than 270 days. The most common form of CP is taking the format of BEs, which are short-term Thai baht-denominated interest-bearing or discounted instruments. BEs are issued in bearer or registered form by banks, companies, and other financial institutions. Typical issue sizes range from THB5 million to THB250 million with varied tenures, i.e., between 1 month to 1 year.

(d) Time Deposits

Time deposits represent cash placed with a bank or financial institution for a fixed period, in return for a fixed or variable interest rate. Typical tenors are from one month to 2 or 3 years. In Thailand, time deposits are guaranteed by the government.

D. Segmentation of the Market

Table 1.1 Segmentation of the Market: Outstanding Value by Type of Issuers^a
(THB billion)

	Type of Bond	Outstanding as of November 30, 2011	%
Government Debt Securities	Treasury Bill	0.00	0.00
	Government bond	2,629.50	37.42
	State-owned enterprise bond (SOE)	481.66	6.85
	State agency bond (SA) (i.e., Bank of Thailand bond)	2,587.83	36.83
	Sub-Total	(5,698.99)	(81.10)
Corporate Debt Securities	Corporate bond	1,149.70	16.36
	Commercial paper	98.79	1.41
	Sub-Total	(1,248.49)	(17.77)
Foreign Bond		79.69	1.13
Total		7,027.17	100.00

^a As of end of November 2011.

Source: ThaiBMA, Historical ThaiBMA Monthly Summary Nov 2011. Thai Bond Market Association (TBMA). http://www.thaibma.or.th/disclaimer/Sitemap_ThaiBMA.html

More information can be found in Appendix 1.

E. Listing of Debt Securities

1. Listed Securities

Listed securities are debt instruments listed, or authorized to be traded, on the Exchange (SET or BEX). The issuer should get approval from the Exchange for listing. All publicly offered government and corporate bonds are listed in Thailand. However, this is not an SEC requirement. The SEC actually rules that all bonds issued as private placements (PP) or public offers (PO) must be registered with ThaiBMA with exception for bonds with very limited distribution (e.g., offered to less than 10 investors). For more information, SET/BEX's rules related to bond listing can be found in the SET website.⁵

2. Stock Exchange of Thailand/Bond Electronic Exchange Listed and Publicly Offered Bonds

Information regarding periodic interest rates, frequency of coupon payments, term to maturity, par value of the bond, redemption value of the bond, and any other provisions are all stated in the prospectus when a bond is issued. Once a bond is auctioned in the primary market, the bond can be electronically traded in the secondary market through the BEX.

There are several names associated with bonds, such as debt instrument, fixed-income instrument, debenture, etc. Investors (mainly retail investors) can buy or sell bonds in the BEX, which was officially launched on 26 November 2003. BEX's primary goal is to develop all facets of the Thai bond market to reach an international standard, on par with other mature bond markets. In addition, instituting an electronic trading platform like BEX is a progress towards creating a vibrant Asian bond market, whose development and advancement would contribute to the stabilization of the regional economy.

The Thai bond market is OTC focused, wherein 95% of trades are OTC based.

F. Methods of Issuing Bonds (Primary Market)

1. Bond Issuance Procedure

Once an issuer decides to issue bonds, a financial advisor will be appointed to provide an opinion on the type, conditions, and other relevant details of bond issuance. The financial advisor helps in preparing all the necessary documents regarding the bonds being issued to obtain SEC's permission. The advisor will then have the bond rated by one of the two SEC-approved rating agencies. Rating is mandatory in Thailand.

In addition, the company must appoint an underwriter who will allocate the bond to investors after receiving SEC's approval. In some cases, issuers may decide to go through the process without the help of a financial advisor or an underwriter.

⁵ Stock Exchange of Thailand (SET). <http://www.set.or.th/set/notification.do?idLv1=7&idLv2=57&language=en&country=US>; "Listing of Debt Instruments as Listed Securities," Regulations of the Stock Market of Thailand, http://www.set.or.th/en/products/bonds/bonds_p1.html; Extracts from "Background of Thai Bond Market," http://www.set.or.th/en/products/bonds/files/bond_knowledge_eng.pdf

2. Method of Government Securities Offering

Most government securities are issued through the auction method, except for SOE bonds which are offered through underwriters. Units which run the auction for government securities are the BOT and PDMO. The BOT is responsible for the auction of T-Bills, LBs, and BOT bonds while PDMO is responsible for SOE bonds in both categories, with and without government guarantee.

The BOT set up a bidding system for government securities comprising two types:

- a. **Competitive Bidding.** Eligible participants are required to submit a bidding form through an electronic channel (e-Bidding) by 9:30 a.m. on the auction date. A bidder should indicate the desirable size and yield with a minimum amount of THB100 million.
- b. **Non-Competitive Bidding.** Those who are interested in non-competitive bidding have to submit subscription forms to primary dealers by 12:00 noon on a day prior to the auction date. The primary dealer then gathers all the forms and submits to the BOT by 2:00 p.m. on the same day. Bidders indicate only the size they prefer to take which should be between THB4 million to THB40 million. Non-competitive bidding is limited to certain types of investors, such as non-profit organization, foundation, and savings cooperatives.

Regarding SOE bond auction, the PDMO usually calls for bids among underwriters on a full commitment basis. Bidders should submit an underwriting proposal detailing yields, fees and all other expenses together with the names of related parties. The bidding result is posted on the PDMO website at approximately 11:00 a.m. on the auction date. SOE bonds are offered through an underwriting mechanism.

3. Corporate Bond Offering Method

Bond offering in the private sector is divided into two categories: public offering (PO) and private placement (PP) offering. Corporate bonds are usually sold through the underwriting process.

4. Approval for the Offering of Newly Issued Securities

Division 1 of Chapter 2 on the “Issuance of Securities” of the SEC Act provides for the approval for the offering of newly issued securities.⁶

G. Public Offering and Private Placement Markets

1. Types of Bond Offerings

There are two types of bond offerings.

a. Private Placement (PP)

The first type is PP, where the offer is made to 1) institutional investors or high net worth investors or 2) to a maximum of 10 investors within any four-month period, as further prescribed by the SEC Rules detailed in Box 1.1. These conditions are also applied to the secondary market as any transfer must comply with the offer conditions.

⁶ Securities and Exchange Commission (SEC). http://www.sec.or.th/laws_notification/Content_0000000312.jsp?categoryID=CAT0000015&lang=en

A bond offered through PP is negotiated and traded off the Exchange floor, referred to as OTC.

Box 1.1 Characteristics of Private Placement^a

Notification of the Capital Market Supervisory Board No. TorChor. 9/2552

Re: Application for and Approval of Offer for Sale of Newly Issued Debt Securities

Chapter 2 Private Placement of Debt Securities

Division 1 Characteristics of Private Placement

Clause 32 An offer for sale of bonds in any of the following manners shall be deemed private placement:

(1) An offer made to institutional investors or high net worth investors, excluding an offer made to institutional investors or high net worth investors with registration of transfer restriction among not exceeding ten investors within any four-month period which shall fall under (2);

(2) An offer made specifically to not exceeding ten investors within any four-month period;

In cases where the securities depository center, custodian, securities broker, securities dealer or any person holds bonds on behalf of other persons, the counting of the number of investors under the first paragraph shall be based on the real owner of such bonds.

(3) An offer made to the person being the company's creditor prior to the offer for sale of bonds for the purpose of debt restructuring;

(4) An offer granted an exemption from the Office, where the approved person shall demonstrate that:

- (a) There is reasonable and appropriate cause;
- (b) Such offer for sale shall not affect investors at large; and
- (c) There are sufficient measures for investor protection.

Clause 33 In case of requesting an exemption for an offer for sale of newly issued bonds under Clause 32(4), the person requesting an exemption shall demonstrate the reasonable and appropriate cause of such case, the non-existence of effects on investors at large and the availability of sufficient measures for investor protection, and the Office may grant an exemption for application of the rules or conditions prescribed in this Chapter, whether totally or partially, to such offer for sale of bonds as deemed necessary, by taking into account the suitability and sufficiency of measures for investor protection.

Clause 34 Bills issued in any of the following manners shall be deemed issuance of bills for private placement:

(1) Bills issued by the securities finance institution or any other person as specified by the Office with the purpose to borrow money from institutional investors or high net worth investors;

(2) Short-term bills offered to institutional investors or high net worth investors;

(3) Bills which do not fall under (1) or (2) in the amount of not exceeding ten bills at any time when counting all types of bills issued by the company.

For the purpose of the provisions in this Clause, the term "institutional investor" under the first paragraph shall not include the persons prescribed in Clause 5(3) of the Notification of the Securities and Exchange Commission No. KorChor. 4/2552 Re: Exemption from Filing of Registration Statement for Offer for Sale of Debt Securities dated 13 March 2009.

Division 3 After-Approval Conditions for Private Placement of Debt Securities

Clause 37 In case of an offer for sale of all types of newly issued debt securities to institutional investors established under Thai law or high net worth investors under Clause 32(1), the approved person shall comply with the conditions under Clause 38, Clause 39 and Clause 40.

Clause 38 Prior to each offer for sale of newly issued debt securities, the approved person shall provide any of the following credit rating arrangement by the credit rating agency approved by the Office:

(1) Credit rating of debt securities offered for sale each time (issue rating);

(2) Credit rating of the debt securities guarantor (guarantor rating), only in cases where the guarantor is obliged to liabilities jointly with the debtor without revocability before the debt securities maturity, including credit rating of the provider of aval of principle and interest of bills in full amount without condition; or

continued on next page

Box 1.1 continuation

(3) Credit rating of the approved person (issuer rating), excluding the case of an offer for sale of subordinated bonds.

The provisions related to granting of exemption for credit rating arrangement as prescribed in the second paragraph of Clause 21 shall also apply to the case under the first paragraph.

Clause 39 After the issuance of debt securities, the approved person shall provide continuous arrangement of credit rating of debt securities in accordance with the rules under Clause 38 until the claim for repayment of such debt securities is terminated. Except where it is necessary and appropriate, the Office may grant an exemption for arrangement of credit rating of debt securities and may also prescribe the timeframe or conditions thereof, by taking into consideration the necessity of credit rating information for investors.

Clause 40 The approved person shall file an application with the Thai Bond Market Association for registration of the issued and offered debt securities within thirty days after the issuing date.

Clause 41 In case of an offer for sale of short-term bonds or bills to institutional investors or high net worth investors, the approved person may make unlimited offer for sale of short-term bonds or bills subject to the registration statement filed for an offer for sale of short-term bonds or bills to institutional investors or high net worth investors as prescribed in the Notification of the Capital Market Supervisory Board concerning filing of registration statement for offer for sale of debt securities, but any offer shall be made within one year after the effective date of such registration statement.

Division 4 Additional After-Approval Conditions for Private Placement of Bonds

Clause 42 Prior to an offer for sale of bonds, the approved person shall obtain an explicit resolution from the company's board of directors approving the issuance of bonds. Except where the applicant is a public limited company, the resolution for the issuance of bonds shall be obtained in compliance with the law on public limited company.

The provisions in the first paragraph shall not apply to the case where the company is required to issue bonds according to the rehabilitation plan under the bankruptcy law which has been approved by the court, or any other case granted an exemption by the Office.

Clause 43 In case of secured bonds or bonds provided with the bond holder representative, the approved person shall provide the bond holder representative whose name is in the list of persons qualified to be the bond holder representative in accordance with the Notification concerning qualifications of bond holder representative and authority of bond holder representative.

Clause 44 The approved person shall take the following actions:

(1) Having the bonds to be issued and offered for sale meet the following characteristics:

(a) Being registered bonds and having a statement in the certificate of bonds offered for sale each time that the bond issuer shall not accept transfer registration of bonds in any level if such transfer is inconsistent with the transfer restriction as indicated and registered with the Office;

(b) Having the characteristics in accordance with Clause 17(1), (2) and (3);

(c) Complying with the rules prescribed in Clause 18 and Clause 19 in case of an offer for sale of subordinated bonds or perpetual bonds, as the case may be;

(d) In case of an offer for sale of bonds to institutional investors established under Thai law or high net worth investors under Clause 32(1), having the terms and conditions with at least the particulars as prescribed in Section 42(1) to (9) and complying with the first paragraph of Clause 29;

(2) In case of private placement of bonds under Clause 32(2), (3) or (4), the approved person shall not advertize an offer for sale of newly issued bonds and reserved shares. If the distribution of offer documents is made, the approved person shall distribute such documents only to persons with the characteristics or in the limited number as prescribed in Clause 32(2), (3) or (4) as granted approval;

(3) Offer documents (if any) shall contain a statement indicating the transfer restriction under (1)(a) and in case of an offer for sale of subordinated bonds, such subordination shall be clearly indicated.

Clause 45 In cases where any person shows his intention to the approved person to register transfer of bonds, the approved person shall make verification of such transfer. If such transfer is inconsistent with the transfer restriction registered with the Office, the approved person shall not register such transfer, except for transfer by inheritance.

In cases where the approved person has provided the bond registrar, the approved person shall have the bond registrar comply with the rules prescribed in the first paragraph.

Division 5 Additional After-Approval Conditions for Private Placement of Bills

Clause 46 Prior to an offer for sale of bills, the approved person shall obtain an explicit resolution from the company's board of directors approving the issuance of bills, except for the case where the company is required to issue bills according to the rehabilitation plan under the bankruptcy law which has been approved by the court or any other case granted an exemption by the Office.

continued on next page

Box 1.1 continuation

Clause 47 The approved person shall provide a statement that “These bills are securities and approved for private placement” on the face of the bills. In case of the issuance of bills under Clause 34(1) or (2), the bill issuer shall provide additional statements saying “Being offered for sale only to institutional investors or high net worth investors” and “Non-negotiable” or “With the purpose of transfer among institutional investors or high net worth investors” or any other statement with similar meaning.

Clause 48 In case of an offer for sale of bills under Clause 34(3), the approved person shall not advertise such offer. If the distribution of offer documents is made, the approved person shall distribute such documents only to persons with the characteristics or in the limited number as prescribed in Clause 34(3) as granted approval.

Notified this 13th day of March 2009.

Remark: The rationale for issuing this Notification is to prescribe rules on approval of an offer for sale of newly issued debt securities by a company established under Thai law or a branch of a foreign commercial bank and, so as to promote development and growth of Thai debt securities market, to relax rules on approval of an offer for sale of debt securities to limited group of investors which will help facilitate fund raising through debt securities issuance of the private sector, as well as to re-define an offer for sale to limited group of investors to include an offer for sale of debt securities to institutional investors or high net worth investors without limitation of offer value to be in accordance with international standards.

^a Emphases added by authors.

Source: Securities and Exchange Commission. Footnote 8. <http://capital.sec.or.th/webapp/nrs/data/4607se.pdf>

Box 1.2 Definition of Institutional Investors and High Net Worth Investors^a

Notification of the Securities and Exchange Commission No. KorChor. 5/2552

Re: Determination of Definitions in Notifications relating to Issuance and Offer for Sale of Debt Securities

Clause 3 In this Notification and the forms attached with the Notifications under Clause 2:

(2) definitions relating to type of investors:

(a) “institutional investors” means:

1. commercial banks;
2. finance companies;
3. securities companies for management of proprietary portfolios or private funds or investment projects established under laws governing finance business, securities business and credit foncier business;
4. credit foncier companies;
5. insurance companies;
6. government units and state enterprises under laws governing budgetary procedures or any other juristic persons established under specific laws;
7. Bank of Thailand;
8. international financial institutions;
9. Financial Institutions Development Fund;
10. Government Pension Fund;
11. provident funds;
12. mutual funds;
13. foreign investors with the same characteristics as investors under (1) to (12), mutatis mutandis;

(b) “high net worth investors” means:

1. individual persons having forty million baht or more of assets, excluding liabilities of such persons;
2. juristic persons having two hundred million baht or more of assets as recorded in the latest audited financial statements;

^a Emphases added by authors.

Source: Securities and Exchange Commission. Footnote 8. *Notification of the Securities and Exchange Commission No. KorChor. 5/2552 Re: Determination of Definitions in Notifications relating to Issuance and Offer for Sale of Debt Securities.* http://www.google.co.jp/url?sa=t&source=web&cd=1&sqj=2&ved=OCBkQFjAA&url=http%3A%2F%2Fcapital.sec.or.th%2Fwebapp%2Fnr%2Fdata%2F4604se.pdf&ei=Ob_-TFDxKfCvgPYmJyYAw&usq=AFQjCNEY6hzWoGDDgBFVMs-PNWUITp6pog

b. Public Offering and Disclosure Requirement

The second type is public offering (PO), which can be further subdivided into two additional categories. The bonds can be bought and sold by any investors. Since these bonds are offered to a variety of investors, they are more actively traded in the secondary market. This bond category can be registered to trade on the BEX. In reality, most of them are traded OTC.

A public offering of bonds carries for the bond issuer specific disclosure requirements. Disclosure means to reveal to the public relevant information on the issuer and the bond. The SET/BEX requires issuers to inform investors of material information, which may affect bond prices, bondholders' interests, or investment decisions. Examples of disclosure (filing) requirements are financial reports at the end of each accounting period, e.g., quarterly and annual financial statements, and annual reports. The promoters of publicly offered bonds are required to disclose (file) the information.

Box 1.3 Chapter XI of the Public Limited Companies Act^a

Public offering debentures shall be in accordance with the law on securities and stock exchange.

The PUBLIC LIMITED COMPANIES ACT, B.E. 2535 (1992)

CHAPTER XI
Debentures:

Section 145. The borrowing by the company by means of the issuance of debentures for offer for sale to the public shall be in accordance with the law on securities and stock exchange, and section 25 shall apply mutatis mutandis.
The resolution approving the issuance of debentures under paragraph one shall require the resolution of the meeting of shareholders passed by a vote of not less than three-fourths of the total number of votes of the shareholders attending the meeting and having the right to vote.

CHAPTER III

Offer of Shares for Sale to the Public

Section 24. The offer of shares for sale to the public or to any person shall be in accordance with the law on securities and stock exchange.

Section 25. The promoters or the company shall submit to the Registrar a copy of the documents relating to the offer of shares for sale to the public which shall be prepared and submitted to authorities under the law on securities and stock exchange, within fifteen days as from the date of submission to such authorities in accordance with the rules, procedures and conditions prescribed by the Registrar.

^a Emphases added by authors.

Source: <indicate source>. Government of Thailand. *Public Limited Companies Act*. <http://www.lawreform.go.th/lawreform/images/th/legis/en/act/1992/12878.pdf>

2. Secondary Market Trading

There are two secondary bond markets in Thailand: the OTC market under the ThaiBMA, formerly the Thai BDC, and BEX.

The ThaiBMA has three types of members:

- (i) Ordinary members – financial institutions with a debt-trading license (dealer);
- (ii) Extraordinary members – companies that have inter-dealer broker (IDB) licenses;
- (iii) Associate members – firms that facilitate trades of an ordinary member with a monthly average trading value in each of the past 12 months of less than THB100 million.

BEX is an electronic bond-trading platform overseen by the SET. Brokerage firm members trade corporate bonds issued by SET-listed companies on behalf of their clients. As stated above, bond trading in Thailand can take place either OTC or through the exchange. Since bonds are normally traded in a big lot and are traded less frequently compared to equities, most bonds circulated in the secondary market are traded OTC, which the buyer and seller negotiate either over the telephone or through an IDB.

Government bonds are the most actively traded securities, accounting for approximately 80–90% of total trade at any point in time.

a. Dealers

To trade debt instruments in Thailand, investors are required to trade only with dealers who are financial institutions licensed by the SEC to trade debt instruments. In 2010, 51 dealers had dealing licenses but no more than 15 of these were active dealers, most of whom were commercial banks.

b. Investors

Investors in the bond market are mainly institutions, including asset-management companies (AMCs) like mutual funds, provident funds and government pension funds, and banks and insurance companies. For instance, in November 2011, trading value (outright) between dealers and clients totaled THB933.37 billion. AMCs captured a share of 64.30% of market share, domestic companies (DCO) participated at 13.24%, foreign investors (FCO) captured 8.70%, the non-dealer license group (NDL) shared at 3.72%, insurance companies (INS) shared at 3.09%, and individual investors (IND) shared at 1.38%. Foreign investors have a sizable portion of the market.

Table 1.2 ThaiBMA Monthly Summary of Investments in the Bond Market (August 2011 and November 2011)

	Mar 2011	April 2011	May 2011	Jun 2011	Jul 2011	Aug 2011	Sep 2011	Oct 2011	Nov 2011
AMC	818.56	650.93	615.69	651.04	471.61	634.65	675.89	572.12	600.19
INS	32.48	18.64	21.48	18.71	15.52	18.91	29.35	22.41	28.86
NDL	40.58	53.88	70.09	58.97	31.49	40.89	50.96	34.81	34.70
DCO	174.07	128.01	97.60	121.68	75.34	117.82	135.82	88.41	123.59
FCO	170.31	216.95	128.76	102.67	216.10	189.62	168.57	79.31	81.19
IND	7.90	7.45	9.62	6.05	5.78	9.10	10.70	12.55	12.89
Others	67.61	66.85	58.37	68.17	40.84	66.32	58.25	33.05	51.95
Total	1,311.51	1,142.71	1,001.61	1,027.29	856.68	1,077.31	1,129.54	842.66	933.37

AMC = asset-management companies; DCO = domestic companies; FCO = foreign investors; IND = individual investors; INS = insurance companies; NDL = non-dealer license group
Source: Stock Exchange of Thailand. "Listing of Debt Instruments as Listed Securities," Regulations of the Stock Market of Thailand, http://www.set.or.th/en/products/bonds/bonds_p1.html; Extracts from "Background of ThaiBond Market," http://www.set.or.th/en/products/bonds/files/bond_knowledge_eng.pdf

c. Trading on the Over-the-Counter Market

Bond trading in Thailand mostly occurs on an OTC basis. Although the Electronic Trading Platform (ETP), BEX, exists at the SET, the volume through this channel has remained low (less than 5%). In the OTC market, transactions between dealers or inter-dealer trading can be done through either telephone or a broker called an IDB who acts as facilitator of the transaction. Currently, there are two IDBs in Thailand, namely ICAP and Wallstreet.

Trading in the secondary market can be grouped into two types: 1) dealer-to-dealer (inter-dealer) and 2) dealer-to-client. For dealer-to-client transactions, investors and dealers negotiate and trade their bonds via telephone.

All bond trades are required to be reported to ThaiBMA within 30 minutes after execution.

d. Market Monitoring and Surveillance in the Secondary Market

ThaiBMA monitors market movement and each trade transaction to ensure that there is no violation of regulation, wrongful conduct, or unfair trading. Besides daily and regular monitoring, ThaiBMA also reports to concerned authorities such as the SEC and the BOT.

3. Approval and Filing of Bonds

Table 1.3 Extract and Summary of Approval and Filing of Bonds in Thailand

Plain Debt	Thailand
1. Securities and Exchange Commission (SEC) Approval	
1.1. Public Offering (PO)	✓ :requires SEC approval
1.2. Non-Retail Investor (NRI)	✓ :approves in general ≤ 10 persons Institutional investor (II) and High net worth individuals (HNW)
1.3. Exempt	Treasury bill (T-bill), Government bond, Ministry of Finance (MOF) bond, Bank of Thailand (BOT) bond
2. Filing	
2.1. PO	✓ :requires filing with SEC
2.2. NRI	✓ :requires filing with SEC With Minimum disclosure
2.3. Exempt	< 10 persons T-bill, Government bond, MOF bond, BOT bond
Complex Debt	Thailand
1. SEC Approval	
1.1. PO	✓ :requires SEC approval
1.2. NRI	✓ :requires SEC approval < 10 persons II and HNW
1.3. Exempt	T-bill, Government bond, MOF bond, BOT bond
2. Filing	
2.1. PO	✓ :requires filing to SEC
2.2. NRI	✓ :requires filing to SEC Min. disclosure
2.3. Exempt	< 10 persons T-bill, Government bond, MOF bond, BOT bond

Note: ✓ = 'Yes,' 'exists,' or 'required'
Source: Securities and Exchange Commission Thailand.

4. Permission to Issue Baht-Denominated Bonds or Debentures by Foreign Entities

Box 1.4 Summary of Permission to Issue Baht-Denominated Bonds or Debentures by Foreign Entities in Thailand No. 42/2006 (3 May 2006)

As a strategy to develop [the] domestic bond market as a regional source of funding, the Minister of Finance had issued the Notifications to permit International Financial Institutions, Foreign Governments and Financial Institutions of Foreign Governments to issue Baht-denominated bonds or debentures in Thailand on April 21, 2004 and May 25, 2004, respectively.

To further promote the development of the bond market, on April 11, 2006, the Minister of Finance issued the “Notification: Permission to Issue Baht-denominated Bonds or Debentures in Thailand,” which stipulates rules for foreign entities to issue Baht-denominated bonds or debentures, and can be summarised as follows:

1. The eligible entities are international financial institutions established by conventions whether Thailand is a member or not, foreign governments or financial institutions of foreign government established by a specific law[,] and juristic persons established by laws of ASEAN+3 countries or any countries, which the Minister of Finance deems appropriate.
2. The tenure of the bond or debenture shall not be less than three (3) years.
3. The conditions under the new Notification shall apply to all bonds or debentures requested for approval from April 11, 2006. However, the bonds or debentures that have been requested, approved for issuance[,] and issued prior to this Notification will continue to be subject to the conditions stipulated under the Notification dated April 21, 2004 and May 25, 2004.

It is expected that by allowing foreign entities to issue Baht-denominated bonds or debentures in the domestic market will further promote the diversity of products and provide greater choice to the investors[,] as well as develop market infrastructure in support of the Asian Bond Market Initiative. This will enhance the Thai bond market as the regional source of funding in future.

As the key strategies to develop the bond market in Thailand as a regional source of funding, the Ministry of Finance has endeavoured to diversify bond products, expand the issuers and investors base in the Baht-denominated bonds or debentures in Thailand[,] and develop market infrastructure in support of the Asian Bond Market framework. In addition, the Securities and Exchange Commission has announced the disclosure requirements for the sale of Baht-denominated bonds or debentures issued by foreign entities in Thailand, which required the issuers to follow the conditions as stipulated and permitted by the Ministry of Finance.

Source: Ministry of Finance. http://www2.mof.go.th/press_releases_detail.php?id=3

5. Main Institutions in the Thailand Bond Market

a. The Stock Exchange of Thailand

The SET was established in April 1975 under the name “The Bangkok Stock Exchange,” as the primary stock market in Thailand. In 1999, the Market for Alternative Investment (MAI), a subsidiary of SET, was established as an alternative channel for fundraising of small and medium enterprises with high potential to grow, or newly established companies with high market value. SET has also launched the BEX in 2003 to support the secondary market for bond trading for individual investors. Information on bond knowledge and a related glossary may be found in the SET website.⁷

b. Bond Electronic Exchange

BEX, a department of SET, trades fixed-income securities of SET-listed corporations as an ETP. BEX started trading government bonds in June 2005, and represents and focuses on diversification, investor awareness, education, transparency, clearing and settlement, with an aim to ultimately increase market liquidity.

⁷ The Stock Exchange of Thailand (SET). <http://www.set.or.th/en>

c. Thailand Securities Depository

Clearing and settlement of securities traded on SET, MAI and BEX, including bonds trading on the OTC market, are done by TSD. Both government bonds and corporate debentures publicly sold are dematerialized and settled gross through TSD's PTI system, which is linked to the BOT's payment system namely "BAHTNET II".

The TSD is the official agency responsible for allocating International Securities Identification Number (ISIN) codes in Thailand using standard ISO 6166. TSD allocates ISIN codes for equities, corporate bonds, government bonds, warrants, and all other securities deposited with TSD.

d. Thai Bond Market Association⁸

In September 2005, the Thai Bond Dealing Centre became ThaiBMA. ThaiBMA is a self-regulating organization that functions as an information center, code and standard setter, forum for bond market development, and the frontline for market surveillance.

ThaiBMA is a securities business-related association under the *Securities and Exchange Commission Act B.E. 2535 (1992)*. Its main purposes are to be an SRO for a fair and efficient operation of the bond market and to be an information center for the Thai bond market. It also plays functional roles on market development, market convention and standards, and being a bond pricing agency for the industry. In addition, ThaiBMA provides a forum through which industry professionals can respond to current issues and play a role in shaping the future of the Thai bond market. As a bond pricing agency, ThaiBMA also provides model yield and pricing data for mark-to-market purpose of investors such as mutual funds, which are deemed very useful in the case of illiquid debts securities.

H. Wholesale and Retail Investors

Wholesale investors refer to institutional or juristic investors, while retail investors are individual investors. Thailand as a jurisdiction does not have an official concept of wholesale and retail. However, according to SEC regulations, so-called wholesale investors are categorized into 13 types of qualified institutional investors (QII), which comprise:

- (i) commercial banks;
- (ii) finance companies;
- (iii) securities companies for management of proprietary portfolios or private funds, or investment projects established under laws governing finance business, securities business, and credit foncier business;
- (iv) credit foncier companies;
- (v) insurance companies;
- (vi) government units and state enterprises under laws governing budgetary procedures, or any other juristic persons established under specific laws;
- (vii) Bank of Thailand;
- (viii) international financial institutions;

⁸ Footnote 3. <http://www.thaibma.or.th/aboutus/aboutus.html>

- (ix) Financial Institutions Development Fund;
- (x) government pension fund;
- (xi) provident funds;
- (xii) mutual funds; and
- (xiii) foreign investors with the same characteristics as investors under (1) to (12), mutatis mutandis.

The concept of QII does not only apply to securities available for sale in the exchange market but applies to debentures issued through private placement.

I. Definition of Professionals and Professional Investors

There is no defined concept of professionals; however, it can be assumed that wholesale institutional investors represent the professionals. The concepts of the institutional investors and high net worth investors exist in Thailand. These concepts are related to the rule on exemption to full disclosure-based regulations. See below for the definitions of institutional investors and high net worth investors.

J. Definition of Qualified Institutional Investors

Clause 3 of the “Notification of the Securities and Exchange Commission No.KorChor.5/2552

Re: Determination of Definitions in Notifications relating to Issuance and Offer for Sale of Debt Securities”⁹ and the forms attached with the Notifications under Clause 2 on the definitions relating to type of investors provide a clear definition of institutional investors and high net worth individuals as follows:

- (a) “Institutional investors” refer to:
 - (1) commercial banks;
 - (2) finance companies;
 - (3) securities companies for management of proprietary portfolios or private funds or investment projects established under laws governing finance business, securities business and credit foncier business;
 - (4) credit foncier companies;
 - (5) insurance companies;
 - (6) government units and state enterprises under laws governing budgetary procedures or any other juristic persons established under specific laws;
 - (7) Bank of Thailand;
 - (8) international financial institutions;
 - (9) Financial Institutions Development Fund;
 - (10) government pension fund;
 - (11) provident funds;
 - (12) mutual funds; and
 - (13) foreign investors with the same characteristics as investors under (1) to (12), mutatis mutandis.

⁹ Footnote 10.

- (b) “High net worth investors” are individuals having assets worth THB40 million or more, excluding liabilities of such persons. It also includes juristic persons having THB200 million or more assets as recorded in their latest audited financial statements.

K. Credit Rating System

According to SEC regulations, newly issued debentures through public (PO) issues must have a credit rating from an authorized credit rating agency. Most private placement (PP) issues are also required to have credit ratings but with more relaxed regulation (see Part II.C.2). To elaborate, PO issues need to have issue ratings, PP issues can choose to have either issue or issuer ratings. PP with limited distribution (i.e., not exceeding 10 investors) is exempted from ratings.

Presently, there are two credit rating agencies (CRAs) authorized by the SEC in Thailand, namely, TRIS Rating and Fitch Ratings (Thailand). A list of credit rating agencies that have been given an approval by the SEC can be found in the SEC website.¹⁰

Currently, there are three major government and public agencies that play a pivotal role in formulating policies on CRAs and in regulating the Thai bond markets: the MOF, BOT, and the SEC.

Table 1.4 Summary of Credit Rating System

	YES	NO
Are credit rating agencies (CRAs) regulated?	X	
Is it mandatory to have credit rating for issuance of corporate bonds?	X	
Are ratings provided by international agencies permitted?	X	
Is it possible to get more than one rating for a corporate bond issue?	X	
If it is possible to get more than one rating for a corporate bond issue, is it mandatory to disclose all ratings for that issue?	X	
Is it mandatory for CRAs to update all corporate bond issues? If yes then what is the time interval after which the ratings need to be updated?	X (typically annually)	
Are unsolicited ratings permitted?	X	
Source: Securities and Exchange Commission Thailand.		

Normally, the rating agencies update company ratings once a year. If there is any circumstance which may impact company’s performance or its financial status, the CRA has the responsibility to monitor and update the rating of such company.

¹⁰ Footnote8.http://www.sec.or.th/securities_issuance/Content_0000000226.jsp?categoryID=CAT0000200&lang=en

L. Related Systems for Investor Protection

1. Retail Investors

There are no specific rules governing retail investors in the Thai bond market. The ThaiBMA provides a special website for retail investors, thaibond.com. Most financial institutions in Thailand provide services for retail investors interested in buying and selling bonds.

2. Foreign investors

There are no restrictions on foreign investors investing in Thai securities. Direct and portfolio investments are freely permitted. Capital can be freely transferred into the country and deposited in a foreign currency account with an authorized bank within 7 days.

Investment funds, dividends, profits, and interest payments after settlement of taxes can be repatriated freely. Securities, PNs, and BEs may be sent abroad without restriction. Section IV of the Exchange Control Regulations in Thailand by the BOT, a guide for the general public, discusses the exchange regulations for foreign investments. It states that

Transfers in foreign currency for direct and portfolio investments in Thailand are freely permitted. Proceeds must be surrendered to an authorized bank or deposited in a foreign currency account with an authorized bank in Thailand within 360 days.

Repatriation of investment funds and repayment of overseas loans can be remitted freely upon submission of supporting documents to an authorized bank. For repatriation of investment funds, evidence of sale or transfer of such investment shall be submitted. For loan repayment, evidence of inward remittance of such loan and loan agreement shall be submitted.¹¹

3. Bondholder Rights and Bondholder Representative

The *Civil and Commercial Code and the Bankruptcy Act* cover basic bondholder rights.¹² The *Civil and Commercial Code* covers the principles and rules for civil law for business and individuals. Obligations, contracts, mortgage, and other forms of loan security also fall under the *Civil and Commercial Code*, as well as liquidation procedures for insolvent debtors.

Under the *Bankruptcy Act*, creditors, including the bondholders, can file a petition with the Bankruptcy Court for a rehabilitation or bankruptcy proceeding against a debtor's business. Indenture agreements in bond issues can also specify a bondholder representative. The bondholder representative oversees bondholder rights, including the filing of claims and demand of payments from the issuer or guarantors. Bondholders can sue and claim damages from the bondholder representative in case it acts in bad faith or causes damages to bondholders. Foreign bondholders have rights similar to Thai bondholders.

¹¹ Footnote 4. <http://www.bot.or.th/English/ForeignExchangeRegulations/FXRegulation/Pages/ExchangeControllLaw.aspx>

¹² Government of Thailand. *Civil and Commercial Code*. <http://www.samuihorsale.com/Law-Texts/thailand-civil-code-part-1.html>; http://www.insolvencyasia.com/supplement_report/thailand.html; and Leeds, Jonathan. n.d. "The Act Establishing Thailand's New Bankruptcy Court." Thailand Law Source. <http://asialaw.tripod.com/articles/bankcourt.htm>

Bond documents (e.g., prospectus, term sheets, or indenture agreements) may also contain covenants and relevant default clauses specific to the bond issue to provide additional protection for bondholders. ThaiBMA provides copies of corporate bond prospectuses.

The “Asia-Pacific Restructuring and Insolvency Guide 2006” provides information on creditor rights in Asia-Pacific countries.¹³

4. Prevention of Fraud

The Enforcement Department of the SEC investigates and gathers evidence on possible offenses under the *Securities and Exchange Act*, the *Provident Fund Act*, and the *Royal Enactment on Special Purpose Juristic Persons for Securitization*. Typical violations under SEC purview include insider trading, share-price manipulation, false or misleading information regarding securities, operating securities businesses without proper licenses, mismanagement, and fraud.

5. Ethics

The SET serves as a center for trading listed securities. It is an SRO that governs member companies’ conduct in dealing securities. SET is also responsible for marketplace surveillance, and supervising and enforcing disclosure standards for listed companies. It provides essential systems for securities trading, such as a clearing house, securities depository center, and securities registrar.

The Thailand Futures Exchange (TFEX), a subsidiary of SET, is a derivatives exchange that offers products for effective hedging. It is governed by the *Derivatives Act of 2003* under the supervision of SEC. The TFEX trading infrastructure is designed to ensure a fair, orderly, and transparent market by offering market participants a high-quality, cost-efficient, and comprehensive range of services including an order-entry facility, a matching system, and market dissemination through an ETP.

SET also operates BEX. Relevant trading rules and guidelines on membership, registration, and other requirements are available at the SET website.¹⁴

ThaiBMA facilitates the secondary bond market, registers dealers, and monitors all market activity. It is self-regulatory and operates standards and conventions for bond trading. ThaiBMA website provides guidelines on membership, registration and trading of debt instruments, registration of traders, ethics and good practices of dealers, and reporting requirements.¹⁵

6. The *Securities and Exchange Act B.E. 2551 (2008)*

The *SEC Act B.E. 2551 (2008)* came into force on 5 March 2008. The *SEC Act* provides strong protection for investor interests and enhances corporate governance of listed companies. It is a robust foundation for quality products and confidence in the Thai capital market. The *SEC Act* comprises three major areas—(1) Regulatory Bodies,

¹³ Asian Development Bank. 2006. *The Asia-Pacific Restructuring and Insolvency Guide 2006*. Malaysia: Shearn Delamore & Co. and PricewaterhouseCoopers. <http://www.adb.org/Documents/Guidelines/restructuring-insolvency/chap4-15.pdf>

¹⁴ Footnote 14. http://www.set.or.th/en/regulations/rules/enforce_p1.html

¹⁵ Footnote 3. <http://www.thaibma.or.th/main.html>; <http://www.thaibma.or.th/sro/section6.pdf>; and <http://www.thaibma.or.th/sro/section7.pdf>

(2) Corporate Good Governance, and (3) Investor Protections— to raise the standard of the Thai Capital Market to the international level.

The portion on “Investor Protections” includes:

- (i) Proposed agenda items for shareholders’ meetings.
- (ii) Sueing for damages from disclosure of falsified information.
- (iii) Claim to disgorge ill-gotten benefits obtained by company directors or management in bad faith.
- (iv) Receiving reasonable litigation expenses from the company as ordered by the court.
- (v) Directors and management of companies shall be provided with a clearer scope of duties and liabilities.

7. The Trust for Transactions in Capital Market Act B.E. 2551 (2008)

The *Trust for Transactions in Capital Market Act* (Trust Act) came into effect on 16 April 2008. The objectives of the new Trust Act are to strengthen and to introduce new investment alternatives to the Thai capital market. The Trust Act is summarized as follows:

a. Characteristics of a Trust

A trust is a legal binding of three parties as follows:

(i) Settlor

A settlor under the Trust Act is limited only to a juristic person who is an issuer of securities under *SEC Act B.E. 2551 (2008)* or an originator in a securitization transaction, or as specified by the SEC.

(ii) Trustee

Licenses authorized by the SEC are required. Trustees can be commercial banks or financial institutions, banks established under the specific laws, or other juristic persons as specified by the SEC. A list of trustees who have been given an approval by the SEC can be found in the SEC website.¹⁶

(iii) Beneficiary

There is no restriction imposed on the type of person who can be classified as a beneficiary. Also, the settlor and trustee can be a beneficiary. The Trust Act provides that the interest of such settlor/beneficiary and trustee/beneficiary in the trust fund must not exceed the limit specified by the SEC. Otherwise, the excess portion will be shared among the other beneficiaries to that trust.

b. Types of Trusts

There are two types of trusts under the new Trust Act.

(i) Passive Trust

- (a) Employee Stock Option Plan
- (b) Derivative Warrant

¹⁶ Footnote 8. http://www.sec.or.th/securities_issuance/Content_0000000233.jsp?categoryID=CAT0000201&lang=en

- (c) Bonds Issuance
- (d) Securitization

(ii) Active Trust

- (a) Institutional Investor and High Net Worth Trust Fund
- (b) Real Estate Investment Trust
- (c) Special Purpose Trust
- (d) Employee Joint Investment Program
- (e) Islamic Bond (*Sukuk*)

c. Creation of Trusts

Under the Trust Act, a trust is required to be created through a contract between a settlor and a trustee where the settlor expresses an intention to create a trust, as well as transfers property to the trustee, and submits a letter stating its intention to create a trust to the SEC. If the settlor and the trustee are the same person, a transfer of assets is not required.

The Trust Act requires that a trust may be created only for transactions which will benefit the capital markets, for instance, in the issuance of securities or securitization transactions. Therefore, trusts used exclusively in banking transactions and not related to capital market transactions cannot be created.

d. Fiduciary Relationship

The fiduciary relationship focuses on three key rules.

- i. **Bankruptcy Remoteness.** A trust property legally owned by a trustee shall not be enforced for payment to creditors of the trustee even though the trustee becomes bankrupt.
- ii. **Fiduciary Duties.** A trustee shall manage trust with skills, loyalty and reasonable care for the best interest of the beneficiary, and shall not put itself in a position where there may be conflict of interests unless it is remuneration or a fair transaction being sufficiently disclosed to the beneficiary in advance and no objection from the beneficiary.
- iii. **Beneficiary Protection.** Tracing and recovery are tools for protecting the beneficiary's interest. In case of tracing, a beneficiary has the power to trace trust property from a third party who receives such property with bad faith, or knowing or having reasonable grounds to know that it is a breach of trust or without consideration. For recovery, the beneficiary has the right to claim compensation for benefit of the trust from a trustee who fails to manage the trust property in accordance with the trust contract or the Trust Act itself.

e. Eligible Persons

Persons who are eligible to apply for an approval to undertake trust business are:

- (i) A commercial bank under the *Financial Institutions Business Act*;
- (ii) A financial institution established under specific laws;
- (iii) A security company with eligible licenses as broker, dealer, underwriter, mutual fund, and private license.

f. Bondholder Representative or Trustee

A bondholder representative (BR) or debenture holder representative cannot play a trustee's role in Thailand. There are separate rules and regulations that govern BRs and trustees. The BR's role is to protect the bondholder. Its role is defined in the *Securities and Exchange Act*.

On the other hand, the role of a trustee is stated in the Trust Act. The Trust Act exists but does not have a significant bearing on bond issuance. The objective of the Trust Act is to strengthen and introduce new investment alternatives to the Thai capital market.

Public bond issuance requires a BR and must register with the SEC. The BR sets up the contract and the terms and conditions for the bond issue, following SEC guidelines. A BR has fiduciary duties, as well as any duty and liability set out in the terms and conditions. Both the appointment of a BR and the actual terms and conditions need to be registered with the SEC.

g. Debenture Representatives

Debenture representatives are responsible for implementing the debenture holders' resolutions. Under Thai law, debenture representative responsibilities are very similar to the activities of a trustee. Responsibilities and obligations of a debenture representative have been stipulated in the law and are more specific in the terms and conditions of the debenture.

8. The Deposit Insurance Act B.E. 2551 (2008)

The Deposit Insurance Agency (DIA) was launched on 11 August 2008 under the *Deposit Insurance Act*. The DIA was established to protect depositors within a certain coverage amount against the loss of their deposits placed in a financial institution. The source of funds for compensation mainly comes from premiums collected from financial institutions, which are members of the deposit insurance system. Non-resident accounts, however, are not protected under this act.

The key features of the *Deposit Insurance Act* are:

- (a) Membership to the DIA is compulsory for commercial banks, foreign bank branches, finance companies, and credit finance companies. Members will pay premiums to the DIA at the rate of 0.4% annually on deposits. This premium rate is expected to vary in the future.
- (b) The maximum coverage is THB1 million per depositor per institution. The amount of deposit that exceeds this coverage is to be recovered from the assets of the failed institution through the process of liquidation. The authority will gradually reduce coverage from full guarantee to the target amount at THB1 million within 4 years. In the first year of the establishment of the DIA in 2008, full coverage was maintained. The coverage will be reduced annually to THB100 million, THB50 million, THB10 million, and finally THB1 million on the fifth year of the DIA's establishment in 2012.
- (c) The DIA will act as a liquidator of a failed financial institution, reimburse the compensation made, and also pay other creditors according to their shares.

M. Governing Laws on Bond Issuance

Governing laws on bond issuance, self-governing rules, and related legal and regulatory issues behind the market include:

- (i) SEC Act B.E.2535 and its regulations¹⁷
- (ii) BOT Act B.E.2485¹⁸
- (iii) Regulations of the MOF–PDMO

As stated above, the SEC Act and SEC notifications govern the issuance of corporate bonds. Government bonds and state-enterprise bonds are issued under the *Public Debt Management Act*. BOT bonds are issued under BOT Regulation.

N. Transfers of Interests in Bonds

1. General Rule

The transfer of debentures will be valid upon delivery of such debentures with the endorsement of transfer by persons having their names as owners or by the last transferee. The transfer will legally bind a third party once the transfer has been registered with the debenture issuer in the debenture register book. For government securities, transfer is done on a delivery-versus-payment (DVP) basis.

2. Actual Registration and Transfer Process

The TSD is the depository for equities, corporate bonds, and government bonds. Securities held with the TSD are registered in the name of “Thailand Securities Depository Company Limited for Depositors.” Securities transferred within the TSD do not require re-registration.

Scripless securities from a settled purchase can be redelivered on settlement date. Physical certificates can be converted to scripless form at the depository within the same day.

Re-registration of physical certificates following a purchase takes approximately 30 to 45 business days, during which time the security cannot be sold. Although corporate bond dealers instruct the TSD to transfer bonds to the counterparty upon receipt of cash payment by check, registration of corporate bonds is done separately with the registrar appointed by the issuing company.

Removal of the securities from the TSD in physical form can take 30 to 45 business days, and the TSD assesses a service charge for the withdrawal of physical securities. The TSD is the registrar for most listed corporate bonds. Unlisted securities and shares can be registered in the investor’s own name, or in the name of a global custodian, in care of the sub-custodian. Local nominee registration is prohibited. The sub-custodian sends non-TSD eligible securities for registration upon receipt, unless there are specific instructions to hold the securities in street name. Investors can

¹⁷ Footnote 8. http://www.sec.or.th/laws_notification/Content_0000000189.jsp?categoryID=CAT0000015&lang=en

¹⁸ Footnote 4. http://www.bot.or.th/English/FinancialInstitutionsDevelopmentFund/Law_Notification/DocLib_Acts/Act_BOTb.e.2485.pdf

hold securities and shares in street name, but they will not receive entitlements from corporate events.

Physical securities and shares from a settled purchase can be delivered onwards once all required documents are in place. The BOT acts as the registrar for government securities (T-bills, SOE-guaranteed bonds, and financial institution development bonds), which are registered in beneficial owner name, or in the global custodian's name, under the Bond Registry System.

Under the Bond Registry System, the buyer and seller must endorse the back of the certificates and submit original written instructions to the BOT. The title to the securities passes on T+2 after the proceeds are credited to the seller's cash account.

3. Custodian Bank Point of View

Custodian banks recognize only the registered owner (their client), and they may not know or recognize the end-beneficiary owner. For the transfer of securities, custodian banks only act upon instructions of their clients.

“Book Closed Date” or Record Date, they will submit their client name or registered owner who has holding over those securities as of ‘End of Day of Record Date’ to the Securities Registrar to ensure that their clients receive the (mandatory) Corporate Action entitlement, i.e. coupon payment. For a Voluntary Corporate Action, they shall wait for their client's instructions if the client wishes to participate in a particular corporate action event.

O. Definition of Securities

1. Definition in the *Securities and Exchange Act*

Sec. 4 of the *Securities and Exchange Act B.E. 2535* stipulates the definition of securities as follows:¹⁹

In this Act “securities” means,

- (1) Treasury bills;
- (2) Bonds;
- (3) Bills;
- (4) Shares;
- (5) Debentures;
- (6) Investment units which are instruments of evidence representing the rights to the property of a mutual fund;
- (7) Certificates representing the rights to purchase shares;
- (8) Certificates representing the rights to purchase debentures;
- (9) Certificates representing the rights to purchase investment units;
- (10) Any other instruments as specified by the SEC.

“Bill” means any bill issued for raising funds from the public as specified in the notification of the SEC.

¹⁹ Footnote 8. http://www.sec.or.th/laws_notification/Content_0000000189.jsp?categoryID=CAT0000015&lang=en

“Debenture” means any debt instrument or whatever name excluding bills, divided into units, each with equal value and a predetermined rate of return, issued by any company to a lender of purchaser, representing the right of the holder of such instrument to receive money or other benefit.

2. Debentures on the *Public Limited Companies Act, B.E. 2535 (1992)*

Debentures are stipulated in Chapter XI of the *Public Limited Companies Act* and states that

CHAPTER XI Debentures:

Section 145. The borrowing by the company by means of the issuance of debentures for offer for sale to the public shall be in accordance with the law on securities and stock exchange, and Section 25 shall apply mutatis mutandis.

The resolution approving the issuance of debentures under Paragraph 1 shall require the resolution of the meeting of shareholders passed by a vote of not less than three-fourths of the total number of votes of the shareholders attending the meeting and having the right to vote.

P. Self-Governing Rules behind the Market

1. The Thai Bond Market Association

The ThaiBMA is an SRO licensed to run an efficient market and act as an information center for Thailand’s secondary bond market. It is responsible for developing the market, establishing market conventions and standards, and acting as a bond pricing agency. It also provides a forum for market professionals to move toward a more mature and sophisticated Thai bond market.

a. ThaiBMA Members

Membership of ThaiBMA can be classified into three types, each of which is subject to different membership fees and requirements.

- (i) An Ordinary Member is a financial institution that has a debt trading license (dealer).
- (ii) An Extraordinary Member is a company that has an IDB license.
- (iii) An Associate Member is provided for a dealer that has a monthly average trading value in the past year of less than THB100 million per month.

In June 2007, membership of ThaiBMA consisted of 52 commercial banks and securities companies.

b. Roles and Functions of the Thai Bond Market Association as a Self-Regulatory Organization

ThaiBMA oversees and monitors the conduct of its members to ensure fairness and efficiency in debt securities trading. It is committed to retaining the confidence of its membership, regulators and investors. Parts of its functions as an SRO include the following:

- (i) Perform market monitoring and surveillance to ensure that all trading activities comply with relevant laws and regulations, and act as the front line to detect any unfair trading practices.
- (ii) Established the Ethics and Code of Conduct for members and traders.
- (iii) Issue rules and guidelines regarding debt securities trading and good market practice.
- (iv) Responsible for bond trader examination and registration, and provide them with ongoing education to enhance their professionalism.
- (v) Determine enforcement procedure to penalize those who do not comply with the regulations.

There is a Memorandum of Understanding between the SEC and ThaiBMA on bond market supervisory cooperation. To enhance bond market best practices and ensure that these are applied, registered traders should have adequate knowledge in relevant rules, regulations and ethics, as well as knowledge in the bond market. Effective 16 November 2005, SEC regulations require all securities companies to appoint a trader registered with the ThaiBMA in bond trading.

2. Exchange in Thailand

The SET is a juristic entity set up under the *Securities Exchange of Thailand Act, B.E. 2517 (1974)*. In addition to its function as the exchange operator, it fulfills the role of an SRO by setting and governing the listing, trading, surveillance and disclosure obligations, and practices of its participants.

Q. Bankruptcy Procedures

According to the *Bankruptcy Act B.E. 2483 (1940)*, corporate bondholders shall be treated as ordinary creditors. In addition, under the *Securities and Exchange Act B.E. 2535 (1992)* and the *Trust for Transactions in Capital Market Act B.E. 2550 (2007)*, if the issuer of corporate bonds sets up a reserve account or sinking fund in the form of a trust, bondholders shall have bankruptcy remoteness and have, ultimately, rights to that trust property. When the company goes bankrupt, corporate bondholders shall have the right to the property of the company and to receive performance of an obligation due to them according to the following ranks.

- (1) Bondholders for which the issuer has set up a reserve account or sinking fund in the form of a trust
- (2) Secured creditors
- (3) Unsecured creditors

Further details on the restructuring and insolvency frameworks of Asia-Pacific countries, including that of Thailand can be found in “The Asia-Pacific Restructuring and Insolvency Guide 2006.”²⁰

²⁰ Footnote 20.

R. Bondholder Representative

In case of publicly offered bonds, a bondholder representative (BR) is responsible for implementing the bondholder resolutions. Public bond issuance requires a BR who must register with the SEC. Under Thai law, BR responsibilities are very similar to the activities of a trustee in other jurisdictions. Responsibilities and obligations of a BR are stipulated in the law and are more specific in the terms and conditions of the debenture.

As described earlier, indenture agreements in bond issues can also specify a BR. The BR oversees bondholder rights, including the filing of claims and demand of payments from the issuer or guarantors. Bondholders can sue and claim for damages from the BR in case the BR acts in bad faith or causes damages to bondholders.

The BR sets up the contract and the terms and conditions for the bond issue, following SEC guidelines. The BR has a fiduciary duty, as well as any duty and liability set out in the terms and conditions. Both the appointment of a BR and the actual terms and conditions need to be registered with the SEC.

S. Event of Default

Generally, an event of default is stipulated in the terms and conditions of the debenture. Under Thai law, the terms and conditions are deemed to be an agreement between the debenture issuer and the debenture holder. The following are examples of events of default that are normally stipulated in the terms and conditions of a debenture:

1. Non-payment – If the issuer makes a default in the payment of any principal, premium or interest due in respect of the bonds.
2. Breach of Other Obligation – If the issuer does not perform or comply with one or more of its other obligations under the bonds, the Trust Deed, or terms and conditions.
3. Insolvency – If the issuer, or any of its group entities, becomes insolvent or bankrupt, or is unable to pay its debts, stops, suspends or threatens to stop or suspend payment of all, or a material part, of its debts by court order.
4. Enforcement Proceeding – If a distress, attachment, execution, seizure before judgment or other legal process is levied on, enforced or sued against any material part of the property, assets or turnover of the issuer or any of its group entities, and is not discharged or stayed within 60 days.
5. Winding Up – If an order is made or an effective resolution passed for the winding up, dissolution or administration of the issuer or any of its group entities.
6. Security Enforced – If an encumbrancer takes possession, or an administrative or other receiver, or an administrator or other similar officer is appointed of the

whole or any substantial part of the property, assets or turnover of the issuer or any of its group entities, and is not discharged within 60 days.

The debenture holder and/or debenture holder representative (trustee) will normally recognize and declare default. The declaration of an event of default is made in accordance with the terms and conditions of the debentures. Thai law is silent on whether the default happens during the day or at the end of the day. However, in practice, the default immediately occurs when the debenture holder or debenture holder representative (trustee) declares an event of default. The precedent of a default of debentures normally occurs on the grounds that the debenture issuer fails to pay interest and to repay the principal to the debenture holder when due.

T. Major Market Participants

Thailand's fixed-income market participants include issuers from the government and corporate sectors. Major bond investors include pension funds or provident funds, AMCs, mutual funds, commercial banks, government savings banks, insurance companies, savings funds, and corporate and retail investors. A number of authorized securities companies and a few market associations also participate in the market. The Thai market is covered by a number of CRAs, whose rating efforts cover financial institutions, private companies, and state enterprises.

U. Degree of Opening of Domestic Bond Markets to Foreign Investors and/or Issuers

In 2004, the MOF announced permission for foreign institutions to issue baht-denominated bonds for trading in Thailand, with restrictions on certain institutions as below:

1. International financial institutions incorporated under treaties, whether or not Thailand is a member of those treaties.
2. Foreign governments or foreign government institutions incorporated under specific laws.
3. Juristic persons incorporated under foreign laws who are not entitled to the common permission but must apply for it on a case-by-case basis, and are prohibited from remitting Thai baht out of the country.

Overseas remittance is possible only after foreign exchange

The issuance of bonds in this connection must come under commitments with and permission of the MOF. Issuers must complete the offering of bond within 9 months after permission has been granted by the MOF. Limited companies and public companies incorporated under foreign laws are allowed to issue bonds under the assumption of permission from the SEC.

V. ASEAN Bond Market Development Scorecard (Revised): Thailand

Table 1.5 summarizes Thailand's Bond Market Development Scorecard. The Association of Southeast Asian Nations (ASEAN) Bond Market Development Scorecard: Thailand can be found in Appendix 2. The ASEAN Bond Development Scorecard can be found in Appendix 3.

Table 1.5 Summary of ASEAN Bond Market Development Scorecard for Thailand

	ASEAN Bond Market Development Scorecard	Regulatory / Market Development	Resident / Non-Resident / Both	Thailand	
				✓ = Yes X = No	
A	ISSUER				
1	Market Access				
a)	Acceptance of MTN programmes	Reg	Both	✓	
ai)	International MTN programmes	Reg	Both	X	MOF is considering this issue. Applying the international MTN program may work against the MOF's objectives of balancing the financial system, given the risk that the MTN program may hinder development of less-developed domestic bond markets, levels of development across the region remain unequal. Furthermore, in instances where domestic liquidity is tight, it may raise the cost of raising funds in the domestic market.
aii)	Local MTN programmes	Reg	Both	✓	Shelf filing
b)	Removal of discriminatory restrictions on issuance by non-residents	Reg	Non-resident	✓	Thailand has opened up for NR issuers; however, approval remains subject to MOF and BOT's consideration (use of proceeds, credit rating, and overall financial system liquidity). Thai SEC has adopted ASEAN standard, which means a Singaporean firm may submit the filing document used in Singapore to the Thai SEC, for bond issuance in Thailand.
2	Transparency				
a)	Disclosure standards - Adoption of ASEAN and Plus Standards	Reg	Both	✓	
ai)	Accounting standards - Adoption of IFRS for cross-border offerings	Reg	Both	✓	ASEAN Standard (form 69-FD, or 69-base)
aii)	Auditing standards - Adoption of ISA for cross-border offerings	Reg	Both	✓	ASEAN Standard (form 69-FD, or 69-base)
B	INVESTOR				
3	Market Access				
a)	Non-resident market access	Reg	Non-resident	✓	
ai)	Elimination of investor registration requirements	Reg	Non-resident	✓	
aii)	Removal of discriminatory restrictions on investment by non-resident investors	Reg	Non-resident	✓	
aiii)	Removal of discriminatory restrictions on non-resident institutional investors' portfolio composition	Reg	Non-resident	✓	
aiv)	Removal of restrictions on non-resident LCY borrowing (i.e., intraday credit/ overnight credit, etc.)	Reg	Non-resident	X	NRs can obtain baht through a swap transaction.
b)	Removal of investment restrictions on resident investors	Reg	Resident	✓	

continued on next page

Table 1.5 continuation

	ASEAN Bond Market Development Scorecard	Regulatory / Market Development	Resident / Non-Resident / Both	Thailand	
				✓ = Yes X = No	
c)	Existence of clear legislation on bondholders' rights	Reg	Both	✓	Details about bondholders' rights are stated in the prospectus. It is easy to access both prospectus and covenants governing bondholders' rights through the SEC and issuers website. In addition, there is a regulation on bondholders' representative to ensure that bondholders' rights are clearly defined and therefore protected.
4	Transparency				
a)	Disclosure of government bond issuance calendar	Reg	Both	✓	A yearly plan is announced following a dialogue between BOT, MOF, Thai BMA, PDs, and investors. Quarterly schedule is announced two Fridays before the beginning of each quarter.
b)	Regular data on holdings by investor class, i.e., banks, insurance/pension funds, foreigners, retail	Reg	Both	✓	Monthly basis (only on government bonds) Quarterly basis (on corporate bonds) ^a
c)	Availability of benchmarks at regular intervals	Mkt Dev	Both	✓	Regular benchmark bond tenor (5/10/15/20/30 years) is offered every other month
d)	Inclusion in an internationally accepted bond index	Mkt Dev	Both	✓	iBoxx ABF Thailand Index (International Index Company Limited: IIC)
5	Funding / Hedging Instruments				
a)	Availability of active repo / securities borrowing and lending market	Mkt Dev	Both	✓	
ai)	Term ≤ 2 weeks	Mkt Dev	Both	✓	
aii)	Term ≥ 2 weeks	Mkt Dev	Both	✓	
aiii)	PD to PD activity (Onshore interbank)	Mkt Dev	Both	✓	
aiv)	PD to non-PD allowed	Mkt Dev	Both	✓	
av)	Bank to non-bank (i.e. end user customer) allowed	Mkt Dev	Both	✓	
avi)	Use of Global Master Repo Agreement	Mkt Dev	Both	✓	
b)	Availability of active interest rate swap market	Mkt Dev	Both	✓	(up to 5 years maturity)
bi)	Use of ISDA Master Agreement	Mkt Dev	Both	✓	
c)	Availability of active futures market	Mkt Dev	Both	✓	Trading Interest Rate Future by end of 2010
ci)	Government bond futures	Mkt Dev	Both	✓	5-year Government Bond Futures (18 Oct 2010)
cii)	Short-term Interest rate futures	Mkt Dev	Both	✓	THB3 million BIBOR Futures and THB6 million FIX Futures (29 Nov 2010)
d)	Suitably wide range of securities eligible for central bank liquidity	Reg	Resident	✓	
di)	Inclusion of government-guaranteed LCY bonds under permitted instruments for the central bank repo facility	Reg	Resident	✓	
dii)	Inclusion of government-guaranteed LCY bonds under local statutory reserve requirements	Reg	Resident	✓	
diii)	Incorporation into reserve ratios/creation of separate regulatory reserve ratio(s) for government-guaranteed LCY bonds	Reg	Resident	✓	
div)	Incorporation into reserve ratios/creation of separate regulatory reserve ratio(s) for supranational bonds	Reg	Resident	✓	Accepted only in emergency case

continued on next page

Table 1.4 continuation

	ASEAN Bond Market Development Scorecard	Regulatory / Market Development	Resident / Non-Resident / Both	Thailand	
				✓ = Yes X = No	
6	Tax Treatment				
a)	Exemption from withholding tax	Reg	Both	X	
ai)	Exemption from withholding tax on government bonds - resident	Reg	Resident	X	
aii)	Exemption from withholding tax on government bonds - non-resident	Reg	Non-resident	X	
aiii)	Exemption from withholding tax on corporate bonds - resident	Reg	Resident	X	
aiv)	Exemption from withholding tax on corporate bonds - non-resident	Reg	Non-resident	X	
7	Settlement and Custody				
a)	Use of SWIFT as standardized message format	Mkt Dev	Both	✓	
b)	Use of ISIN securities numbering scheme	Mkt Dev	Both	✓	
c)	DvP - Use of electronic trade-matching	Mkt Dev	Both	✓	
d)	DvP - Use of settlement pre-matching	Mkt Dev	Both	✓	
e)	DvP - Effective depository links for cross-border settlement and custody	Mkt Dev	Both	X	
a Thai BMA. Footnote 3. http://www.thaibma.or.th/CorpBondHolder_report/CorpBondHolderPage.aspx Notes: ✓ = Yes X = No ASEAN = Association of Southeast Asian Nations; BIBOR = Bangkok Interbank Offered Rate; BOT = Bank of Thailand; DvP = delivery versus payment; IFRS = International Financial Reporting Standards; ISDA = International Swaps and Derivatives Association; ISIN = International Securities Identification Number; LCY = local currency; MOF = Ministry of Finance; MTN = medium-term notes; NR = non-resident; PD = primary dealer; SEC = Securities and Exchange Commission of Thailand; SWIFT = Society for Worldwide Interbank Financial Telecommunication; ThaiBMA = Thai Bond Market Association Source: Securities and Exchange Commission Thailand.					

II. Primary and Secondary Market Regulatory Frameworks

A. Rules and Regulations in the Thai Market Regulatory Structure

Thailand's capital market is governed by the rules and regulations issued and enforced by the Bank of Thailand (BOT), Ministry of Finance (MOF), Securities and Exchange Commission (SEC), the Thai Bond Market Association (ThaiBMA), and the Stock Exchange of Thailand (SET).

Market regulators in the Thai capital market include the MOF, BOT, and the SEC.

1. Ministry of Finance²¹

The MOF is the preeminent regulator and oversees the entire financial and capital market of Thailand. The activities of the BOT and the SEC are overseen by MOF.

The roles and responsibilities of the MOF are as follows:

- (i) The MOF is the top administrator who sets the overall fiscal and monetary policy directions of the government.
- (ii) It oversees matters concerning fiscal policy, customs, excise, revenue, public debt, and policy on state enterprises.
- (iii) It is also vested with the power to provide loan guarantees for government agencies, financial institutions, and state enterprises.

2. Bank of Thailand

The BOT supervises all financial institutions in Thailand. It was first set up as the Thai National Banking Bureau. The *Bank of Thailand Act* was first promulgated on 28 April 1942, vesting the BOT with the responsibility for all central banking functions. The BOT commenced operations on 10 December 1942.

The *Bank of Thailand Act, B.E. 2485 (1942)* was amended by *B.E. 2551 (2008)* to put emphasis on the BOT's social responsibility, to create a mechanism to guard against economic crisis, as well as to set up BOT's decision-making process to ensure good

²¹ Footnote 13. http://www2.mof.go.th/government_agencies.htm

governance and transparency in the organization.²² Thus, the public is now able to audit and increase the understanding of the BOT's operations. The *Bank of Thailand Act* (4th) B.E. 2551 (2008) came into force on 4 March 2008.

The BOT's major roles and responsibilities are:²³

- (i) Print and issue banknotes and other security documents;
- (ii) Promote monetary stability and formulate monetary policies;
- (iii) Monitor the foreign currency reserve;
- (iv) Provide banking facilities for the government;
- (v) Provide banking facilities for financial institutions;
- (vi) Supervise and examine financial institutions;
- (vii) Establish or support the establishment of the payment system;
- (viii) Manage the country's foreign exchange rate under the foreign exchange system and manage assets in the currency reserve according to the *Currency Act*;
- (ix) Control the foreign exchange according to the *Exchange Control Act*; and
- (x) Manage the BOT's assets.

3. Securities and Exchange Commission

The SEC was established under the *Securities and Exchange Act* (SEC Act) B.E. 2535 (1992) on 16 May 1992. The SEC Act B.E. 2535 (1992) was amended by SEC Act B.E. 2551 (2008), which came into effect on 5 March 2008.²⁴

The objectives of the SEC are to supervise and develop both primary and secondary capital markets, as well as financial- and securities-related participants and institutions. Its primary roles are to formulate policies and rules and regulations regarding the supervision, promotion, and development of securities businesses, as well as other activities pertaining to the securities business. The policy objectives of the SEC in supervising and developing the capital markets are to:

- (i) Maintain fairness in capital market and financial market;
- (ii) Develop and enhance efficiency of the capital and financial markets;
- (iii) Maintain long-term stability of the financial system; and
- (iv) Strengthen international competitiveness of the Thai capital market.

The SEC's responsibilities in supervising the Thai capital market can be summarized into seven major areas:

a. Securities Issuance and Business Takeover

With regard to securities issuance, the SEC Act allows the business sector to issue and offer for sale various kinds of securities, namely equity, debt instruments and hybrid instruments, to mobilize funds from the public. The issuance and offer must be beneficial to the country's economic and social prosperity. Under the SEC Act, eligible equity or hybrid instrument issuance is restricted to public limited companies only (including the incorporators of a public limited company who can issue and

²² Footnote 4. http://www.bot.or.th/English/LawsAndRegulations/DocLib_EngLaw/Law_E01_Bot.pdf

²³ Footnote 4. <http://www.bot.or.th/English/AboutBOT/index/Pages/RolesAndResponsibilities.aspx>

²⁴ Footnote 8. <http://www.sec.or.th/view/view.jsp?lang=en>; http://www.sec.or.th/laws_notification/Content_0000000179.jsp?categoryID=CAT0000021&lang=en

offer equities), while issuance of debt instruments can be undertaken by both public limited companies and limited companies.

With respect to takeover and change of control, the Takeover Sections of the SEC Act provide shareholders with adequate information and fair treatment.

i. Information Disclosure

A person acquiring or disposing shares, share warrants, Non-Voting Depository Receipts and convertible securities, which can be converted into shares of companies having their securities listed on the SET or the Market for Alternative Investment (MAI), or of a public limited company, must file an acquisition or disposition report (Form 246-2) with the SEC within 3 business days when such acquisition or disposition causes the aggregate holding of the same type of security to reach or pass a multiple of 5% of the total number of voting rights of the business.

ii. Tender Offer

A person who acquires or holds securities of a business up to the point at which the change in control of a business takes place must issue a tender offer to provide all securities holders with an equal opportunity to sell their securities to the offerer. The securities holders must also receive adequate information and advice to assist them in making such decision. Directors are required to make recommendations with respect to the proposal.

The trigger points which are regarded as changes in the control of a business, and which require the making of a tender offer to purchase all securities, are defined at 25%, 50% and 75% of the total number of voting rights of the business. The offer price for the tender offer must be the same for all shareholders or securities holders, and must not be less than the highest price at which the acquirer had acquired such securities within 90 days prior to the tender offer.

Apart from the mentioned mandatory offer, a person may also make a voluntary offer to purchase and hold 25% or more of the securities of a business under the provision of the Takeover Sections of the SEC Act.

b. Securities Businesses

Under the SEC Act, securities businesses refer to

- (i) securities brokerage;
- (ii) securities dealing;
- (iii) securities underwriting;
- (iv) investment advisory services;
- (v) mutual fund management;
- (vi) private fund management;
- (vii) securities borrowing and lending;
- (viii) securities financing;
- (ix) inter-dealer brokerage;
- (x) venture capital fund management; and
- (xi) other businesses relating to securities as specified by the Minister of Finance upon the recommendation of the SEC.

The SEC Act requires all operators of securities businesses to be licensed by the Minister of Finance. Applications and screening are done at the SEC. Requirements include initial capital adequacy; a fit-and-proper capability for management, directors and controlling shareholders; and an assessment of internal control, risk management and supervisory systems.

In addition, the SEC supervises securities businesses according to their risks, whether they comprise financial risk, operational risk, internal control risk, customer relation risk, information technology risk, and other areas. Each company must have sufficient capital to withstand business risk, whereby different weights are assigned to each business area, with the main objective of maintaining the stability and creditability of the whole system rather than the survival of an individual securities company.

SEC also pays particular attention to client treatment and the structure of the securities businesses in fostering efficiency in securities trading and maintaining competition at an appropriate level.

c. Derivative Businesses

The SEC approves, licenses and supervises derivatives businesses, including the derivatives exchange, clearing house and business operators, in accordance with the Derivatives Act B.E. 2546 (effective 6 January 2004).

d. Investment Management Businesses

Investment management businesses offer an important alternative investment vehicle for investors, with the advantage of risk diversification, and the employment of professionals who are experts in investment. The types of investment management businesses include mutual fund management, private fund or discretionary fund, pension fund, and provident fund management (for both retail investors and institutional ones). Investment management businesses are entrusted to take care of the assets of public investment, and the SEC conducts stringent supervision on them to make sure that they are knowledgeable and capable of performing their fiduciary duties in managing clients' assets with honesty, integrity and for the utmost benefit of investors.

e. The Exchanges

Under the SEC Act, the establishment of any organized securities trading center requires a license from the SEC. Presently, there are four securities exchanges in the Thai capital market comprising of two stock exchanges (the SET and MAI), one bond exchange (Bond Electronic Exchange, BEX), and one derivative exchange (Thailand Futures Exchange, TFEX).

i. The Stock Exchange of Thailand

The SET was established in 1975 under the *Securities Exchange of Thailand Act B.E. 2517 (1974)* and its members are securities companies. Trading of securities in the SET is in scripless form and is settled between brokers and custodian accounts. Physical securities must be converted into scripless form prior to trading in the SET.

ii. The Market for Alternative Investment

The MAI, a subsidiary of SET, officially commenced operation on 21 June 1999. MAI's main objectives are to create new fund-raising opportunities for small- and

medium-sized enterprises (SMEs), as well as to provide a greater range of investment alternatives for investors.

iii. Bond Electronic Exchange

BEX, also a subsidiary of SET, was launched on 26 November 2003. Its main role is to support the secondary market for bond trading. As the majority of bond trading is done in the over-the-counter (OTC) market, BEX's objective, therefore, is to expand bond activities to individual investors.

iv. Thailand Futures Exchange

TFEX, another subsidiary of SET, was established on 17 May 2004 as an exchange for trading of derivatives products. TFEX's trading method centers around electronic trading. All orders and quotes are entered into a central order book where they are automatically sorted by type, price and entry time. Settlement in TFEX is through the electronic trading and clearing platform using NASDAQ OMX technology.

f. Unfair Securities Trading Practice

The SEC website has provided information on inspection and enforcement of rules on securities trading practice.

i. Inspection

In order to maintain confidence and fairness in the Capital Market, the SEC closely monitors securities companies and the entities under supervision. In monitoring regulated entities' compliance with rules and regulations, the SEC has an inspection program that covers regulated entities on a routine periodic basis, based on risk assessment from previous inspections and reports, as well as inspection upon complaint. If regulated entities fail to comply with the rules and regulations, the SEC will pursue the matter through legal proceedings.

When there are reasonable grounds to suspect that there is an offence against provisions under the SEA, SEC competent officers are empowered to conduct on-site inspections at the premises of regulated entities or any other persons or locations that possess or hold relevant information, documents, or evidence in relation to the offence. The investigative powers under the SEA are sufficient for the SEC to obtain all information necessary for the investigation. The offences include insider trading, price manipulation, false or misleading disclosure, operating a securities business without a license, and fraud by company executives etc.

In case of unfair securities trading practices, the SET is a front-line regulator responsible for real-time surveillance of securities trading. The SET's responsibilities include monitoring unusual volumes or prices of listed securities, demanding updated statements from listed companies and conducting a preliminary review before submitting the case to the SEC.

ii. Enforcement

Regarding law enforcement, the SEC takes strict enforcement action against wrongdoers in terms of both administrative and criminal sanctions. Where there has been non-compliance, the SEC has the power to issue notices for rectification, warning, probation, suspension of approval for a specified period of time or revocation of approval. These administrative sanctions together with criminal sanctions not

only ensure compliance with the law, but also raise the standards of operators and approved persons in the capital market by making them conduct their businesses cautiously and prudently.

In case of offences that do not have significant or wide spread impact, the SEC can fine the wrongdoers by presenting the case to the Settlement Committee, appointed by the Minister of Finance. In this regard, the wrongdoers must agree to be fined by the committee and the SEC acts as a coordinator to the Settlement Committee, which comprises representatives of the Royal Thai Police, the Bank of Thailand, and the Fiscal Policy Office. The fine will be remitted as revenue to the state.

In case of offences that have significant impact on the public or cannot be fined by the Settlement Committee or those where the offenders refuse to provide written consent to appear before the Settlement Committee, the SEC will file criminal complaints with an inquiry official of the Department of Special Investigation or Royal Thai Police for further investigation and legal proceedings.

The SEC has no power in pursuing legal civil proceedings to claim compensation on behalf of investors, so investors must pursue legal civil proceeding by themselves. However, if investors have suffered damages or have disputes with securities business intermediaries for breach of contract or non-compliance with securities law or provident fund law, they may apply for arbitration procedure to settle their disputes.²⁵

g. Trust Business

Commercial banks, financial institutions created by other specific laws and legal entities as specified by the SEC may apply for an approval to undertake trust business. In granting an approval, the SEC shall consider the applicants' fit and proper qualities in relation to their financial condition, operating system and other qualifications as stipulated by the SEC. (verbatim from SEC website).

B. Securities Issuance Rules in Brief

Box 2.1 Securities Issuance

- Approval of Securities Offering
 - Shares Offering
 - Issuance and Offering of Equity by Foreign Issuer
 - Debentures Offering
 - Domestic Debenture
 - Plain Debt Securities
 - Structured Debentures
 - Securitization
 - Overseas Debenture
 - Foreign Issuer Debenture
 - SUKUK Offering
 - Convertible Securities Offering

continued on next page

²⁵ Securities and Exchange Commission Thailand. http://www.sec.or.th/sec/Content_0000000324.jsp?categoryID=CAT0000430&lang=en

Box 2.1 continuation

Convertible Debenture
 Warrant
 Transferable subscription right
 Derivatives Warrant
 Others Securities Issuance
 Others Securities Issuance
 Exchange Traded Options
 Beneficial on Underlying Securities
 Others
 Approval/Disclosure/After Sell Duties for ESOP
 Approval/Disclosure/After Sell Duties for ESOP of Foreign Companies
 Filing of the registration statement and the draft prospectus
 lodgment Registration Statement for debenture issuance pursuant
 (For the issuers who ask for approval to offer debt securities subject to current notification)
 (For the issuers being granted approval to offer debt securities subject to Kor.Yor 31/2549 notification)
 Registration Statement for SUKUK
 Filing the registration statement
 Filing the draft prospectus and distribution of the information before selling of securities
 Governance of publicly traded company pursuant to chapter 3/1
 Company exempt from chapter 3/1
 Related parties transaction
 Acquisition or dispose of asset
 Report on the interest of director, executive and related person
 COMPANY SECRETARY/DOCUMENT STORAGE
 After Sell Duties
 Securities Saling Report
 Securities Settlement and Securities Registrar
 Reports of securities holdings
 Disclosure of financial position and business operation of the company
 Report in accordance with section 57
 Others
 Subscription and Underwriting of securities
 Fees
 Others

Source: Securities and Exchange Commission Thailand. Footnote 8. http://capital.sec.or.th/webapp/nrs/nrs_print_en.php?printfrom=R&ref_id=72

1. Approval for Securities Offering

Provisions of the SEC Act and other regulations related to bond issuance can be found in the SEC website.²⁶ Specific provisions can be found in:

(i) Chapter 2 on Issuance of Securities²⁷

- (a) Division 1 Approval for the Offering of Newly Issued Securities (Sections 32–38)
- (b) Division 2 Debentures (Sections 39–40)
- (c) Division 3 Issuance of Secured Debentures (Sections 41–49)
- (d) Division 4 Register and Transferability (Sections 50–55)
- (e) Division 5 Disclosure of Information and Auditor (Sections 56–62)

²⁶ Footnote 8. http://www.sec.or.th/securities_issuance/Content_000000007.jsp?categoryID=CAT0000066&lang=en

²⁷ Footnote 8. http://www.sec.or.th/laws_notification/Content_0000000312.jsp?categoryID=CAT0000015&lang=en; http://www.sec.or.th/laws_notification/Content_0000000313.jsp?categoryID=CAT0000015&lang=en; http://www.sec.or.th/laws_notification/Content_0000000314.jsp?categoryID=CAT0000015&lang=en; http://www.sec.or.th/laws_notification/Content_0000000316.jsp?categoryID=CAT0000015&lang=en; http://www.sec.or.th/laws_notification/Content_0000000317.jsp?categoryID=CAT0000015&lang=en

(ii) Chapter 3 Public Offering of Securities (Sections 63–89)²⁸

- (a) Division 4 Listed Securities (Sections 189–200)

(iii) Chapter 6 Over-the-Counter Centre and Futures and Options Centre

- (a) Division 1 Over-the-Counter Centre (Sections 204–217)
- ²⁹

(iv) Chapter 7 Institutions Related to Securities Business

- (a) Division 1 Clearing House, Securities Depository Centre and Securities Registrar (Sections 219–229)
- ³⁰

The *Securities and Exchange Act B.E. 2535* (1992) prohibits companies from offering newly issued shares and other securities for sale without prior approval from the SEC in compliance with the rules and regulations issued by the SEC Board, except for the rights offering to existing shareholders. This provision allows the SEC to put in place rules and regulations, and consider the merits of the securities to be offered. Securities offering can be classified by types of securities as follows:

- (i) Shares
- (ii) Derivative warrants
- (iii) Debt securities
- (iv) Overseas debentures
- (v) Warrants
- (vi) Securitization
- (vii) Securities issuance and offering by foreign issuer
- (viii) Foreign exchange bond
- (ix) *Sukuk*

On the other hand, private placement of debt securities with only limited distribution (not exceeding 10 investors) is exempt from SEC filing for registration, is defined in the Notification of the Capital Market Supervisory Board No.TorChor.9/2552 (2009) on the Application for and Approval of Offer for Sale of Newly Issued Debt Securities.³¹

2. Disclosure of Information

In offering newly issued securities for sale, companies shall apply for an approval from the SEC and disclose information to the investing public for decision making. However, the offering of existing securities by its holders can be done without SEC approval on the condition that offerors shall disclose information prior to offering securities for sale. Before offering securities to the public, offerors, who can be companies or existing shareholders, shall file a registration statement and a draft prospectus with the SEC to give investors time to study such information. However, some types of securities offering are not required to file such documents if the offering involves a limited number of investors (not exceeding 10 investors). Offering of securities for sale is allowed upon:

²⁸ Footnote 8. http://www.sec.or.th/laws_notification/Content_0000000318.jsp?categoryID=CAT0000015&lang=en; http://www.sec.or.th/laws_notification/Content_0000000305.jsp?categoryID=CAT0000015&lang=en

²⁹ Footnote 8. http://www.sec.or.th/laws_notification/Content_0000000280.jsp?categoryID=CAT0000015&lang=en

³⁰ Footnote 8. http://www.sec.or.th/laws_notification/Content_0000000283.jsp?categoryID=CAT0000015&lang=en

³¹ Securities and Exchange Commission Thailand. <http://capital.sec.or.th/webapp/nrs/data/4607se.pdf>

- a. SEC approval in case of newly issued shares; and
- b. The effectiveness of the registration filing. During the filing process, information shall be disclosed with discretion and within the limits of the permitted scope.

3. Post-Offering Duties

After offering securities for sale to the public, companies shall undertake securities settlement with the holders in accordance with SEC regulations and disclose information on a continual basis to give investors information for making an investment decision. Information of securities subject to public disclosure includes:

- (i) Report of securities selling.
- (ii) Report of rights exercising on convertible securities, i.e., warrants and convertible debentures.
- (iii) Report of financial condition and operational performance, consisting of financial statements and annual reports (Form 56-1 and 56-2).
- (iv) Report of securities holding of the issuing company management.

4. Regulatory Transaction Reporting Requirements

The SEC stipulates that all licensed dealers must report transactions in each bond to the ThaiBMA within 30 minutes after trade. Practically, trades are submitted to ThaiBMA within 15 minutes on average. All reports are scrutinized by the Monitoring and Surveillance Department to ensure accuracy and integrity prior to compilation and dissemination to the general public and for mark-to-market purposes.

C. Filing and Approval Criteria

1. Plain Debt

Table 2.1 Filing and Approval Criteria for Plain Debt

A. Filing ^a	
1. Public Offering (PO)	✓: require filing to SEC
2. Non Retail Investor (NRI)	✓: require filing to SEC Min. disclosure
3. Exempt	≤ 10 persons T-bill, Gov't bond, MOF bond, BOT bond
B. SEC Approval criteria	
Thailand	
4. PO	✓: requires SEC approval
4.1. Eligible entities	Local company and foreign company ^a
4.2. Others	Local Issuer Bath bond and foreign exchange (FX) bond : 1. Never breach to offering rule 2. Qualified executive without prohibited qualification 3. Disclose the latest annual and quarter financial statement 4. Rated by accepted credit rating agency (CRA) 5. Register with Thai Bond Market Association 6. FX bond: issuer required approval from BOT in relation to FX control (additional)

continued on next page

Table 2.1 continuation

A. Filing ^a	
B. SEC Approval criteria	Thailand
4.2. Others	Foreign Issuer Baht bond: approval from MOF FX bond: 1. Never breach to offering rule 2. Disclose financial status (IFRS/FAS/US GAAP/other acceptable standard) 3. Contract person in Thailand 4. Offering debt in Thailand is not beach the issuance's country law 5. IOSCO-signatory A 6. Issuer required approval from BOT in relation to FX control
5. NRI	✓: approval in general Lighter
5.1. Eligible entities	local company and foreign company
5.2. Others	1. Limited transferability 2. Rated by accepted CRA 3. Register with Thai Bond Market Association (≤ 10 persons, issuer is not required to comply with 2. and 3.)
^a Filing means SEC filing of the registration statement and draft prospectus. Notes: ✓ = 'Yes,' 'exists' or 'required' BOT = Bank of Thailand; MOF = Ministry of Finance; T-bill = Treasury bill; SEC = Securities and Exchange Commission Source: Securities and Exchange Commission Thailand.	

2. Complex Debt

Table 2.2 Filing and Approval Criteria for Plain Debt and Complex Debt

A. Filing	
1. Public Offering (PO)	✓: requires filing with SEC
2. Non Retail Investor (NRI)	✓: requires filing with SEC Min. disclosure
3. Exempt	≤ 10 persons T-bill, Gov't bond, MOF bond, BOT bond
B. SEC Approval criteria	Thailand
4. Underlying	local securities, local or foreign securities index, currency, gold, cash in/out flow, credit link, credit default
5. PO	✓: requires approval from SEC
5.1. Eligible entities	Local company - derivative dealer - Commercial bank (underlying = gold, FX) - cash in/out flow or main business are related to the reference underlying
5.2. Others	1. Never breach to offering rule 2. Qualified executive w/o prohibited qualification 3. Disclose the latest annual and quarter financial statement 4. Rated by accepted CRA 5. Register with Thai Bond Market Association 6. Redeemed value > 80% of par value 7. Issuer is not a related party of the underlying company.
6. NRI	✓: requires approval from SEC
6.3. Eligible entities	Local company - derivative dealer
6.4. Others	1. Limited transferability 2. Rated by accepted CRA 3. Register with Thai Bond Market Association (≤ 10 persons, issuer is not required to comply with 2. and 3.)
^a International financial institution or foreign government or multi-national corporation in ASEAN+3 countries. Notes: ✓ = 'Yes,' 'exists' or 'required' BOT = Bank of Thailand; IFRS = International Financial Reporting Standards; IOSCO = International Organization of Securities Commission; FAS = Financial Accounting Standard; MOF = Ministry of Finance; T-bill = Treasury bill; SEC = Securities and Exchange Commission; US GAAP = Generally accepted accounting principles (United States) Source: Securities and Exchange Commission Thailand.	

3. Regimes in Place in the Jurisdiction

Table 2.3 Regimes in the Thai Bond Market

	YES	NO
Private Placement Regime	X	
Institutional Offerings Regime	X	
Integrated Disclosure Regime ^a (including continuous disclosure)	X	
Shelf Registration Regime	X	

a An integrated disclosure regime allows the issuer to incorporate by reference continuous disclosure documents into its public offering documents, thereby easing disclosure burden of public offerings. It allows the qualified issuer to file disclosure documents for a new public offer by incorporating continuous disclosure documents by reference and minimizes the redundancies.
Source: ADB consultant.

4. Minimum Lead Time for Registration Approval

Minimum lead time refers to the number of business days for registration approval.

Table 2.4 Minimum Lead Time for Registration Approval

	TIME PERIOD (Months)
How long is the time period set which the regulator has to approve or disapprove the prospectus?	Offering corporate bond to institutional investors and high net worth investors effective within the next business day from the date of filing prospectus in full. Offering corporate bond to the public (public offering) effective after the end of the fourteenth day period from the day the office receives prospectus in full.
How long, on average, is the prospectus reviewing period in your jurisdiction? (From the time of application until the approval or disapproval by the regulator.)	About 20–30 days.

Source: Securities and Exchange Commission Thailand.

5. Summary of Regulation for Issuing and Offering of Corporate Bonds

Corporate bond offering regulations are summarized in Table 2.5.

Table 2.5 Regulations on Corporate Bond Offering

	Private Placement (PP)		Public Offering (PO)
	PP (Narrow Distribution/Small Size/Short term)	PP (Institutional Investor [II] and High Net Worth Investor [HNWI])	
Distribution	Narrow Distribution 1. < 10 person or 2. For debt restructuring or 3. Overseas institutional investors 4. Convertible bond sold to the existing shareholders or 5. Total number of the bill issued are less than 10	II and HNWI	General investors including individuals
Issue size (Stock Exchange of Thailand rule for Listing qualification) ^a	In case of small (less than THB100 million), Cannot be listed (Unlisted)	Not less t than THB100 million, can be listed.	Not less than THB100 million, can be listed
Short-term bills	SEC filing not required (Exempt)	Requires filing with SEC	Requires filing with SEC

continued on next page

Table 2.5 continuation

	Private Placement (PP)		Public Offering (PO)
	PP (Narrow Distribution/Small Size/Short term)	PP (Institutional Investor [II] and High Net Worth Investor [HNWI])	
Securities and Exchange Commission (SEC) filing of registration statement and draft prospectus	SEC filing not required (Exempt)	SEC filing required but light (Free form, 1-day process) Notification of the capital market supervisory board no. TorChor.10/2552 Clause 18 (1)	SEC filing required (full form, full process)
Continuous Disclosure requirement	Not required (Exempt)	Require same disclosure at the same time that send to lead regulator	Requires annual updated filing, including financial statement, to SEC
Rating	Not required (Exempt)	Required, but Issue, Issuer, Guarantor rating (any can be used)	Required. Long term: issue/ guarantor rating Short term: issue/ issuer/ guarantor rating
Thai Bond Market Association registration	Not required (Exempt)	Required (newly issued bond)	Required (newly issued bond)
Bond representative	Not required (Exempt)	Not required (Exempt)	Required, except for short-term bond

^a Regulations of the Stock Exchange of Thailand on Listing of Debt Instruments as Listed Securities
Source: Securities and Exchange Commission Thailand.

- a. The bond can be offered for sale by public offering (PO) or private placement (PP). PP generally means to offer for sale to institutional investors (II), high net worth investors (HNWI), and specific investors.
- b. Approval from the SEC is required for the offer for sale by PO. A full filing form (a specific form prescribed by the SEC) and draft prospectus have to be submitted to the SEC.
- c. PP (narrow distribution/small size) is exempt from filing requirement.
- d. PP (II and HNWI) is exempt from full filing requirement. (Light requirement remains.)
- e. The concept of II or Qualified Foreign Institutional Investor (QFII) does not only apply to securities available for sale in the exchange market but also applies to debentures issued by PP.
- f. A credit rating is also required for an offer for sale by a PO and PP.
- g. The newly issued bond must be registered with the ThaiBMA.
- h. A bond representative is required to be appointed and filed with the SEC, except for short-term bonds.
- i. An annual update, including a financial statement, is required to be filed with the SEC.

6. Debt Securities under Exemption from Securities and Exchange Commission Filing

These notifications (Box 2.2 and Box 2.3) provide the exemption from filing of Registration Statement for the Offer for Sale of Debt Securities.

Box 2.2 Notification on Characteristics of Private Placement/Exempt Rule

Notification of the Capital Market Supervisory Board No. TorChor. 9/2552
Re: Application for and Approval of Offer for Sale of Newly Issued Debt Securities

Chapter 2 Private Placement of Debt Securities

Division 1 Characteristics of Private Placement

Clause 32 An offer for sale of bonds in any of the following manners shall be deemed private placement:

- (1) An offer made to institutional investors or high net worth investors, excluding an offer made to institutional investors or high net worth investors with registration of transfer restriction among not exceeding ten investors within any four-month period which shall fall under (2);
- (2) An offer made specifically to not exceeding ten investors within any four-month period;

In cases where the securities depository center, custodian, securities broker, securities dealer or any person holds bonds on behalf of other persons, the counting of the number of investors under the first paragraph shall be based on the real owner of such bonds.

- (3) An offer made to the person being the company's creditor prior to the offer for sale of bonds for the purpose of debt restructuring;
- (4) An offer granted an exemption from the Office, where the approved person shall demonstrate that:
 - (a) There is reasonable and appropriate cause;
 - (b) Such offer for sale shall not affect investors at large; and
 - (c) There are sufficient measures for investor protection.

Clause 33 In case of requesting an exemption for an offer for sale of newly issued bonds under Clause 32(4), the person requesting an exemption shall demonstrate the reasonable and appropriate cause of such case, the non-existence of effects on investors at large and the availability of sufficient measures for investor protection, and the Office may grant an exemption for application of the rules or conditions prescribed in this Chapter, whether totally or partially, to such offer for sale of bonds as deemed necessary, by taking into account the suitability and sufficiency of measures for investor protection.

Clause 34 Bills issued in any of the following manners shall be deemed issuance of bills for private placement:

- (1) Bills issued by the securities finance institution or any other person as specified by the Office with the purpose to borrow money from institutional investors or high net worth investors;
- (2) Short-term bills offered to institutional investors or high net worth investors;
- (3) Bills which do not fall under (1) or (2) in the amount of not exceeding ten bills at any time when counting all types of bills issued by the company.

For the purpose of the provisions in this Clause, the term "institutional investor" under the first paragraph shall not include the persons prescribed in Clause 5(3) of the Notification of the Securities and Exchange Commission No. KorChor. 4/2552 Re: Exemption from Filing of Registration Statement for Offer for Sale of Debt Securities dated 13 March 2009.

Division 3 After-Approval Conditions for Private Placement of Debt Securities

Clause 37 In case of an offer for sale of all types of newly issued debt securities to institutional investors established under Thai law or high net worth investors under Clause 32(1), the approved person shall comply with the conditions under Clause 38, Clause 39 and Clause 40.

Clause 38 Prior to each offer for sale of newly issued debt securities, the approved person shall provide any of the following credit rating arrangement by the credit rating agency approved by the Office:

- (1) Credit rating of debt securities offered for sale each time (issue rating);
- (2) Credit rating of the debt securities guarantor (guarantor rating), only in cases where the guarantor is obliged to liabilities jointly with the debtor without revocability before the debt securities maturity, including credit rating of the provider of aval (guarantee by person) of principle and interest of bills in full amount without condition; or

continued on next page

Box 2.2 continuation

(3) Credit rating of the approved person (issuer rating), excluding the case of an offer for sale of subordinated bonds.

The provisions related to granting of exemption for credit rating arrangement as prescribed in the second paragraph of Clause 21 shall also apply to the case under the first paragraph.

Clause 39 After the issuance of debt securities, the approved person shall provide continuous arrangement of credit rating of debt securities in accordance with the rules under Clause 38 until the claim for repayment of such debt securities is terminated. Except where it is necessary and appropriate, the Office may grant an exemption for arrangement of credit rating of debt securities and may also prescribe the timeframe or conditions thereof, by taking into consideration the necessity of credit rating information for investors.

Clause 40 The approved person shall file an application with the Thai Bond Market Association for registration of the issued and offered debt securities within thirty days after the issuing date.

Clause 41 In case of an offer for sale of short-term bonds or bills to institutional investors or high net worth investors, the approved person may make unlimited offer for sale of short-term bonds or bills subject to the registration statement filed for an offer for sale of short-term bonds or bills to institutional investors or high net worth investors as prescribed in the Notification of the Capital Market Supervisory Board concerning filing of registration statement for offer for sale of debt securities, but any offer shall be made within one year after the effective date of such registration statement.

Division 4 Additional After-Approval Conditions for Private Placement of Bonds

Clause 42 Prior to an offer for sale of bonds, the approved person shall obtain an explicit resolution from the company's board of directors approving the issuance of bonds. Except where the applicant is a public limited company, the resolution for the issuance of bonds shall be obtained in compliance with the law on public limited company.

The provisions in the first paragraph shall not apply to the case where the company is required to issue bonds according to the rehabilitation plan under the bankruptcy law which has been approved by the court, or any other case granted an exemption by the Office.

Clause 43 In case of secured bonds or bonds provided with the bond holder representative, the approved person shall provide the bond holder representative whose name is in the list of persons qualified to be the bond holder representative in accordance with the Notification concerning qualifications of bond holder representative and authority of bond holder representative.

Clause 44 The approved person shall take the following actions:

(1) Having the bonds to be issued and offered for sale meet the following characteristics:

(a) Being registered bonds and having a statement in the certificate of bonds offered for sale each time that the bond issuer shall not accept transfer registration of bonds in any level if such transfer is inconsistent with the transfer restriction as indicated and registered with the Office;

(b) Having the characteristics in accordance with Clause 17(1), (2) and (3);

(c) Complying with the rules prescribed in Clause 18 and Clause 19 in case of an offer for sale of subordinated bonds or perpetual bonds, as the case may be;

(d) In case of an offer for sale of bonds to institutional investors established under Thai law or high net worth investors under Clause 32(1), having the terms and conditions with at least the particulars as prescribed in Section 42(1) to (9) and complying with the first paragraph of Clause 29;

(2) In case of private placement of bonds under Clause 32(2), (3) or (4), the approved person shall not advertise an offer for sale of newly issued bonds and reserved shares. If the distribution of offer documents is made, the approved person shall distribute such documents only to persons with the characteristics or in the limited number as prescribed in Clause 32(2), (3) or (4) as granted approval;

(3) Offer documents (if any) shall contain a statement indicating the transfer restriction under (1)(a) and in case of an offer for sale of subordinated bonds, such subordination shall be clearly indicated.

Clause 45 In cases where any person shows his intention to the approved person to register transfer of bonds, the approved person shall make verification of such transfer. If such transfer is inconsistent with the transfer restriction registered with the Office, the approved person shall not register such transfer, except for transfer by inheritance.

In cases where the approved person has provided the bond registrar, the approved person shall have the bond registrar comply with the rules prescribed in the first paragraph.

continued on next page

Box 2.2 continuation

Division 5 Additional After-Approval Conditions for Private Placement of Bills

Clause 46 Prior to an offer for sale of bills, the approved person shall obtain an explicit resolution from the company's board of directors approving the issuance of bills, except for the case where the company is required to issue bills according to the rehabilitation plan under the bankruptcy law which has been approved by the court or any other case granted an exemption by the Office.

Clause 47 The approved person shall provide a statement that "These bills are securities and approved for private placement" on the face of the bills. In case of the issuance of bills under Clause 34(1) or (2), the bill issuer shall provide additional statements saying "Being offered for sale only to institutional investors or high net worth investors" and "Non-negotiable" or "With the purpose of transfer among institutional investors or high net worth investors" or any other statement with similar meaning.

Clause 48 In case of an offer for sale of bills under Clause 34(3), the approved person shall not advertize such offer. If the distribution of offer documents is made, the approved person shall distribute such documents only to persons with the characteristics or in the limited number as prescribed in Clause 34(3) as granted approval.

Notified this 13th day of March 2009.

Remark: The rationale for issuing this Notification is to prescribe rules on approval of an offer for sale of newly issued debt securities by a company established under Thai law or a branch of a foreign commercial bank and, so as to promote development and growth of Thai debt securities market, to relax rules on approval of an offer for sale of debt securities to limited group of investors which will help facilitate fund raising through debt securities issuance of the private sector, as well as to re-define an offer for sale to limited group of investors to include an offer for sale of debt securities to institutional investors or high net worth investors without limitation of offer value to be in accordance with international standards.

Note: Emphases added by authors.

Source: Securities and Exchange Commission Thailand. Footnote 45. <http://capital.sec.or.th/webapp/nrs/data/4607se.pdf>

Box 2.3 Notification on Exemption from Filing of Registration Statement for the Offer for Sale of Debt Securities

Notification of the Securities and Exchange Commission No. KorChor. 4/2552 (2009)
Re: Exemption from Filing of Registration Statement for the Offer for Sale of Debt Securities

Chapter 1 Debt Securities under Exemption

Clause 5. The provisions under Chapter 3 of the Securities and Exchange Act B.E. 2535 (1992) concerning public offering of securities shall not apply to the following debt securities:

- (1) corporate bonds where principle and interest are guaranteed by the Ministry of Finance, but not including convertible bonds;
- (2) debt securities offered for sale by securities companies licensed to undertake securities business in the category of securities dealing where the issuer has adequately provided continual information disclosure;
- (3) bills issued and offered for sale with the purpose to borrow money from the following persons:
 - (a) commercial banks, finance companies or credit foncier companies under the law on financial institution business;
 - (b) financial institutions established under specific law;
 - (c) any other person prescribed by the Office.

Source: Securities and Exchange Commission Thailand. Footnote 45. <http://capital.sec.or.th/webapp/nrs/data/4603se.pdf>

D. Bond Electronic Exchange's Rules Related to Bond Listing, Disclosure, and Trading

BEX's rules pertaining to bond listing, disclosure, and trading include the "Notification of the Stock Exchange of Thailand on Trading of Debt Instruments" (2003) and the "Regulations of the Stock Exchange of Thailand on Listing of Debt Instruments as Listed Securities" (2004). Both can be found in the SET website³²

E. Thai Bond Market Association's Rules related to Trading, Reporting, and Registration

ThaiBMA's rules on trading, reporting, and registration are encapsulated in the "Standard of Practices for the Bond Market."³³

F. Bank of Thailand's Regulations on Non-resident

Non-residents may invest in Thai government bonds (TGBs) without any restrictions. Repatriation of investment funds and returns on such investment can be freely remitted upon submission of supporting evidences to authorized financial institutions in Thailand. Investment in TGBs is also eligible for foreign exchange hedging with authorized financial institutions in Thailand. Transfers in Thai baht relating to investment in TGBs must comply with the present foreign exchange regulations governing non-resident baht accounts.

G. Credit Rating Requirements

Credit rating is required for corporate bonds PO or PP as stated above in II.C.5.

Global rating agencies have assigned the above long-term foreign currency ratings for Thailand (see Table 2.6). The SEC licenses rating agencies that specialize in Thai debt. Rating definitions vary from agency to agency. Rating selection involves information gathering, analysis, and monitoring of the financial health of an issuing entity. TRIS Rating covers financial institutions, private companies, and state enterprises. Users can also find information on the rationale for each rating level.

Table 2.6 Long-Term Foreign Currency Ratings

S&P	BBB+	Dec 2010
Moody's	Baa1	Oct 2010
Fitch	BBB	Apr 2010
R&I	BBB	Apr 2011
Source: AsianBondsOnline.		

³² Footnote 7. http://www.set.or.th/dat/content/rule/en/BorSorSaw0114_1_EN.pdf; http://www.set.or.th/dat/content/rule/en/BorJorRor0200_EN.pdf

³³ Footnote 3. http://www.thaibma.or.th/sro/topic/Standard_of_Practices_for_the_Bond_Market.pdf

H. Exemptions for Private Issues (Private Placement)

Corporate bond offerings may be exempted from the obligation to file disclosure documents with the SEC only when the offer or sale of corporate bonds is limited to not more than 10 investors, as specified in the relevant SEC Rules and detailed in Box 1.1 in I.G.1.a. Key determinants for a PP are when the offer is made to (1) institutional investors or high net worth investors or (2) to a maximum of 10 investors within any four-month period. In reality, there is a condition in the secondary market that only allows institutional investors to buy and sell these bonds in the PP market. This type of bond is negotiated and traded off the exchange floor, referred to as OTC trading.

Also, see II.C.5 above.

I. Minimum Lead Time for Registration Approval

See II.C.3 to 4 above.

J. Availability of Shelf Registration and Associated Documentation Requirements

See II.C.3 above and the SEC Act B.E. 2535 (1992) Chapter 3 on Public Offering of Securities (Section 63-89).³⁴

K. Regulated Suspension Period

See II.C.3 to 4 above.

Chapter 3 on Public Offering of Securities Section 67 of the SEC Act B.E. 2535 (1992) stipulates that

Subject to the provisions of Section 68, a registration statement and draft prospectus shall be effective upon the lapse of forty-five days after the receipt of such registration statement and prospectus by the Office, except where the SEC specifies an effective date before such period.

L. Other Requirements

Specific requirements for the Thai market have been covered in the other sections of this chapter.

M. Continuous Disclosure Rules or Requirements

See II.C.3 to 5 above.

³⁴ Footnote 8. http://www.sec.or.th/laws_notification/Content_0000000318.jsp?categoryID=CAT0000015&lang=en

N. Restrictions for Investors

There are no government restrictions, particularly on market-entry requirements, for investors investing in the Thai bond market.

See I.L.1 to 2.

O. Non-Resident Requirements and Restrictions

There are no government restrictions, particularly on market-entry requirements, to foreign investors investing in the Thai bond market, but there are a few notable restrictions. The legal basis for exchange control in Thailand is derived from the *Exchange Control Act B.E. 2485 (1942)* and Ministerial Regulation No.13, B.E. 2497 (1954) issued under the *Exchange Control Act B.E. 2485 (1942)*. These laws set out the principles of controlling, restricting, or prohibiting the execution of all exchange or other operations where foreign currency in whatever form is concerned.

Foreign exchange controls are issued under the act with following major objectives:

- (i) To centralize the foreign exchange of the country.
- (ii) To channel foreign exchange for public benefit.
- (iii) To monitor capital outflows.
- (iv) To stabilize the value of baht.

a. Foreign Currency Restriction

Foreign currencies can be brought into Thailand without any limitations. Any person receiving foreign currencies from abroad is required to sell such foreign currencies to an authorized financial institution, or to deposit them in a foreign currency account with an authorized financial institution within 360 days from receiving date. An exception is made for foreign embassies, international organizations and foreigners temporarily staying in Thailand not exceeding 3 months.

Foreign exchange purchase or hedging with authorized financial institutions is generally available where a genuine underlying current or capital transaction exists.

b. Local Currency Restriction

There is no restriction on the amount of baht that may be brought into the country. A person travelling to Thailand's bordering countries, including Viet Nam, is allowed to take out up to THB500,000 (USD15,000), and to other countries up to THB50,000 (USD1,500) without authorization.

c. Measures to Prevent Thai Baht Speculation

i. Measures to Limit Thai Baht Liquidity

Domestic financial institutions are limited to provide Thai baht liquidity to a non-resident (NR) in the case of payments undertaken without underlying transactions (so-called 'real demand principle'). The total outstanding balance provided by each financial institution shall not exceed THB300 million (approximately USD9.6 million) per group of NRs.

ii. Measure to Curb Capital Inflows

Without underlying transactions, domestic financial institutions are limited in borrowing or undertaking transactions comparable to Thai baht borrowing from NRs. The total outstanding balance executed by each financial institution shall not exceed THB100 million (USD3 million) per group of NRs.

iii. Measure on Non-Resident Baht Account and Non-Resident Baht Account for Securities Account

Foreign investors in the securities market are required to open a Non-Resident Baht Account (NRBA) and a Non Resident Baht Account for Securities (NRBS). NRBA and NRBS accounts are both limited to an end-of-day balance not exceeding THB300 million (approximately USD9.6 million) per non-resident, which include balances of all accounts opened by each non-resident across all domestic financial institutions in Thailand.

The typical securities-holding structure in omnibus accounts in the name of global custodians with custodian banks in Thailand and the corresponding funding through aggregate cash accounts may lead to challenges in complying with said regulations, e.g., also in case of large bond interest or redemption payments. Custodian banks encourage investors to work closely with them to avoid non-compliance with the regulations.

Domestic financial institutions are also not permitted to pay interests on accounts, with the exception of NRBA time or fixed deposits with maturities 6 months or longer.

iv. Measure on Non-Deliverable Forward

Domestic financial institutions are not allowed to undertake non-deliverable forward (NDF) transactions against Thai baht with non-residents.

P. Taxation Framework and Requirements

Residents and non-residents investing in the Thai market are charged withholding tax on dividends and fixed income as follows:

Table 2.7 Duties and Tax on Dividends and Fixed Income

Duties and Tax	
Withholding Tax (WHT)	
WHT - Equities	10% on dividend
WHT - Fixed Income	15% on interest
Capital Gains	0 - 15% subject to Double Tax Agreements (DTA)
Stamp Duty	No (Stamp duty is only applied to physical certificate of non-listed securities at a rate of THB 1 for every THB 1,000 of the trade counter-value [OTC].)
Other Taxes	Value Added Tax (VAT) is 7%
Source: Deutsche Bank AG Domestic Custody Services, Market Guide Thailand, December 2009.	

1. Withholding Tax

The tax liability of incomes from investments in debentures is classified into three categories: (1) interest income, (2) capital gains and (3) discount, or the difference between the redemption price and bid price, and bid price in the case of debentures that yield no interest but are sold below the redeemed value. The tax is determined by the type of income and the nature of the investor or income earner. Generally, payers withhold income tax upon payment at rates of 15% on natural persons, 1% on juristic persons, and 10% on foundations or associations. Payments made to banking institutions, securities or other semi-banking institutions are liable to a 3.3% specific business tax.

Investments in debenture of mutual funds are exempt from income tax on capital gains because mutual funds are juristic persons separate from fund management institutions. All benefits that mutual funds receive in interest, capital gains and discounts are exempt from tax computation. But unit-holders of mutual funds are liable to income tax applicable to natural or juristic persons, as the case may be, on dividends or profit sharing of the investment units in the same manner the tax liability of investment in equity instruments.

2. Specific Business Tax

Specific Business Tax (SBT) is collected from individuals, groups of persons who are not juristic persons, and any other juristic persons on incomes derived from engaging in the businesses of banking, finance and securities, credit foncier, life insurance, pawn brokerage, semi-commercial banking, and real estate. Banking, financial and securities institutions pay SBT on income of interests, discounts, fees, service fees, and gross profits-before-expenses from transactions in any bills or debentures, foreign exchange, drafts, or overseas remittance. The SBT on incomes relative to bonds is levied at 0.01%, to be remitted to government authorities.

3. Double Taxation Agreements

Double Taxation Agreements (DTAs) are treaties signed by Thailand and other countries which specify tax exemption on incomes derived from investments, whereby investors are only liable to income tax in one country to induce foreign investment. The DTA applies to persons who are residents of the Contracting States and applies to direct taxes, namely, personal income tax, corporate income tax, and petroleum income tax. Other indirect taxes such as value added tax, SBT, excise tax, etc., are not covered by a DTA. The DTA also prescribes a ceiling rate for tax collection, which the source country must not exceed.

4. Tax Exemption for Non-Resident Investors

Under Ministerial Notifications No. 249 B.E. 2548 (2005) and Royal Decree No. 429 B.E. 2548 (2005), individuals, juristic companies, or partnerships established under foreign law and not operating business in Thailand are exempted from income tax on the following assessable incomes:

- (a) Interests received from government agencies bonds.
- (b) The difference between redemption price and selling price of government agencies bonds issued and sold the first time at a price lower than the redemption price (discount).

(c) Benefits received from the transfer of government agencies bonds (capital gain).

However, withholding tax exemption on income and capital gains from government securities trading have been revoked effective 13 October 2010, in line with other capital control measures.³⁵ Nevertheless, the withdrawal of previous exemptions should principally not affect specific provisions in prevailing DTAs. Investors are encouraged to seek the advice of professional tax advisors with regards to their own specific tax situation.

5. Taxation Framework and Tax Requirements Summary

Table 2.8 Summary of Taxation Framework and Tax Requirements in Thailand

Type of Bonds	Resident Investors		Non-resident Investors	
	Interest Income	Capital Gains	Interest Income	Capital Gains
Government and Quasi-Government Bonds (including Securities and Futures Institutions)	Individual: 15% withholding tax (recipients can choose to include in calculating for personal income tax) Corporate: 1% withholding tax	Individual: 15% withholding tax (for zero-coupon instruments; if 15% is prepaid, capital gains is tax exempt) Corporate: Liable for corporate income tax	Individual: 15% withholding tax Corporate: 15%withholding tax	15% withholding tax Corporate : 15% withholding tax
Corporate Bonds	Individual: 15% withholding tax (recipients can choose to include in calculating for personal income tax) Corporate: Liable for corporate income tax.	Individual: 15% withholding tax except for zero-coupon bonds, and can choose not to include in the year-end income tax. Corporate: - No withholding tax - Exempt for Mutual Fund - Included in corporate income tax	Individual: 15% withholding tax Corporate: 15%withholding tax	15% withholding tax Corporate : 15% withholding tax
Supranational Bonds	Waived	Waived	Waived	Waived
Securitized Bonds	Individual and Corporate: 15% withholding tax upon debenture interest payment	N/A	Individual and Corporate: 15% withholding tax upon debenture interest payment	N/A

Source: Securities and Exchange Commission Thailand.

³⁵ PricewaterhouseCoopers Thailand. *Tax Flash Report 2010*. <http://www.pwc.com/th/en/tax-flash-2010/tax-flash-report-23-2010.jhtml>

III. Trading of Bonds and Trading Market Infrastructure

A. Trading of Bonds

Bond trading in Thailand can take the form of either over-the-counter (OTC) or exchange traded. Bonds are normally traded in a big lot and are less frequently traded compared to equities. As such, most bonds traded in the secondary market are traded through OTC by negotiation between buyer and seller. Most transactions take place over the telephone or via voice broker, and trading via the electronic trading platform, is rarely observed.

Box 3.1 Excerpt from Primary to Secondary Market Description by the International Monetary Fund

II. THE PRIMARY DEBT MARKET

F. Other Related Fixed Income Markets

Repo Market

43. The Thai money markets comprise the market for unsecured money, synthetic term money and repo. The principal feature of the money markets is the ample liquidity of the Thai banking sector. This obviates their need to actively use the money markets, particularly the term money market, to fund their activities, limiting activity in the markets. In addition, market contacts report that, due to the distortions introduced by the Specific Business Tax (SBT), where term money market trades are executed, these are generally effected through synthetic money market positions, i.e., through the foreign exchange (FX) forwards market.

However, apart from this factor, the principal concern expressed by market contacts related to the functioning of the repo markets, and the private repo market in particular.

44. Overall, the BOT plays a dominant role in the repo market. The repo market is actively used by the BOT to implement monetary policy—through its bilateral repo operations. In addition, the BOT operates the BOT repo market, effectively acting as a central counterparty for interbank repo. However, in 2006, the BOT announced its intention to close this market in order to promote the development of a private repo market.

45. A successful transition to a private repo market requires industry agreement on a number of technical factors including agreeing [on] a standard master agreement—a Global Master Repurchase Agreement (GMRA), appropriate collateral management functionality within the securities depository, regulatory agreement on collateral and margining rules and counterparty risk management. While the required enhancements to the Thailand Securities Depository Co., Ltd. (TSD) appear to have been implemented, market sources report that, despite BOT's best efforts, progress on resolving other technical issues remain seems to have stalled. This is impeding market participants' ability, in particular, to execute the GMRA with counterparties. In addition, there are a number of potential regulatory impediments which may restrict certain market participants' ability to participate on equal terms. (*24: For example, the insurance regulator has set a minimum haircut that must be applied to all repo transactions that an insurance company enters into. This may restrict their ability to compete on favorable terms.)

continued on next page

Box 3.1 continuation

Although several industry representatives expressed a desire that the MOF, BOT, and SEC take leadership in addressing these issues, BOT has requested that the Financial Market Association (known as ACI club) take on this role.

III. THE SECONDARY DEBT MARKET
B. Secondary Market Infrastructure

57. Secondary market activity takes place in both the OTC market and on-exchange. The on-exchange market—the BEX—is an electronic market targeted at small, retail transactions.

In the period Jan-July 2006, average trade size was of the order of B4 million with an average monthly trade value of B21 million. Liquidity is provided by authorized dealers—not necessarily the PDs, with clients hitting or lifting advertised bids or offers. They cannot submit their own quotes. In addition, the exchange provides an electronic platform—the Fixed Income and Related Securities Trading System (FIRSTS)—to the OTC market. This mimics the OTC trading functionality, providing both a platform for inter-dealer trading and for dealer-wholesale client trading. Again, clients are not permitted to post their own bids or quotes but can only absorb the liquidity offered through the platform; however, the technology does allow clients to send a “request for quotes” (RFQ) to multiple dealers at once and to conduct bilateral negotiations off-line. (*27: The time delay between information transmittal is reportedly one of the impediments to greater use of the system; however, BEX is planning a systems upgrade which should reduce the time lag from around 10 seconds to around 3 seconds.)

FIRSTS was officially launched by BEX on March 1, 2006. (*28: The system was developed by the TBMA, who subsequently sold the platform to BEX when it became the self-regulatory organization (SRO) for the market.)

In the period Mar-July 2006, [the] average trade size was B63 million, with an average monthly trade value of B20.6 billion. Overall, trading is concentrated in the OTC wholesale market (approx. 98 percent of trading), with most of that being conducted over the telephone rather than on the FIRST system (93 percent telephone relative to 5 percent through FIRSTS).

58. All trades in bonds registered by the TBMA must be reported to the TBMA within 30 minutes. The TBMA publishes trade reports for government securities upon receipt and twice daily for corporate bond trades.

Source: International Monetary Fund. 2009. “Secondary Market Infrastructure and Repo,” Thailand: Financial Sector Assessment Program—Technical Note—Fixed Income Markets April 2008.” IMF Country Report No. 09/151. <http://www.imf.org/external/pubs/ft/scr/2009/cr09151.pdf>

B. Trading Platforms

The Bond Electronic Exchange (BEX), a division of the Stock Exchange of Thailand (SET), was officially launched on 26 November 2003. BEX’s objective is to develop the secondary market for bond trading in Thailand. BEX’s main roles are as follows:

- (a) Support the development of Thailand’s secondary bond market
- (b) Expand bond activities to smaller investors
- (c) Properly educate non-institutional investors on additional investment instruments

To attract bond activities in both retail and wholesale markets, BEX has been granted approval from the SET’s committee to include both government issues and corporate issues in its exchange. BEX will also include Asian bonds in its trading platform.

There are two trading methods for retail investors on BEX:

- (i) Automatic Order Matching (AOM)
- (ii) Put Through (PT) for retail market when trading value crosses over 10,000 units (THB10 million)

The SET now operates bond trading on both the exchange platform (AOM) and the non-exchange platform (Fixed Income and Related Securities Trading System [FIRSTS]), which aims to serve fixed-income dealers and institutional investors. Institutional and large-scale investors trade via FIRSTS.

C. Bond Information Center

The Thai Bond Market Association (ThaiBMA) serves as the information center in collecting and distributing information on the bond market. The following Securities and Exchange Commission (SEC) regulations support the role of ThaiBMA as information center and SRO for the bond market:

1. All Public Offering and some Private Placement corporate bond issues must register with ThaiBMA. While there is no such regulation applied on government securities, in practice, all government bond issues are automatically registered with ThaiBMA.
2. All licensed dealers must report transactions in each bond to the ThaiBMA within 30 minutes of trade. The data is then disseminated on a real-time basis through the ThaiBMA website.³⁶

Figure 3.1 Screenshot of Intraday Trading Information

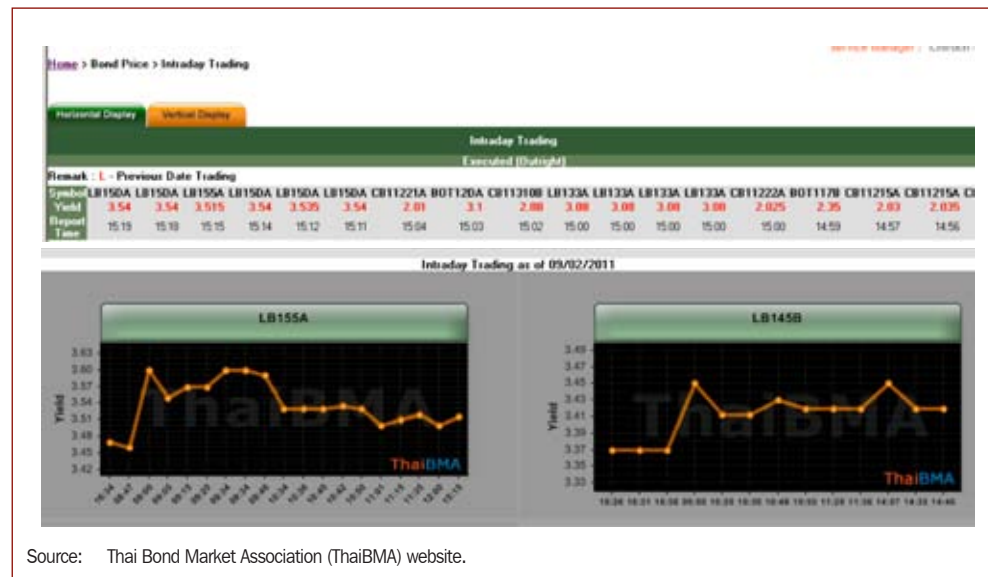

Currently, ThaiBMA categorizes reported data into three types to facilitate the analysis and follow up of the bond market, and provides a fair and valid reference to the data as follows:

- (1) Outright transaction: a one-shot transaction under no obligation agreed upon in advance, such as the sell-and-buy-back price; generally, it refers to T+4 transactions that are handed over within 4 business days.

³⁶ Footnote 3. <http://www.thaibma.or.th/aboutus/aboutus.html>

- (2) Financing transaction: under the repurchase agreement (repo) or sell-and-buy-back condition where bonds are treated as collateral.
- (3) Other transaction: any transaction other than the outright and financing transactions, such as transactions with prior agreements, transactions that are handed over after 4 business days, or transactions according to options or forward agreements, etc.

Transaction reports submitted to ThaiBMA are scrutinized by the Monitoring and Surveillance Department prior to compilation and dissemination to the general public, and for the mark-to-market process of bonds.

D. Government Bond Yield Curve and Bond Indices

ThaiBMA developed the Government Bond Yield Curve by using bidding yields quoted daily by primary dealers, which is published on the website on a daily basis. Additionally, ThaiBMA publishes reference yields of state-owned enterprise (SOE) bonds, Financial Institutions Development Fund (FIDF) bonds and Treasury bills. The yield curve information has been disseminated to the public on a daily basis since 1999. This yield curve can be found on the Thai BMA's website.

Figure 3.2 ThaiBMA Government Bond Yield Curve as of 17 June 2011

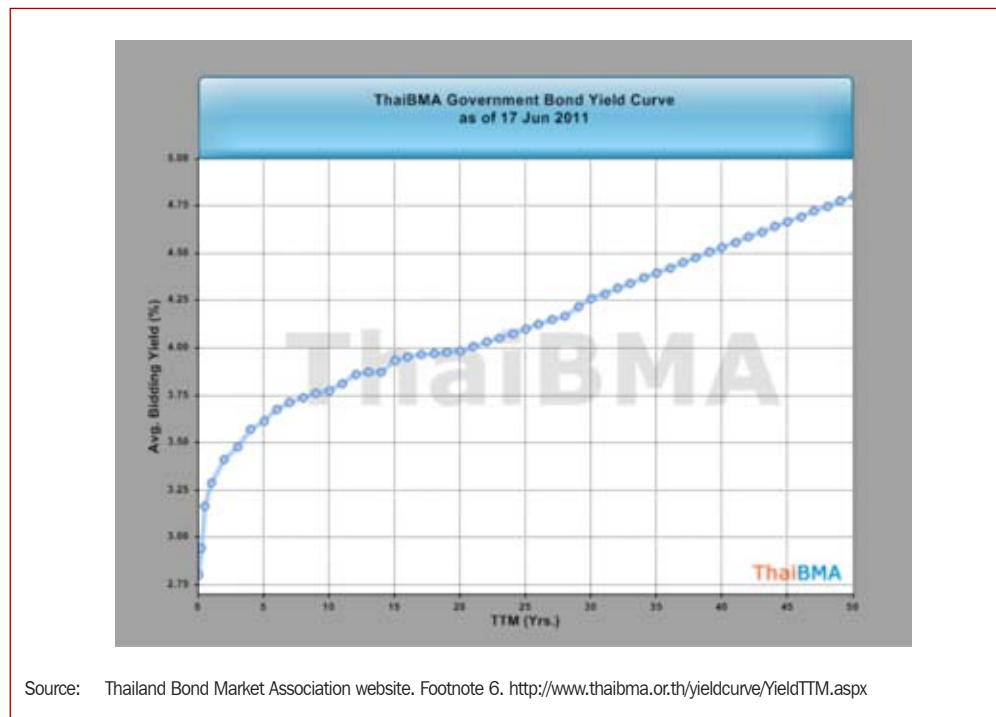

In addition to the yield curve, ThaiBMA also developed the ThaiBMA Index as a tool to track market performance. The ThaiBMA Index comprises the Total Government Bond Index, Corporate Bond Index, and the Categorized Index, is divided into several subgroups by maturity, e.g., 1–3 years, 3–7 years, 7–10 years, and over 10 years.

ThaiBMA bond indices are publicly available on a daily basis.

Figure 3.3 ThaiBMA Government Bond Index

Type	Clean Price	Chg (point)	Gross Price	Chg (point)	Total Return	Chg (point)	Yield	Average Duration	Conv
Government Bond Index	102.32	-0.04	104.03	-0.03	200.47	-0.06	3.78	5.59	55.73
Maturity Sub Group									
3M (1.1 x TTM (a. 3))	83.47	-0.02	84.50	-0.01	162.27	-0.01	3.00	1.89	4.01
6M (1.2 x TTM (a. 3))	106.92	-0.12	108.71	-0.12	206.90	-0.12	3.47	4.00	22.70
1Y (1.2 x TTM (a. 3))	121.90	-0.02	123.87	-0.01	256.57	-0.02	3.63	6.56	51.04
1.5Y (1.2 x TTM (a. 3))	144.24	+0.03	146.02	+0.01	280.45	+0.01	4.07	10.17	142.45
2Y (1.2 x TTM (a. 3))	94.17	-0.06	95.12	-0.06	181.35	-0.04	3.46	3.80	22.67
3M (1.1 x TTM (a. 3))	103.16	-0.04	104.42	-0.01	126.00	-0.01	3.77	3.74	24.34
Maturity Sub Group									
3M (1.1 x TTM (a. 3))	99.35	-0.02	100.49	-0.02	122.00	-0.01	3.14	1.77	4.42
6M (1.2 x TTM (a. 3))	107.22	-0.06	108.51	-0.12	126.32	-0.06	3.69	4.06	25.46
1Y (1.2 x TTM (a. 3))	112.17	-0.06	113.47	-0.12	137.00	-0.06	3.97	6.06	56.40
1.5Y (1.2 x TTM (a. 3))	110.01	-0.02	112.03	-0.02	132.25	-0.02	4.20	3.28	100.43
2Y (1.2 x TTM (a. 3))	102.96	-0.04	104.91	-0.10	126.30	-0.02	3.68	3.41	19.44
6M (1.2 x TTM (a. 3))	106.42	-0.02	107.86	-0.02	130.16	-0.02	4.20	5.00	44.59
Maturity Sub Group									
3M (1.1 x TTM (a. 3))	103.13	-0.02	104.32	-0.01	123.00	-0.01	3.24	1.85	4.01
6M (1.2 x TTM (a. 3))	109.12	-0.01	110.62	-0.04	133.16	-0.01	3.92	3.92	10.90
1Y (1.2 x TTM (a. 3))	100.67	-0.01	101.57	-0.01	126.07	-0.01	4.25	6.72	54.75

Source: Thai Bond Market Association (ThaiBMA) website.

E. Bond Futures

In 2010, the Thailand Futures Exchange (TFEX) launched its first interest rate-based derivatives product called “bond futures.” Recently, there are three groups of bond futures contracts in the market, which are short-term interest rate-based futures—3M BIBOR Futures and 6M THBFIX Futures—and long-term interest rate-based futures—5-year Government Bond Futures.

F. Repo Transactions

1. Repo transactions on corporate bonds are allowed. The eligible securities for repo transactions on bonds are mutually agreed between counterparties, which can come in the form of commercial papers, certificates of deposit, non-convertible debt, and convertible debt.
2. Any entities such as dealers, institutional investors and retail investors can participate in repo transactions. Any securities company authorized by the SEC can participate in repo transactions. There are no regulations in place, except on the following: 1) repo with non-resident is available for government bonds; 2) repo with retail investors is available only for government bonds.
3. For margin requirements for participants entering repo transactions, both lender and borrower have an obligation to monitor market movement, and are obligated to provide a margin if price movement is greater than a preset threshold, determined as follows:
 - a. Market Value = Gross Price % X Current Par X No. of Units
 - b. Required Securities Value = (Purchase Price + Accrued Interest)/(1- Initial margin)
 - c. Threshold = ± THB500,000
 - d. Market value < Required securities value
 - e. Margin exposure = Market value - Required securities value
 - f. Margin exposure > threshold => Call margin

IV. Possible Items for Future Improvements

A. Impediments to the Thai Bond Market

1. Limited of Investor Base

Corporate investors remain few. Therefore, transactions are within the cluster of a small number of major investors. At the same time, retail investors lack a good knowledge or understanding of the bond market. They are content with commercial bank deposits rather than with other kinds of investment. At present, as the government provides unlimited guarantee on deposits at commercial banks, many depositors choose a lower return for the security of their deposits. Meanwhile, the government has already endorsed the setting up of a Deposit Insurance Agency. As a consequence, there should be a shift of deposits away from small banks, and some of them should flow into the bond market.

2. Few Bond Issuances by the Private Sector

Currently, there are just over 100 private enterprises who issue bonds. These are few, compared to the number of companies listed on the Stock Exchange of Thailand. Another reason is that commercial banks try to offer loans at low interest rates and under attractive conditions to maintain their corporate customers of good credit standing. Therefore, these companies do not see the benefit of bond issuance in reducing costs.

B. Significant Factors

The following are the main inhibiting obstacles in the development of the corporate bond market. The scale of 1 to 5 indicates the least significant factor to the most significant factor, respectively.

Table 4.1 Factors Inhibiting the Development of the Corporate Bond Market in Thailand

Factors	Scale
Availability of easy and cheap bank loans/competition from banks against the corporate bond market	5
Buy and hold strategy adopted by investors	5
Lack of efficient market making system	3
Differential treatment in favor of government bonds / loans (such as differential tax treatment in favor of government bonds / loans.)	3
Unstable political and macroeconomic environment	3
Investors' conservative approach to corporate bond market	3
Lack of retail participation	3
Riskiness of the instrument and risk aversion of investors	3
Lack of hedging instruments against market risks	2
Crowding out by large governmental borrowings	2
Lack of liquidity attributes in secondary market and opacity of secondary market	2
Lack of efficient trading, clearing and settlement mechanisms	2
Inadequate price transparency (such as inadequate reporting requirements in OTC bond markets or non-existence of price vendors to support the valuation process in the corporate bond markets)	2
Inadequate savings level for investment in corporate bond market	1
Inefficient and expensive primary market (High issuance costs, costly disclosure requirements, etc. in issuance process)	1
Protracted pre-launch reviewing period and lengthy approval time.	1
Insufficient information disclosure by issuers	1
Lack of advanced, economical and less burdensome securities offering methods for institutional investors (traditional private placements, institutional offerings, integrated disclosure, self-registration and other hybrid regimes)	1
Lack of a benchmark yield curve from government bond issuance in pricing the corporate bond issues	1

Source: Securities and Exchange Commission Thailand.

V. Description of the Securities Settlement System

Please see the International Monetary Fund's detailed assessment of the Thailand Securities Depository by the Committee on Payment and Settlement Systems (CPSS) and International Organization of Securities Commissions (IOSCO).³⁷

A. Securities Settlement Infrastructure

As both depository and registrar, the Bank of Thailand (BOT) is responsible for the settlement of government bonds. In 2001, BOT's real-time gross settlement (RTGS) system—BAHTNET—was restructured to incorporate delivery-versus-payment (DVP) facilities on all government securities.

Most corporate bonds are cleared and settled at the Stock Exchange of Thailand (SET) subsidiary, the Thailand Securities Depository (TSD).

Debt securities clearing and settlement services provided by TSD meet the international standard according to the Group of Thirty (G-30) recommendations. DVP and Receipt versus Payment (RVP) are implemented on an RTGS basis for the clearing and settlement system in Thailand. The settlement and delivery dates are on the second day after the trade date (T+2), the procedures of which are as follows:

- (i) The seller and buyer send information regarding the delivery and receipt of securities for each transaction either via the TSD Web Service or the SWIFT Network.
- (ii) TSD verifies the information before matching. If the securities balance of the seller in the depository system is sufficient, the system will proceed with TSD sending an order to the BOT's BAHTNET system to transfer funds to the buyer's account. In case the securities balance is not sufficient, the order will be held in queue until the end of the day.

³⁷ International Monetary Fund. 2009. *Thailand: Financial Sector Assessment Program—Detailed Assessment of Observance of Thailand Securities Depository (TSD) of the CPSS/IOSCO Recommendations for Securities Settlement Systems*. IMF Country Report No. 09/150. <http://www.imf.org/external/pubs/ft/scr/2009/cr09150.pdf>

- (iii) The BAHTNET system will go through the balance of the buyer to ensure that there is a sufficient amount of funds for transferring. In case of any problems, the BOT will inform TSD immediately.
- (iv) If there is a sufficient amount of funds, the BAHTNET system will transfer the funds from the buyer's account to the seller's account and inform TSD of the transaction accordingly.
- (v) TSD sends confirmation to the buyer and seller at the end of the day.

1. The Thailand Securities Depository and Book-Entry System for Debt Instruments

TSD provides an in-house development called Post-Trade Integration (PTI) system as the book-entry system to TSD's members. The functions on the PTI system include custody, clearing and settlement, and submission of list of bondholders to the BOT. The system aims to provide the settlement mechanism for both Deliver/Receive Versus Payment (DVP/RVP) and Deliver Free of Payment (DP) and Receive Free of Payment (RF). TSD's members can submit settlement orders via SWIFT³⁸ messages or the PTI system.

The SET has successfully implemented PTI. PTI is designed based on new technology that supports straight-through processing (STP), connecting it with external systems automatically via global message standards. In addition, it integrates all financial instruments, such as equity, corporate and government bonds into one system. The introduction of PTI helped improve the efficiency and effectiveness of business operation and risk management.

Having gone live in October 2007, PTI replaces legacy systems that supported after-trade services from securities clearing and settlement to securities depository, and from securities registration to risk management of the clearing house. Besides improving performance of post-trade systems, PTI enables a variety of value-added services such as real-time linkage with BOT, equities securities borrowing and lending (SBL), and the most recent service introduced by TSD, the Repurchase Agreement (REPO). PTI not only supports but is also central to TSD. PTI's focuses are performance, cost reduction and automated processes.

Built on modern technology and global standard, PTI's capabilities are enhanced in many aspects, including:

- (i) Ease of use and setup of new user interfaces with design based on web-based technology, and utilizes CITRIX to both provide fast response and reduce bandwidth cost.
- (ii) Message specification is based on ISO 15022 standard.
- (iii) Real-time linkage with BOT's BAHTNET system and SWIFTNet to reduce risks, attaining the highest level of efficiency and meeting international standards of clearing and settlement such as DVP/RVP transactions via RTGS.
- (iv) Automated business processes with transaction, which reduce errors from human intervention.
- (v) Online business reports with ability to export them in standard format.

³⁸ SWIFT stands for Society for Worldwide Interbank Financial Telecommunication.

Table 5.1 Information on Post-Trade Integrated (as of 31 January 2008)

PTI members		96	
Securities using registration services		577	
Settlement value (average per day)			
	Equity	3,302	MB
	Government bond	196,509	MB
Depository value (scripless)			
	Equity	4,030,748	MB
	Government bond	2,540,153	MB
Registered capital amount of registrar members		1,995,157	MB
Source: ??????.			

2. Delivery Versus Payment and Real-Time Gross Settlement Mechanism

TSD applies DVP and RTGS only with gross settlement. DVP shall be employed between TSD and TSD's members. RTGS shall be implemented between TSD and the BOT. The process involves:

- (a) Receiving orders from the PTI system and automatically check the availability of such securities in the specified depository account provided by the members.
- (b) Holding such securities until the system acknowledged the payment confirmation.
- (c) Submitting payment requests to BOT through RTGS.
- (d) BOT clearing the money by submitting the payment confirmation back to PTI system. The details shall specify that BOT has deducted money from the purchaser bank account and deposited it into the seller bank account.
- (e) PTI shall transfer held securities to the purchaser's depository account as specified.

3. Post-Trade Matching Mechanism

PTI only provides the matching mechanism for over-the-counter (OTC) transactions as gross-gross settlement. Thus, TSD sets the criteria the post-trade matching mechanism for gross-gross settlement by using the following six fields:

- (i) Settlement date
- (ii) International Securities Identification Number (ISIN) code
- (iii) Amount of securities
- (iv) Sender's depository account
- (v) Receiver's depository account
- (vi) Amount of payment

However, for Delivery/Receive Free, TSD will use only five fields for the matching mechanism. The details are as follows:

- (i) Settlement date
- (ii) ISIN code
- (iii) Amount of securities
- (iv) Sender's depository account
- (v) Receiver's depository account

4. Execution Matching Mechanism

Execution matching is employed for trades on both the OTC market and the exchange. In principle, for net settlement of trades occurring on the exchange, TSD receives the matching information directly from the trading system of the exchange. For gross settlement occurring for trades originating in the OTC market, TSD utilizes PTI as the execution matching mechanism.

5. Settlement Scheme for Corporate Bonds, Government Bonds and Other Debt Securities

- (i) Gross-Gross for the OTC market
- (ii) Net-Net for the exchange

6. Settlement Cycle for Corporate Bonds and Government Bonds

- a. For the OTC market, the settlement cycle can be negotiated between counterparties and typically ranges from T+1 to T+3, depending on the involvement of foreign investors with time zone considerations.
- b. For the exchange, it is T+2.

B. Bond Settlement Infrastructure Diagram (Thailand)

Figure 5.1 Thai Bond Infrastructure Diagram

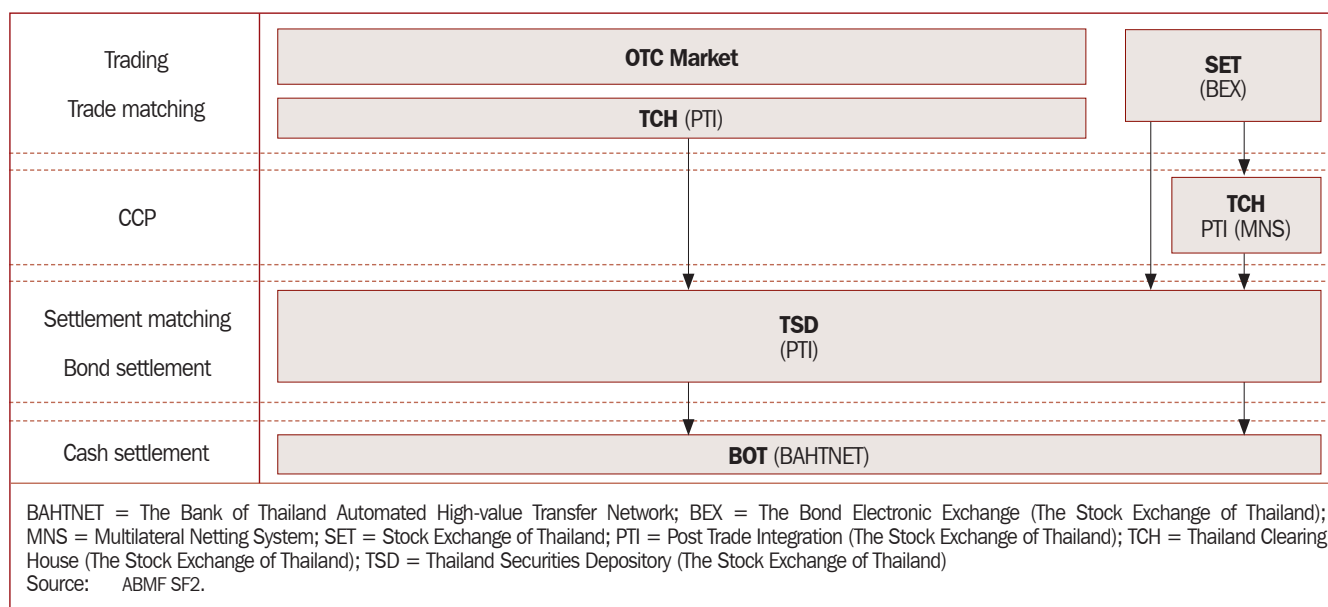

C. Brief History of the Development of the Securities Settlement Infrastructure

Prior to the year 2006, clearing and settlement was executed at the BOT both in physical and dematerialized securities. In 2006, TSD migrated the clearing and settlement of dematerialized securities (all types of debt instruments) into the PTI system. However, the BOT remains responsible for the clearing and settlement of physical securities. In addition, cash clearing for transaction in both dematerialized and physical securities must be performed by the BOT. This is the current concept for clearing and settlement in Thailand.

The Central Counterparty (CCP) function for securities was transferred from the TSD to Thailand ClearingHouse Co., Ltd. (TCH), which acts as CCP for derivatives since February 2010. TCH, as a legal entity of a clearing house for both equities and bonds for trades on the SET and via OTC trading.³⁹

D. Business Process Flowchart in the Thailand Over-the-Counter/Delivery Versus Payment Bond Market

Figure 5.2 Business Process Flowchart in the Thailand Over-the-Counter/Delivery Versus Payment Bond Market

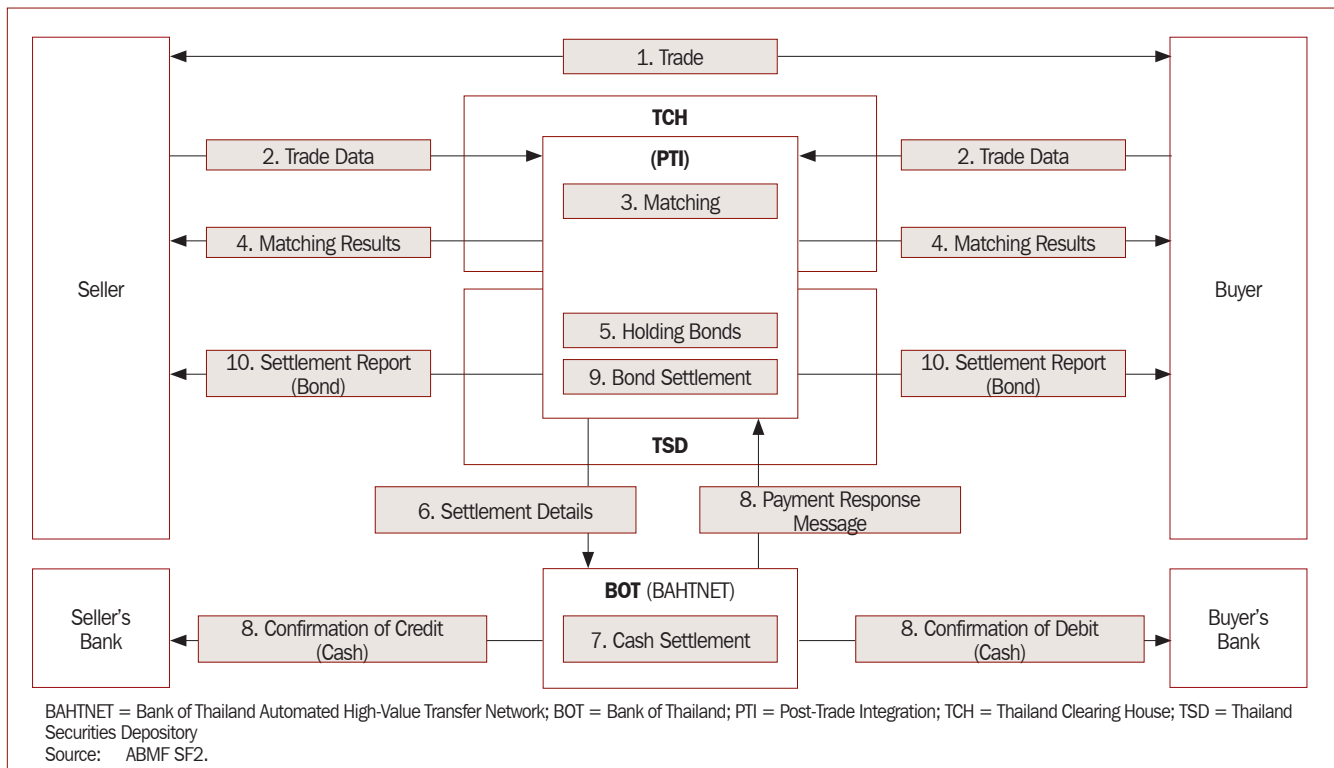

1. Seller and buyer trade via OTC market.
2. Seller and buyer send the transaction details to TCH via PTI System.
3. TCH matches trade data from seller and buyer.
4. TCH sends matching results to seller and buyer via PTI System.
5. TCH sends settlement details to TSD. Then, TSD checks availability and blocks securities in member account.
6. TSD sends cash settlement details to BOT.
7. BOT executes cash settlement.
8. BOT sends cash settlement confirmation to seller, buyer and TSD.
9. TSD releases blocked and executes securities delivery.
10. TSD sends settlement reports to seller, buyer and TCH via PTI System.

E. Thailand Bond Transaction Flow for Foreign Investors

³⁹ Thailand Clearing House Co., Ltd. <http://www.thaiclearing.com/en/PublicRelation/20100211-12.pdf>

Figure 5.3 Thailand Bond Transaction Flow for Foreign Investors

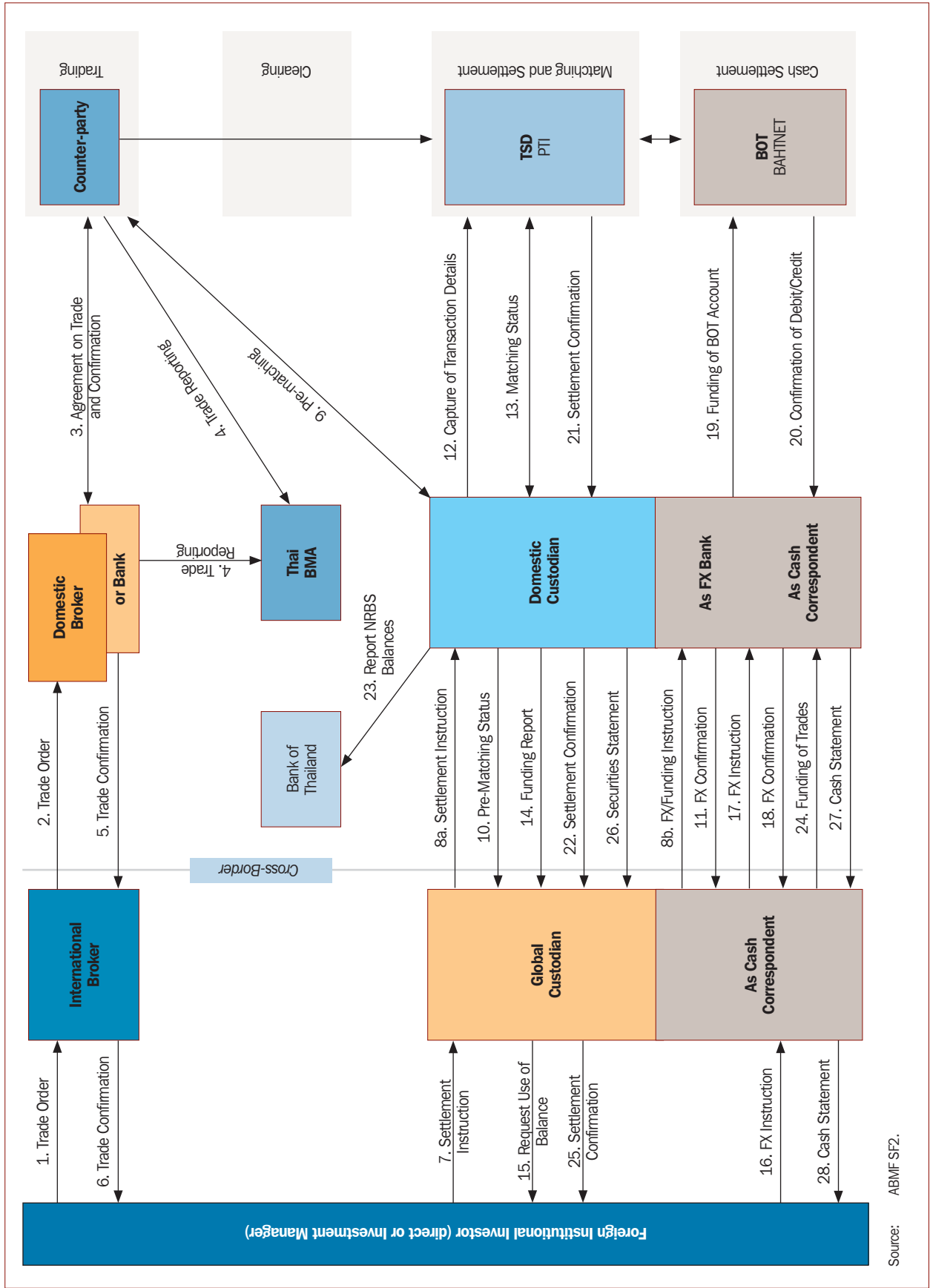

F. Role of the Thailand Clearing House

Immediately after a trading transaction is matched, the TCH as CCP, becomes a buyer to every selling member and a seller to every buying member. As a clearinghouse for all securities and derivatives traded on the SET, BEX, the Market for Alternative Investment (MAI) and the Thailand Futures Exchange (TFEX), TCH's most important role is to serve as the CCP to all trading activities on those exchanges. Thus, TCH will guarantee clearing and settlement for a concerned party; it does not matter whether any counterparty breaks their commitment. This is a crucial mechanism to lessen counterparty risk.

Immediately after a trading transaction is matched and exchanges have been confirmed at the matching transactions by their members, the TCH, as the direct CCP, becomes a buyer to every selling member and a seller to every buying member. Therefore, a member who has bought or sold the securities has an obligation not to the party on the other side of the transaction, but to the clearinghouse, just as the clearinghouse has an obligation to the member. This is called a novation process.

G. Definition of Clearing, Settlement and Assessment

Securities clearing and settlement mean the payment, acceptance of payment, delivery, and taking delivery of, securities.⁴⁰ An extract from Table 1 of the “Detailed Assessment of Observance of Thailand Securities Depository (TSD) of the Committee of Payment and Settlement Systems (CPSS)-International Organization of Securities Commission (IOSCO) Recommendations for Securities Settlement Systems (RSSS)” enumerates details on securities clearing, settlement, and assessment.⁴¹

1. Legal Basis of the Clearing and Settlement

The securities clearing and settlement activities in Thailand are governed and regulated by specifically issued laws and regulations and by provisions in other legislations and regulations. The main laws and regulations are:

- a. The *Civil and Commercial Code* (e.g., provisions governing juristic acts, obligations, contracts);
- b. The *Securities and Exchange Act B.E. 2535 (1992)* (SEA) (Sections 50–55, 199, 224–228);
- c. The *Public Limited Company Act B.E. 2535 (1992)*;
- d. Notifications, rules, and regulations issued by the SET and TSD;
- e. The agreement between members and TSD as a central securities depository (CSD) and a clearinghouse;
- f. *BAHTNET Rules and Regulations B.E. 2549 (2006)*; and
- g. The *Bankruptcy Act B.E. 2483 (1940)*.

2. Enforceability of Transactions

The contractual arrangements between TSD and its participants are fully enforceable under the *Civil and Commercial Code*. In particular, each participant signs a contract

⁴⁰ Thailand Clearing House. Thailand Clearing House Rules and Regulations. <http://www.thaiclearing.com/en/equity/rules/TCHregulationChapter200.pdf>

⁴¹ Footnote 53.

with TSD, which binds the participant to TSD regulations. TSD regulations can be enforced through legal action.

3. Customer Assets Protection

The law and regulation require a clear segregation and application of customers' assets from those of intermediaries. At the level of the CSD, an intermediary is obliged to separate between its securities holdings and customers' holdings. TSD is also required to separate its own securities holdings and the assets of its participants. In addition, entities acting as custodians such as banks, investment firms and other financial intermediaries are legally obliged to have an internal accounting system that allows the identification of the holdings of their customers at any time.

4. Immobilization and Dematerialization of Securities

In accordance with Sec. 225 to Sec. 228 of the SEA, immobilization in the TSD system has been arranged through the transfer of securities by book entry. The transfer of securities by book entry shall be deemed to be the delivery of securities, which constitutes the legal basis for the validity of securities transfer under Sec. 199 and Sec. 51 of the SEA. Moreover, securities transferred into the name of TSD shall be presumed to be securities held by TSD on behalf of its members or of any customers of its members. However, there is no explicit legislation for the dematerialization of securities.

5. Netting Arrangements

TSD assumes the role of a CCP for a multilateral netting procedure that takes place before the settlement is executed. This netting arrangement is enforceable under Sec. 341 to Sec. 348 of the *Civil and Commercial Code*, and Sec. 102 of the *Bankruptcy Act B.E. 2483 (1940)*.

However, since Sec. 102 of the *Bankruptcy Act* allows netting of obligations only if the cause of indebtedness is incurred before the date of the receivership order, TSD may not net its obligations against the obligations of the insolvent participant which arise on that date.

6. Securities Lending Arrangements

Securities lending and collateralization arrangements are based on the outright transfer of securities. The SEC rule requires the transfer of the legal title in securities borrowed from the lender to the borrower, and the legal title in collateral is transferred from the borrower to the lender.

7. Finality of Settlement

TSD rule clearly states the timing of finality and the way finality is achieved. The transfer of funds is enforced through BOT regulation. Furthermore, there is no explicit legal protection for settlement finality, which can be challenged by a court decision. In accordance with Sec. 115 of the *Bankruptcy Act*, the court is empowered to reverse the debtor's transfer of assets during the 3 months prior to an application to adjudicate him as bankrupt, and thereafter if the court finds that the debtor transfers such assets with the intention to give undue preference to a creditor. Thus, if the court orders the receivership of a clearing house member or a settlement bank, the court may cancel the transfer of funds and securities made during that period, if the official receiver is able to prove that the transfer has been made by the debtor with the intention to cause other creditors a disadvantage.

8. Delivery Versus Payment

TSD rule clearly states that all securities transactions must be settled on a DVP basis.

9. Challenges by a Court

No court case has yet occurred.

10. Enforceability of Rules and Regulations in the Event of Bankruptcy

There is no explicit legal protection of netting procedures as well as the settlement finality when insolvency is involved. Consequently, it cannot be ruled out that transactions settled in TSD will be protected against a court decision in the event a participant becomes insolvent.

11. Cross-Border Participation

There is no cross-border participation in TSD.

12. Conflict of Law Issues

Conflict of law issues is not applicable. An assessment on a scale of 1 to 12 shows “Broadly observed.” It is recommended to implement adequate legal measures that ensure the netting arrangement is legally protected even in the event of the insolvency of a participant.

H. Challenges and Future Direction

The contractual arrangements between TSD and its participants are fully enforceable under the *Civil and Commercial Code*. Netting arrangements can be challenged in the event of bankruptcy.⁴² Explicit legislation for the dematerialization of securities should also be considered going forward.

⁴² Footnote 53, Table 2.

VI. Cost and Charging Methods

A. Average Issuing and Trading Costs for Corporate Bonds and Commercial Papers

Some of the average issuing and trading cost components are illustrated in this chapter.

1. Transfer Fees

The Thailand Securities Depository (TSD) or the bank calculates and collects a transfer fee on a transaction basis.

Table 6.1 Transfer Fees for Government Bonds and Other Securities

Menu	Fee
a. Transfer fee for all government bond transfers that are not a personal asset transfer, inheritance transfer, or any transfers according to court order or the transfer of securities between securities accounts of the same owner.	THB35
b. Other securities transfer that are not categorized in (a)	THB10

Source: Thailand Securities Depository Co., Ltd.

2. Registration and Conversion Fees

TSD charges a registration fee of B20 for conversion of local shares to foreign shares and vice versa. Asset management companies charge a registration fee of THB10 per application for open-ended unit trusts for registration of name change.

3. Underwriting Fee

The underwriting fee depends upon the negotiations.

4. Brokerage Fees

Securities brokers who are SET's members charge brokerage fee or commission on buying or selling of securities at the following rates plus 7% of value-added tax (VAT).

- (i) For shares, warrants on shares, Transferable Subscription Right (TSR), Derivative Warrants (DW), Non-Voting Depository Receipts (NVDR), or unit trust for Thai Trust Fund (TTF):

Table 6.2 Brokerage/Commission Fees on Securities Transactions

Trading Types	Brokerage/Commission Fee (% of trading value)
Internet Trading	0.15%
Non-Internet Trading	0.25%

Source: Deutsche Bank AG Domestic Custody Services, Market Guide Thailand, December 2009.

- (ii) For unit trusts, or warrants on unit trusts, brokerage or commission fees are at the rate of not less than 0.10% of trading value.
- (iii) For unit trusts of a fixed-income fund, warrants on such unit trusts, or debt instruments, the brokerage or commission fee is negotiable.
- (iv) Beginning 1 January 2010, brokerage fees as detailed in Table 6.2 were applied. However, as part of the Stock Exchange of Thailand (SET)'s plan to fully liberalize securities business in Thailand by 2012, the brokerage fee is freely negotiable starting 1 January 2012.

B. Average Ongoing Costs for Corporate Bonds and Commercial Papers

1. Maintenance Fee at the Thailand Securities Depository

TSD collects maintenance fee on the basis of the remaining securities in the depository account on a monthly basis. Since TSD does not allow individual investors to open a depository account with TSD and does not recognize investors individually, TSD charges a fee to participant members who open securities accounts for their clients directly. The fees are shown as in the following.

Table 6.3 Maintaining of Securities Depository Account Fee

Menu	Fee per THB1 million of Value of Investment	Securities depository period by calculating the outstanding value of securities
a. Debentures /convertible debentures, short-term bonds, warrants, and other similar securities	THB1 monthly	Par Value
b. Bond, Treasury bills or other types of government debt instruments in depository account. - For 100% tax-exempted foundations and financial institutions whose government bonds are legal liquidity reserve.	THB0.25 monthly	Par Value

Source: Thailand Securities Depository Co., Ltd.

2. Interest Payment and Redemption Fee at the Thailand Securities Depository

- a. **Interest Payment.** TSD collects a fee for compilation of the bondholders' list on record date at the rate of B5 per transaction, with a minimum fee of THB500 per security.

- b. **Redemption Fee.** TSD collects a fee for compilation of the bondholders' list on record date at the rate of B5 per transaction, with a minimum fee of B500 per security. TSD also collects a withdrawal fee from TSD's members for withdrawing and terminating the securities from the book-entry system at the rate B65 per one depository account.

Details about fees for registration, transfer or registrar fee, as well as for deposit and withdrawal are available on the TSD website.⁴³

⁴³ Thailand Securities Depository. <http://www.tsd.co.th/en/info/fee1.html#Deposit>

VII. Market Size and Statistics

A. Nature and Size of the Thai Bond Market

1. The size of the market for debt instruments in terms of nominal or notional principal amounts outstanding and gross market values traded for 2009 are shown in Table 7.1.

Table 7.1 Size of the Market for Debt Instruments, 2009

Debt Instruments	Nominal/Notional Amount Outstanding (USD million)	Gross Market Value Traded Per Annum ((USD million)	
		Over the Counter	Exchange
Bonds	176,564.49	447,416.87	N/A
Government bonds	144,287.10	442,249.60	N/A
Corporate bonds	32,277.39	5,167.27	N/A
Commercial papers	2,298.00	1,512.11	N/A

Source: The Thai Bond Market Association.

2. Data for Corporate Bonds Issues by Type of Issue

Table 7.2 Data for Corporate Bond by Type of Issue (USD million)

Sector	2005		2006		2007		2008		2009	
	No. of Issues	Amount	No. of Issues	Amount	No. of Issues	Amount	No. of Issues	Amount	No. of Issues	Amount
Public Issues	67	37,168	84	39,558	71	39,009	93	28,477	29	11,026
Private Placements	31	4,279	12	5,093	12	763	37	2,708	30	1,805

Source: The Thai Bond Market Association.

3. Total Corporate Bond Trades in the Secondary Market

Table 7.3 Total Corporate Bond Trades in the Secondary Market, 2005–2009

Year	Exchange Traded		Over-the-Counter Trades	
	No of Trades	Traded Value (USD million)	No of Trades	Traded Value (USD million)
2005	N/A	N/A	N/A	2,390
2006	8,535	8	N/A	2,848
2007	8,849	9	N/A	4,158
2008	6,828	7	N/A	3,567
2009	4,585	5	N/A	5,167

Source: Thai Bond Market Association.

4. Size of the Market for Each Type of Bonds

Table 7.4 Size of the Market per Type of Bonds, 2009

Type of Bond	Amount (USD million)	
	Public Issue	Private Placement
Plain Vanilla Bond ^a	11,713.97	2,487.38
Floating-Rate Bond	61.54	172.04
Fixed-Rate Bond	11,652.43	2,315.34
Structured Bond	62.37	N/A
Convertible Bond	N/A	N/A
Other Types of Bonds	N/A	12.92

^a Plain vanilla bond = floating-rate bond + fixed-rate bond
Source: Thai Bond Market Association.

5. Main Buyers in the Corporate Bond Market

Table 7.5 Main Buyers in the Corporate Bond Market

Entity	%
Mutual Funds	7.9%
Banks/Financial Institutions	6.2%
Corporate Entities	6.4%
Insurance Companies	8.6%
Pension Funds	14.8%
Retail Investors	44.7%
Others (Government sector, foundation, co-operatives, temples, etc.)	11.4%

Source: Thai Bond Market Association.

6. Market Size by Local Currency

Table 7.6 Size of Thailand Financial Market, 2002-2010

Economic Indicator	2002	2003	2004	2005	2006	2007	2008	2009	2010
Bank Loans -- THB Billion *	4,602.70	4,701.50	5,081.35	5,488.43	5,706.75	6,221.76	7,368.65	7,675.57	8,767.56 (Nov)
Equities (SET mkt. cap) -- THB Billion **	1,986.24	4,789.86	4,521.89	5,105.11	5,078.70	6,636.07	3,568.22	5,873.10	8,334.68
Domestic Bond (at par) -- THB Billion ***	2,300.00	2,518.00	2,740.38	3,366.84	4,085.26	4,885.76	5,080.05	6,114.49	6,879.48

Source: * Bank of Thailand <http://www2.bot.or.th/statistics/BOTWEBSTAT.aspx?reportID=272&language=TH>
 ** SET http://www.set.or.th/th/market/market_statistics.html
 *** ThaiBMA Monthly Report >> Thai Bond Summary >> Part1 (include non-registered bonds)

Table 7.7 Thailand Bond Market Association Outright Trading and Outstanding Value, 2009–2010 (THB million)

Type	2009		2010		% Change	
	Outright Trading	Outstanding	Outright Trading	Outstanding	Trading	Outstanding
Government Bond	1,484,396.65	2,130,820.44	1,754,405.00	2,523,158.12	↑ 18%	↑ 18%
State Own Enterprise	78,988.31	532,052.97	43,230.05	501,776.88	↓ -45%	↓ -6%
- Guaranteed	59,435.16	372,182.87	35,096.19	341,560.40	↓ -41%	↓ -8%
- Non-guaranteed	19,553.15	159,870.10	8,133.86	160,216.48	↓ -58%	↑ 0.2%
T-Bills	1,288,820.61	206,540.00	807,037.43	71,710.00	↓ -37%	↓ -65%
State Agency	11,520,110.58	1,819,657.66	13,815,524.92	2,411,731.66	↑ 20%	↑ 33%
Corporate	167,927.46	1,123,638.02	178,168.18	1,189,304.60	↑ 6%	↑ 6%
- Long-term	118,786.00	1,048,956.97	127,568.92	1,103,640.44	↑ 7%	↑ 5%
- Short-term (Commercial Paper)	49,141.46	74,681.05	50,599.26	85,664.16	↑ 3%	↑ 15%
Foreign Bond	4,485.19	55,962.00	9,322.95	57,962.00	↑ 108%	↑ 4%
Total Value	14,544,728.80	5,868,671.09	16,607,688.53	6,755,643.26	↑ 14%	↑ 15%
- Monthly Average	1,212,060.73		1,383,974.04		↑ 14%	
- No. of trading days	243		242		↓ -0.4%	
- Daily Average	59,854.85		68,626.81		↑ 15%	
No. of Outright Transaction	94,947		104,532		↑ 10.1%	
- Monthly Average	7,912		8,711		↑ 10.1%	
- Daily Average	391		432		↑ 11%	
Dealer Participation	38		35		↓ -8%	

Unit : THB Million
 Source : ThaiBMA

B. Size of Local Currency Bond Market

Table 7.8 Size of Local Currency Bond Market, Local Sources (USD billion)

Date	Govt (USD billions)	Corp (USD billions)	Total (USD billions)
Mar-95	10.44	0.69	11.13
Jun-95	10.61	0.65	11.26
Sep-95	10.99	0.57	11.56
Dec-95	11.54	0.85	12.39
Mar-96	11.64	4.80	16.44
Jun-96	12.11	4.72	16.83
Sep-96	12.12	5.80	17.92
Dec-96	13.14	5.82	18.95
Mar-97	15.51	5.49	20.99

continued on next page

Table 7.8 continuation

Date	Govt (USD billions)	Corp (USD billions)	Total (USD billions)
Jun-97	15.92	5.81	21.72
Sep-97	9.80	3.88	13.68
Dec-97	7.64	3.01	10.65
Mar-98	9.98	3.45	13.44
Jun-98	13.46	2.94	16.40
Sep-98	14.86	3.18	18.04
Dec-98	20.33	4.12	24.45
Mar-99	23.28	3.94	27.21
Jun-99	24.74	4.17	28.91
Sep-99	23.42	3.95	27.37
Dec-99	26.57	4.96	31.53
Mar-00	26.51	5.14	31.65
Jun-00	26.53	5.23	31.76
Sep-00	26.64	5.07	31.72
Dec-00	25.89	5.16	31.05
Mar-01	26.64	4.78	31.42
Jun-01	27.19	5.21	32.4
Sep-01	29.14	5.64	34.78
Dec-01	30.12	5.69	35.81
Mar-02	32.04	5.56	37.60
Jun-02	33.92	6.12	40.04
Sep-02	39.63	5.76	45.39
Dec-02	40.41	6.50	46.92
Mar-03	40.68	6.45	47.13
Jun-03	41.98	6.78	48.76
Sep-03	46.74	7.79	54.52
Dec-03	46.50	11.55	58.05
Mar-04	48.04	11.43	59.47
Jun-04	47.46	11.09	58.55
Sep-04	50.89	10.82	61.71
Dec-04	54.43	12.22	66.65
Mar-05	56.90	12.11	69.00
Jun-05	57.58	12.55	70.13
Sep-05	62.21	13.06	75.27
Dec-05	64.93	14.06	78.99
Mar-06	72.43	15.69	88.12
Jun-06	75.66	17.90	93.56
Sep-06	79.54	20.21	99.75
Dec-06	87.00	24.52	111.52
Mar-07	95.27	23.89	119.16
Jun-07	98.57	26.75	125.32
Sep-07	103.48	27.22	130.70
Dec-07	111.48	27.72	139.19
Mar-08	126.91	29.30	156.21
Jun-08	121.23	29.09	150.32
Sep-08	119.11	27.78	146.88
Dec-08	112.11	28.83	140.94
Mar-09	118.64	28.71	147.35
Jun-09	125.66	33.45	159.11

continued on next page

Table 7.8 continuation

Date	Govt (USD billions)	Corp (USD billions)	Total (USD billions)
Sep-09	136.40	35.76	172.17
Dec-09	141.20	35.66	176.86
Mar-10	153.52	37.52	191.03
Jun-10	159.55	38.26	197.81
Sep-10	176.27	40.42	216.69
Dec-10	182.94	41.70	224.63
Mar-11	180.87	44.16	225.03
Jun-11	177.88	44.05	221.93

Source: AsianBondsOnline. http://asianbondsonline.adb.org/thailand/data/bondmarket.php?code=LCY_in_USD_Local

C. Size of Local Currency Bond Market in Percentage of Gross Domestic Product

Table 7.9 Size of Local Currency Bond Market in Percentage of Gross Domestic Product, Local Sources

Date	Govt (in % GDP)	Corp (in % GDP)	Total (in % GDP)	Govt (USD billions)	Corp (USD billions)	Total (USD billions)
Mar-95	6.8	0.4	7.3	10.44	0.69	11.13
Jun-95	6.7	0.4	7.1	10.61	0.65	11.26
Sep-95	6.8	0.4	7.1	10.99	0.57	11.56
Dec-95	6.9	0.5	7.5	11.54	0.85	12.39
Mar-96	6.9	2.8	9.7	11.64	4.80	16.44
Jun-96	7.0	2.7	9.7	12.11	4.72	16.83
Sep-96	6.8	3.3	10.1	12.12	5.80	17.92
Dec-96	7.3	3.2	10.5	13.14	5.82	18.95
Mar-97	8.7	3.1	11.7	15.51	5.49	20.99
Jun-97	8.4	3.1	11.5	15.92	5.81	21.72
Sep-97	7.5	3.0	10.5	9.80	3.88	13.68
Dec-97	7.6	3.0	10.6	7.64	3.01	10.65
Mar-98	8.1	2.8	10.9	9.98	3.45	13.44
Jun-98	12.0	2.6	14.6	13.46	2.94	16.40
Sep-98	12.5	2.7	15.2	14.86	3.18	18.04
Dec-98	16.1	3.3	19.4	20.33	4.12	24.45
Mar-99	19.1	3.2	22.3	23.28	3.94	27.21
Jun-99	20.0	3.4	23.3	24.74	4.17	28.91
Sep-99	20.8	3.5	24.3	23.42	3.95	27.37
Dec-99	21.5	4.0	25.5	26.57	4.96	31.53
Mar-00	21.3	4.1	25.4	26.51	5.14	31.65
Jun-00	21.7	4.3	26.0	26.53	5.23	31.76
Sep-00	23.1	4.4	27.6	26.64	5.07	31.72
Dec-00	22.8	4.5	27.4	25.89	5.16	31.05
Mar-01	24.1	4.3	28.4	26.64	4.78	31.42
Jun-01	24.4	4.7	29.1	27.19	5.21	32.40
Sep-01	25.4	4.9	30.3	29.14	5.64	34.78
Dec-01	25.9	4.9	30.8	30.12	5.69	35.81
Mar-02	26.8	4.6	31.4	32.04	5.56	37.60
Jun-02	26.7	4.8	31.5	33.92	6.12	40.04
Sep-02	32.1	4.7	36.7	39.63	5.76	45.39
Dec-02	32.0	5.1	37.1	40.41	6.50	46.92

continued on next page

Table 7.9 continuation

Date	Govt (in % GDP)	Corp (in % GDP)	Total (in % GDP)	Govt (USD billions)	Corp (USD billions)	Total (USD billions)
Mar-03	31.3	5.0	36.3	40.68	6.45	47.13
Jun-03	31.1	5.0	36.1	41.98	6.78	48.76
Sep-03	32.4	5.4	37.8	46.74	7.79	54.52
Dec-03	31.1	7.7	38.9	46.50	11.55	58.05
Mar-04	31.3	7.4	38.8	48.04	11.43	59.47
Jun-04	31.5	7.4	38.8	47.46	11.09	58.55
Sep-04	33.3	7.1	40.4	50.89	10.82	61.71
Dec-04	32.6	7.3	40.0	54.43	12.22	66.65
Mar-05	33.6	7.2	40.8	56.90	12.11	69.00
Jun-05	35.3	7.7	43.0	57.58	12.55	70.13
Sep-05	36.9	7.7	44.7	62.21	13.06	75.27
Dec-05	37.6	8.1	45.7	64.93	14.06	78.99
Mar-06	38.4	8.3	46.8	72.43	15.69	88.12
Jun-06	38.3	9.1	47.3	75.66	17.90	93.56
Sep-06	38.8	9.9	48.7	79.54	20.21	99.75
Dec-06	39.3	11.1	50.4	87.00	24.52	111.52
Mar-07	41.7	10.5	52.2	95.27	23.89	119.16
Jun-07	41.8	11.3	53.2	98.57	26.75	125.32
Sep-07	42.7	11.2	53.9	103.48	27.22	130.70
Dec-07	44.1	11.0	55.0	111.48	27.72	139.19
Mar-08	45.8	10.6	56.4	126.91	29.30	156.21
Jun-08	45.3	10.9	56.2	121.23	29.09	150.32
Sep-08	44.1	10.3	54.4	119.11	27.78	146.88
Dec-08	42.9	11.0	53.9	112.11	28.83	140.94
Mar-09	46.8	11.3	58.1	118.64	28.71	147.35
Jun-09	48.0	12.8	60.8	125.66	33.45	159.11
Sep-09	51.5	13.5	65.0	136.40	35.76	172.17
Dec-09	52.1	13.2	65.3	141.20	35.66	176.86
Mar-10	52.8	12.9	65.7	153.52	37.52	191.03
Jun-10	53.5	12.8	66.3	159.55	38.26	197.81
Sep-10	53.9	12.4	66.3	176.27	40.42	216.69
Dec-10	54.4	12.4	66.8	182.94	41.70	224.63
Mar-11	53.2	13.0	66.2	180.87	44.16	225.03

Source: AsianBondsOnline, Footnote 60. http://asianbondsonline.adb.org/thailand/data/bondmarket.php?code=LCY_in_GDP_Local

D. Size of Foreign Currency Bond Market in Percentage of Gross Domestic Product, Bank for International Settlement

Table 7.10 Foreign Currency Bonds to Gross Domestic Product Ratio

Date	as % of Gross Domestic Product (GDP)	Foreign Currency-Denominated Bonds (USD billion)	GDP (USD billion)
Dec-95	3.3	5.5	166.2
Dec-96	5.4	9.6	179.8
Dec-97	11.7	11.8	100.7
Dec-98	9.4	11.9	126.2
Dec-99	10.4	12.9	123.7
Dec-00	10.5	11.9	113.5

continued on next page

Table 7.10 continuation

Date	as % of Gross Domestic Product (GDP)	Foreign Currency-Denominated Bonds (USD billion)	GDP (USD billion)
Dec-01	8.6	10.0	116.1
Dec-02	7.9	10.0	126.4
Dec-03	6.1	9.1	149.4
Mar-04	5.3	8.2	153.5
Jun-04	5.7	8.7	150.8
Sep-04	6.1	9.3	152.7
Dec-04	5.8	9.7	166.7
Mar-05	5.8	9.8	169.3
Jun-05	6.8	11.2	163.2
Sep-05	6.3	10.7	168.6
Dec-05	6.2	10.8	172.9
Mar-06	5.7	10.8	188.4
Jun-06	5.7	11.3	197.6
Sep-06	5.8	11.8	204.9
Dec-06	5.1	11.3	221.3
Mar-07	4.7	10.7	228.4
Jun-07	4.1	9.6	235.7
Sep-07	4.0	9.6	242.3
Dec-07	3.7	9.4	252.9
Mar-08	3.5	9.6	277.1
Jun-08	3.5	9.4	267.6
Sep-08	3.5	9.3	270.1
Dec-08	3.4	9.0	261.4
Mar-09	3.4	8.7	253.4
Jun-09	3.4	8.8	261.6
Sep-09	3.3	8.7	264.7
Dec-09	3.1	8.5	270.9
Mar-10	2.9	8.3	290.7
Jun-10	2.7	8.0	298.2
Sep-10	2.5	8.2	326.9
Dec-10	2.4	8.1	336.2
Mar-11	2.5	8.4	339.7

Source: AsianBondsOnline. http://asianbondsonline.adb.org/thailand/data/bondmarket.php?code=FCY_in_GDP

E. Size of Foreign Currency Bond Market, Local Sources

Table 7.11 Foreign Currency Bonds Outstanding, Local Sources (USD billion)

Date	Government (USD billion)	Banks and Financial Institutions (USD billion)	Other Corporates (USD billion)	Total Foreign Currency (USD billion)
Mar-04	4.59	1.88	2.17	8.65
Jun-04	5.52	2.03	2.13	9.68
Sep-04	5.58	2.03	2.52	10.13
Dec-04	5.51	2.03	2.54	10.08
Mar-05	5.73	2.03	2.38	10.14
Jun-05	6.55	2.09	2.84	11.48
Sep-05	6.20	1.77	3.45	11.42
Dec-05	6.13	1.77	3.62	11.51

continued on next page

Table 7.11 continuation

Date	Government (USD billion)	Banks and Financial Institutions (USD billion)	Other Corporates (USD billion)	Total Foreign Currency (USD billion)
Mar-06	6.08	1.52	3.53	11.12
Jun-06	6.24	1.84	3.33	11.41
Sep-06	6.19	2.22	3.22	11.63
Dec-06	5.71	2.56	3.18	11.45
Mar-07	5.72	2.05	3.06	10.84
Jun-07	2.88	2.05	3.59	8.51
Sep-07	2.95	2.05	3.64	8.64
Dec-07	2.98	2.05	3.54	8.57
Mar-08	3.23	2.05	3.58	8.87
Jun-08	2.47	2.05	3.67	8.20
Sep-08	2.47	2.05	3.67	8.20
Dec-08	1.72	2.07	3.63	7.41
Mar-09	1.47	2.07	3.55	7.08
Jun-09	1.48	1.62	3.56	6.66
Sep-09	1.37	1.62	3.59	6.58
Dec-09	1.35	1.47	3.57	6.39
Mar-10	1.10	1.47	3.57	6.14
Jun-10	1.13	1.31	3.59	6.03
Sep-10	1.17	1.98	3.62	6.77
Dec-10	1.44	3.00	3.28	7.72
Mar-11	1.42	3.18	3.45	8.05

Source: AsianBondsOnline. http://asianbondsonline.adb.org/thailand/data/bondmarket.php?code=FCY_Bonds_Outstanding

F. Issuance Volume of Local Currency Bond Market

Table 7.12 Issuance Volume of Local Currency Bond Market (USD billion)

Date	Govt. (in USD billions)	Corp (in USD billions)	Total (in USD billions)
Mar-95	0.3907	0.3627	0.7533
Jun-95	0.5002	0.2038	0.7040
Sep-95	1.1175	0.7616	1.8791
Dec-95	1.3748	0.7666	2.1414
Mar-96	1.1876	0.1155	1.3031
Jun-96	2.0995	0.8286	2.9281
Sep-96	1.9485	0.6599	2.6084
Dec-96	2.4693	0.5097	2.9791
Mar-97	4.2876	0.1428	4.4305
Jun-97	3.5830	0.1820	3.7650
Sep-97	0.5229	0.1457	0.6686
Dec-97	0.4367	0.1044	0.5411
Mar-98	0.9256	0.0733	0.9989
Jun-98	4.6916	0.0576	4.7492
Sep-98	1.4119	0.0711	1.4830
Dec-98	5.7998	0.7970	6.5968

continued on next page

Table 7.12 continuation

Date	Govt. (in USD billions)	Corp (in USD billions)	Total (in USD billions)
Mar-99	3.2601	2.2012	5.4612
Jun-99	6.4198	2.6779	9.0978
Sep-99	1.5744	0.5113	2.0857
Dec-99	3.0153	2.3363	5.3516
Mar-00	1.2346	1.6844	2.9190
Jun-00	2.3304	0.6578	2.9882
Sep-00	3.7196	0.4277	4.1473
Dec-00	3.4378	1.0063	4.4441
Mar-01	8.2571	0.9264	9.1835
Jun-01	3.2244	0.5088	3.7332
Sep-01	3.4692	0.1566	3.6258
Dec-01	4.1584	0.7907	4.9491
Mar-02	4.4400	0.4414	4.8814
Jun-02	5.1542	0.1977	5.3520
Sep-02	10.1138	0.3915	10.5053
Dec-02	3.9753	1.2593	5.2346
Mar-03	4.7725	0.6667	5.4393
Jun-03	3.7262	1.0728	4.7990
Sep-03	5.0926	1.2266	6.3192
Dec-03	4.2288	1.8447	6.0734
Mar-04	6.0785	0.4473	6.5258
Jun-04	7.2968	1.0570	8.3538
Sep-04	9.4108	0.2387	9.6495
Dec-04	6.3967	1.4983	7.8950
Mar-05	9.5158	0.5990	10.1148
Jun-05	11.8062	1.6968	13.5030
Sep-05	11.7823	0.6731	12.4554
Dec-05	9.7225	1.7406	11.4631
Mar-06	13.4524	3.6373	17.0897
Jun-06	13.0906	5.4300	18.5206
Sep-06	13.6557	6.4401	20.0959
Dec-06	17.4549	8.2827	25.7376
Mar-07	42.0456	5.8512	47.8967
Jun-07	31.1880	9.3858	40.5738
Sep-07	39.3326	8.8741	48.2068
Dec-07	38.6566	9.9103	48.567
Mar-08	60.3590	9.3801	69.7391
Jun-08	79.0564	12.0193	91.0758
Sep-08	86.7390	8.8507	95.5897
Dec-08	72.9802	7.7924	80.7726
Mar-09	79.1154	5.4059	84.5214
Jun-09	79.4020	8.5343	87.9363
Sep-09	74.0677	7.3633	81.4310
Dec-09	57.4405	7.7038	65.1443
Mar-10	73.8476	6.2227	80.0703
Jun-10	70.6473	8.4827	79.1300

continued on next page

Table 7.12 continuation

Date	Govt. (in USD billions)	Corp (in USD billions)	Total (in USD billions)
Sep-10	91.1676	7.3938	98.5614
Dec-10	100.6942	8.9455	109.6397
Mar-11	105.9510	12.6381	118.5891
Jun-11	94.2306	9.8378	104.0684

Source: AsianBondsOnline. http://asianbondsonline.adb.org/thailand/data/bondmarket.php?code=Issuance_Volume_LCY

G. Foreign Holdings in Local Currency Government Bonds

Table 7.13 Foreign Holdings in Local Currency Government Bonds (THB billion)

Date	Foreign Holdings (THB billion)	Total (THB billion)	% of Total
Mar-03	5.895	1,205.714	0.49
Jun-03	8.379	1,208.865	0.69
Sep-03	14.281	1,262.357	1.13
Dec-03	15.479	1,214.282	1.27
Mar-04	23.454	1,221.262	1.92
Jun-04	25.447	1,232.255	2.07
Sep-04	28.242	1,430.236	1.97
Dec-04	27.553	1,414.176	1.95
Mar-05	33.005	1,432.745	2.30
Jun-05	36.141	1,430.157	2.53
Sep-05	31.933	1,531.149	2.09
Dec-05	45.275	1,559.649	2.90
Mar-06	47.496	1,635.195	2.90
Jun-06	72.543	1,685.044	4.31
Sep-06	47.566	1,730.778	2.75
Dec-06	47.132	1,729.477	2.73
Mar-07	23.707	1,835.216	1.29
Jun-07	12.893	1,835.566	0.70
Sep-07	5.518	1,833.671	0.30
Dec-07	16.090	1,873.902	0.86
Mar-08	34.207	1,940.598	1.76
Jun-08	51.177	1,983.035	2.58
Sep-08	61.249	1,987.562	3.08
Dec-08	55.565	1,931.562	2.88
Mar-09	53.730	2,187.210	2.46
Jun-09	55.320	2,241.923	2.47
Sep-09	78.888	2,380.537	3.31
Dec-09	76.298	2,362.102	3.23
Mar-10	95.269	2,470.979	3.86
Jun-10	108.515	2,566.677	4.23
Sep-10	157.458	2,596.700	6.06
Dec-10	187.473	2,594.930	7.22
Mar-11	213.283	2,546.577	8.38
Jun-11	227.844	2,557.284	8.91

Source: AsianBondsOnline. http://asianbondsonline.adb.org/thailand/data/bondmarket.php?code=Foreign_Holdings

H. Domestic Financing Profile

Table 7.14 Domestic Financing Profile

Date	Domestic Credit (% of Total)	Bonds (% of Total)	Equity (% of Total)	Domestic Credit (USD billion)	Bonds (USD billion)	Equity (USD billion)	Total (USD billion)
Dec-00	0	51.52	48.48	0	31.05	29.22	60.27
Dec-01	67.54	16.2	16.26	149.29	35.81	35.95	221.05
Dec-02	63.64	18.48	17.89	161.56	46.91	45.41	253.88
Dec-03	52.45	15.59	31.96	195.28	58.05	119.02	372.34
Dec-04	53.28	17.10	29.61	207.64	66.65	115.39	389.68
Dec-05	50.39	19.32	30.30	206.03	78.99	123.89	408.90
Dec-06	48.93	22.63	28.44	241.12	111.52	140.16	492.80
Mar-07	55.33	20.17	24.51	326.92	119.16	144.81	590.89
Jun-07	52.85	19.83	27.32	334.02	125.32	172.65	632.00
Sep-07	51.34	19.82	28.84	338.55	130.70	190.20	659.45
Dec-07	50.98	20.29	28.73	349.79	139.20	197.13	686.12
Mar-08	51.23	21.19	27.58	377.69	156.21	203.31	737.2
Jun-08	51.73	21.89	26.38	355.25	150.32	181.13	686.71
Sep-08	55.47	22.88	21.65	356.05	146.89	138.99	641.93
Dec-08	59.33	23.49	17.18	356.06	140.94	103.13	600.13
Mar-09	58.63	24.87	16.50	347.36	147.35	97.75	592.45
Jun-09	54.90	24.00	21.10	364.05	159.11	139.91	663.07
Sep-09	52.07	23.98	23.95	373.84	172.16	171.95	717.95
Dec-09	52.43	23.78	23.79	389.96	176.86	176.96	743.78
Mar-10	51.49	23.9	24.61	411.60	191.04	196.72	799.36
Jun-10	50.85	24.45	24.69	411.36	197.81	199.72	808.89
Sep-10	48.48	23.37	28.16	449.57	216.69	261.12	927.39
Dec-10	48.74	22.92	28.34	477.67	224.64	277.73	980.04
Mar-11	49.93	22.22	27.85	505.53	225.03	281.97	1,012.54

Source: AsianBondsOnline. http://asianbondsonline.adb.org/thailand/data/bondmarket.php?code=Domestic_Financing_profile

I. Trading Volume

Table 7.15 Trading Volume (USD billion)

Year	Govt Bonds	Corp Bonds	Total
Mar-01	10.82	0.29	11.11
Jun-01	7.73	0.69	8.42
Sep-01	6.99	0.67	7.66
Dec-01	7.97	0.39	8.36
Mar-02	9.34	0.52	9.86
Jun-02	10.30	0.51	10.81
Sep-02	13.67	0.52	14.19
Dec-02	14.61	0.56	15.17
Mar-03	13.90	0.96	14.86
Jun-03	15.65	0.86	16.51
Sep-03	15.44	1.18	16.62

continued on next page

Table 7.15 continuation

Year	Govt Bonds	Corp Bonds	Total
Dec-03	13.17	2.26	15.43
Mar-04	19.10	1.13	20.23
Jun-04	15.68	0.65	16.33
Sep-04	16.35	0.59	16.94
Dec-04	20.20	0.49	20.69
Mar-05	25.92	0.60	26.52
Jun-05	23.67	0.65	24.32
Sep-05	21.82	0.39	22.21
Dec-05	22.10	0.56	22.66
Mar-06	19.14	0.5	19.64
Jun-06	19.75	0.41	20.16
Sep-06	27.86	0.71	28.57
Dec-06	46.26	0.86	47.12
Mar-07	66.02	1.19	67.21
Jun-07	70.55	1.17	71.72
Sep-07	81.06	1.00	82.06
Dec-07	85.02	0.56	85.58
Mar-08	125.00	0.83	125.83
Jun-08	136.99	1.01	138.00
Sep-08	138.63	0.64	139.27
Dec-08	116.21	0.98	117.19
Mar-09	115.43	1.45	116.88
Jun-09	112.61	1.15	113.76
Sep-09	97.99	1.29	99.28
Dec-09	94.77	1.02	95.79
Mar-10	116.09	1.56	117.65
Jun-10	110.59	1.13	111.72
Sep-10	143.28	1.61	144.89
Dec-10	157.31	1.40	158.71
Mar-11	163.09	2.08	165.17
Jun-11	0.13	1.34	1.47

Source: AsianBondsOnline. http://asianbondsonline.adb.org/thailand/data/bondmarket.php?code=Trading_Volume

VIII. Presence of an Islamic Finance (Islamic Bond [*Sukuk*]) Market

A. Current Development of an Islamic Bond Market in Thailand

Thailand is at the early stage of developing an Islamic bond market. The specific regulations for issuance and offering of *Sukuk* were announced in early January 2011. The regulatory framework is under the *Securities and Exchange Commission Act* and the *Trust for Transactions in Capital Market Act*.

B. Regulations on Plain Vanilla *Sukuk*

Thailand has just launched regulations for plain vanilla *Sukuk* for Thai issuers only. Regulations on issuance of plain vanilla *Sukuk* are in line with regulations for bond issuance on approval criteria, filing criteria, credit rating requirement, and tax issues. However, *Sukuk* do not have a shelf registration regime. Issuers have to get approval from the Securities and Exchange Commission (SEC) for every new issue.

C. Specific Regulation on *Sukuk*

A *Shariah* advisor has to certify whether the *Sukuk* structure is *Shariah* compliant. A financial advisor has to certify the qualification of the *Shariah* advisor, and a legal advisor has to certify that a trust deed shall be enforceable under Thai law.

D. Infrastructure for *Sukuk*

Sukuk mostly have the same infrastructure as for bonds such as the trading venue, which can either be on the over-the-counter (OTC) market or the Bond Electronic Exchange (BEX).

IX. Brief History of Debt Market Development

A. Measures for Bond Market Development

Under the Capital Market Development Committee, measures for bond market development can be summarized as follows:

1. Development of the Government's Cash Management Methods and Study

Alternatives of amending laws relating to the treasury reserve are regularly explored so that the government can issue Treasury bills efficiently. Also, this will help decrease the cost of funds that the government faces.

2. The *Rural Decentralization Act*

The *Rural Decentralization Act* has empowered local administrative bodies to raise funds from the bond market for the development of public utilities. However, in practice, only large urban administrative bodies, such as the Bangkok Metropolis, Chiangmai, Phuket, and others are capable of doing so. These administrative bodies may issue revenue bonds to and redeem the capital investment plus interest from investors with income from public utilities.

3. Development of Private Repo and Security Borrowing and Lending

One way to improve liquidity of bond instruments is the promotion of private repo and Securities Borrowing and Lending (SBL). The Bank of Thailand (BOT) have been taking the lead in promoting these transactions provided by institutional investors who heavily invest in bonds, entered into, such as funds and insurance companies etc. These bonds will be used as a tool for monetary policy through bilateral repo with primary dealers (PDs) of the BOT. These PDs are able to carry forward this transaction through the exchange or private repo. In the future, there will be an expansion of the private repo base to include non-banking institutions, private enterprises, and foreign investors. This strengthens the secondary market by injecting more liquidity and activities in the private repo market.

X. Next Steps ⇔ Future Direction

A. Capital Market Master Plan (2002)

The government launched Thailand's first Capital Market Master Plan in early 2002 in an effort to develop and diversify the country's sources of funds. The plan outlined broad initiatives that are considered as the main policy framework for the Thai capital market development. These initiatives include promoting good governance, enlarging the investor base, increasing the quantity and variety of financial instruments, enhancing infrastructure, and reforming the supervisory system.

B. Capital Market Master Plan II (2006)⁴⁴

The second phase of the plan was released in February 2006 covering the period 2006 to 2010. It was proposed by the Federation of Thai Capital Market Organizations (FeTCO) and government bodies related to the Thai Ministry of Finance (MOF) to the MOF. The proposed plan emphasizes principal measures to develop and strengthen the Thai capital market to be ready for changes in the global markets. The proposal was also seen to make the capital market become more stable to support the growth of the economy in a more sustainable manner.

Thailand's Minister of Finance, Dr. Thanong Bidaya, chaired the workshop on developing the Thai Capital Market Master Plan II held on 1 February 2006. According to Dr. Thanong,

The government still emphasizes the continued development of the Thai capital market to be in line with international standards. The Thai Capital Market Master Plan II will be for the 5-year period from 2006-2010. It will essentially make the Thai capital market an efficient channel for fundraising, as well as a good savings choice. It will not only help increase the overall market capitalization, but will also improve price stability.

⁴⁴ Bank of Thailand. 2006. *Thailand's Financial Sector Master Plan Handbook*. <http://www.bot.or.th/Thai/FinancialInstitutions/Highlights/MasterPlan/Documents/FSMP.pdf>

The seven principal measures under the master plan include the equity, bond, and derivatives markets. Also, it involves listed companies, intermediaries, investors, as well as the supervisory bodies. The goals of this second phase plan include increasing the proportion of institutional investors from the current 10% of the total turnover to 20%; working with the SET 100 companies to adjust their price-earnings (P/E) ratios to make their P/E better reflect their actual value; working with the SET100 as well as other large-scale companies whose major shareholders are the public sector; and raising the standards of listed companies by offering incentives and privileges.

As for the bond market, it will be continue to be promoted to encourage its growth to enable it to attain the same volume as the money market. Greater participation by retail investors will also be encouraged. More market product innovations such as derivatives instruments and securitization will be introduced. These innovations will help reduce the risks of both entrepreneurs and investors.

To help strengthen intermediary institutions, their capabilities will be improved so that they become better versed in offering integrated products and have a more suitable capital base prior to opening up for foreign competition.

The liberalization of trading fees will also be undertaken on a step-by-step basis, provided that the types and sizes of transactions are carefully considered. Business operators will therefore have sufficient lead time to prepare or adjust to the liberalization.

With regards to raising the standards of corporate governance, there will be incentives and education schemes to help push forward this effort. It is targeted that education outreach efforts will cover every academic institution in the country by 2010.

The SEC and the SET will be developing as well as supervising the capital market. Adjustments of rules or regulations to further improve the market's accessibility, and to bring it in line with current trends, products and technologies, will be considered.

C. Capital Market Masterplan (2009)⁴⁵

The most recent Capital Market Masterplan was detailed by the Thai Ministry of Finance in a press release on 4 November 2009: the Economic Cabinet approved the Capital Market Masterplan as proposed by the Capital Market Development Committee, which is chaired by the Minister of Finance.

The capital market is important to a country's economic and social system. It plays the crucial roles of capital raising for both public and private sectors, promoting balance and stability in the financial system, decreasing dependency on the banking sector, driving the economy forward and creating jobs, as well as being an alternative method for savings. A strong capital market will lessen the impact of economic fluctuations which can be compounded by the fast-flowing nature of capital. However, there are still many issues besetting the Thai capital market. Few institutional investors, small

⁴⁵ Footnote 13. http://www2.mof.go.th/press_releases_detail.php?id=21; Footnote 14. http://www.set.or.th/en/about/vision/files/Executive_Summary.pdf

retail investor base, limited financial products, high transaction costs, and lack of efficient regulatory enforcement are some examples. Moreover, Thailand's capital markets in recent times have grown at a very slow pace. The size of the stock market compared to the gross domestic product (GDP) is only 51% as of June 2009, which is smaller than other countries in the region such as Hong Kong (845%), Singapore (202%), Malaysia (104%), and South Korea (66%). Should this trend continue, Thailand's capital market will stagnate and become increasingly marginalized. Various studies have shown that inadequate development of the capital markets will impact its ability to raise, channel and monitor resources efficiently. In the end, this will lead to loss of growth opportunities, standard of living and prosperity.

In recognizing the importance of the capital market, Prime Minister Abhisit Vejjajiva appointed the Capital Market Development Committee (The Committee) on 27 January 2009. This appointment is a continuation from the committee appointed on 25 March 2008. The Committee is tasked with formulating an overall master plan for the development of Thai capital market as well as monitoring the implementation of such plan. The Committee comprises of the Minister of Finance as the chairperson and experts from public and private sectors.

In formulating the Capital Market Development Masterplan (The Masterplan), the Committee solicited inputs and opinions from all stakeholders, and formed the vision and the 5-year development objectives (2009-2013) as follows:

- (i) The Thai capital market is the primary mechanism for aggregating, channeling, and monitoring economic resources.
- (ii) The goal of the capital market is to perform these tasks efficiently to increase overall competitiveness of Thailand.

The Committee has formulated six primary missions and objectives to realize this vision:

1. Six Primary Missions

- a. The capital market must be easily accessible to investors seeking investment opportunities and corporations seeking funds.
- b. Increase quality and variety of products and services.
- c. Reduce cost of funds to issuers and any intermediary and transaction costs to investors to enable Thai companies to become more competitive.
- d. Develop efficient infrastructure framework in legal, regulations, accounting, tax, information, technology, and enforcement.
- e. Educate investors and ensure that adequate protection mechanisms are in place.
- f. Promote competition in the Thai capital market and build links with the global market system.

2. Eight Important Reform Measures

The Masterplan consists of eight important reform measures that will affect the course of development and bring about major changes in the system.

a. Measure 1: Abolish the Monopoly and Improve Competitiveness of the Stock Exchange of Thailand

Liberalization of capital flows and competitive pressure increase the chances of the SET being marginalized. To make the SET responsive to fast-changing business environments, its business structure must be transformed to increase efficiency and promote competitiveness. The first step is to demutualize the SET, convert it into a public company (The Exchange Company), separate the exchange business from capital market development work, and establish a Capital Market Development Fund (CMDf) with the mission of long-term capital market development. The SET's monopoly on exchange businesses will also end. Therefore, there may be other trading platforms permitted to trade listed stocks.

The Exchange Company will be allowed to permit persons other than securities firms incorporated in Thailand to have direct access if it wishes to in order to increase liquidity and expand the investment base to promote linkage with the global capital market, and decrease limitations which currently obstruct the growth of Thai capital market.

b. Measure 2: Liberalization of Securities Business to Promote Market Efficiency

This measure, while in line with recent trends of liberalization in the financial system, also aims to increase the competitiveness of the Thai capital market and enable it to withstand the impact of fast capital flow. Liberalization of licenses will foster market competition. Securities firms will have to adjust by forming alliances with strategic partners to increase its efficiency by offering new products in the long run.

c. Measure 3: Reforming Legal Framework

Currently, there are draft laws relating to the capital market being proposed to the House of Representatives which are:

- (1) *Amendment Act to Royal Enactment on Special Purpose Juristic Persons for Securitisation B.E.*,
- (2) *The Draft of Commercial Collateral Act B.E.*, and
- (3) *The Amendment Act to the Civil and Commercial Code B.E.*

The government should keep pushing for passage of these laws.

The Committee also had the resolution to propose further reforms, including:

- (1) Laws to facilitate mergers and acquisitions activities,
- (2) Adopt civil penalty, and
- (3) Amend the *Civil Procedure Code* to include class action lawsuits, which would help make enforcement of the *Securities and Exchange Act* more efficient.

d. Measure 4: Streamline the Tax System

This measure aims to make the tax system more efficient to transactions, improve fairness, and provide tax incentives for transactions that the state would like to promote for the development of capital market. Taxation areas to streamline include those related to mergers and acquisitions, investments in debentures, elimination of double taxation on dividends, equalize tax incentives on direct investment and investment through intermediaries, transfer of investments in provident funds, public savings funds, life insurance premiums, Islamic bonds, securities borrowing and lending of the BOT, and venture capital.

e. Measure 5: Develop Financial Products

Currently, the Thai capital market has few financial products to choose from, which cannot take care of the diverse needs of investors, thus making the market relatively unattractive. This measure aims to push for the development of new products which would help increase the variety of instruments and consequently help develop the market. Examples of new products are infrastructure fund to promote investments by the private sector, life annuities, interest rate derivatives, inflation-indexed government bonds, Islamic bond, venture capital, and divestiture of MOF's shares of publicly traded companies.

f. Measure 6: Establishment of a National Savings Fund

The MOF proposed a *National Savings Fund Act*, and the cabinet, in a meeting on 20 October 2009 agreed to the first draft. The National Savings Fund will cover workers outside the formal system comprising approximately 70% of the total labor force of Thailand. The objective is to institutionalize savings for retirement, create equality of opportunity, and ensure that these informal sector workers are provided with some income after retirement. The National Savings Fund will become a major source of savings and investments in Thailand and will contribute to the development of Thai capital markets. It will help lessen the volatility of capital movements and also indirectly promote new financial products.

g. Measure 7: Developing a Culture of Savings and Investments

This measure aims to provide choices when investing in provident fund and Government Pension Fund, so that investors' needs are met. It will also encourage investors to be proactive about acquiring new knowledge on financial products so that investors can truly determine what types of products suit them.

h. Measure 8: Development of the Domestic Bond Market

This measure aims to develop the government's cash management methods and study alternatives to amending laws relating to treasury reserves, so that the government can issue treasury bills efficiently. The government should also be able to manage treasury reserves for yields by such means as depositing the reserves with other institutions instead of the BOT. This will help decrease the cost of funds that the

government faces. Moreover, the BOT will take the lead in developing and promoting the private repo and securities borrowing and lending markets, providing the bond market with another tool to manage liquidity efficiently with low risks. Overall, this would lead to further growth in the market.

Aside from the eight reform measures, the Masterplan consists of 34 further measures that should be implemented. These measures are important in changing the basic framework and developing new infrastructures in the long run, which would lead to the fulfillment of the Masterplan's main objectives.

After the Masterplan has been approved, the drafting subcommittee will transform into the Implementation and Oversight Committee charged with overseeing, monitoring, and assessing the implementation of the Masterplan. The new committee will use key performance indicators to assess the progress and efficiency of implementation.

The Committee believes that success in implementing the Masterplan, aside from directly benefiting the capital market, will have far-ranging benefits to society and economy as a whole. It will improve competitiveness, promote savings and retirement planning, improve linkage between Thai and global capital markets, and benefit all sectors of society. The results will be reflected and noticeable in the capital market structure itself. The Thai capital market will grow larger with more liquidity, which will strengthen balance and stability of the financial market. It will become a key driver in economic development, which will be observable in the prosperity of Thai people in the long run.

D. Future Direction

In December 2010, the BOT signed an agreement with the SEC, the SET, the Thai Bond Market Association, and the Public Debt Management Office (PDMO) to create the Thailand Financial Instruments Information Center (TFIIC). TFIIC is part of the Thai government's 5-year Capital Market Masterplan, which aims to collect information on financial instruments by related sources, share information, and provide linkages among related agencies.

E. Group of 30 Compliance

“The so-called G-30 Recommendations were originally conceived as the Group of Thirty's Standards on Securities Settlement Systems in 1989, detailing in a first of its kind report nine recommendations for efficient and effective securities markets and covering legal, structural and settlement process areas. The recommendations were subsequently reviewed and updated in 2001, under leadership of the Bank for International Settlements (BIS), and through the efforts of a Joint Task Force of the Committee On Payment and Settlement Systems (CPSS) and the Technical Committee of the International Organisation of Securities Commissions (IOSCO). Compliance with the G30 Recommendations in individual markets is often an integral part in securities industry participants' and intermediaries' due diligence process.”

Table 10.1 Group of Thirty Compliance Recommendations

G-30 Compliance Recommendation		Implemented
1	Eliminate paper and automate communication, data capture, and enrichment	Yes
2	Harmonize messaging standards and communication protocols	Yes
3	Develop and implement reference data standards	Yes
4	Synchronize timing between different clearing and settlement systems and associated payment and foreign exchange systems	Yes
5	Automate and standardize institutional trade matching	Yes
6	Expand the use of central counterparties	Yes
7	Permit securities lending and borrowing to expedite settlement	Yes
8	Automate and standardize asset servicing processes, including corporate actions, tax relief arrangements, and restrictions on foreign ownership	Yes
9	Ensure the financial integrity of providers of clearing and settlement services	Yes
10	Reinforce the risk management practices of users of clearing and settlement service providers	Yes
11	Ensure final, simultaneous transfer and availability of assets	Yes
12	Ensure effective business continuity and disaster recovery planning	Yes
13	Address the possibility of failure of a systematically important institution	Yes
14	Strengthen assessment of the enforceability of contracts	Yes
15	Advance legal certainty over rights to securities, cash, or collateral	Yes
16	Recognize and support improved valuation methodologies and closeout netting arrangements	Yes
17	Ensure appointment of appropriately experienced and senior board members (of the boards of securities clearing and settlement infrastructure providers)	Yes
18	Promote fair access to securities clearing and settlement networks	Yes
19	Ensure equitable and effective attention to stakeholder interests	Yes
20	Encourage consistent regulation and oversight of securities clearing and settlement service providers	Yes

Source: Group of 30 (G30). 2003. *Global Clearing and Settlement – A Plan of Action*. <http://www.partad.ru/wrld/word/g30app1.pdf>

F. Group of Experts Barrier Report Market Assessment – Thailand (April/2010)

“The GoE Report refers to the published results in 2010 of the Group of Experts (GoE) formed under Task Force 4 of the Asian Bond Market Initiative (ABMI). In the report, published under the leadership of the Asian Development Bank (ADB), a group of securities market experts from the private and public sector in ASEAN+3 as well as International Experts, assessed the ASEAN+3 securities markets on potential market barriers, the costs for cross-border bond transactions and the feasibility for the establishment of a Regional Settlement Intermediary (RSI). The findings in the GoE Report lead to the creation of ABMF.”

Table 10.2 Group of Experts Barrier Report Market Assessment – Thailand

Potential Barrier area	Current situation	Market Assessment Questionnaire scores	Overall barrier assessment
Quotas	There are no restrictions on foreign investment in local bonds.	OK	OK
Investor registration	There is no requirement for foreign investor registration. However, the documentation required for custodian account opening in Thailand needs to be notarised and consularised. Account-opening is a costly and time-consuming process. These documents are also required by the registrar agents for bond re-registration, and for some corporate events. Documents must be updated every year. This is strictly speaking not an investor registration issue.	OK	OK

continued on next page

Table 10.2 continuation

Potential Barrier area	Current situation	Market Assessment Questionnaire scores	Overall barrier assessment
FX controls - conversion	FX must be linked to securities trades. Each FX (or non-FX related payment transaction) equal to or greater than USD 20,000 must be reported by the sub-custodian to the Bank of Thailand (BoT), stating the purpose of the transaction. Foreign investors may net security transactions against a single foreign exchange, provided that all the settlement dates are the same. Same-day, next day and forward value FX are permitted if there is an underlying transaction. If there is no underlying transaction, then for buying THB from a commercial bank, FX is permitted up to THB 300 million across accounts per entity group, and for selling THB to commercial banks FX is permitted up to THB 10 million across accounts per entity group. Spot FX is permitted with no underlying transaction. Third party FX trades with resident financial institutions require proof of relevant underlying investment activity. However, while third party FX is permitted, it may not be supported by custodians. Investors commented that currency controls are a problem and that FX is difficult.	LOW	LOW
FX controls - repatriation of funds	As noted above, FX must be supported by an underlying securities transaction. Otherwise, for selling THB to commercial banks, FX is permitted up to THB 10 million across accounts per entity group.	LOW	LOW
Cash controls - credit balances	Many banks or investors must have two types of accounts (NRBS and NRBA), therefore there is more reporting and control. Funds must be managed separately and cannot be transferred across account type. Cash balances held by foreign investors are capped at THB300 million (c USD 9 million) across all accounts for the same account type (NRBA and NRBS) per custodian bank. The BoT may force non-resident investors to sell THB in excess of this limit to the BoT at the penalty rate. Many investors mentioned Thailand as a problem in this area.	HIGH	HIGH
Cash controls - overdrafts	Overdraft facilities provided by Thai financial institutions to foreign investors are capped at THB300 million (c USD 9 million) per group of non-residents per custodian bank. The BoT must approve the use of overdraft facilities and an investor's use of a facility must be based on extenuating circumstances such as clerical errors. Foreign investors are not permitted to overdraw their THB cash accounts for the purpose of funding securities settlement. Custodian banks can request for 1 day long balance on behalf of non resident investor if there is an evidence of next day trade or it is a US public holiday, etc. The monitoring is manual and difficult to control operationally and as a result, commonly not offered to the investors. Several investors mentioned Thailand as a problem in this area.	LOW	LOW
Taxes	All non-resident investors are exempted from withholding tax on interest and capital gains tax from government and government agency bonds. Corporate bond interest (including state enterprise bonds) is taxed at 15%, withheld at source. The tax may be exempted or reduced by tax treaties.	LOW	LOW
Omnibus accounts	Omnibus accounts are allowed.	OK	OK
Settlement cycle	The settlement cycle for bonds is T+2 (or by agreement)	OK	OK
Message formats	The Thailand Securities Depository (TSD) uses SWIFT format for settlement messages but not for corporate event messages. Local market participants in general do not use SWIFT, apart from custodians.	LOW	LOW
Securities numbering	ISIN are available for all local bond issues, and are available on issue date. SWIFT and ISIN codes are used among banks and custodians in instructions for bonds. However, investors commented that this area was a problem as most market players were still using the local codes. Several market participants mentioned Thailand as a problem in this area.	OK	LOW
Matching	There are trade matching and settlement pre-matching systems for bond trades.	OK	OK
Dematerialisation	All government (and some corporate bonds - depending on the registrar agents) are dematerialised.	LOW	LOW
Regulatory framework	The perceived regulatory risk, especially fear of capital controls, is a factor that deters foreign investors. Investors commented that the regulations can be complex and unclear, and that regulations are changed too often and sometimes without enough notice.	-	HIGH

Source: Asian Development Bank. 2010. *Asian Bond Markets Initiative Group of Experts Final Report: Barriers to Cross-Border Investment and Settlement in the ASEAN+3 Bond Markets*. [https://wpqr1.adb.org/LotusQuickr/asean3goe/Main.nsf/h_58E34A1388F9070B48257729000C0A4E/90F408746827C16248257729000C1334/\\$file/Part3.pdf](https://wpqr1.adb.org/LotusQuickr/asean3goe/Main.nsf/h_58E34A1388F9070B48257729000C0A4E/90F408746827C16248257729000C1334/$file/Part3.pdf)

Appendixes

Appendix 1. “Survey on Primary Market Questions for IOSCO Jurisdictions”

Box A1. Survey on Primary Market Questions for IOSCO Jurisdictions

IOSCO EMERGING MARKETS COMMITTEE
TASK FORCE ON DEVELOPMENT OF CORPORATE BOND MARKETS
(Joint Project with the World Bank)

PLEASE SEND YOUR RESPONSES NO LATER THAN JANUARY 7, 2011.

Questions on Primary Market Issuance of Corporate Bonds

1. Assuming you have both public and private issuance regimes, do you also have a type of “hybrid regime” in place for corporate bonds? Hybrid regimes provide an exemption from filing a full prospectus but may require filing a simplified or short-form prospectus or other registration/information document. They can be based on either private or public issuance regulations but contain elements of both (e.g., private issue with secondary market trading). Hybrid regimes can take different forms. A common type entails a prospectus-exempt public offer if an issue is targeted solely at qualified investors or the denomination size is sufficiently large (e.g., []50,000 in the EU), ensuring nonparticipation of retail investors. Another example is the US Rule 144A market, where private placements are allowed to be traded among qualified investors. Because one of the conditions for prospectus exemption is for an offer made solely to institutional investors, this may be known as an Institutional Offerings regime in your country.

Yes, we have a type of hybrid issuance regime as known as Private Placement: Institutional and High Net worth Offerings regime.

2. What is the estimated extent of use of each of the different issuance regimes based on percent of total issuance? (Please fill in for “pure public offer” and “pure private placement” even if you do not have a hybrid regime.)

- Pure Public Offer 44%
- Pure Private Placement 11%
- Hybrid Regime (PP: II & HNW) 45%

If you answered yes to question 1, please proceed to the next set of questions.

Questions on the Hybrid Issuance Regime:

Prospectus Exemption

3. Is the hybrid regime based on private or public issuance regulations (i.e., is it a public offer with prospectus exemption or is it a private placement with public elements, such as permission to list and trade in the secondary market)? Please explain.

It is a private placement with public elements to list and trade in the secondary market.

continued on next page

Box A1 continuation

4. What key law or regulation established the hybrid regime (e.g., Regulation D and Rule 144A in the U.S.; Prospectus Directive in the EU) and in what year?

Notification of the Securities and Exchange Commission No.KorChor 4/2552
 Re: Exemption from Filing of Registration Statement for the Offer for Sale of Debt Securities
 Dated March 31, 2009

Notification of Capital Market Supervisory Board No.TorChor 9/2552
 Re: Application for and Approval of Offer for Sale of Newly Issued Debt Securities
 Dated March 31, 2009

Notification of Capital Market Supervisory Board No.TorChor 10/2552
 Re: Filing of Registration Statement for Offer for Sale of Debt Securities
 Dated March 31, 2009

5. What are the key conditions for prospectus exemption (examples include: offers addressed solely to qualified investors, offers with a large denomination amount per unit, etc.). Please list all applicable conditions and provide explanations as necessary.

Characteristics of the Offer for Sale of Debt Securities under Exemption from filing of the registration statement and draft prospectus with the Office:

- 1) an offer for sale of corporate bonds with the following characteristics:
 - (1) an offer for sale of newly issued corporate bonds which is not opposed to the transfer restriction filed with the Office in any of the following manners:
 - (a) an offer for sale to no more than ten investors within any four-month period;
 - (b) an offer for sale of the whole amount of corporate bonds to institutional investors established or certified under foreign law;
 - (c) an offer for sale to the person who has been the company's creditor prior to the offer for sale for the purpose of debt restructuring;
 - (d) an offer for sale of corporate bonds as being granted an exemption by the Office due to necessity and appropriateness which does not affect the general public and investor protection measures are provided adequately;
 - (2) an offer for sale of corporate bonds in any succeeding step in any of the following manners:
 - (a) an offer for sale of corporate bonds which is not opposed to the transfer restriction filed with the Office. In case of an offer for sale of corporate bonds with restriction of transfer among institutional investors or high net worth investors, credit rating shall be arranged for such bonds;
 - (b) an offer for sale of corporate bonds without transfer restriction which meets the following conditions:
 1. the registration statement and the draft prospectus for the offer for sale of such bonds have been filed at the first step of offering;
 2. the issuer has adequately provided continual information disclosure;
 3. the corporate bonds being offered for sale has credit rating arrangement
6. Does the law/regulation make any kind of distinction between debt and equity offerings or is the prospectus exemption provided to all securities equally with similar terms and conditions?

There is a distinction between debt and equity offerings.

7. Does the law/regulation make a distinction between retail and professional investors? The latter can be institutional investors or qualified investors (including natural persons) defined by a specific criteria. (For example, in the US, there are three levels of professional investors: Sophisticated Investor, Accredited Investor, and Qualified Institutional Buyer.)

Yes

- 1) If yes, please explain any segmentation of investors on a spectrum ranging from non-professional (retail) to most professional and indicate which ones apply to the hybrid regime.
 1. Non-professional investors
Retail
 2. Professional investors
High net worth => hybrid regime
Institutional investors => hybrid regime
- 2) What is the definition (criteria) of a professional investor for the purposes of the hybrid regime/prospectus exemption?
 - (1) "Institutional investors" means:
 1. commercial banks;
 2. finance companies;
 3. securities companies for management of proprietary portfolios or private funds or investment projects established under laws governing finance business, securities business and credit foncier business;
 4. credit foncier companies;
 5. insurance companies;
 6. government units and state enterprises under laws governing budgetary procedures or any other juristic persons established under specific laws;

continued on next page

Box A1 continuation

7. Bank of Thailand;
8. international financial institutions;
9. Financial Institutions Development Fund;
10. Government Pension Fund;
11. provident funds;
12. mutual funds;
13. foreign investors with the same characteristics as investors under (1) to (12), mutatis mutandis;

(2) "High net worth investors" means:

1. individual persons having forty million baht or more of assets, excluding liabilities of such persons;
2. juristic persons having two hundred million baht or more of assets as recorded in the latest audited financial statements

8. Do you have suitability tests in place for classification of investors according to different levels of professionalism?

No.

9. Under the hybrid regime, does the issuer have to file any form of simplified or short-form prospectus or registration form with the regulator?

Yes.

- a) If so, does this document need to be approved by the regulator or is it simply a notification for the purposes of registering the information with the regulator? Please explain.

Yes. An offeror of debt securities shall file with the Office registration statement in three copies together with draft prospectus. For an offer of corporate bonds to institutional investors or high net worth investors with registration of transfer restriction among such groups of investors, Form 69-S (short-form registration statement) shall be filed prior to each offer.

- b) If the document needs to be approved by the regulator, what is the timeframe within which the approval has to be made?

Filing of Form 69-S and draft prospectus shall become effective within the next business day after the date of filing such registration statement and draft prospectus in full.

Transferability / Secondary Market Trading

10. Does the regulation allow for a security issued via the hybrid regime to be traded?

Yes.

- a) If so, what are the conditions for trading (i.e., is there a holding period, can it only be traded among professional/qualified investors, etc.)?

It can only be traded among institutional investors or high net worth investors.

- b) If not included in the conditions for trading, is there a distinction between retail and professional investors? Please explain.

- c) What is the definition of professional investor, if different from the issuance (i.e., initial prospectus exemption) stage?

11. In practice, are securities issued via the hybrid regime commonly traded in the secondary market?

Yes.

Listing

12. Does the regulation allow for the securities issued via the hybrid regime to be listed and traded on a stock exchange?

Yes.

- a) If so, is there a special segment of the exchange where they are listed/traded?

Corporate Bond segment in BEX.

13. Please describe the conditions, if any, that need to be met in order to list a security issued via a hybrid regime on the exchange (e.g., disclosure of specified information, etc.)

continued on next page

Box A1 continuation

The condition is a corporate bond which can be transferred only to institutional investors or high net worth investors.

- a) Are these conditions less onerous than those required for public issues or are they the same?

Yes.

Continuous Disclosure

14. Are hybrid regime issuers subject to any continuous disclosure requirements? Please answer for the three scenarios below.

In general => the issuer shall have duty to prepare and submit the following reports on financial position and operational result to the Office:

- (1) quarterly financial statement reviewed by an auditor;
- (2) financial statement for any accounting period examined and for which an opinion has been given by an auditor;
- (3) annual report;
- (4) any other reports concerning the information of the company as specified in the notification of the SEC.

Intermediary Obligations

15. Does the regulatory framework provide the securities regulator with the mandate to intervene in case of false or misleading statements related to securities issued via:

- The hybrid regime?
- The pure private placement regime?

Prior to closing of an approved offer for sale of debt securities, if the offeror has disclosed material facts which are not stated in registration statement and draft prospectus to any specific person for the purpose of analyzing the appropriateness of investment in the offered debt securities or making decision to invest in the offered debt securities, the offeror shall proceed to disclose such facts in registration statement and draft prospectus immediately. In this regard, the disclosure shall be made no later than the effective date of registration statement or, in cases where registration statement has already become effective, no later than the following business day as from the day on which such facts are disclosed to such particular person.

- a) If not, are intermediaries (e.g., investment banks underwriting new issues) held accountable for providing accurate and truthful information through some other regulatory avenue?

Investment

16. Are regulated institutions allowed to invest in securities issued via the hybrid regime? Please provide an answer for each, explaining any limitation (e.g., limit of 10% of total assets)

- Pension funds:
- Insurance companies:
- Mutual / investment funds: 15% of NAV, if the issues obtain rating of investment grade.
- Banks:

17. Are regulated institutions allowed to invest in securities issued via the pure private placement regime? Please provide an answer for each, explaining any limitation (e.g., limit of 10% of total assets)

- Pension funds:
- Insurance companies:
- Mutual / investment funds: 15% of NAV, if the issues obtain rating of investment grade and listed at the ThaiBMA.
- Banks:

Source: Securities and Exchange Commission Thailand

Appendix 2. ASEAN Bond Market Development Scorecard: Thailand

Table A1.1 ASEAN Bond Market Development Scorecard: Thailand

	ASEAN Bond Market Development Scorecard	Regulatory / Market Development	Resident / Non-Resident / Both	Thailand	
				✓=Yes X=No	
A	ISSUER				
1	Market Access				
a)	Acceptance of MTN programmes	Reg	Both	✓	
ai)	International MTN programmes	Reg	Both	X	MOF is considering this issue. Applying the international MTN program may work against the MOF's objectives of balancing the financial system, given the risk that the MTN program may hinder development of less-developed domestic bond markets, levels of development across the region remain unequal. Furthermore, in instances where domestic liquidity is tight, it may raise the cost of raising funds in the domestic market.
aii)	Local MTN programmes	Reg	Both	✓	Shelf filing
b)	Removal of discriminatory restrictions on issuance by non-residents	Reg	Non-resi	✓	Thailand has opened up for NR issuers; however, approval remains subject to MOF and BOT's consideration (use of proceeds, credit rating, and overall financial system liquidity). Thai SEC has adopted ASEAN standard, which means a Singaporean firm may submit the filing document used in Singapore to the Thai SEC, for bond issuance in Thailand.
2	Transparency				
a)	Disclosure standards - Adoption of ASEAN and Plus Standards	Reg	Both	✓	
ai)	Accounting standards - Adoption of IFRS for cross-border offerings	Reg	Both	✓	ASEAN Standard (form 69-FD, or 69-base)
aii)	Auditing standards - Adoption of ISA for cross-border offerings	Reg	Both	✓	ASEAN Standard (form 69-FD, or 69-base)
B	INVESTOR				
3	Market Access				
a)	Non-resident market access	Reg	Non-resi	✓	
ai)	Elimination of investor registration requirements	Reg	Non-resi	✓	
aii)	Removal of discriminatory restrictions on investment by non-resident investors	Reg	Non-resi	✓	
aiii)	Removal of discriminatory restrictions on non-resident institutional investors' portfolio composition	Reg	Non-resi	✓	
aiv)	Removal of restrictions on non-resident LCY borrowing (i.e. intraday credit/overnight credit, etc.)	Reg	Non-resi	X	NRs can obtain Baht through swap transaction.
b)	Removal of investment restrictions on resident investors	Reg	Resi	✓	
c)	Existence of clear legislation on bond holders' rights	Reg	Both	✓	Details about bondholders' rights are stated in the prospectus. It is easy access to both prospectus and covenants governing bondholders' rights through the SEC and issuers website. In addition, there is a regulation on bondholders' representative to ensure that bondholder rights are clearly defined and therefore protected.

continued on next page

Table A1.1 continuation

	ASEAN Bond Market Development Scorecard	Regulatory / Market Development	Resident / Non-Resident / Both	Thailand	
				✓=Yes X=No	
4	Transparency				
a)	Disclosure of government bond issuance calendar	Reg	Both	✓	A yearly plan is announced following a dialogue between BOT, MOF, ThaiBMA, PDs and investors. Quarterly schedule is announced two Fridays before the beginning of each quarter.
b)	Regular data on holdings by investor class, i.e. banks, insurance/pension funds, foreigners, retail	Reg	Both	✓	monthly basis (only on government bonds) quarterly basis (on corporate bonds) http://www.thaibma.or.th/CorpBondHolder_report/CorpBondHolderPage.aspx
c)	Availability of benchmarks at regular intervals	Mkt Dev	Both	✓	Regular benchmark bond tenor (5/10/15/20/30 years) is offered every other month
d)	Inclusion in an internationally accepted bond index	Mkt Dev	Both	✓	iBoxx ABF Thailand Index (International Index Company Limited: IIC)
5	Funding / Hedging Instruments				
a)	Availability of active repo / securities borrowing and lending market	Mkt Dev	Both	✓	
ai)	Term ≤ 2 weeks	Mkt Dev	Both	✓	
aii)	Term ≥ 2 weeks	Mkt Dev	Both	✓	
aiii)	PD to PD activity (Onshore interbank)	Mkt Dev	Both	✓	
aiv)	PD to non-PD allowed	Mkt Dev	Both	✓	
av)	Bank to non-bank (i.e. end user customer) allowed	Mkt Dev	Both	✓	
avi)	Use of Global Master Repo Agreement	Mkt Dev	Both	✓	
b)	Availability of active interest rate swap market	Mkt Dev	Both	✓	(up to 5 years maturity)
bi)	Use of ISDA Master Agreement	Mkt Dev	Both	✓	
c)	Availability of active futures market	Mkt Dev	Both	✓	Trading Interest Rate Future by end of 2010
ci)	Government bond futures	Mkt Dev	Both	✓	5Y Gov Bond Futures (18 Oct 2010)
cii)	Short-term Interest rate futures	Mkt Dev	Both	✓	3M BIBOR Futures & 6M THBFIX Futures (Nov 29, 2010)
d)	Suitably wide range of securities eligible for central bank liquidity	Reg	Resi	✓	
di)	Inclusion of government-guaranteed LCY bonds under permitted instruments for the central bank repo facility	Reg	Resi	✓	
dii)	Inclusion of government-guaranteed LCY bonds under local statutory reserve requirements	Reg	Resi	✓	
diii)	Incorporation into reserve ratios/ creation of separate regulatory reserve ratio(s) for government-guaranteed LCY bonds	Reg	Resi	✓	
div)	Incorporation into reserve ratios/ creation of separate regulatory reserve ratio(s) for supranational bonds	Reg	Resi	✓	Accepted only in emergency case
6	Tax Treatment				
a)	Exemption from withholding tax	Reg	Both	X	
ai)	Exemption from withholding tax on government bonds - resident	Reg	Resi	X	

continued on next page

Table A1.1 continuation

	ASEAN Bond Market Development Scorecard	Regulatory / Market Development	Resident / Non-Resident / Both	Thailand	
				✓=Yes X=No	
a ii)	Exemption from withholding tax on government bonds - non-resident	Reg	Non-resi	X	
a iii)	Exemption from withholding tax on corporate bonds - resident	Reg	Resi	X	
a iv)	Exemption from withholding tax on corporate bonds- non-resident	Reg	Non-resi	X	
7	Settlement and Custody				
a)	Use of SWIFT as standardized message format	Mkt Dev	Both	✓	
b)	Use of ISIN securities numbering scheme	Mkt Dev	Both	✓	
c)	DvP - Use of electronic trade-matching	Mkt Dev	Both	✓	
d)	DvP - Use of settlement pre-matching	Mkt Dev	Both	✓	
e)	DvP - Effective depository links for cross-border settlement and custody	Mkt Dev	Both	X	
<p>^a Thai BMA. Footnote 3. http://www.thaibma.or.th/CorpBondHolder_report/CorpBondHolderPage.aspx</p> <p>Notes: ✓ = Yes X = No</p> <p>ASEAN = Association of Southeast Asian Nations; BIBOR = Bangkok Interbank Offered Rate; BOT = Bank of Thailand; DvP = delivery versus payment; IFRS = International Financial Reporting Standards; ISDA = International Swaps and Derivatives Association; ISIN = International Securities Identification Number; LCY = local currency; MOF = Ministry of Finance MTN = medium-term notes; NR = non-resident; PD = primary dealer; SEC = Securities and Exchange Commission of Thailand; SWIFT = Society for Worldwide Interbank Financial Telecommunication; ThaiBMA = Thai Bond Market Association Source: Securities and Exchange Commission Thailand.</p>					

Appendix 3. ASEAN Bond Market Development Scorecard: ASEAN

Table A1.2 ASEAN Bond Market Development Scorecard: ASEAN

	ASEAN Bond Market Development Scorecard	Regulatory / Market Development	Resident / Non-Resident / Both	Brunei Darussalam	Cambodia	Indonesia	Lao PDR	Malaysia	Myanmar	Philippines	Singapore	Thailand	Viet Nam
A	ISSUER												
1	Market Access												
a)	Acceptance of MTN programmes	Reg	Both	X	X	✓	X	✓	X	✓	✓	✓	✓
ai)	International MTN programmes	Reg	Both	X	X	✓	X	✓	X	✓	✓	X	X
aii)	Local MTN programmes	Reg	Both	X	X	✓	X	✓	✓	✓	✓	✓	✓
b)	Removal of discriminatory restrictions on issuance by non-residents	Reg	Non-resi	X	X	X	X	✓	X	✓	✓	✓	X
2	Transparency												
a)	Disclosure standards - Adoption of ASEAN and Plus Standards	Reg	Both	X	X	X	X	✓	X	X	✓	✓	X
ai)	Accounting standards - Adoption of IFRS for cross-border offerings	Reg	Both	X	X	X	X	✓	✓	✓	✓	✓	X
aii)	Auditing standards - Adoption of ISA for cross-border offerings	Reg	Both	X	X	X	X	✓	✓	✓	✓	✓	X
B	INVESTOR												
3	Market Access												
a)	Non-resident market access	Reg	Non-resi	X	X	✓	X	✓	X	✓	✓	✓	✓
ai)	Elimination of investor registration requirements	Reg	Non-resi	X	X	X	X	✓	X	✓	✓	✓	✓
aii)	Removal of discriminatory restrictions on investment by non-resident investors	Reg	Non-resi	X	X	X	X	✓	X	✓	✓	✓	✓
aiii)	Removal of discriminatory restrictions on non-resident institutional investors' portfolio composition	Reg	Non-resi	X	X	X	X	✓	X	✓	✓	✓	✓
aiv)	Removal of restrictions on non-resident LCY borrowing (i.e. intraday credit/overnight credit, etc.)	Reg	Non-resi	X	X	X	X	X	X	X	✓	X	X
b)	Removal of investment restrictions on resident investors	Reg	Resi	X	X	✓	X	✓	✓	✓	✓	✓	✓
c)	Existence of clear legislation on bond holders' rights	Reg	Both	X	X	✓	X	✓	✓	✓	✓	✓	✓
4	Transparency												
a)	Disclosure of government bond issuance calendar	Reg	Both	✓	X	✓	✓	✓	✓	✓	✓	✓	✓
b)	Regular data on holdings by investor class, i.e. banks, insurance/pension funds, foreigners, retail	Reg	Both	✓	X	✓	✓	✓	✓	✓	X	✓	X
c)	Availability of benchmarks at regular intervals	Mkt Dev	Both	X	X	✓	X	✓	X	✓	✓	✓	X
d)	Inclusion in an internationally accepted bond index	Mkt Dev	Both	X	X	✓	X	✓	X	✓	✓	✓	X

continued on next page

Table A1.2 continuation

	ASEAN Bond Market Development Scorecard	Regulatory / Market Development	Resident / Non-Resident / Both	Brunei Darussalam	Cambodia	Indonesia	Lao PDR	Malaysia	Myanmar	Philippines	Singapore	Thailand	Viet Nam
5	Funding / Hedging Instruments												
a)	Availability of active repo / securities borrowing and lending market	Mkt Dev	Both	X	X	✓	✓	✓	X		✓	✓	X
ai)	Term ≤ 2 weeks	Mkt Dev	Both	✓	X	✓	✓	✓	X	✓	✓	✓	X
aii)	Term ≥ 2 weeks	Mkt Dev	Both	✓	✓	✓	X	✓	X	✓	✓	✓	X
aiii)	PD to PD activity (Onshore interbank)	Mkt Dev	Both	✓	✓	✓	X	✓		✓	✓	✓	✓
aiv)	PD to non-PD allowed	Mkt Dev	Both	✓	✓	✓	X	✓		✓	✓	✓	✓
av)	Bank to non-bank (i.e. end user customer) allowed	Mkt Dev	Both	✓	✓	✓	✓	✓	X	✓	✓	✓	✓
avi)	Use of Global Master Repo Agreement	Mkt Dev	Both	X	X	X	X	✓	✓	✓	✓	✓	X
b)	Availability of active interest rate swap market	Mkt Dev	Both	X	X	✓	X	✓			✓	✓	X
bi)	Use of ISDA Master Agreement	Mkt Dev	Both	X	X	X	X	✓	✓	✓	✓	✓	X
c)	Availability of active futures market	Mkt Dev	Both	X	X		X	X			X	✓	X
ci)	Government bond futures	Mkt Dev	Both	X	X		X	X	✓	X	X	✓	X
cii)	Short-term Interest rate futures	Mkt Dev	Both	X	X		X	X	✓	X	X	✓	X
d)	Suitably wide range of securities eligible for central bank liquidity	Reg	Resi	X	✓	X	X	✓	✓		✓	✓	✓
di)	Inclusion of government-guaranteed LCY bonds under permitted instruments for the central bank repo facility	Reg	Resi	X	✓	X	X	✓	✓	✓	✓	✓	✓
dii)	Inclusion of government-guaranteed LCY bonds under local statutory reserve requirements	Reg	Resi	X	X	X	✓	✓	✓	✓	✓	✓	✓
diii)	Incorporation into reserve ratios/creation of separate regulatory reserve ratio(s) for government-guaranteed LCY bonds	Reg	Resi	X	X	X	✓	✓	✓	X	✓	✓	✓
div)	Incorporation into reserve ratios/creation of separate regulatory reserve ratio(s) for supranational bonds	Reg	Resi	X	X	X	X	✓		X	✓	✓	✓
6	Tax Treatment												
a)	Exemption from withholding tax	Reg	Both		X		✓	X	✓	X	✓	X	X
ai)	Exemption from withholding tax on government bonds - resident	Reg	Resi	X	X		✓	X		X	✓	X	X
aii)	Exemption from withholding tax on government bonds - non-resident	Reg	Non-resi	✓	X		✓	✓		X	✓	X	X
aiii)	Exemption from withholding tax on corporate bonds - resident	Reg	Resi	X	X		✓	X		X	✓	X	X
aiv)	Exemption from withholding tax on corporate bonds- non-resident	Reg	Non-resi	Partial	X		✓	✓		X	✓	X	X
7	Settlement and Custody												
a)	Use of SWIFT as standardized message format	Mkt Dev	Both	X	X	Partial	✓	✓	✓	✓	✓	✓	✓
b)	Use of ISIN securities numbering scheme	Mkt Dev	Both	X	X	Partial	X	✓	✓	✓	✓	✓	✓
c)	DvP - Use of electronic trade-matching	Mkt Dev	Both	X	X	✓	X	X		✓	✓	✓	✓
d)	DvP - Use of settlement pre-matching	Mkt Dev	Both	X	X	✓	X	✓		✓	✓	✓	X
e)	DvP - Effective depository links for cross-border settlement and custody	Mkt Dev	Both	✓	X	X	X	✓		✓	✓	X	X
Notes: ✓ = Yes X = No Source: <Please indicate source>.													

Appendix 4. Scorecard-Related Explanation

Scorecard Explanation

Extract from “the Joint Media Statement of the 14th ASEAN Finance Ministers’ Meeting (AFMM)”

Nha Trang, Viet Nam, 8 April 2010

Capital Market Development and Integration

9. Strong, efficient and liquid capital markets are important in attracting more investment to the region, facilitating greater inter-regional trade flows, and ensuring ASEAN’s long-term competitiveness. To further develop our bond markets, we endorsed the formation of a set of “bond market development” indicators, which will serve as benchmark reference points to measure the state of ASEAN’s bond market development, and as a **scorecard** to identify key priorities for bond market integration and development in ASEAN. Recognizing the varying levels of bond market development across the region, we agreed for targeted capacity building initiatives to collectively enhance liquidity and efficiency in our capital markets. At the same time, promoting ASEAN as an asset class remains an important task. We will therefore step up our investor outreach efforts to deepen and broaden the investor base in the region.

10. We have also made substantial progress in integrating our capital markets to enhance our competitiveness in the global arena. Work is underway to create brand recognition for ASEAN products, lift standards of regulations, build mutual and global trust in ASEAN standards through mutual recognition regimes, and facilitate flow and access into our markets. The “ASEAN and Plus Standards” for multi-jurisdictional offerings of securities have been adopted in Malaysia, Singapore and Thailand. We will promote dual listing of securities and cross-border offerings of debt securities and collective investment schemes. We are encouraged by the progress made towards the establishment of ASEAN exchange linkages. We welcome the initiative to develop mutual recognition framework for capital market professionals across the region. Through the tax authorities, we will explore ways to address withholding tax issues affecting regional capital market development.

The ASEAN and Plus Standards Scheme⁴⁶

Introduction

The ASEAN and Plus Standards Scheme was developed by the ASEAN Capital Markets Forum (ACMF) to facilitate cross-border offerings of securities within the ASEAN region.

⁴⁶ Association of Southeast Asian Nations. <http://www.asean.org/22674.pdf>

The Scheme brings ease and cost savings to issuers who make offerings of securities across borders within ASEAN.

The Scheme therefore enhances the attractiveness of ASEAN as a combined capital market for fund-raising, as well as underlines the combined ASEAN securities as an attractive asset class by raising the disclosure standards among ASEAN members to international level.

Scope of the ASEAN and Plus Standards Scheme

The ASEAN and Plus Standards Scheme will apply:

1. To multi-jurisdiction offerings within ASEAN of plain equity and debt securities that require the registration of prospectuses or registration statements.
2. To all issuers, ASEAN and non-ASEAN alike, making such offerings within ASEAN.

The ASEAN and Plus Standards Scheme (the Scheme)

The Scheme introduces two levels of Standards, comprising a set of common ASEAN Standards, and a set of limited additional standards known as the Plus Standards.

1. **The ASEAN Standards** are based on the standards on cross-border offerings set by the International Organization of Securities Commissions (IOSCO). However, the ASEAN Standards do exceed some of the dated IOSCO standards where appropriate. They also fully adopt the accounting and auditing standards of the International Financial Reporting Standards (IFRS) and International Standards on Auditing (ISA).
2. **The Plus Standards** contain additional standards that are required by some ASEAN jurisdictions due to their individual market practices, laws or regulations.

The ASEAN and Plus Standards' Documents

The following documents are details of the ASEAN Standards as well as the details of the distribution timelines.

Equity Securities	Debt Securities
1. ASEAN EQUITY SECURITIES DISCLOSURE STANDARDS http://www.asean.org/22674-1.pdf	1. ASEAN DEBT SECURITIES DISCLOSURE STANDARDS http://www.asean.org/22674-2.pdf
	2. LIST OF SUPPORTING DOCUMENTS REQUIRED BY EACH JURISDICTION Issuer is required to submit the following documents to regulator in host jurisdiction when seeking the approval/registration. http://www.asean.org/22674-3.pdf

Questions and answers regarding the ASEAN Standards Scheme can be found in the FAQs.

1. Who will benefit from this ASEAN and Plus Standards Scheme?

The Scheme will benefit both ASEAN and non-ASEAN issuers who make multi-jurisdiction offerings of plain equity and debt securities within ASEAN which require the registration of disclosure documents. It will be easier for these issuers as they can comply with one common set of ASEAN Standards in their preparations of disclosure documents, together with some additional requirements set forth in the Plus Standards. This is in contrast to the current practices where issuers have to separately comply with each jurisdiction's disclosure requirements if they seek to do multi-jurisdiction offerings.

2. Do issuers have to comply with other requirements in order to make multi-jurisdiction offerings of securities in ASEAN? This will depend on each individual ASEAN members' regulatory framework because the cross-border offerings under this Scheme are still subject to regulatory approval of the host jurisdictions where the securities are offered. However, having this Scheme in place, the issuers will benefit from the ability to issue one set of disclosure documents together with some wrap-around for additional requirements (prescribed under the Plus Standards) to investors. Issuers who are interested in this Scheme are encouraged to consult with respective securities regulators or the ACMF Secretariat at strategy@sec.or.th

3. Why is it necessary to have the Plus Standards? The Plus Standards are in place to comply with specific requirements in the market practices, laws or regulations of each jurisdiction. However, the ACMF has agreed to reduce the number of Plus Standards, in periodic reviews, to achieve greater harmonization in order to provide maximum benefits to issuers.

4. Which IOSCO Disclosure Standards are the ASEAN Standards benchmarked against? The ASEAN Standards are benchmarked against the following IOSCO Standards:

- 1) IOSCO International Disclosure Standards for Cross-Border Offerings and Initial Listings by Foreign Issuers (1998) on which the ASEAN Standards for the offerings of equity securities are based, and
 - 2) IOSCO International Disclosure Standards for Cross-border Offerings and Listings of Debt Securities by Foreign Issuers (2007) on which the ASEAN Standards for the offerings of debt securities are based.
- Both documents are available on the IOSCO's web site www.iosco.org

The Implementation of the Scheme Since the development of the Scheme, the ACMF agreed that the timeframe for the adoption of the ASEAN Standards by ACMF members would depend on the readiness of each member on an opt-in basis.

On June 12, 2009, the Securities Commission, Malaysia, the Monetary Authority of Singapore and the Securities and Exchange Commission, Thailand, announced, through a press release, that they have implemented the ASEAN and Plus Standards Scheme. The joint press release and the FAQs can be found here.

<http://www.asean.org/22674-4.pdf>

FREQUENTLY ASKED QUESTIONS ASEAN and Plus Standards Scheme

1. What is the ASEAN and Plus Standards Scheme? The ASEAN and Plus Standards Scheme was developed as part of a harmonisation initiative by the ASEAN Capital Markets Forum (ACMF) to facilitate cross-border offerings of securities within the ASEAN region.

The Scheme introduces two levels of standards, comprising a set of common ASEAN Standards, and a set of limited additional standards known as the Plus Standards. The ASEAN Standards are a set of common standards governing disclosures for plain (*1) equity and debt offerings and are based on standards on cross-border offerings set by the International Organization of Securities Commissions (IOSCO). The Plus Standards are the respective additional standards that may be prescribed by the individual ASEAN jurisdictions where harmonisation is not yet possible due to their individual market practices, laws or regulations. Further details of the Scheme are available on:

<http://www.aseansec.org/acmf/introduction.htm>

continued on next page

FAQ ASEAN continuation

2. What is the purpose of having the ASEAN and Plus Standards Scheme? The Scheme will benefit ASEAN and non-ASEAN issuers who make multi-jurisdiction offerings of plain equity and debt securities within ASEAN by increasing efficiency and reducing costs. Under the Scheme, when an issuer wishes to make a multi-jurisdiction offer of securities, the issuer needs to provide only a common set of disclosure documents based on the ASEAN Standards, together with the appropriate wrap-around for the Plus Standards, to investors in each jurisdiction. For example, Malaysian issuers who undertake cross-border offerings in Singapore and Thailand would be required to provide a set of disclosure documents based on the ASEAN Standards to the investors in Singapore and Thailand, along with the wrap-around based on the Plus Standards of Singapore and Thailand.

3. Have all member countries of ASEAN implemented the ASEAN and Plus Standards Scheme? The timeframe for the implementation of the Scheme depends on the readiness of each ASEAN member on an opt-in basis. As at 12 June 2009, Singapore, Thailand and Malaysia have announced the implementation of the Scheme under their respective jurisdictions.

4. I would like to undertake a cross-border offering of securities in two jurisdictions that have implemented the ASEAN and Plus Standards Scheme. Is it sufficient that my prospectus comply with the disclosure requirements of the ASEAN Standards? In addition to complying with the ASEAN Standards, which are the same set of rules applied to jurisdictions who adopted the Scheme (at present Malaysia, Singapore and Thailand), the issuer must also comply with the Plus Standards of the respective jurisdictions, and the prospectus registration procedures of these jurisdictions. The issuance of securities may also be subject to other requirements from each jurisdiction. In this regard, the issuer would need to refer to the regulations and guidelines from the respective jurisdictions concerned.

5. The requirements of the Plus Standards in Country A are different from those in Country B. With which should my prospectus for a cross-border offering of securities comply? Your prospectus must comply with all the disclosure requirements stipulated by each member country. If the standards differ on a particular item, the general rule is that the stricter requirement should apply. If different requirements apply on the same issue, the prospectus should comply with both requirements.

6. Will ACMF members eventually reduce the number of their respective Plus Standards? Members of the ACMF have agreed to work towards reducing the number of Plus Standards over time so as to maximise the benefits of the ASEAN and Plus Standards Scheme to issuers. As such, it is envisaged that the ASEAN and Plus Standards Scheme will evolve and progress towards greater overall convergence of the disclosure standards in participating ASEAN jurisdictions.

(*1) The Scheme will apply to offers of shares and plain-vanilla debt securities only. It will not apply to: (i) Options, warrants or any other rights or interests in shares or debt securities; or (ii) Debt securities that are not plain-vanilla.

References

- Market Profile provided by Citibank
- Deutsche Bank AG Domestic Custody Services, Market Guide
- 2010 – THE GUIDE TO CUSTODY IN WORLD MARKETS by State Street
- asianbondsonline.adb.org

Prof. Shigehito Inukai
Faculty of Law, Waseda University
1-6-1, Nishiwaseda, Shinjuku-ku, Tokyo, 〒169-8050
Tel & Fax (Direct): + 81-(0)3-3202-2472
Mobile: +81-(0)80-3360-7551
E-Mail: shige.inukai@me.com

Viet Nam

Bond Market Guide

Contents

Acknowledgement	vii
I. Structure, Type, and Characteristics of the Market	1
A. Overview of the Viet Nam Domestic Bond Market	1
B. Types of Bonds	3
C. Methods of Issuance and Settlement of Bonds	8
D. Credit Rating Agencies and Credit Rating of Bonds	9
E. Corporate Bond-Related Systems for Investor Protection (Disclosure Rules)	9
F. Governing Laws on Bond Issuance	11
G. Transfer of Interests in Bonds	13
H. Definition of Securities	14
I. Self-Governing Rules behind the Market	15
J. Bankruptcy Procedures	18
K. Meetings of Bondholders	19
L. Event of Default	19
M. Parties Involved in Bond Issuance and Their Respective Roles	19
II. Primary and Secondary Markets Regulatory Framework	22
A. Viet Nam Market Regulatory Structure	22
B. Important Legislations and Regulations in the Viet Nam Bond Market	26
C. Substantial Shareholder Reporting Requirements	30
D. Rules and Regulations related to Buying Debt Instruments (Investment in Debt Securities)	31
E. Investor Protection	31
F. Capital Contribution Account Report	32
G. Securities Identification System	33
H. Taxation Framework and Tax Requirements	33
I. Tax Exemption Requirements for Non-Residents	34
J. Definition of Professional Investors in the Viet Nam Market	34
III. Trading of Bonds and Trading Market Infrastructure	35
A. Over-the-Counter Market Trading System of Bonds in Viet Nam	35
B. The Viet Nam Government Bond Market	37
C. Bond Repurchase Market	38
D. Viet Nam Bond Transaction Flow for Foreign Investors	38

IV. Possible Impediments and Restrictions	40
A. Lack of Liquidity in the Secondary Market	40
B. Increase in Market's Listing Scale	40
C. Imbalance in Bond Terms	40
D. Repo Market	40
E. Securities Lending	41
F. Lack of Regulation Related to Private Placement Market	41
G. Market Entrance Requirements	41
V. Description of the Securities Settlement System.....	42
A. Securities Settlement Infrastructure	42
B. Settlement Cycle	44
C. Settlement Method.....	44
D. Definition of Clearing and Settlement	44
VI. Cost and Charging Methods.....	46
VII. Market Size and Statistics	48
A. Size of Local Currency Bond Market in US Dollars (Local Sources)	48
B. Size of Local Currency Bond Market in Percentage of Gross Domestic Product (Local Sources)	49
C. Foreign Currency Bonds (Bank of International Settlement).....	50
D. Foreign Currency Bonds to Gross Domestic Product Ratio	51
E. FCY Bonds Outstanding (Local Sources).....	52
F. Issuance Volume of Local Currency Bond Market in US Dollars	53
VIII. Presence of an Islamic Finance (Islamic Bond [<i>Sukuk</i>] Market)	55
IX. History of Capital Market Development	56
X. Items for Future Improvement	73
XI. Next Steps ⇨ Future Direction	74
A. Future Direction: Viet Nam's Capital Market Outlook to 2020.....	74
B. Group of 30 Compliance.....	74
C. Group of Experts Final Report: Summary of Barriers and Market Assessment – Viet Nam (April/2010)	75
Appendix.....	77
References	80

Box, Figures, and Tables

Box

Box 2.1	Extracts from the Securities Law 2006 on Public Offers.....	27
---------	-------------------------------------------------------------	----

Figures

Figure 1.1	Plan to Develop the Viet Nam Bond Market	17
Figure 2.1	Viet Nam Market Regulatory Structure.....	22
Figure 3.1	Over-the-Counter Market Transaction from a Global Custodian's Point of View	35
Figure 3.2.	Trading Environment for Government Bonds and T-bills on HNX	37
Figure 3.3	Bond Transaction Flow for Foreign Investors	38
Figure 5.1	Securities Settlement Infrastructure in Viet Nam.....	42
Figure 5.2	Business Process Flow Chart of the Government Bond Market (Delivery versus Payment).....	43

Tables

Table 2.2	Duties and Taxes.....	33
Table 6.1	Fees in the Viet Nam Bond Market.....	46
Table 6.2	New Fees Schedule.....	46
Table 6.3	Fees Schedule according to Classification.....	47
Table 7.1	Size of Local Currency Bond Market (Local Sources) (\$ billion)	48
Table 7.2	Size of Local Currency Bond Market (Local Sources) (\$ billion, % GDP).....	49
Table 7.3	Foreign Currency Bonds (BIS) (\$ billion).....	50
Table 7.4	Foreign Currency Bonds to GDP Ratio (\$ billion)	51
Table 7.5	Foreign Currency Bonds Outstanding (Local Sources) (\$ billion).....	52
Table 7.6	Issuance Volume of Local Currency Bond Market (\$ billion)	53
Table 9.1	Evolution of Capital Market Regulatory Framework in Viet Nam.....	56
Table 11.1	Group of Thirty Compliance	74
Table 11.2	Group of Experts Final Report on Viet Nam.....	75
Table A1.1	Decision on Approval of the Project for the Development of Vietnam's Capital Market up to 2010 and Outlook to 2020	77

Acknowledgement

The Asian Development Bank (ADB) Team, comprising Satoru Yamadera (Economist, ADB Office of Regional Economic Integration, - Sept. 2011), Seung Jae Lee (Principal Financial Sector Specialist), Shinji Kawai (Senior Financial Sector Specialist, Banking), Shigehito Inukai (ADB consultant), Taiji Inui (ADB consultant), and Matthias Schmidt (ADB consultant), would like to express their sincere gratitude to National Member Vietnam Bond Market Association (VBMA) and National Member Hanoi Stock Exchange (HNX), who kindly provided answers to the questionnaires prepared by the ADB Team, thoroughly reviewed the draft of the market guide, and gave their valuable comments.

The ADB Team would also like to express special thanks to Citibank; Deutsche Bank AG; HongKong Shanghai Banking Corporation (HSBC); J.P. Morgan and State Street for their contributions as International Experts in providing information from their respective market guides. Because of their cooperation and contribution, the ADB Team started the research on solid ground.

Last but not least, the Team would like to thank all the interviewees who gave their comments and responses to questions during the market consultations.

It should be noted that no part of this report represents the official views and opinion of any institution which participated in this activity as ASEAN+3 Bond Market Forum members and experts. The ADB Team bears responsibility for the contents of this report.

February 2012

Asian Development Bank (ADB) Team

List of Interviewees:

Ho Chi Minh City, 16 May 2011

Allen Arthur Robinson

HSBC, Ho Chi Minh City Branch

Deutsche Bank AG, Ho Chi Minh City Branch

Vietnam Bond Market Association (VBMA)

Ha Noi, 17 May 2011

State Bank of Vietnam (SBV)

State Securities Commission (SSC)

Citibank Hanoi

Vietnam Securities Depository (VSD)

Standard Chartered Bank Hanoi

I. Structure, Type, and Characteristics of the Market

A. Overview of the Viet Nam Domestic Bond Market

When the Viet Nam securities market started in 2000, government bonds were the only major products to be listed for trading on the market. Before 2006, government bonds were issued via auction at both the Hanoi Securities Trading Center (HASTC) and the Hochiminh Securities Trading Center (HOSTC); the former changed its name to Hanoi Stock Exchange (HNX) in 2009, the latter changed its name to Ho Chi Minh Stock Exchange (HOSE) in 2007. Since 2006, in accordance with *Decision No. 2276/QD-BTC* of the Ministry of Finance (MOF) on the centralization of government bonds bidding, all government bond issuance via auction has been exclusively conducted by HASTC/HNX. Prior to 2009, government bonds were allowed to be listed and traded on both HOSE and HNX. In September 2009, government bonds are exclusively listed and traded on HNX. This change was made in accordance with *Decision No. 86/QD-BTC* on the approval of the “Plan on Building a Specialized Government Bond Market,” wherein HNX was assigned as the only organizer of the secondary market for government bonds of Viet Nam. In addition to auction, government bonds are also issued via underwriting conducted by issuers themselves. Before 2010, government bonds are issued by two agencies, namely the State Treasury and the Vietnam Development Bank (VDB). However, from 2010 onwards, only the State Treasury is authorized by the government to carry out government bond issuance. In addition, the Vietnam Development Bank (VDB) and two other institutions, namely the Vietnam Bank for Social Policy (VBSP) and the Vietnam Expressway Corporation (VEC) are significant issuers of quasi-government bonds, or government-guaranteed bonds.

In September 2009, HNX established an electronic bond-trading system for government bonds. The operation of the new system was built completely separate from the bond market, with a transaction model suitable for the government bond market in Viet Nam. The new trading platform releases basic bond-related information such as issuers, members, prices, schedules, and settlement. It allows the identification of repurchased (repo) trades for the first time. This helped enhance transparency and increase liquidity in the bond market. Under the new system, the Treasury gives the exchange early notice on plans for capital mobilization, and

releases, quarterly and annual reports. Transactions take place from 8:30 a.m. to 11:00 a.m. local time. Securities companies and commercial banks are also able to trade directly on the new platform, with bonds being deposited at the Vietnam Securities Depository (VSD).

In recent years, Viet Nam's bond market has improved significantly as the government continues to initiate reforms and pass enabling legislation. Local government bonds—both in Viet Nam dong and US dollar—are issued in large lots while streamlined procedures continue to ease corporate bond issuance.

Government and government-guaranteed bonds issued by VDB, VBSP and VEC bonds hold a big share of the domestic debt market of Viet Nam, making up more than 90% of the market, followed by municipal and corporate bonds. Government bonds are commonly issued with tenors of 3 and 5 years. Other maturities such as 1, 2, 7, 15 years are available but each accounts for a small percentage in the whole government bond portfolio. Convertible bonds, all of which are corporate bonds, have also been introduced.

Bonds are typically purchased at initial auctions by insurance companies, banks, and individuals, and are held until maturity. In the absence of mutual funds and pension funds, banks play the role of market participants.

Government bonds are issued through both auction and underwriting while corporate bonds are mainly issued via underwriting. Government-guaranteed bonds issued by VDB, VBSP and VEC are required to be issued via the auction method on the Hanoi Stock Exchange. A number of licensed securities companies are authorized to provide brokering and agency services for the government bond market, as well as a full range of securities services including underwriting, brokerage, advisory, portfolio management, and trading in the corporate bond market.

To expand the equity side of the capital market without committing itself to outright privatization of state enterprises, the government has implemented “equitization”¹ of state-owned enterprises (SOEs). A number of SOEs plan to issue both local and international bonds.

In September 2003, the State Securities Commission (SSC) issued the “Capital Market Roadmap” with the development of the bond market as one of its key aims. There are three phases to the roadmap, which can be found in the Asian Development Bank website.²

The government's first international bond issuance in October 2005 was a resounding success. It also issued local bonds denominated in US dollars to attract domestic savings.

According to statistical data, there were 452 government bond issues trading on HNX by 31 December 2011, with the total listing value reaching VND285,242 billion.

¹ In this context, equitization means restructuring and initial public offering (IPO).

² Government of Viet Nam. State Securities Commission. 2003. *Viet Nam Capital Market Roadmap*. http://www.adb.org/Documents/Books/VIE_Capital_Market_Roadmap/

The year 2011 was recognized as the most successful year to date in terms of operating the government bond auction activities on HNX, with 130 auction sessions and a total mobilized value of VND81,715.8 billion, a three-fold increase over the year 2010.

The government bond trading system on HNX continues to run safely, with an average trading value of VND363,8 billion per trading session. Trading activities of foreign investors was strong, with the trading value reaching VND27,575.95 billion in 2011, accounting for 30.56% of the total trading value of the market.

After 2 years of operation, the government bond market member base has increased significantly number, from originally 25 members to now 93 members for both primary and secondary markets, comprising most of the financial institutions in Viet Nam, across commercial banks, securities companies, financial investment funds, insurance companies and other institutions. The stronger participation by government bond market members has improved the linkage between the government bond market and the capital market at large and the money market, stabilized the market interest and created greater stability for the macro-economy.

In order to provide a highly exact bond benchmark yield curve to the market which helps investors make better investment decisions in the bond market, HNX has upgraded its information and trading system, and has been building a Bond Benchmark Yield Curve. This curve will first be published in the 1st quarter of 2012.

B. Types of Bonds

1. By Issuer Category

a. Bonds Issued by Public Entities

Currently, there are three categories of long-term government instruments in the market: government bonds, government-guaranteed bonds, and municipal bonds. Treasury bills, on the other hand, are categorized as short-term instruments. Treasury bills are not traded on the local exchanges and are only available to commercial banks that maintain accounts with the State Bank of Vietnam (SBV). Treasury Bills are kept in SBV's custody accounts. All listed long-term fixed-income securities are immobilized at the VSD, traded on the exchanges, and transferred electronically. The settlement cycle is T+1.

i. Government Bonds

Government bonds are issued by the MOF through the State Treasury. Government bonds are issued in two methods—auction and underwriting—with auction as the dominant method compared with underwriting. All government bond auctions are conducted via the HNX. Proceeds from government bond issuance are used to finance public service-related projects such as energy, infrastructure and education projects, including the implementation of social welfare policies and monetary policies.

ii. Government-Guaranteed Bonds

Government-guaranteed bonds are bonds with a maturity of more than 1 year, issued by authorized entities to mobilize capital for investment projects as appointed by the Prime Minister. The main issuers include the VDB, Vietnam Bank for Social Policies, and Vietnam Express Corporation.

Before 2010, bonds issued by the VDB were also called government bonds; however, beginning 1 January 2010, these have been classified as government-guaranteed bonds.

iii. Municipal bonds

Municipal bonds are used for financing specific projects, and typically have a tenor of 1 year or more. The average size of municipal bonds is equivalent to USD10 million. There are only three known issuers: Ho Chi Minh City, Hanoi, and Dong Nai province. Issuance is subject to strict monitoring and approval by the central government. Ceiling rates are defined by MOF (ca 20-30 basis points [bps] over government bonds). Theoretically, these bonds can be held either as registered or bearer instruments denominated in Vietnamese dong, but most of them are scrippless.

All government bonds, government-guaranteed bonds and municipal bonds are listed on the HNX only, with an average size of equivalent to USD20 million. Approximately 90% of all bonds issued in Viet Nam are government bonds and are scrippless. Government bonds are dematerialized by book-entry system within the VSD and the exchange of the Vietnam Central Bank. All government-type bond trading is done via put-through and electronic matching on the HNX electronic bond system. Listing of bonds means the exchange is used for trade-matching purposes. At the same time, bond ownership transfers are not valid unless bond transactions are recorded on HNX's electronic bond system and settled at VSD.

Viet Nam successfully launched its maiden sovereign bond issue (denominated in US dollar) in October 2005, and USD1 billion sovereign-bond proceeds were used to finance key refinery, power, and cargo ship projects in September 2007. In February 2009, the government issued the first US dollar-denominated government bonds to domestic investors.

Beginning September 2009, all government bonds have been pooled and traded on the government bond system of the HNX. As of 31 December 2011, the total number of government bonds in Viet Nam was 452, with a total value of VND285,242 billion, which is equivalent to 11.4% of gross domestic product (GDP). Designed with two trading types—outright trading and repo trading—the government bond-trading system of HNX has been operated in a stable, secure manner that fulfills the needs of market participants. The total trading value in 2011 reached VND90,221.6 billion, with an average value of VND363.8 billion per session, which is equivalent to 98.2% of the total market trading value; the value of outright trading was VND88,628.68 billion and that of repo trading was VND1,592.91 billion, which is equivalent to 1.8% of the total market trading value. In 2011, foreign investors returned to trade actively in the government bond market. Bonds with remaining maturity of about 2 years were most frequently traded, accounting for 30% of total market trading values, followed by 3-year (22.6%), 1-year (17.8%), and 10-year maturity bonds (12%).

Access to HNX's electronic bond system is for members only. Non-members have to use the brokerage services of any of HNX's members. The number of market participants has been increasing as well. On the opening date on 24 September 2009, there were only 30 trading members. One year later, the market attracted 13 new members, which increased the total number of involved trading members to 43, with 26 securities companies and 17 foreign commercial banks. Two years later, the market has 93 members for both primary and secondary markets. Commercial banks have played an important role in creating secondary-market liquidity with their involvement in both the capital and monetary markets; commercial banks are building a bridge between these two markets.

Bond market information is distributed automatically to regulators, trading members and investors through the diversified information infrastructure of the HNX including *Infobonds*, websites, bulletins, and a network of HNX's information vendors. Besides, HNX carries out electronic storage and data accumulation from different sources to secure electronic data for the bond market. Pursuant to regulations, HNX has the official mandate to maintain a comprehensive database on government bonds. This database is used as the official source on the Viet Nam government bond market by regulators.

In the primary market, government bonds are issued through bidding and underwriting. All government-bonds bidding is done via the HNX while underwriting is conducted by the issuer itself (i.e., the State Treasury), which accounts for a small percentage of bond issuances since 2009. Bond bidding is compulsory for all government-guaranteed bonds and underwriting is not allowed for guaranteed bond issuance.

In 2011, HNX organized 130 bidding sessions with a total mobilized value of VND81,715.8 billion (a 3-fold increase compared to 2010, which was the most successful year in terms of operating bidding activities at HNX to date. Total bid placing volume by market participants (VND226,595 billion) was larger than government bid offer volume (VND193,550 billion). The bidding winning rate gained 42.2% on the total offering volume by issuing entities (a 10-fold increase compared with the year 2010). The significant milestone in bidding activities in 2010 was that HNX cooperated with the State Treasury to drastically boost bidding in big lots throughout the year, and had been carrying out the restructuring of the number of bonds in the market.

In terms of yields, secondary market information reflected financial market realities. Specifically, trading yields of 1-year, 2-year, 3-year bonds declined during the year 2010, which is consistent with the tendency of yields recorded in government bond auctions on the primary market of both government bond market and money market. Besides, the growth in trading showed that the government bond system initially had an impact on capital turnover channels among members. Thus, besides monetary market and open market operations (OMO), the government bond market supported members' liquidity, especially in tight liquidity situations. In 2011, trading yields of 1-year, 2-year, and 3-year bonds have increased compared with 2010. However, it is still lower than the commercial bank system's average mobilization interest rate, by around 190 basis points.

b. Bonds Issued by Private Entities

Under the new *Decree 52/2006*, joint-stock companies, SOEs being restructured into limited liability companies, and foreign-invested companies operating in Viet Nam would be eligible to issue bonds. The new decree stipulates that enterprises will be fully responsible for issuing bonds and making subsequent bond payments, and commit that capital raised from bonds will only be used for investment projects, resettlement of long- and medium-term loans, and raising operational capital. Bond issuances must also be executed in a transparent manner, guaranteeing the rights of investors. To be eligible, companies have to satisfy conditions of operating for at least 1 year, file an audited financial report demonstrating profitable operations in the previous year, and seek approval from relevant authorities for their issuance plan.

Corporate bonds are issued by companies and SOEs. These bonds can be held in bearer or registered form, and are normally categorized as unlisted bonds at the outset. Unlisted corporate bonds are registered and held in the form of securities booklets, and are generally put in bank vaults for safekeeping. In this case, banks also play the role of registrar. By fulfilling certain conditions, corporate bonds can be listed and traded on HNX and HOSE, depending on which exchange corporate bond issuers may choose to have their bonds listed. Listed corporate bonds are electronically transferred and settle on T+3, just like equity. Most corporate bonds listed on HNX have a face value of VND100,000, whereas unlisted corporate bonds, especially those of several large SOEs, can have a face value of VND1 billion. Common to both types of bonds is a tenor of 5 years or more. Convertible bonds were first issued in 2006 and denominated in Viet Nam dong. The corporate bond market has grown rapidly since 2009 due to improvement in the legal framework.

c. Money Market Instruments

The commonly available money market instruments apart from time deposits and Certificates of Deposit (CDs) are:

i. Treasury Bills

Treasury bills are issued by the State Treasury at tenors less than 1 year (normally 13 weeks, 26 weeks, and 52 weeks). These are discounted securities with a face value of VND100,000. This instrument is issued to temporarily finance the state's budget deficit or help the SBV in controlling monetary policy. These bills are issued in the form of book entry, currently kept in custody with the SBV, and are open-market instruments.

Viet Nam will have T-bills traded exclusively on HNX's electronic bond system by May 2012. This plan is envisaged to create a secondary market for T-bills.

ii. State Bank of Vietnam Bills

Up to now, there is only one issuance of SBV bills sold on 17 March 2008. Banks were required to buy VND20.3 trillion worth of bills, and were not allowed to trade them with the central bank, aiming to withdraw cash from the economy and actively control liquidity.

iii. Repos of Government Bonds

Repos were introduced in 2003. Government bonds (including T-Bills and government bonds with maturities of more than 1 year) are accepted as collateral for repos between commercial banks and SBV. Such repos are conducted on the open-monetary market.

Government bonds with maturities of more than 1 year are commonly used as collateral for repos between securities firms, commercial banks, and financial firms. Trading of these repos are done on HNX's bond system, mainly via the put-through method. Municipal bonds are legally acceptable as collaterals for repos; but in reality, they are rarely used.

2. By Listing Status

a. Exchange Listing

Government bonds (including Treasury bonds, government-guaranteed bonds, and municipal bonds) are automatically and exclusively listed and traded on the HNX. Corporate bonds can be listed on HNX or on HOSE, and corporate issuers are the ones to decide whether to list their bonds.

To be qualified for listing on any exchange, corporate issuers have to satisfy the listing requirements set out in the *Securities Law* and by-law documents. Under the *Securities Law*, listing is done to make securities eligible to be transacted at the stock exchanges. Listed bonds in Viet Nam generally mean that (1) they are traded on the exchange, (2) the securities are scripless (dematerialized by book-entry system), and (3) they are registered and settled at the VSD.

Transfer of ownership occurs simultaneously with settlement. Transactions in listed bonds can be negotiated outside the trading platforms of the exchanges. However, for the transfer of bond ownership to take place, these transactions must be put through the exchange's trading platform. As stipulated in the *Securities Law*, securities registration means the record of ownership and other rights of securities owners.

Government bonds (including Treasury-issued bonds, government-guaranteed bonds, and municipal bonds) are exclusively listed and traded on the HNX. The purposes of bond listing on the exchange are profiling, regulation, price discovery, and information gathering and dissemination.

b. Non-Listed and Over-the-Counter Traded Bonds

Corporate bonds are mainly non-listed.

Unlisted public companies' securities are immobilized by book-entry system within the VSD, and transfer of ownership occurs simultaneously with settlement. In this case, VSD is the registrar or the book-entry account holder.

Other non-listed bonds are registered and held in the form of securities booklets, and are generally put in bank vaults (local custodian) for safekeeping. In this case, banks play the role of a registrar.

c. Corporate Bond Transfer to the Hanoi Stock Exchange

Private companies and state-owned companies may transfer their bonds to the HNX for listing and trading upon fulfillment of the following listing criteria:

- (i) Has a minimum paid-in capital of VND10 billion;
- (ii) The issuing company needs to be a stock company, a limited liability company, or an SOE;
- (iii) Should have profitable business operations for 2 consecutive years prior to applying for listing; and
- (iv) Has a minimum of 50 bondholders.

3. By Note Forms

- a. Government bonds are scripless (dematerialized by book-entry system within the VSD).
- b. Corporate bonds may be in bearer form or registered form. Listed corporate bonds have to be deposited at the VSD to be eligible for trading on the exchanges.
- c. Global notes are not applicable in the Viet Nam market.

C. Methods of Issuance and Settlement of Bonds

Most bonds in Viet Nam are issued via auction and underwriting.

1. Government Debt

Government bonds have tenors of 2, 3, 5, 7, 10, or 15 years, and are issued by the MOF through the State Treasury and auctioned via HNX with a minimum par value of VND100,000. All government bonds are legally listed right after being issued and are in dematerialized form.

T-bills normally have tenors of 13, 26 and 52 weeks and are also issued by the MOF through the State Treasury. These are auctioned via the SBV and are in physical form.

The MOF limits T-bill purchases and trading to local or overseas Vietnamese organizations, or individuals and foreign organizations, or individuals working and living in Viet Nam. Therefore, foreign investors without a legal presence in Viet Nam are prohibited from trading T-bills.

While no secondary market for T-bills exists at present, the MOF has authorized HNX to create and operate an electronic platform for T-bills by May 2012. MOF expects this move to help create a secondary market for T-bills.

2. Corporate Debt

Corporate bonds are issued by corporations, bearer or registered form with a minimum par value of VND100,000 and a tenor of 1 year or more if they wish to be listed on the exchanges. Corporate bonds are normally in physical form until they are listed.

D. Credit Rating Agencies and Credit Rating of Bonds

Currently, there is no domestic credit rating agency in Viet Nam. Global rating agencies such as Standard & Poor's (S&P), Moody's Investor Service, Fitch Ratings, and Rating and Investment Information (R&I) have assigned credit ratings for Viet Nam. Viet Nam's first credit rating agency, Vietnamnet Credit Ratings Centre, opened in June 2005, but discontinued its operations after less than 1 year.

Rating selection involves information gathering, analysis, and monitoring of the financial health of an issuing entity. The rating methodologies and procedures for each rating agency can be found in the MOF website.³

E. Corporate Bond-Related Systems for Investor Protection (Disclosure Rules)

Issue authorization and disclosure duties for public offering of bonds are as follows:

After registration, actual (corporate) bond issues should obtain the SSC's authorization for issuance of bonds with a set of disclosure information.

1. Conditions for Offering Bonds to the Public

- a. The enterprise must have a paid-up charter capital at the time of registration for public offering of at least VND10 billion in book value.
- b. Being profit making in the year preceding the year of such registration for offering, it must have no accumulated losses up to the year of registration for offering or overdue debts of over 1 year.
- c. It must have a plan for offering and use and refund of capital received from the offering approved by the Board of Management, Board of Members, or the enterprise's owner.
- d. It must commit to fulfill obligations of the issuer towards investors, meet conditions for issuance and payment, and ensure investors' legitimate rights and interests, and other conditions.

2. Conditions for Offering Securities to the Public, Overseas, and Other Specific Cases

The government shall stipulate the conditions for offering securities to the public applicable to SOEs, foreign-invested enterprises (FIEs) that are transformed into joint stock companies, and newly established enterprises in the fields of infrastructure or high technology. It shall also set out the conditions for offering securities overseas and other specific cases.

3. Registration of Offering Securities to the Public

- a. The issuer offering securities to the public have to register with the SSC.
- b. The following cases are not subject to registration for offering securities to the public:
 - (i) Offering of bonds of the Vietnamese Government;

³ Government of Viet Nam. Ministry of Finance. http://www.mof.gov.vn/portal/page/portal/mof_en/Search%20detail?p_itemid=2736893&p_itemtype=2321838

- (ii) Offering of international financial institutions' bonds accepted by the Vietnamese Government;
- (iii) Offering of shares to the public by SOEs, which are transformed into joint stock companies; and
- (iv) The sale of securities upon a court judgment or decision, or the sale of securities by managers or persons entitled to assets in case of bankruptcy or insolvency.

4. Information prior to Public Securities Offering

At the time the SSC reviews the public securities offering registration dossier, the issuer, underwriter(s), and other relevant organizations and individuals may only use, in an honest and accurate manner, the information described in the prospectus submitted to the SSC to explore the market, provided that they clearly specify that the information on the date of issue and the securities selling price are the proposed information. Exploring the markets must not be conducted through the mass media.

5. Effectiveness of the Public Securities Offering Registration

- a. Within 30 days from the date of receipt of the valid dossier, the SSC shall examine and grant the Certificate for Public Securities Offering. In case of refusal, it must respond in writing and clarify the reasons thereof.
- b. The Certificate for Public Securities Offering granted by the SSC is a document certifying that the public securities offering registration dossier fully satisfies the conditions and procedures provided by law.
- c. Within 7 days from the date the Certificate for Public Securities Offering comes into effect, the issuer shall publish the Announcement of Offering in three consecutive issues of one electronic newspaper or written newspaper.
- d. The securities shall only be offered to the public after the announcement has been made, as stipulated in clause 3 of Article 20 of the *Law on Securities*.⁴

6. Distribution of Securities

- a. Distribution of securities shall only be conducted after the issuer ensures that securities buyers can access the prospectus in the public securities offering registration dossier announced at places mentioned in the Announcement of Offering.
- b. The issuer, underwriter, or issuing agency must distribute securities in a fair and public manner, and ensure that the time limit for registration of buying securities applicable to investors is at least 20 days. Such time limit shall be stipulated in the Announcement of Offering.
- c. In case the amount of securities registered to buy exceeds the amount of securities permitted to be issued, the issuer or the underwriter shall distribute the securities permitted to be issued to the investors in proportion with their purchase registration rate.
- d. The money paid for securities shall be transferred into a blocked bank account until the issue is completed and reported to the SSC.

⁴ Clause 3 of Article 20 of the *Law on Securities* states that, "within seven days after a certificate of public offering of securities becomes effective, the issuing organization shall publish an issuance announcement on an electronic or printed newspaper for three consecutive issues."

F. Governing Laws on Bond Issuance

The following are the regulations related to corporate bonds and government bonds.

1. Government Bonds

- a. *Circular No. 29/2004/TT-BTC* dated 6 April 2004 provides the guidelines on issuance underwriting and issuance agency for government bonds, government-guaranteed bonds, and municipal bonds.
- b. *Circular No. 21/2004/TT-BTC* issued by the MOF provides the guidelines on tenders of government bonds, government-guaranteed bonds, and municipal bonds via the centralized securities trading market.
- c. *Decision No. 46/2006/QD-BTC* provides the guidelines on the issuance of large lots of government bonds to strengthen capital mobilization, enhance the liquidity of government bonds, and help build a benchmark rate for debt instruments.
- d. *Circular No. 132/2010/TT-BTC* dated 7 September 2010 issued by the MOF provides the guidelines for the amendment and supplement to *Decision N. 46/2006/QD-BTC*.
- e. *Regulation No. 46/2008/QD-BTC* dated July 1, 2008 and issued by the MOF to provide rules for government bond trading management at the Hanoi Securities Trading Center (HaSTC, former name of HNX).
- f. *Circular No. 19/2004/TT-BTC* dated March 18, 2004 and issued by the MOF to provide guidelines for T-bill and foreign currency bond auctions via the State Bank of Vietnam.
- g. *Regulation No. 935/2004/QD-NHNN* dated July 23, 2004 and issued by the State Bank of Vietnam (SBV) to provide guidelines for T-bill and foreign currency bonds auctions via SBV.
- h. *Decree 01/2011/ND-CP* regulates the issuance of government bonds, government-guaranteed bonds, and municipal bonds. It took effect on 29 February 2011, and is expected to boost the development of Viet Nam's bond market.
- i. *Circular 17/2012/TT-BTC* dated February 8, 2012 issued by MOF provides guidelines for Government Bond Issuance in the domestic market.

Decree 01, which replaced *Decree 141*, is the legal basis to standardize activities in the primary government bond market. *Decree 01* contains many new provisions on the formation of a professional and effective bond market in accordance with standard international practices. This new decree includes significant changes such as linking government bonds issuance with public debt management under the new *Law on Public Debt Management*, which came into effect in 2010. The decree also unifies both foreign and local government bond issuance in a single decree instead of two, namely *Decree 141* and *Decree 53/2009/ND-CP* regarding the issuance of international bonds. In addition, the decree allows government bond issuance to be used to restructure debts and debt portfolios; it also allows bond swapping and buying back bonds before the due date. This step paves the way to restructure the currently small and fragmented bond market.

Another positive aspect of *Decree 01* is that it requires the MOF to gradually set up a market-maker system to raise bond market liquidity. Membership conditions are prescribed by the MOF and are outlined in the decree. Participants in bidding and bond underwriting practices specified in the decree will be considered and recognized as system members, provided they satisfy the said conditions.

The new decree provides clearer and stricter regulations regarding bond issuance and buying, which will allow for more effective control of capital usage for government bonds. While *Decree 141* restricted the use of capital from bond issuance to offset the budget deficit in the annual estimation approved by the National Assembly, *Decree 01* allows government bond issuance not only to compensate the temporary budget deficit and be used as budget expenditure for developing investment, but also to restructure government debts by lending to other organizations, and to ensure national financial security. As such, it will help issuers to use government bond capital more flexibly and effectively, and create conditions favorable to maintaining continuous and regular issuance to help develop the market.

2. Corporate Bonds

- a. *Securities Law 2006 No. 70/2006/QH11*⁵ is the highest regulatory document governing the listed and public corporate bond issuance and trading.

This law stipulates that an issuer who wishes to make a public offering of bonds must prepare certain documents and follow disclosure requirements, prior to a formal approval by the SSC. It stipulates the issuer's responsibilities to maintain a healthy financial condition to meet its financial obligations to bondholders. This law clearly mentions disclosure rules and practices for issuers.

Viet Nam's National Assembly passed a law amending the 2006 Law on Securities (known as the Amended Law), and became effective on 01 July 2011. The Amended Law revisits a number of issues on securities, securities business and the securities market. For further explanation, visit the following Freshfields Bruckhaus Deringer website.⁶ To access the Amended Law itself, visit the following Legal Normative Documents, Ministry of Justice website.⁷

- b. *Enterprise Law 2005 No. 60/2005/QH11* facilitates the means for issuing debt for a shareholding firm by stating their rights to issue corporate bonds, convertible bonds, and other types of bonds.⁸

The law prohibits enterprises from issuing bonds when they do not exhibit a sound financial position, having indications of either low debt-servicing capability or below-average profitability. More specifically, a company is not allowed to issue bonds if:

- (i) It fails to make full repayment for the principal and interest of issued bonds, or do not pay or make full payment of due debts in the last 3 consecutive years.
- (ii) Its average after-tax-profit rate in the last 3 consecutive years is not higher than the interest proposed to pay for bonds to be issued.

⁵ Government of the Socialist Republic of Viet Nam. 2006. *Law on Securities (70/2006/QH11)*. Legal Normative Documents, Ministry of Justice website. http://moj.gov.vn/vbpq/en/Lists/Vn%20bn%20php%20lut/View_Detail.aspx?ItemID=4745

⁶ Freshfields Bruckhaus Deringer website. <http://www.freshfields.com/publications/pdfs/2011/mar11/30008.pdf>

⁷ Ministry of Justice. http://moj.gov.vn/vbpq/en/Lists/Vn%20bn%20php%20lut/View_Detail.aspx?ItemID=10492

⁸ Government of the Socialist Republic of Viet Nam. 2005. *Enterprise Law (60/2005/QH11)*. <http://www.vietnamlaws.com/freelaws/Lw60na29Nov05Enterprises%5B10Apr06%5D.pdf>

- c. Law amending and supplementing a number of articles of *Securities Law No. 62/2010/QH12* dated 24 November 2010.
- d. *Circular No. 17/2007/TT-BTC* dated 13 March 2007 detailing Investor Profile Questionnaire (corporate bond included).
- e. *Decision 07/2008/QD-NHNN* by the SBV governs particular credit institutions operating in Viet Nam, including state-run and joint-stock commercial banks, foreign bank branches, and 100% foreign-owned and joint-venture banks.⁹
- f. *Decree 90/2011/ND-CP* dated 14 October 2011 and issued by the government to regulate the issuance of corporate bonds; Decree 90 replaced Decree 52/2006/ND-CP dated 19 May 2006 regulating the issuance of corporate bonds, and replaced the concept of the issuance of corporate bond to the international market which was stipulated in Decree 53/2009/ND-CP regulating the issuance of international bonds.

These laws and regulations constitute the regulatory framework for issuing corporate bonds.

G. Transfer of Interests in Bonds

Listed bonds are entered in the VSD. Unlisted bonds, on the other hand, depend upon the charter and terms and conditions of the bonds. Normally, the issuer issues the new bond certificates and enters the bonds into the bond register.

The transfer of securities ownership is provided in Article 54 of *Securities Law No. 70/2006/QH11*, which states that:

1. The transfer of securities ownership with respect to categories of securities registered at the securities depository center shall be undertaken via VSD.
2. The validity of the transfer of securities ownership at VSD shall be as follows:
 - (a) Where securities have been centrally deposited at VSD, the transfer of securities ownership shall take effect on the date of book entry in the securities depository account at VSD.
 - (b) Where the securities have not been centrally deposited at VSD, the transfer of securities ownership shall take effect on the date of recording on the securities registration book managed by VSD.

According to Article 4 of *Circular 43 /2010/TT-BTC* dated 25 March 2010 amending *Decision 87/2007/QD-BTC*, the transfer of ownership of listed or registered securities for trading shall be subject to the principle that any securities holders who intend to transfer their ownership of securities shall deposit such securities at VSD via depository members to buy or sell such securities via the stock exchanges, or transfer their ownership as prescribed in Clause (b) of Article 4, except for any transfer of ownership due to inheritance factors or the fact that the issuer redeems its shares from employees upon employment termination. The VSD shall only execute transfers of ownership of securities outside its securities trading system if such transfers are

⁹ State Bank of Vietnam. http://sbv.gov.vn/wps/SBVDataStore/upload/EN_VBQPPL/VANBANSAN/VB706.HTM

non-commercial or fail to be executed via trading systems at stock exchanges. Such transfers shall include the following cases:

- (a) Securities made as a present or via inheritance according to the *Civil Law*.
- (b) Odd-lot transactions according to the law of securities and securities market.
- (c) Issuers, or labor unions of issuer, buyback preferred shares of their employees, which terminate their labor contracts, to become treasury shares and bonus shares for their current employees.
- (d) Issuers use Treasury shares as bonus, or the labor union of the issuer distributes bonus shares to their employees.
- (e) Foundation shareholder transactions in restricted time.
- (f) Issuers change their strategic shareholders in restricted time.
- (g) In case securities have registered in VSD and have been accepted in principle by the exchanges but have not listed on the exchanges yet.
- (h) Investors leave the securities in trust to a fund manager in case the fund manager accepts to manage the trusted investment portfolio by assets.

Differing from equity, there is no general meeting for bondholders. Bond is a debt instrument, thus the rights of bondholders are stipulated in *Decree 01/2011/ND-CP* as follows:

- (i) Bondholders are guaranteed for on-time and sufficient settlement of interest and principal.
- (ii) Bondholders have entitlements to transfer, give, make as a present, inherit, discount, and pledge in credit relationship and civil relationship according to current law.

As for guarantees for bond settlement,

- (a) The government commits to protect bondholders' interests for corporate bonds guaranteed by the government, according to *Decree 01/2011/ND-CP*.
- (b) For guaranteed corporate bonds, according to Clause 44 of *Decree 52/2006/ND-CP*, if the issuer fails to pay the interest and principal settlement, the guaranteed asset will be liquidated to refund the due debt. In case other credit organizations act as settlement guarantor, they have the responsibility to refund the debt to the bondholder.

There is no specified company system to guarantee for corporate bond settlement in Viet Nam.

H. Definition of Securities

Pursuant to Article 3 of the amended and supplemented *Securities Law No. 62/2010/QH12* and Article 6 of *Securities Law No. 70/2006/QH11*, securities are defined as evidence from an issuing organization certifying the lawful rights and interest of an owner with respect to an asset or capital portion. Securities may take the form of certificates, book entries or electronic data, and shall comprise the following types:

- (1) Shares, bonds, and investment fund certificates;
- (2) Share purchase rights (rights issue), warrants, call options, put options, future contracts, groups of securities and securities indices;
- (3) Investment capital contribution contracts; and
- (4) Other types of securities stipulated by the MOF.

I. Self-Governing Rules behind the Market

The Vietnam Bond Market Association (VBMA) is regarded as the Viet Nam bond market's self-governing organization. It is a non-profit organization aimed to promote the professional and effective development of the Viet Nam bond market, guarantee the legitimate rights and interests of members, and, at the same time, ensure national interest.¹⁰

1. The VBMA's roles and functions are

- (a) Standardize trading practices and market conventions for bonds and other debt instruments of similar nature in the Vietnamese bond market;
- (b) Enhance the regional and international integration of the bond market in general and of the members in particular through encouraging the adoption of global best practices by market participants under the conditions of the Vietnamese bond market;
- (c) Establish the code of conduct and ethics to govern the relationship of market participants to ensure equality among them;
- (d) Improve market expertise and skills by conducting activities to aggregate and analyze bond information, consulting, training and provision of facilitating services to members and other related participants in trading bonds and other debt instruments of similar nature in the Vietnamese bond market;
- (e) To be a forum and bridge for exchanging and updating bond information, strengthen collaboration, and promote mutual understanding among its members, and between its members and Vietnamese regulatory authorities, as well as related international organizations; to make comments on related policies; to support state-competent bodies in improving policies and the legal framework of the bond market in Viet Nam; and
- (f) Update, aggregate, store, and build a database of bond market information, thus help increase transparency in the Vietnamese bond market.

2. History of the Vietnam Bond Market Association

In recent years, the government has been conducting a reform of Viet Nam's financial market. Besides the state's initiatives, many organizations, businesses, as well as bond market participants, have made great efforts to contribute to develop the bond market. In November 2006, a group of local and international commercial banks, securities companies, fund management companies, and insurance companies formed the Vietnam Bond Market Forum (VNBF) to promote bond trading through disseminating and sharing market information, and standardizing commercial activities in the bond market in Viet Nam. VNBF was directed by an executive board voted from representatives of members who were active in the Vietnamese bond market. Its executive board worked on a part-time basis, and met monthly to

¹⁰ Vietnam Bond Market Association. <http://www.vbma.org.vn/vbma/home.do>

discuss and consent to the Forum's plan of activities and allocation of work. Over a period of 3 years, the VNBF's activities brought about initial results for market development. However, operating as a forum, VNBF faced its own limitations such as matters concerning legal status, fundraising, and public recognition. In March 2007, VNBF members collaborated and decided to begin procedures to apply for an official permit to establish a professional association in compliance with the laws of Viet Nam. This helped raise its legal status and financial capacity aimed to strengthen activities to effectively and practically contribute to the development of the bond market in general and bring about benefits to the members in particular. The association was named the Vietnam Bond Market Association (VBMA). At that time, VNBF had more than 50 members, and planned to increase the number to 100 or more when it becomes an association. Viet Nam's authorities such as the SSC, the MOF, and the SBV were all in favor of the transformation from a forum to an association. VNBF officially established its office in May 2007, with an executive board secretary working full-time and responsible for the operations of the office. The draft charter was first completed in June 2008. In August 2008, the MOF approved the list of the Preparation Committee for establishing the VBMA. On 22 May 2009, the Minister of Interior issued an official decision allowing the establishment of the VBMA. On 31 December 2009, based on the submission letter of the association's chairman, the Minister of Interior decided to approve VBMA's Charter, thus legally enabling the VBMA to set up its management and execution bodies to execute and coordinate its activities. The Executive Committee, Standing Committee, and VBMA Office commenced operating in early 2010 and have stabilized their operations step by step. At the end of November 2010, VBMA had 59 members. Of these, 54 were institutional members comprised of local and foreign commercial banks, companies in finance, leasing, securities, fund management, insurance and law consultancy, and five individual members. Figure 1.1 shows the plan to develop the Viet Nam bond market.

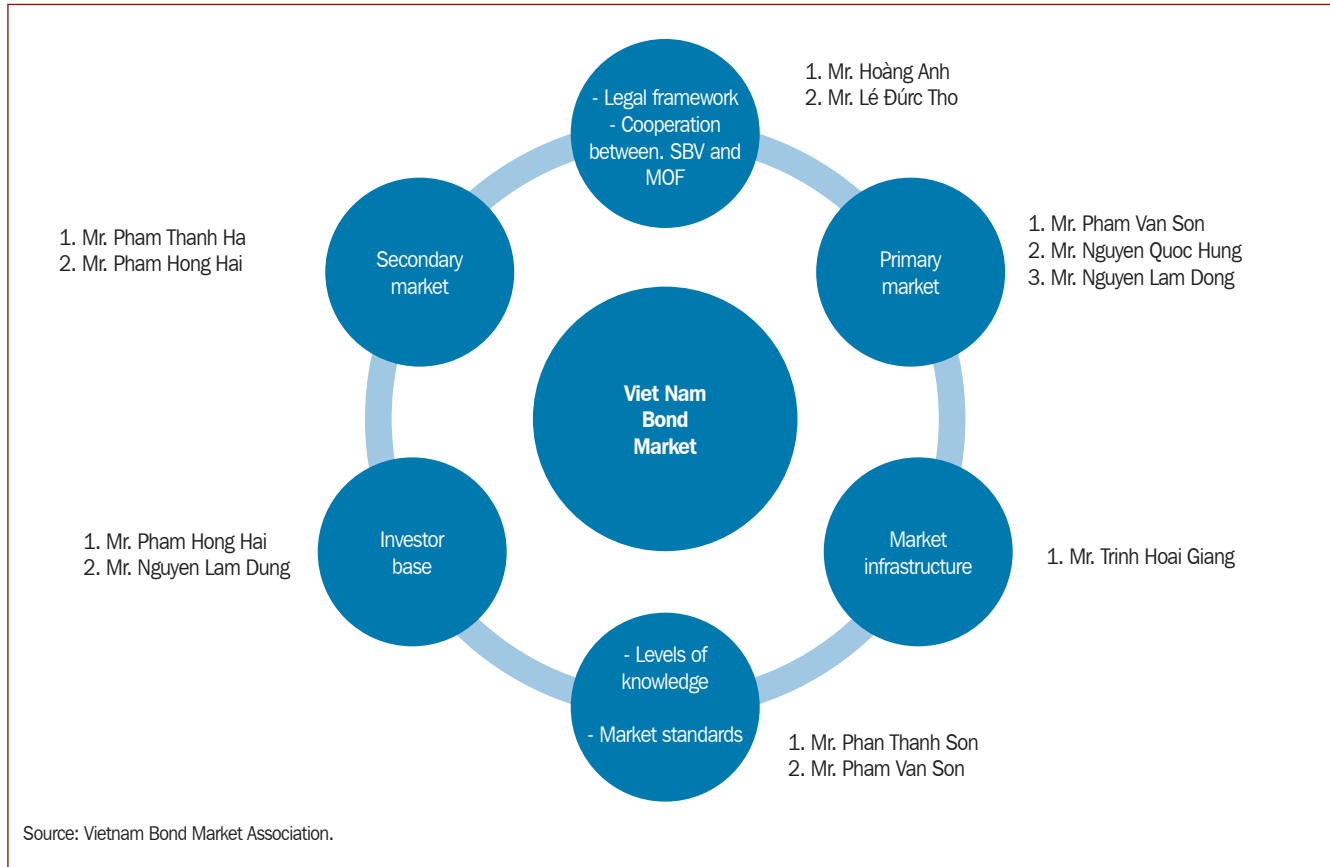
Figure 1.1 Plan to Develop the Viet Nam Bond Market

3. The Vietnam Bond Market Association Code of Conduct

On 01 September 2009, VBMA released its Code of Conduct (COC). It is intended to be observed by VBMA member organizations engaging in bond trading activities, whether as part of the market-making or proprietary trading, and/or brokerage services for bond transactions. Its main aim is to set out the principles and standards which VBMA members should follow when conducting their bond trading business in a manner that exhibits a high degree of professionalism, integrity, and fairness. Based on the proposal made by VBMA, the MOF officially authorizes the association to release the COC.

To confirm their commitment, 21 full and associate members affixed their signatures to the Memorandum of Understanding (MOU) for Adherence to the COC and to the agreement to supply information to VBMA's website. This was witnessed by representatives from the MOF, SSC, HNX, VSD, international agencies, and local television. Other members were to sign the MOU in due course as they were not able to attend the MOU signing, or they still needed the opinion of their respective legal departments as a procedure before signing.¹¹

¹¹ Footnote 9. <http://www.vbma.org.vn/vbma/downloadFile?fileid=59>

J. Bankruptcy Procedures

In Viet Nam, bankruptcy of a corporate bond issuer has not occurred yet. If it happens, the *Bankruptcy Law 2004* will be applied.

There are several measures to protect investors in accordance with *Securities Law No. 70/2006/QH11*, which took effect on 1 January 2007. Various regulations applicable to trading activities and related issues also exist.¹² Based on the amended *Constitution of the Socialist Republic of Vietnam*, *Bankruptcy Law No. 21/2004/QH-11* was issued on 15 June 2004 to regulate bankruptcy-related issues applicable to enterprises and co-operatives in Viet Nam.¹³ *Decision No. 114/2008/ND-CP* was published on 3 November 2008, which gives further guidance on several articles in the *Bankruptcy Law* and their application to companies operating in the insurance industry, securities services, and financial services.¹⁴ The guidance mainly covers the bankruptcy procedure required for bankrupt companies, including procedure for bankruptcy document submission, payment recovery plan, asset dissolution, and bankruptcy announcement. The decision mentions the regulatory authorities, the MOF and the SSC, apart from the judge, being the two main bodies involved in the review of the bankruptcy process of the companies. These regulatory bodies have the authority to require the enterprises to conduct necessary steps to recover their payment capacity and financial conditions, or to further process bankruptcy procedures as needed.

“The Asia-Pacific Restructuring and Insolvency Guide 2006” explains the restructuring and insolvency frameworks of Asia-Pacific countries.¹⁵ According to the report on Viet Nam, prior to October 2004, the legal framework for bankruptcy in Viet Nam consisted of the *Law on Business Bankruptcy* dated 30 December 1993, the *Decree on Business Bankruptcy* dated 23 December 1994, and various subordinate legal instruments (collectively referred to as the ‘old Bankruptcy Law’). The old Bankruptcy Law was generally considered to be deficient and, by the end of the East Asian economic crisis in 2002, the courts had received only 151 petitions, with a mere 46 of these resulting in a declaration of bankruptcy. The old Bankruptcy Law was replaced by the *Bankruptcy Law* dated 15 June 2004, which came into effect on 15 October 2004, and the *Resolution of the Judges’ Council* of the Supreme People’s Court guiding the implementation of the *Bankruptcy Law* dated 28 April 2005 (collectively referred to as the ‘Bankruptcy Law’).

The Bankruptcy Law applies to enterprises and cooperatives established in accordance with Vietnamese law. The list of enterprises covered is extensive and includes SOEs, enterprises belonging to social and political organizations, limited liability companies, joint stock companies, partnerships, private enterprises, and foreign-invested enterprises. The Bankruptcy Law does not apply to individuals or certain small business entities such as registered family and household businesses.

¹² Footnote 5. Accessed from the Vietnam Business Forum website. http://www.vbf.org.vn/downloads/Securities%20Law_no_70-2006-OG_ENG.pdf

¹³ Government of the Socialist Republic of Viet Nam. 2004. *Bankruptcy Law* (No. 21/2004/QH11 of June 15, 2004). http://www.dncustoms.gov.vn/web_english/english/luat_pl/BANKRUPTCY%20LAW%202004.htm

¹⁴ Hanoi Stock Exchange. [http://www.hsx.vn/hsx_en/Modules/Phapquy/VAN_BAN_PHAP_QUY_FILE_download.aspx?ID_FILE=1603&TEN_FILE=D114gv3Nov08BankruptcyInsuranceSecuritiesSectors\[2\].pdf](http://www.hsx.vn/hsx_en/Modules/Phapquy/VAN_BAN_PHAP_QUY_FILE_download.aspx?ID_FILE=1603&TEN_FILE=D114gv3Nov08BankruptcyInsuranceSecuritiesSectors[2].pdf)

¹⁵ Asian Development Bank. 2006. *The Asia-Pacific Restructuring and Insolvency Guide 2006*. <http://www.adb.org/Documents/Guidelines/restructuring-insolvency/restructuring-insolvency.pdf>

It stipulates that additional regulations will be issued to address the insolvency of enterprises in certain specific sectors.

Voluntary liquidation and restructuring are addressed by separate legal frameworks depending on the type of enterprise. An enterprise experiencing financial difficulty may consider restructuring or terminating its operations in accordance with the relevant legislation. Chapter VII of the *Law on Enterprises*, which governs limited liability companies, joint stock companies, partnerships and private enterprises, deals with the dissolution and reorganization of enterprises, and allows for the division, separation, consolidation, merger, and conversion of enterprises. The *Law on Foreign Investment* governs the dissolution, division, demerger, consolidation and conversion of FIEs. Both laws were replaced by a unified *Law on Enterprises*, which was passed on 29 November 2005 and came into effect on 1 July 2006, and contains similar provisions.

Chapter VII of the *Law on State-Owned Enterprises* deals with the reorganization and dissolution of SOEs. Chapter VIII of the law addresses the conversion of SOEs, including equitization (i.e., the process of conversion into a joint stock company).

K. Meetings of Bondholders

In Viet Nam, there is no official concept of meetings of bondholders yet.

L. Event of Default

At present, the settlement of default in bond transactions which trade on exchanges have not occurred yet. If default occurs in securities or cash settlement, the principal and resolution sequence will be according to settlement regulations of the VSD. In Viet Nam, there is no precedent of a default of a corporate issuer in interest and principal settlement yet. However, a bondholder is a creditor of the issuer and, if default happens, *Bankruptcy Law No. 2112004/QH11* will be applied and the issuer will announce the bankruptcy status.

M. Parties Involved in Bond Issuance and Their Respective Roles

Viet Nam's bond market participants include issuers from the government and corporate sectors. Major bond investors include commercial banks and domestic life insurance companies. A number of authorized securities companies and a few market associations also participate in the market. However, a domestic rating agency currently does not exist.

1. Government

The government forms a large share of bond issuers in Viet Nam, particularly the central government and SOEs. Corporate issuers represent a small share of the bond market. The national government is the largest issuer of debt securities and the VDB, which issues government-guaranteed bonds, is the second largest issuer followed by

the Vietnam Bank for Social Policies (VBSP) and the Vietnam Expressway Corporation (VEC). Municipal bonds are issued by city municipalities and provincial governments. Corporate bonds are issued by SOEs and private enterprises.

SOEs also form a large number of bond issuers in Viet Nam. For example, PetroVietnam is the first SOE to issue bonds and others are expected to follow suit as the equitization of SOEs progresses. The Bank for Investment and Development of Viet Nam (BIDV) signed an agreement with the Debt Asset Trading Corporation to assist in the financial restructuring of SOEs, including the issuance of bonds for its own financing needs.

2. Investors

The domestic investor base is still small. The ability to absorb supply-and-demand shocks is limited. Commercial banks and domestic life insurance companies are the major bond investors in Viet Nam. Commercial banks are also major bond investors. Major state-owned banks include the Vietcombank, Vietnam Bank for Rural and Agriculture Development, Industrial and Commercial Bank of Vietnam, and BIDV.

Domestic life insurance companies have placed 49% of their total investments in government bonds. Manulife Viet Nam Insurance Company and Prudential Viet Nam are the first two wholly foreign-owned life insurance companies in Viet Nam. Other insurance companies include Bao Viet Insurance, Bao Minh Insurance, and Vien Dong Insurance. The government is considering streamlining the insurance industry to mobilize additional capital.

Other institutional investors include Viet Nam's Social Security Fund, finance companies, securities firms, and, more recently, investment funds. In March 2004, the Vietnam Fund Management Company (VFM) introduced the Vietnam Securities Investment Fund (VF1), which is the country's first securities investment fund. VFM is a joint venture between Sacombank and Dragon Capital. About one third of VF1's capital is invested in long-term government bonds. Other investment funds include Vinacapital and Dragon Capital.

Off-shore investors are still limited while there are no limitations on foreign holdings of bonds.

3. Intermediaries

A number of licensed securities companies are authorized to offer a full range of securities services including underwriting, brokerage, advisory, portfolio management, and trading. A list of securities companies can be found in the MOF website.

Foreign banks are also licensed as custodian banks for foreign individual and institutional investors on the exchanges.

4. Other Market Associations

a. Vietnam Association of Securities Business

Established in May 2004, the Vietnam Association of Securities Business comprises 13 licensed securities companies and an investment fund management company.¹⁶ The association facilitates relations among its members and acts as a link among market participants, securities trading agencies, state entities, financial organizations, and investors.

b. Vietnam Association of Financial Investors

The Vietnam Association of Financial Investors (VAFI) brings together investors, policymakers, and financial advisers to strengthen and enhance Viet Nam's capital markets.¹⁷

¹⁶ Asian Development Bank. 2006. *The Asia-Pacific Restructuring and Insolvency Guide 2006*. <http://www.adb.org/Documents/Guidelines/restructuring-insolvency/restructuring-insolvency.pdf>

¹⁷ Vietnam Association of Financial Investors. <http://www.vafi.org.vn/2006/index.php>

II. Primary and Secondary Markets Regulatory Framework

A. Viet Nam Market Regulatory Structure

Figure 2.1 Viet Nam Market Regulatory Structure

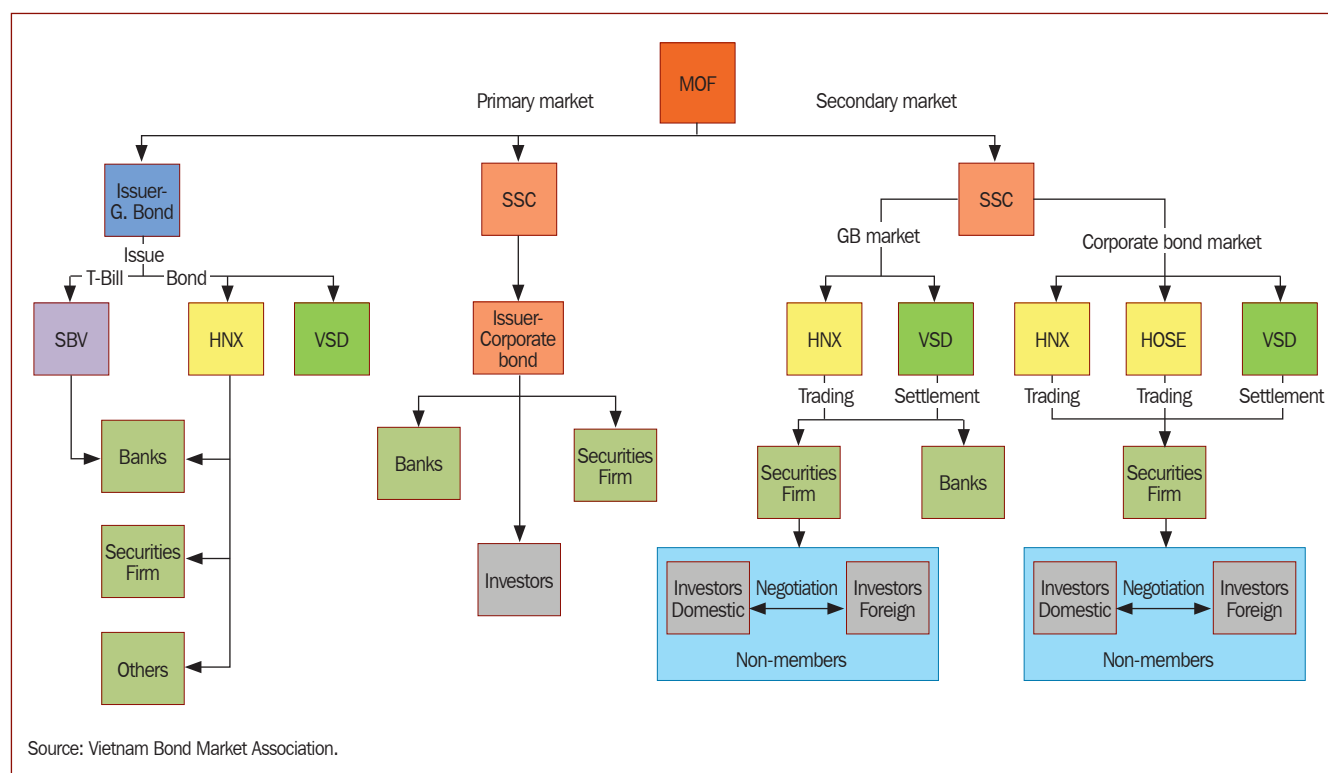

1. Regulatory Environment

The Ministry of Finance (MOF) and the State Bank of Vietnam (SBV) jointly regulate the capital markets. SBV is the central bank and chief regulatory body for all issues affecting the banking industry. It administers monetary, credit and banking regulations, and issues regulations on matters such as exchange controls, interest rates and banking license application procedures.

The State Securities Commission (SSC), which reports to the Minister of Finance, regulates the securities market. The Ho Chi Minh Stock Exchange (HOSE), Hanoi Stock Exchange (HNX), and the Vietnam Securities Depository (VSD) are under SSC jurisdiction, and are required to adhere to regulations relating to accounting, auditing, and statistical reporting. Please refer to Figure 2.1.

2. The State Securities Commission

The SSC regulates and acts as the supervisory agency for the securities market, and HOSE and HNX. All exchange regulations are issued by the SSC, which has the power to suspend trading in securities, delete listings of companies to protect investors' interests, and grant or revoke licenses relating to securities issuance, brokerage and custody services. Effective March 2004, the SSC came under the jurisdiction of the MOF. The following are some important functions of the SSC:

- (i) Report to the MOF legal documentation relating to securities and securities markets, its strategies, matrixes, long-term and annual plans.
- (ii) Advise the MOF to set up, suspend, or disperse the operations of the stock exchanges, the VSD, and other institutions related to the securities market.
- (iii) Ensure that proper reporting by participants is done.
- (iv) Set standard procedures and processes to be applied in organizations under applicable laws in the securities and securities market.
- (v) Issue, suspend, or revoke certificates of registration of securities.
- (vi) Supervise the compliance of rules and regulations.
- (vii) Implement regular inspections and provide guidelines on securities and securities markets.
- (viii) Organize scientific research on and analyses of the securities and securities market.
- (ix) Manage the modernization of the securities market as stipulated by law.
- (x) Provide training programs to market participants.

In addition to the above, the SSC also performs other duties and functions assigned by the MOF.¹⁸

3. Ministry of Finance

The functions of the MOF as a government agency include:

- (i) Managing the State budget;
- (ii) Managing the collection of tax, fees, and other revenues under the State budget;
- (iii) Managing the budget fund, the State reserve fund, and other State financial funds;
- (iv) Managing the national reserves and State assets;
- (v) Managing domestic and foreign government borrowing and debt servicing, as well as international grants; and
- (vi) Issuing government bonds.

In addition, the MOF is also responsible for:¹⁹

¹⁸ State Securities Commission. http://www.ssc.gov.vn/portal/page/portal/ssc_en

¹⁹ Ministry of Finance. http://www.mof.gov.vn/portal/page/portal/mof_en

- (i) Regulation of banks and non-bank institutions and
- (ii) Participating in the management of the stock market.

4. State Bank of Vietnam

The SBV is the central bank of Viet Nam. Its main functions are to formulate and implement the national monetary policy, stabilize the currency, control inflation, and improve socioeconomic development, as well as manage currency and banking activities and contribute to the development of the market structure. It regulates foreign exchange controls for stock market activities.²⁰ The operational functions of the SBV are as follows:

- a. Implementation of the National Monetary Policy.
 - (i) Outlining and implementing the annual plan of the monetary policy.
 - (ii) Apply instruments to manage the flow of money in and out of the economy by providing refinancing, monitoring exchange rates, ensuring reserves, and jointly manage open-market professional operations.
- b. Issuance of notes and coins by introduction, control and supervision of the implementation of monetary issuance regulation.
- c. Credit operations by lending short-term loans to approved credit organizations under crisis.
- d. Account opening, payment and cash operations.
 - (i) Open accounts with international banks and monetary institutions.
 - (ii) Provide inter-bank payment system and services.
 - (iii) Conduct transactions for the State Treasury.
- e. Foreign exchange management.
 - (i) Outline and introduce legal documents with respect to foreign exchange policy.
 - (ii) Issuance and suspension of foreign exchange operation licenses.
 - (iii) Management of foreign exchange reserves.
 - (iv) Buy and sell foreign exchange in the international market as per regulations.
- f. Market information
 - (i) Information service on currency and banking operations provided to organizations.
 - (ii) Publish periodic information on financial operations.

5. Stock Exchanges and Securities Depository

The Hanoi Stock Exchange (HNX) and The Hochiminh City Exchange (HOSE) are government-owned and operate under the oversight of the State Securities Commission. Each exchange offers trading memberships to local market participants qualified under prevailing regulations.

HNX and HOSE fulfill similar and also distinct functions in the Viet Nam bond market, as described in context of the respective market segments:

²⁰ The most recent guideline related to foreign exchange control *Circular 19/2011/TT-NHNN*. State Bank of Vietnam. 2011. *Circular 19/2011/TT-NHNN* (Guiding the foreign exchange control with regard to the issuance of international bonds by enterprises that are not guaranteed by the Government). http://www.sbv.gov.vn/wps/SBVDDataStore/upload/EN_VBQPPL/

For the Government Bond Market

HNX is authorized by MOF to facilitate the secondary market in government bonds and acts as the only issuing agency for government bonds which are issued to the market via auction.

HNX's roles and functions in the Viet Nam government bond market are as follows:

In General

- Ensure open, fair and successful bond trading in the market.
- Disseminate information in accordance with the Securities Law and other relevant documents.
- Provide trading information and training to the market participants.
- Consult regulators and authorities in setting up and revising legal documents relating to bond issuance and trading in the market.

For the Primary Market

- Build and maintain the bond auction system to meet the diversified issuing needs.
- Set up and develop a large auction member base comprising many organizations, from financial institutions, investment funds to normal bond trading entities, to create key players in promoting the auction activities.
- Cooperate with issuing entities to develop new fixed income products.
- Run the sole and comprehensive bond auction database for all market participants.

For the Secondary Market

- List all kinds of government bonds, government-guaranteed bonds and municipal bonds. Government-related issuing agencies list qualified corporate bonds upon requests from corporate issuers.
- Exclusive operate the government bond trading system as designated and authorized by laws and regulators.
- Set up, develop, increase the market member base, from securities companies to other financial institutions. Through this, enhance the approach to the market for the investors, and increase the linkage between the HNX and members in order to diversify the trading products in the government bond market.
- Own and operate a database on government bond trading data and information, and enhance the clearance and result of trading activities in the market.
- Specifically set up and operate the comprehensive Infobond system, and enhance its volume and quality.
- Provide real-time data, historical data and other information to market members, regulators and information providers according to purposes and stated laws.
- Develop new trading derivatives products, such as futures and options, to meet the market's needs.

For the Corporate Bond Market

HNX and HOSE are responsible for running their own trading platforms for corporate

bond trading. Only listed corporate bonds are eligible to be traded on the exchanges.

The roles and functions of HNX and HOSE with regards to the corporate bond market include:

- Approve the listing requirements by the issuing companies according to the stipulated criteria governing the corporate bond market by each exchange.
- Concentration of the listing of corporate bonds in their own market according to the listing selection by the issuing companies.
- Operate the trading activities of corporate bonds on the stock trading platform.

HNX built its trading system for both corporate and government bonds in-house while HOSE uses a corporate bond trading system developed in Thailand.

For the Treasury Bills Market

To improve the liquidity and attractiveness of T-bills, the Ministry of Finance and the State Bank of Vietnam mutually agreed to have T-bills listed and traded on HNX's bond trading system. The T-bills trading platform will be launched by early May 2012, with the participation of Open Market Operation (OMO) members and government bond market participants.

Vietnam Securities Depository (VSD)

The Vietnam Securities Depository (VSD) provides depository services to local market participants. Settlement for transactions in both government and corporate bonds listed on the exchanges are conducted via VSD. VSD commenced operations in May 2006.

VSD's roles and functions in the Viet Nam bond market include:

- Provide services of registration, depository, clearing and settlement for listed bonds on the exchanges.
- Issue the local code for bonds and their ISIN.
- Organize the rights implementation for bondholders on behalf of bond issuers.
- Serve as the paying agent for bond interest and dividends.
- Serve as the agency for the transferring and carry out the ownership transfer for bonds traded on the exchanges.

Transfer of ownership is effected by VSD not only for transactions done on the exchange platforms but also for special cases such as a merger between enterprises and off-exchange transactions. Some specific exceptions exist, such as for ownership transfers as a result of inheritance or court orders."

B. Important Legislations and Regulations in the Viet Nam Bond Market

In September 2005, limits on aggregate foreign investment were increased from 30% to 49% of listed equities. There are no separate individual investment limits in

equities for foreign investors. There are also no foreign investor limits for the fixed-income market.

For listed companies in the banking industry, a different limit is applied. For Sacombank, which started listing on HOSE on 12 July 2006, a foreign investor limit of 30% is being promulgated by the SBV.

1. Key Legislation in Regulating Securities and the Securities Market

A key legislation in regulating securities and the securities market is the Securities Law 2006 (Law No. 70/2006/QH11), which took effect on 1 January 2007. The law was amended and became effective on 01 July 2011 (Law No. 62/2010/QH12). The scope of the law covers public offers and non-public offer (private placement) of securities, listing and trading securities, and conducting business and investing in securities, securities services and the securities market. It is applicable to all Vietnamese and foreign institutional and retail investors, and all other organizations and individuals involved in securities activities and the stock market. Some extracts related to these offers of securities from the Securities Law and Amended Law are shown in Box 2.1 with emphasis added and with the amended and supplemented provisions.

Box 2.1 Extracts from the Securities Law 2006 on Public Offers

Article 6. Definition of terms

10. Investors mean domestic or foreign institutions and individuals participating in investment in the securities market.
11. Professional securities investors mean commercial banks, financial companies, financial leasing companies, insurance organizations and securities trading organizations.
12. Public offering means an offering of securities according to one of the following methods:
 - (a) Via mass media, including Internet;
 - (b) Offering of securities to 100 or more investors, excluding professional investors;
 - (c) Offering to an unspecified number of investors.
17. Listing is to make securities eligible to be transacted at the Stock Exchanges or Securities Trading Centers.

CHAPTER II OFFERING OF SECURITIES TO THE PUBLIC

Article 10. Face value of securities

2. The par value of bonds to be offered to the public shall be VND100,000 and multiples of VND 100,000.

Article 12. Conditions for offering securities to the public

2. Conditions for offering bonds to the public:
 - (a) The enterprise must have its paid-up charter capital at the time of registering for public offering of at least VND10 billion in book value;
 - (b) Being profit making in the year preceding the year of such registration for offering; having no accumulated losses up to the year of registration for offering or overdue debts of over 1 year.
 - (c) Having a plan for offering and use and refund of capital received from the offering approved by the Board of Management, the Board of Members, or the enterprise's owner.
 - (d) Having commitment to fulfill obligations of the issuer towards investors, regarding conditions for issuance and payment, ensuring the investors' legitimate rights and interests, and other conditions.
4. The Government shall stipulate the conditions for offering securities to the public applicable to State-owned enterprises, foreign-invested enterprises which are transformed into joint stock companies, and newly established enterprises in the fields of infrastructure or high technology, and offering of securities overseas and other specific cases.

Article 13. Registration of offering securities to the public

1. The issuer carrying out the offering of securities to the public shall register with the State Securities Commission.
2. The following cases shall not be subject to registration for offering securities to the public:
 - (a) Offering of bonds of the Vietnamese government;
 - (b) Offering of international financial institutions' bonds accepted by the Vietnamese Government;
 - (c) Offering of shares to the public by State-owned enterprises which are transformed into joint stock companies;
 - (d) The sale of securities upon a court judgment or decision, or the sale of securities by the managers or persons entitled to assets in case of bankruptcy or insolvency.

Box 2.1 continuation

Article 14. Dossier of public securities offering registration

2. The dossier for registration of offering of bonds to the public shall include:
 - (a) The registration of offering of bonds to the public;
 - (b) The prospectus;
 - (c) The Charter of the issuer;
 - (d) Decisions of the Board of Management, Board of Members, or the enterprise's owner approving of the plan for offering and use and repayment of capital received from the public bond offering;
 - (dd) The commitment to fulfill the issuer's obligations to investors, regarding the conditions for issuance, payment and ensuring the investors' legitimate rights and interests, and other conditions.
 - (e) Underwriting commitment (if any).

Article 15. The prospectus

1. Regarding the offering of shares or bonds to the public, the prospectus shall include the following information:
 - (a) Brief information on the issuer, including its model of organizational apparatus, business activities, property, financial situation, the Board of Management or the Board of Members, or the company's owner, the (General) Director, the Deputy (General) Director, and shareholder structure (if any);
 - (b) Information on the offering and securities to be offered, including conditions for offering, risk factors, the proposed plan of profits and dividends of the most recent year following the issuance of securities, the plan of issue and use of capital received from the offering;
 - (c) The financial statements of the issuer for the last 2 years as stipulated in Article 16 of this Law;
 - (d) Other information as stipulated in the Prospectus Form.
4. The Ministry of Finance shall provide the form of the Prospectus.

Article 16. Financial statements

1. A financial statement includes the balance sheet, the report on production and business results, cash flow report, and presentation of the financial statement;
2. In case where the issuer is a holding company, it shall have to submit a consolidated financial statement in accordance with the law on accounting.
3. Annual financial statements must be audited by the approved auditing company.
4. In case where the dossier is submitted before the 1st of March annually, the financial statements of the preceding years in the initial dossier may be unaudited, but the audited financial statements of the last 2 consecutive years must be presented.
5. Where the period from the end of the most recent financial statement to the time of submission of the valid dossier of registration for public offering of securities to the State Securities Commission is more than 90 days, the issuer must make additional financial statements up to the most recent month or quarter.

Article 17. Responsibilities of organizations or individuals in relation to the dossier of registration for offering of securities to the public

1. The issuer shall be responsible for the accuracy, honesty and adequacy of dossier of public securities offering.
2. The issuing consultancy companies, underwriters, approved auditing companies and the signatories of the auditor's report, and any organizations or individuals certifying the dossier must be responsible within their scope relating to the dossier of public securities offering.

Article 18. Amendments, supplements of the dossier of registration for public securities offering

1. During the time of examination of the public securities offering registration dossier, the issuer shall be obliged to amend or supplement the registration dossier if it discovers that the registration dossier contains inaccurate information on an important issue, or omits any important content that must be included in the dossier as stipulated, or where it is deemed necessary to provide explanation for any matter that may cause any misleading [information].

Article 19. Information prior to the public securities offering

During the time the State Securities Commission reviews the public securities offering registration dossier, the issuer, the underwriter(s), and other relevant organizations and individuals may only use, in an honest and accurate manner, the information described in the Prospectus submitted to the State Securities Commission to explore the market, provided that they shall clearly specify that the information on the date of issue and the securities selling price is the proposed information. The exploration of markets must not be conducted through the mass media.

Article 20. Effectiveness of the public securities offering registration

1. Within 30 days as from the date of receiving the valid dossier, the State Securities Commission shall examine and grant the Certificate for Public Securities Offering. In case of refusal, the State Securities Commission must respond in writing and clarify the reasons thereof.
2. The Certificate for Public Securities Offering granted by the State Securities Commission shall be a document certifying that the public securities offering registration dossier fully satisfies the conditions and procedures provided by the law.
3. Within 7 days from the date the Certificate for Public Securities Offering comes into effect, the issuer shall have to publish the Announcement of Offering in three consecutive issues of one electronic newspaper or written newspaper.

continued on next page

Box 2.1 continuation

4. Securities shall only be offered to the public after the announcement has been made as stipulated in clause 3 of this Article.

Article 21. **Distribution of securities**

1. The distribution of securities shall only be conducted after the issuer ensures that securities buyers can access the prospectus in the public securities offering registration dossier announced at places mentioned in the Announcement of Offering.
2. The issuer, underwriter, or issuing agency must distribute securities in a fair and public manner and ensure that the time limit for registration of buying securities applicable to investors is at least 20 days; such time limit shall be stipulated in the Announcement of Offering.
In case the amount of securities registered to buy exceeds the amount of securities permitted to be issued, the issuer or the underwriter shall have to distribute the securities permitted to be issued to the investors in proportion with their purchase registration rate.
3. The money paid for securities shall be transferred into a blocked bank account until the issue is completed and reported to the State Securities Commission.
4. The issuer shall complete the distribution of securities within 90 days from the effective date of the Certificate for Public Securities Offering. In case where the issuer cannot complete the distribution of securities to the public within such time limit, the State Securities Commission shall consider its extension which must not exceed 30 days.
In case of registration of securities offering in a number of tranches, the period between one tranche and the next tranche must not exceed 12 months.
5. The issuer or the underwriter shall report the offering result to the State Securities Commission within 10 days from the date of completing the offering, together with the certification of the bank where the blocked account is opened for the money received in the tranche.
6. The issuer, underwriter, or issuing agency shall transfer the securities or the certificate of securities ownership to the buyers within 30 days from the date of completing the offering.

Note: Emphases added by ADB Consultants.

Source: Government of the Socialist Republic of Viet Nam, 2006, Securities Law. <http://www.telchar.com/capmks/VietnamSecuritiesLaw2006English.pdf> or <http://lawfirm.vn/?a=doc&id=2012>

2. Special Regulation for Investment Activities of Foreign Investors

Decision No.121/2008/QD-BTC, passed on 24 December 2008, is a special regulation for investment activities of foreign investors, which took effect on 17 February 2009. This Decision provides detailed guidelines for foreign investors investing in the Viet Nam stock exchanges, the general principles of which have been provided for ease of reference.

3. Restrictions for Foreign Investors

The Vietnamese market is open to local and foreign investors. However, foreign investors need to obtain a securities trading code prior to being allowed to invest in the securities market. There is no limit imposed on investments in government bond instruments for foreign and domestic investors, both institutional and individual. Certain limits apply to investment in corporate bonds, in particular for commercial banks.

4. Securities Trading Code

Foreign investors who wish to invest in Viet Nam must first apply with the VSD to obtain a securities trading code. The application is comprised of the following documents:

- (i) The Application for Registration of Securities Trading Code Form, which is a standard form. An authorized signatory of the foreign investor must sign this form.

- (ii) The Information Slip of Foreign Institutional Investor Form, which is also a standard form. An authorized signatory of the foreign investor must sign this form. A notary public or equivalent authority from the foreign investor's country of registration must also certify this form.
- (iii) The Information Slip of Appointed Representative of Foreign Institutional Investor, which is another standard form. The same individual who signed the Information Slip of Foreign Institutional Investor must sign this form. A notary public or equivalent authority from the foreign investor's country of residency must also certify this form.
- (iv) The Letter of Appointment of Foreign Institutional Investor's Representative, which is a set form. The form must be certified by the foreign investment organization and a competent agency.
- (v) Copies of the license of establishment of the investor organization, notarized or verified by a notary public or equivalent entity of the investor's country, and the license of establishment of the organization or its branch(es) in Viet Nam (if any) notarized or verified by a competent Vietnamese agency.

Where a foreign investor is an investment fund, the application should also include a copy of the fund's charter or its Memorandum of Understanding, the charter of the fund management company, financial statements for the last 2 consecutive years, and a summary of its targets and operations in Viet Nam.

All documents and forms listed above must be translated to Vietnamese, and the Vietnamese State Notary Public Office must notarize the translated version. In addition, foreign investors who wish to invest in unlisted securities must also register a Capital Contribution Account with SBV. Depository members will update the VSD on account opening and closing on a daily basis via the electronic linkage system or via hard copy by 4:00 p.m. The VSD will verify the provided information and send confirmation at 8:30 a.m., 11:30 a.m. and 4:30 p.m. via the electronic linkage system or email.

In case of custodian change, VSD will only process the update upon completion of assets transfer. The timeline to correct information discrepancies is 1 business day.

C. Substantial Shareholder Reporting Requirements

Disclosure requirements apply to investors holding more than 5% of the capital of a listed company, where investors will have to file a report to the respective regulators within 7 days from the date of settlement. If disclosure is not done within the stipulated time, the trading system will reject that particular trade when foreign ownership limit is reached.

These guidelines were first outlined in *Circular No. 38-2007-TT-BTC*²¹ issued by the MOF on 8 April 2007, and were further elaborated when *HOSE Decision No.59/QD-TTGDCCKHCM* was issued on 8 June 2007. This Decision reflects the

²¹ Ministry of Finance. 2007. *Circular No. 38/2007/TT-BTC* (Circular Guiding the Disclosure of Information on the Securities Market). http://moj.gov.vn/vbpq/en/Lists/Vn%20bn%20php%20lut/View_Detail.aspx?ItemID=3488

essence of *Circular No. 38/2007/TT-BTC* and provides a more detailed guideline for all of HOSE participants.

The key part that impacts foreign investors relates to substantial holding disclosure reporting, which is required each time the investor's holding crosses the 5% level. In addition, at each 1% increment above the 5% level, or when ownership falls below 5%, filing of disclosure reports is also required. This report should be filed with the regulators (HOSE) within 7 working days, and would then be made known to the public.

Foreign investors and/or affiliated persons who intend to hold up to 25% of the issuing company's paid-up capital, or are holding 25% of a listed company, should send a disclosure report to HOSE so that HOSE releases the disclosure and advises the listed company within 3 working days before the trade date.

D. Rules and Regulations related to Buying Debt Instruments (Investment in Debt Securities)

1. Unless otherwise stated in the prospectus, offer document, term sheet, or similar document, there is no restriction on the types of investors who are eligible for investing in particular debt instruments.
2. Foreign investors, whether institutional or retail, should, however, ascertain whether it is permitted under the law of their jurisdictions.
3. Foreign investors without a legal presence in Viet Nam are prohibited from investing in and trading of T-bills.

E. Investor Protection

1. The *Bankruptcy Law* and Its Application for Companies Operating in Financial Services

There are several measures to protect investors in accordance with the *Securities Law* (No. 70/2006/QH11), which took effect on 1 January 2007, and with various regulations applicable to trading activities and related issues. Based on the amended *Constitution of the Socialist Republic of Viet Nam*, *Bankruptcy Law No. 21/2004/QH-11* was issued on 15 June 2004 to regulate bankruptcy-related issues applicable to enterprises and cooperatives in Viet Nam. *Decision No. 114/2008/ND-CP* was published on 3 November 2008, became effective on 14 November 2008, and gives further guidance on several articles in the *Bankruptcy Law* and their application to companies operating in the insurance industry, securities services, and financial services. The guidance mainly covers the bankruptcy procedure required for bankrupt companies, including the procedure for bankruptcy document submission, payment recovery plan, asset dissolution, and bankruptcy announcement. The decision mentions the regulatory authorities—the MOF and the SSC—apart from the judge, being the two main bodies involved in the review of the bankruptcy process of companies. These regulatory bodies have the authority to require the enterprises to undertake the necessary steps to recover their payment capacity and financial condition or to further the bankruptcy procedure as needed.

An insurance company may be required to increase capital or execute reinsurance to recover its financial status. Meanwhile, a securities company may be required to transfer its rights and obligations to another securities company to fulfill its responsibilities to its customers in case its payment capability is at risk. Otherwise, the SSC must appoint an appropriate securities company to handle such incurred duties. Limitation and suspension of the company assets, the procedure for asset dissolution, and voiding transactions are also specified in the guidance.

Upon the decision to begin the bankruptcy procedure for a securities company, activities such as brokerage services or opening securities accounts are required to be terminated. Also, activities such as borrowing or transfer of ownership of shares or assets must obtain approval from the judge. Steps for asset dissolution for insurance companies, securities companies, and financial companies are also enumerated in the order, ranging from total auction of the company to an enterprise in the same industry to separate asset selling in case auction fails. The decision came into effect on 14 November 2008. For any offense in relation to the execution of this guidance, Article 93 of the *Bankruptcy Law* will be applied.

2. Settlement Assistance Fund

A settlement assistance fund has been set up for investor protection. A flat fee of VND120 million has to be paid by a broker or custodian at the time of admission as a participant. The fees are then put aside for investor protection purposes. Furthermore, participants have to contribute 0.01% of their annual turnover of the previous year, but not more than VND2.5 billion per annum to this fund. Moreover, a compulsory loan facility can be utilized whenever a depository member is temporarily short of liquidity for settlement, and the amount of shortage is more than VND25 billion; this loan facility agreement (signed with the designated clearing bank) should be in place before utilization. The interest rate is decided by the designated clearing bank on the borrowing date.

3. Other Provisions for Investor Protection

There are also stringent requirements and reporting to be filed with VSD when so requested. Companies have to make the filing within 5 days if so requested by the VSD. Brokerage firms have to execute investors' orders before their own orders.

F. Capital Contribution Account Report

Foreign investors are required to file annual and quarterly reports with the SBV on the cash movement in the investor's capital contribution account (CCA), as well as unlisted securities holdings and capital contribution to unlisted companies in Viet Nam. The report must contain the following information:

- (i) Full name, address, business type, CCA account number, commercial bank where the CCA is opened, and the number of the CCA approval letter;
- (ii) Balance in the CCA account at the beginning and the end of the quarter or year and movements during the period; and
- (iii) The total value of unlisted securities holdings, capital contribution, and other holdings.

Reporting deadline is on the fifth day of the next month for the quarterly report and 10 January for the annual report. Failure to comply with this reporting requirement might lead to the withdrawal of the CCA approval.

G. Securities Identification System

HOSE and HNX each maintain a local numbering system for the securities listed in their respective exchanges. The local code for fixed income is an eight-digit alphanumeric code. The local code for the securities investment funds that are currently listed in the market is a six-digit alphanumeric code.

In 2008, the SSC signed *Decision 388* on the implementation plan to issue International Securities Identification Number (ISIN) codes for Vietnamese securities. To date, ISIN codes have been issued for all listed securities, including equities and fixed income. Investors are given the option to use ISIN codes, rather than local codes, in their trade and settlement instructions.

H. Taxation Framework and Tax Requirements

In accordance with the newly issued *Personal Income Tax (PIT) Law, Decision No. 100/2008/ND-CP* dated 8 September 2008, and *Circular No. 84/2008/TT-BTC* dated 30 September 2008, retail investors (both resident and non-resident) are currently taxed on dividend, interest of bonds, capital gains, and certain securities. Table 2.2 illustrates the duties and taxes for fixed income.

Table 2.2 Duties and Taxes

	Fixed Income
Capital Gains Tax	N/A
Income tax on Sales Proceeds	0.10% of transaction value
Withholding Tax ^a	10%
Stamp Duty	0
Value Added Tax	0

^a The investors pays 10% of the interest received during each interest payment period. Previously, investors paid 0.10% withholding tax on the total face value of the bond plus the interest received.
Source: VBMA and Citibank.

Foreign institutional investors, including foreign investment funds which have no legal presence in Viet Nam, are subject to income tax on a deemed basis. The deemed income tax rate is 0.1% of the equity sales proceeds and sales of investment certificates for each transaction. For listed shares, the securities company (i.e., the brokers) is responsible for withholding, reporting, paying and finalizing the tax with the tax authorities on behalf of the customers. For non-listed shares, if the issuers authorize the brokers to manage the shareholder registrar and monitor the transfer procedures, the withholding and payment obligation also rests with the brokers. Otherwise, it will rest with the issuers.

Profits distributed by investment funds to both resident and non-resident institutional investors are subject to 20% withholding tax, except profits which are sourced from dividends and are already subject to corporate income tax for ordinary businesses. The investment fund management company is responsible for withholding, reporting and paying the tax on behalf of the investors. Interest earned by investors from investment in bonds, which are exempt from income tax in accordance with the current regulations, is not subject to income tax. In other cases, a 10% withholding tax would, in principle, apply to interest income from investment in bonds.

I. Tax Exemption Requirements for Non-Residents

Foreign institutional investors, including foreign investment funds, that have no legal presence in Viet Nam, are subject to income tax on a deemed basis. For listed securities, the securities company (i.e., the broker) is responsible for withholding, reporting, paying, and finalizing the tax with the tax authorities on behalf of the customers. For non-listed securities, if the issuers authorize the brokers to manage the shareholder registrar and monitor the transfer procedures, withholding and payment obligation also rests with the brokers. Otherwise, it will rest with the custodian banks.

J. Definition of Professional Investors in the Viet Nam Market

1. Item 11, Article 6 of *Securities Law No. 70/2006/QH11* defines institutional investors as “commercial banks, financial companies, financial leasing companies, insurance organizations, and securities trading organizations.”
2. There are no clear concepts of wholesale and retail in the Viet Nam bond market.
3. Before 1 July 2011, by the time of introducing a law amending the 2006 Law on Securities, the private placement (non-public offering) concept was not clearly defined in the laws and regulations in Viet Nam. Also, private placement (non-public offering) was not regulated in Viet Nam.
4. The concept of private placement (non-public offering) of securities (i.e., an arrangement for offering securities to less than 100 investors, not including institutional investors, without using the mass media or the internet) has now been introduced by the Amended Law. Private placement (non-public offering) is presented as the alternative to an ‘offer of securities to the public.’ The provisions of the Amended Law on private placement (non-public offering) will only apply to placements by public companies.

III. Trading of Bonds and Trading Market Infrastructure

A. Over-the-Counter Market Trading System of Bonds in Viet Nam

Figure 3.1 shows the over-the-counter (OTC) market trading system from a global custodian's point of view.

Figure 3.1 Over-the-Counter Market Transaction from a Global Custodian's Point of View

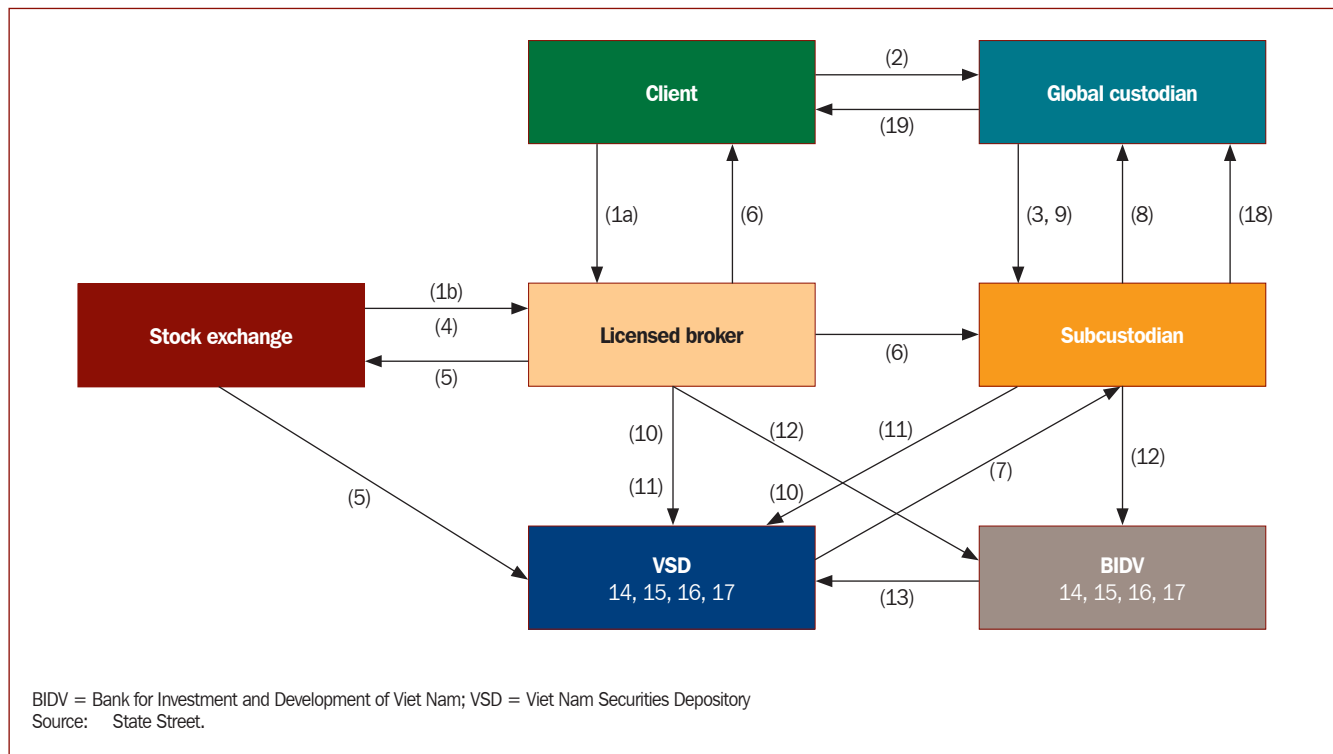

Trade Date -1 (all times are local)

Bond trading is normally executed via negotiation. Hence, trades are often agreed between counterparties before being entered into the stock exchange trading system.

- 1a. The client and counterparty agree on bond trade details directly or place the trade order with licensed brokers.
- 1b. Under current practice, brokers execute bond trades via negotiation directly with counterparty and input trades to the exchange, i.e., trades are executed before the trade date (TD), which is the date brokers enter the trades to the trading system.
2. The client sends settlement instructions to the global custodian by TD-1 at 4:00 p.m. Eastern Standard Time (EST).
3. The global custodian sends settlement instructions to the sub-custodian.

Trade Date

4. After checking cash and/or securities availability with the sub-custodian, the broker inputs the order into the stock exchange trading system for matching.
5. The stock exchange matches orders and issues confirmation of trade execution to the broker and reports trade details to the Vietnam Securities Depository (VSD).
6. The broker confirms trade details back to the client and the sub-custodian between 1:00 p.m. and 2:00 p.m.
7. VSD confirms the trade details to the sub-custodian between 2:00 p.m. and 4:00 p.m.
8. The sub-custodian provides trade details to State Street upon receipt of the bond trade confirmation from the broker and the VSD.
9. In case of mismatch, the sub-custodian requests the broker to provide evidence (e.g., trade order of the client) that the trade is correctly executed. If the broker can provide valid evidence, the trade must be settled in accordance with the regulation. The sub-custodian liaises with State Street to obtain the amended instruction. The global custodian sends the amended instruction to the sub-custodian by 7:00 p.m. on TD.

Trade Date +1

10. If the broker cannot provide valid evidence, the sub-custodian files a dispute to the VSD by 8:30 a.m. on TD+1 (SD). Depository participants must report error trades to the VSD by 8:30 a.m. on TD+1 (SD). It does not mean that the trade can be cancelled. Trade can only be cancelled when there is no solution, and the default party must bear all costs and/or losses. The party who makes the error should be responsible to settle the trade.
11. By 8:30 a.m., the sub-custodian or broker proposes a solution to the VSD for trade correction, if there is any error reported on trade date. In most cases, the broker will borrow securities from other participants or use their own portfolio to settle. Based on the proposal, VSD will re-allocate the securities and send the post-trade correction notification to the relevant participants.
12. Depository participants fund their cash settlement accounts at the Bank for Investment and Development of Vietnam (BIDV), the market's clearing bank, for their net cash obligation by 11:00 a.m.
13. BIDV checks the availability of funds in these accounts and reports to the VSD by 11:30 a.m.

14. From 1:00 p.m. to 2:00 p.m., BIDV transfers the cash to the net delivering depository participants' clearing and settlement cash accounts at the BIDV while VSD transfers the securities from the participants' omnibus clients' transaction accounts to the participants' clearing and settlement securities accounts at the VSD.
15. Between 2:00 p.m. and 2:30 p.m., BIDV transfers cash to VSD's cash settlement account at BIDV and confirms the fund movement to VSD. VSD transfers securities from all depository participants' clearing and settlement accounts to VSD's settlement account.
16. Between 2:30 p.m. and 2:45 p.m., BIDV transfers the cash balances from VSD's cash settlement account to the net receiving depository participants' clearing and settlement cash accounts at the BIDV and confirms to the VSD. VSD transfers securities from its settlement account to the depository participant's clearing and settlement accounts.
17. Between 2:45 p.m. and 3:00 p.m., BIDV transfers the cash balances from the depository participant's clearing and settlement cash accounts to the depository participants' cash settlement accounts and confirms with the VSD. VSD transfers the securities from depository participant's clearing and settlement accounts to the participants' omnibus clients' transaction accounts.
18. The sub-custodian confirms the settlement with the global custodian.
19. The global custodian provides confirmation to the client.

B. The Viet Nam Government Bond Market

Government bonds and T-bills (from 2012) are exclusively traded on HNX. Figure 3.2 illustrates the trading environment for government bonds and T-bills on HNX.

Figure 3.2. Trading Environment for Government Bonds and T-bills on HNX

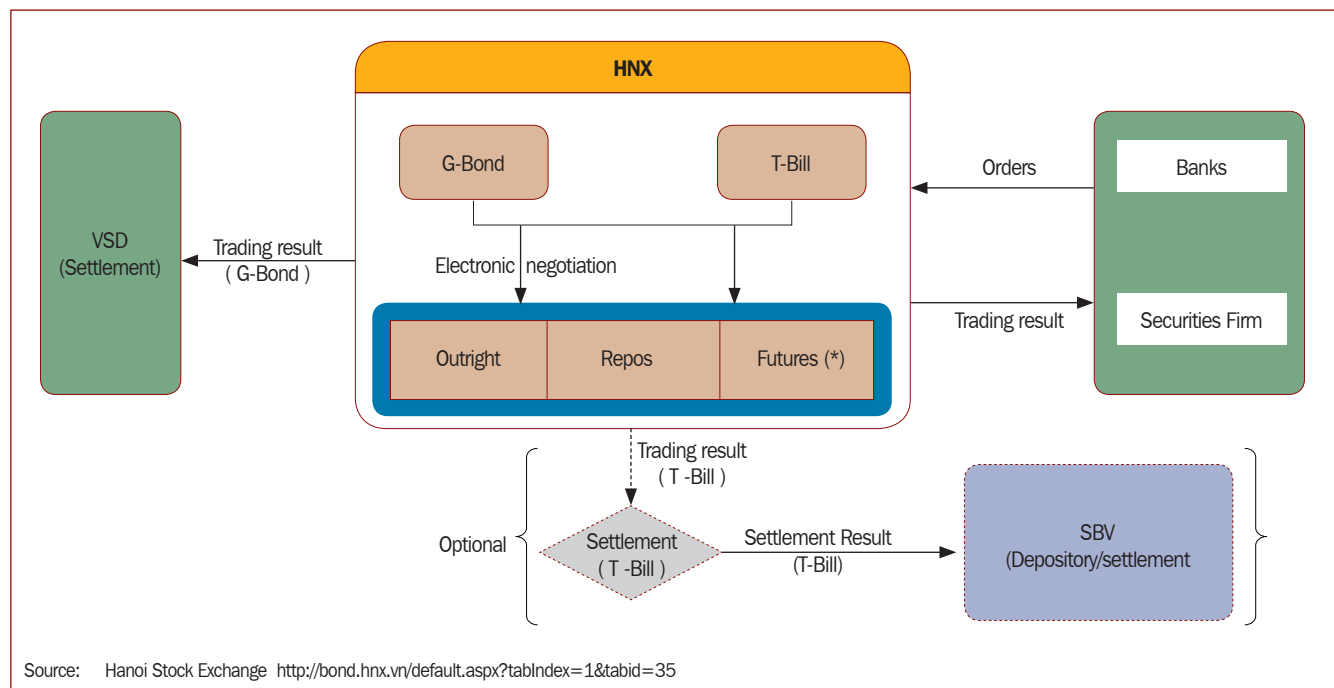

C. Bond Repurchase Market

Repo transactions for government bonds are available on the Hanoi Stock Exchange (HNX). Such repos are governed by Decision No. 46/2008/QD-BTC issued by the MOF on the rules for government bond trading management at the Hanoi Securities Trading Center (former name of HNX). In this context, the MOF also issued Circular No. 206/2009/TT-BTC dated 27 October 2009 instructing the accounting treatment for government bond repo transactions pursuant to Decision No. 46/2008/QD-BTC.

From August 2008, some local securities companies have restarted corporate bond repo services for selected clients and portfolios.

D. Viet Nam Bond Transaction Flow for Foreign Investors

Figure 3.3 Bond Transaction Flow for Foreign Investors

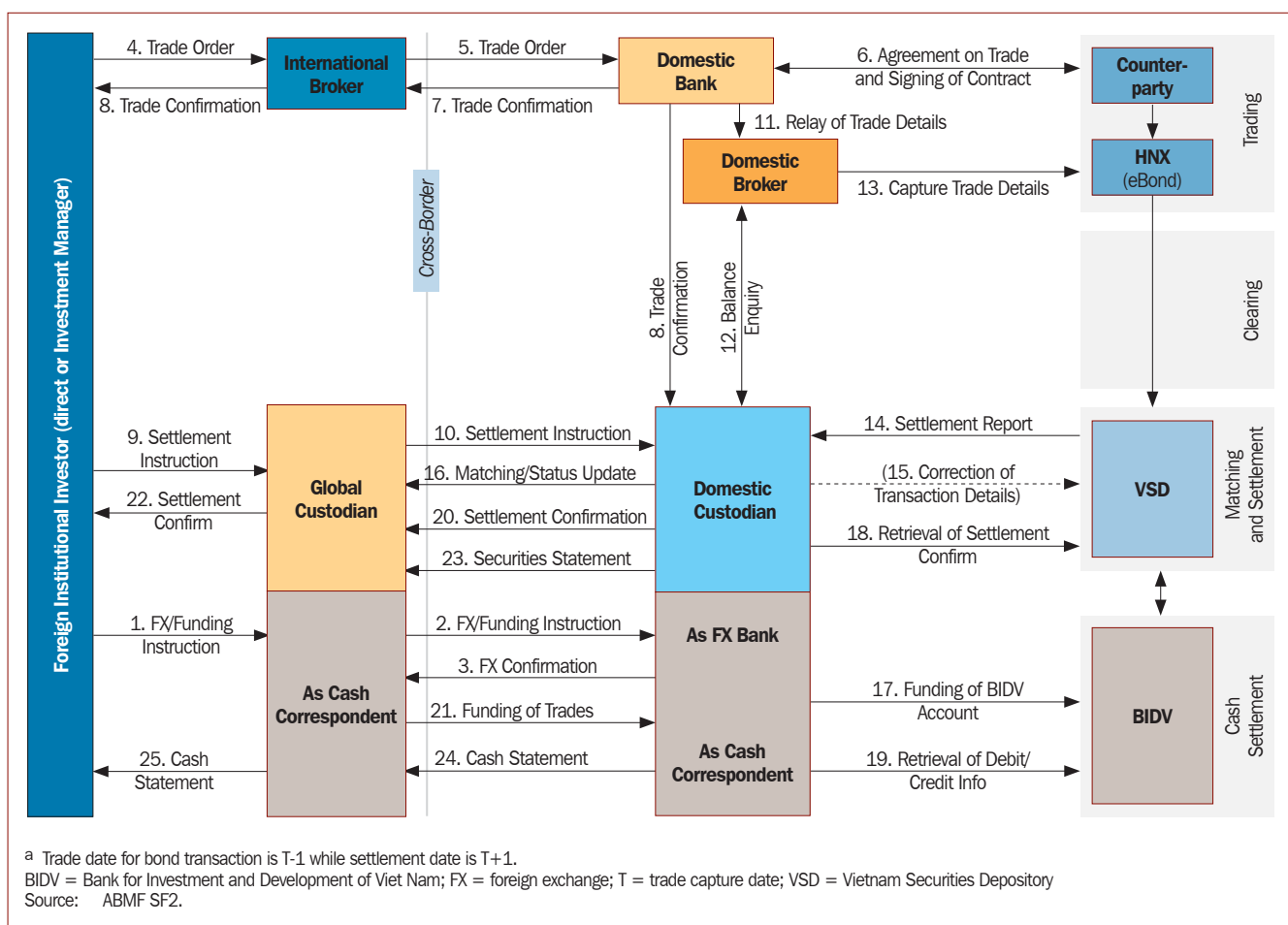

Below is the description of the steps of the OTC bond transaction flow for foreign investors:

1. The foreign institutional investor sends the foreign exchange (FX) or funding instruction to the global custodian for planned bond trades.
2. The global custodian sends FX or funding instruction to the domestic custodian to ensure timely availability of Vietnamese dong.
3. The domestic custodian sends FX confirmation to the global custodian.
4. The foreign institutional investor places the order with the international broker.
5. The international broker places the order, typically with a domestic bank.
6. The domestic broker or bank trade OTC with a counterparty via phone, and both parties sign a trade agreement (contract).
7. The domestic broker or bank sends trade confirmation to the international broker and to the domestic custodian.
8. The international broker sends trade confirmation to the foreign institutional investor.
9. The foreign institutional investor sends the securities settlement instruction to the global custodian.
10. The global custodian instructs domestic custodian on securities settlement details.
11. The domestic bank relays the trade details to the domestic broker (as HNX member) for trade capture.
12. The domestic broker checks available funds or bonds with the domestic custodian.
13. The domestic broker captures the trade details on HNX, typically via the eBond front-end system.
14. VSD provides the settlement report to the domestic custodian (at end of 'Trade Date').
15. Only in the event of a discrepancy does the domestic custodian need to contact VSD (hence dashed arrow).
16. The domestic custodian provides settlement or matching status to the global custodian.
17. The domestic custodian effects funding of BIDV account.
18. After the settlement deadline, the domestic custodian retrieves the settlement confirmation from VSD (hardcopy or online).
19. After the settlement deadline, the domestic custodian retrieves cash debit and/or credit confirmations from BIDV (hardcopy).
20. The domestic custodian sends the settlement confirmation to the global custodian.
21. The global custodian effects funding of the account with the domestic custodian, or into foreign currency nostro account (before end of day).
22. The global custodian sends the settlement confirmation to the foreign institutional investor.
23. The domestic custodian sends the securities statement to the global custodian.
24. The domestic custodian sends the debit and/or credit information in cash statement to the global custodian.
25. The global custodian sends the cash statement to the foreign institutional investor.

IV. Possible Impediments and Restrictions

This section discusses some of the weaknesses observed in the government bond market.

A. Lack of Liquidity in the Secondary Market

The liquidity of the government bond market needs to improve. The number of bond codes traded in 2010 accounted for 40% of the listed bond codes in the system. The market's turnover is about 35% of the whole market, which is relatively low.

B. Increase in Market's Listing Scale

In addition, the whole market's listing scale increased. The listing scale of each particular bond code was small, which resulted in difficulties for investors in choosing bond codes to trade. Meanwhile, market membership needs to be further diversified, and the standard of bond trading needs to be improved.

C. Imbalance in Bond Terms

An imbalance in bond terms issued on the primary market is also part of the market's weaknesses. While winning volumes of 2-, 3- and 5-year bonds were quite high, the numbers for 10- and 15-year bonds were relatively low.

D. Repo Market

Repo market is not operational enough.

E. Securities Lending

The current regulations do not permit securities lending in the Viet Nam market. However, there is supported lending that takes place among securities companies when a securities company is unable to meet its settlement obligations with the VSD.

F. Lack of Regulation Related to Private Placement Market

Regulation is currently lacking for the private placement market.

G. Market Entrance Requirements

Currently, requirements are burdensome for non-residents, one of which is the application for a securities trading code (STC). Before establishing an account and trading in listed and/or unlisted securities in Viet Nam, foreign investors must apply for an STC with the VSD. The VSD uses the STC to monitor foreign ownership limits in the equity market. According to local regulations, foreign investors are:

- (i) individuals with foreign nationalities residing in foreign laws and the branches of such organizations, including branches in Viet Nam;
- (ii) organizations established and operated under foreign laws and the branches of such organizations, including branches in Viet Nam;
- (iii) wholly foreign-owned organizations set up and operated under Vietnamese laws and the branches of such organizations;
- (iv) investment funds founded and operated under foreign laws, and 100% foreign-invested funds established and operated under Vietnamese laws; or
- (v) other cases as indicated in separate stipulation by the Prime Minister.

Applications for an STC must include documents, which will be forwarded to the VSD. The investor must complete VSD's Securities Trading Code Application Form for Offshore Foreign Institutional Investors to invest in Viet Nam's securities markets, which must be signed by an authorized signatory of the applicant's office. If the investor is under a fund-sub-fund structure when applying for an STC, the account must be named either:

- a. the name of the sub-fund, or
- b. name of the fund–name of the sub-fund.

The investor must provide supporting documents to prove the legal status of the applicant. Investors must also ensure that the names are consistent between supporting documents and they exactly match the name used on the application form. If the names do not match, documentation showing the change in name must also be submitted.²²

²² State Street. 2010. *The Guide to Custody in World Markets, Vietnam*. <insert place of publication>.

V. Description of the Securities Settlement System

A. Securities Settlement Infrastructure

Figure 5.1 Securities Settlement Infrastructure in Viet Nam

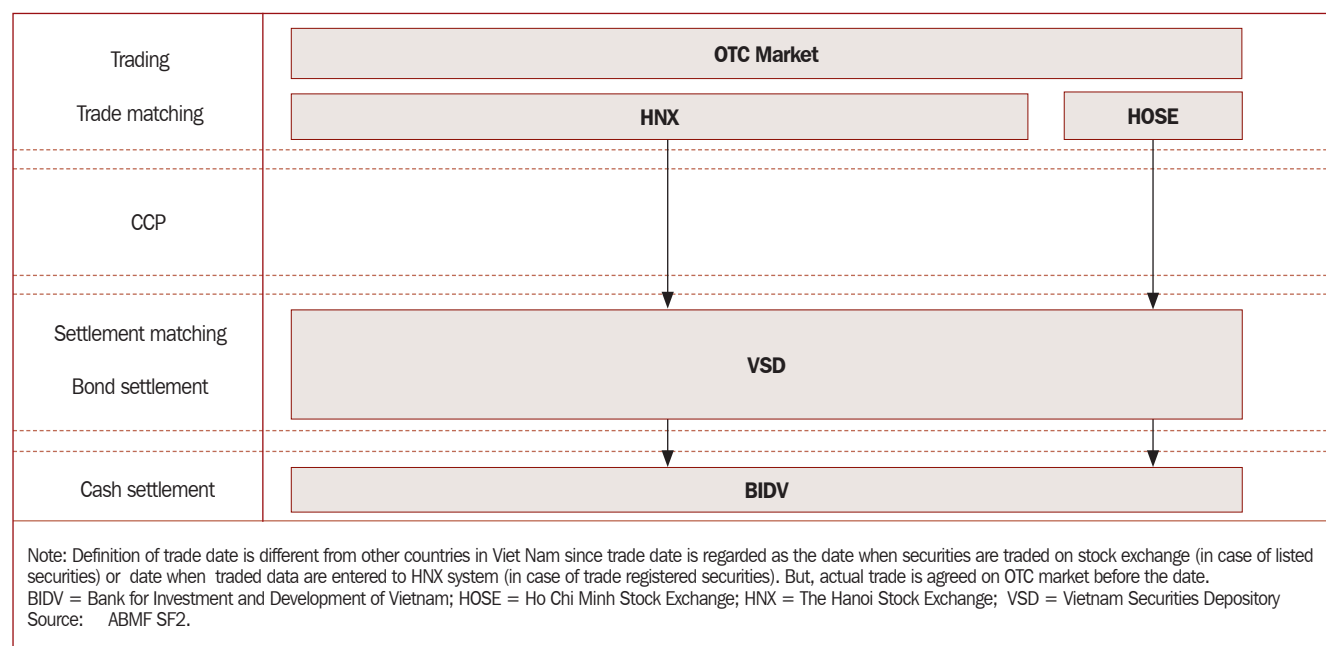

The following flowcharts (Figures 5.1) are intended to illustrate the bond transaction steps in the Vietnamese market, as seen between the buyer side and seller side of a bond transaction, and following through from the original trade negotiation to cash settlement. For easy reference, the individual steps indicated in Figures 5.1. are explained after the diagram.

Figure 5.2 Business Process Flow Chart of the Government Bond Market (Delivery versus Payment)

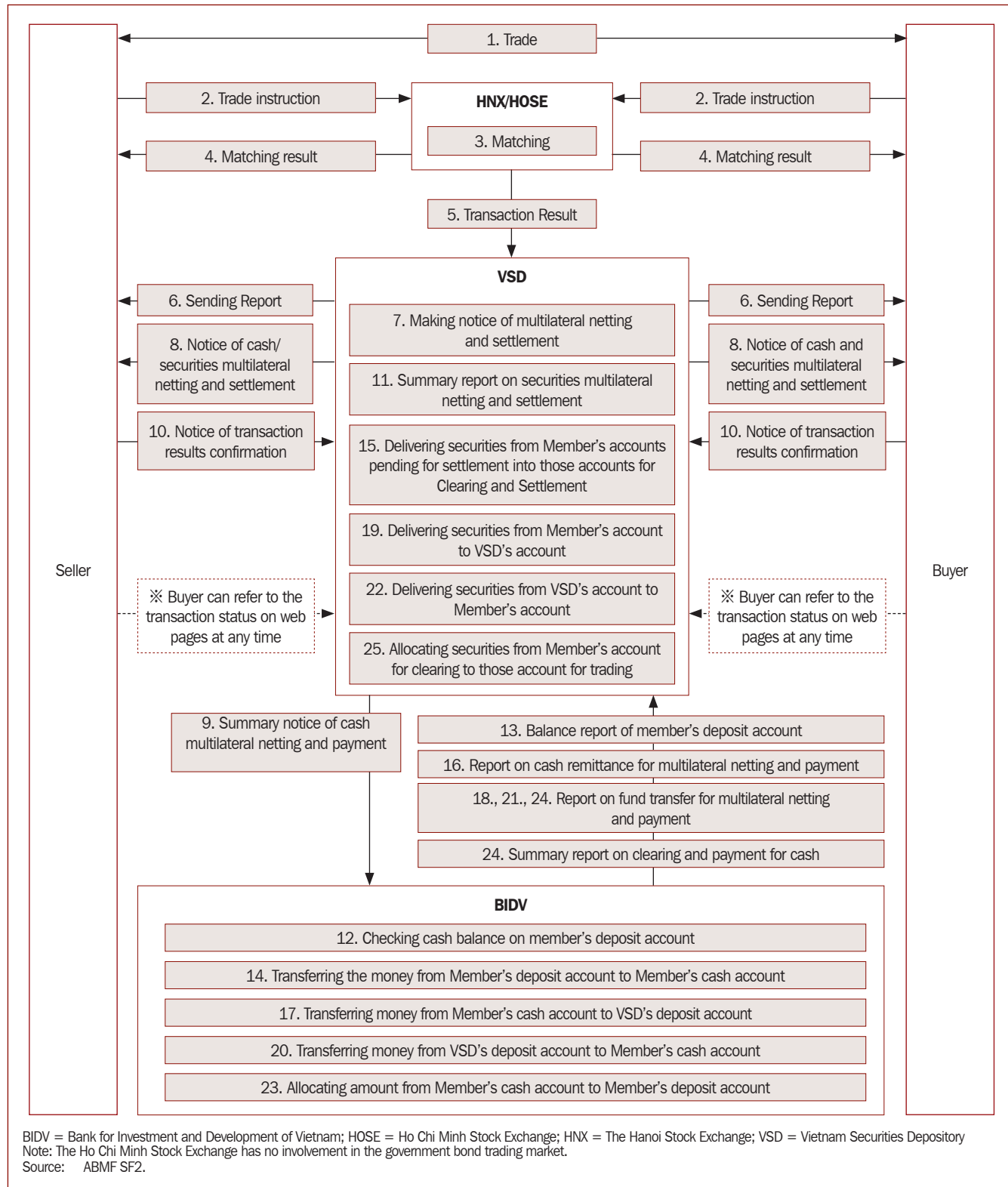

B. Settlement Cycle

The settlement cycle for government bonds is T+1.²³ On Trade Date (T), after the morning trading session, the Ho Chi Minh Stock Exchange (HOSE) or Hanoi Stock Exchange (HNX) processes all trades. At 3:30 p.m., custodian banks or securities firms receive the confirmed trade date and advice for settlement. Based on the confirmed settlement amount and number of bonds advices received from the HOSE or HNX on T+1 morning, the custodian bank debits the client's account and transfers the fund to its account with the designated bank to ensure that by the end of the morning clearing session, the settlement fund is transferred. A transfer made after the regulated settlement cycle cut-off time (T+1) by the custodian bank is considered a violation of the current settlement regulation.

For listed corporate bonds, the settlement cycle is T+3, the same as for the stock market. Unlisted corporate bonds settle as per the agreement between trading parties.

C. Settlement Method

Settlement of transactions in listed bonds is done on a book-entry basis by VSD. Bond transactions of VSD participants are netted by bond issue and the net amounts are debited from or credited to participants' securities accounts. Cash is settled on a net basis through the participants' accounts at BIDV.

Settlement for unlisted bonds is effected as a physical transfer of certificates between buyer and seller, or their intermediaries. Here, both securities and cash or cash instruments, such as cheques, are exchanged at the place of settlement, typically a bank counter.

D. Definition of Clearing and Settlement

1. Securities Clearing

According to Items 7 and 8 of Article 2 of *Decision No. 87/2007/QDBTC* on registration, depository, clearing, and settlement of securities, securities' clearing includes bilateral clearing and multilateral clearing. Bilateral clearing means the method of clearing securities transactions which have been matched during the same day between any two trading parties with respect to one type of securities to determine the net sum and securities which must be settled by both parties. Multilateral clearing means the method of clearing securities transactions which have been matched during the same day between all trading parties with respect to one type of securities to determine the net sum and securities which must be settled by all parties.

2. Securities Settlement

Securities delivery is made by the Vietnam Securities Depository (VSD) while cash payment is made by the settlement bank. The delivery-versus-payment (DVP)

²³ In the Vietnamese bond market, Trade Date is understood to be the date on which a bond trade is captured in the HNX bond trading platform; the trade agreement between counterparties may precede the Trade Date. The settlement cycle for bonds is calculated from Trade Date, as is international practice.

principle is to be observed. Settlement for securities transactions at stock exchanges is based on multi-netting results with T+1 settlement cycle for bonds. VSD organizes the settlement for securities trading transactions at stock exchanges as follows:

- (a) For securities, the VSD clears transactions and transfers securities via its account and depository accounts of selling and buying members opened at VSD.
- (b) For cash, the VSD clears cash for each member at each market. Concurrently, the settlement bank (the Bank for Investment and Development of Vietnam [BIDV]) makes payment for securities transactions via cash accounts of members and of VSD opened at the Bank.

According to Article 32 of *Decision No. 87/2007/QĐ-BTC*, the VSD settles securities based on bilateral and multilateral clearing results, and then settles each transaction for listed and unlisted securities under its purview. The settlement bank effects payment orders according to cash clearing results sent by the VSD. Cash and securities settlement are the last post-trade activities to complete securities transactions, i.e., both parties fulfill their obligations and based on cash and securities clearing results, the seller delivers the securities and the buyer delivers payment.

Article 3 of the VSD guideline on securities clearing and settlement stipulates that the VSD shall clear securities and funds, and settle securities transactions in accordance with the principles prescribed in Article 32 and 33 of the *Guidelines on Securities Registration, Depository, Clearing and Settlement* issued with *Decision No. 87/2007/QĐ-BTC* dated 22 October 2007 by the Minister of Finance, and Article 11 of *Circular No. 43/2010/TT-BTC* dated 25 March 2010 by the Minister of Finance on amending and supplementing the *Guidelines on Securities Registration, Depository, Clearing and Settlement* issued with *Decision No. 87/2007/QĐ-BTC* dated 22 October 2007 by the Minister of Finance.

Cash clearing shall be made for each member by each market. For transactions of stocks, fund certificates, and corporate bonds listed and registered for trading on stock exchanges, the cash of each member shall be transferred on the basis that VSD shall clear the amount receivable and the amount payable for transactions executed at the same time and with the same settlement method at the stock exchanges. Transaction settlement shall be made based on the DVP principle.

The VSD clears settlement obligations (receivables and payables) towards transactions of listed stocks, fund certificates, and corporate bonds with the same payment time and manner at two stock exchanges to calculate settlement obligations to receive or to pay through each depository member.²⁴

²⁴ Citibank. 2009. "Domestic Custody Services," *Market Guide Vietnam*. Hong Kong, p. 17.

VI. Cost and Charging Methods

Fees are determined under a mutual agreement between securities companies, investment management companies, and its customers. The applicable fees are based on *Circular No. 38/2011/TT-BTC* dated 16 March 2011. These are shown in Table 6.1.

Table 6.1 Fees in the Viet Nam Bond Market

Particulars	Percentage of Fees/Commission
Brokerage Commission	- Shares, Fund Certificates: from 0.15% to 0.5% of the trading value from 0.02% to 0.1% of the trading value
Underwriting Fees	from 0.5% to 2% of the underwritten sum.
Investment Consultancy Fees	Percentage decided by mutual agreement
Fund Management Fees	Not more than 2% of the asset value
Portfolio Management Fees	Not more than 2% of the asset value
Domestic Fund Administration	Not more than 0.15% of assets value under administration
Custodian Fees	As prescribed by the Vietnam Securities Depository

Source: Deutsche Bank AG Domestic Custody Services. 2009. *Market Guide Vietnam*.

The new fee schedule applicable on the stock exchanges and the Vietnam Securities Depository (VSD) is in accordance with *Circular No. 27/2010/TT-BTC* dated 26 February 2010. The fee schedule, according to fee type and classification, is shown in Tables 6.2 and 6.3.

Table 6.2 New Fees Schedule

Fee Type	Fee Level (in VND)
Terminal Utilization Fee ^a	20 million/per terminal/per annum
Transaction Fees	
Shares, Fund Certificates	VND 5/lot/month (1 lot= 10 securities)
Bonds	VND 2/lot/month
Annual Listing Management Fee	
Listing Value < VND100 billion	15 million VND
Listing Value >VND 100 billion <VND 500 billion	20 million VND

continued on next page

Table 6.2 continuation

Fee Type	Fee Level (in VND)
Listing Value > VND 500 billion	20 million + 0.001% of listing value but not more than 50,000,000
Custody Fees	
Securities Custody	VND2 per lot per month ^b
Securities Transfer	VND 5/lot but not more than VND 500,000 per transfer.
^a The terminal used by the dealer on each trading floor. ^b A lot is equivalent to 10 securities. Source: Deutsche Bank AG Domestic Custody Services, 2009. <i>Market Guide Vietnam</i> . Vietnam Securities Depository	

Table 6.3 Fees Schedule according to Classification

Classifications	Fee
Exchange Fee	
Depository Fee	
Shares, Fund certificates	VND5/lot/month
Bonds	VND2/lot/month
Broker Fee	0.15%
Transaction Fee (Listed and UPCoM)	0.03% transaction amount
Transaction Fee (Bond Repo)	
Up to 2 weeks	0.005%
Over 2 weeks	0.0075%
Transfer Fee (for both transactions and change of custodian) ^a	VND5 per lot (maximum of VND500,000 per transfer)
Trade Error Correction Fee (paid by error party)	VND500,000 per transactions
Ownership Transfer Fee on off-exchange transactions for listed securities	0.1%
^a Previously, transfer upon custodian change is free. There are no stamp duty and registration costs. Source: Deutsche Bank AG Domestic Custody Services, 2009. <i>Market Guide Vietnam</i> . Vietnam Securities Depository	

VII. Market Size and Statistics

A. Size of Local Currency Bond Market in US Dollars (Local Sources)

Table 7.1 Size of Local Currency Bond Market (Local Sources) (\$ billion)

Date	Government	Corporate	Total
Mar-00	0.01	0	0.01
Jun-00	0.01	0	0.01
Sep-00	0.09	0	0.09
Dec-00	0.09	0	0.09
Mar-01	0.09	0	0.09
Jun-01	0.09	0	0.09
Sep-01	0.15	0	0.15
Dec-01	0.19	0	0.19
Mar-02	0.20	0	0.20
Jun-02	0.22	0	0.22
Sep-02	0.24	0	0.24
Dec-02	0.28	0	0.28
Mar-03	0.31	0	0.31
Jun-03	0.39	0	0.39
Sep-03	0.57	0	0.57
Dec-03	0.85	0	0.85
Mar-04	1.07	0	1.07
Jun-04	1.16	0	1.16
Sep-04	1.43	0	1.43
Dec-04	1.59	0	1.59
Mar-05	1.74	0	1.74
Jun-05	1.97	0	1.97
Sep-05	2.20	0	2.20
Dec-05	2.64	0	2.64
Mar-06	3.05	0	3.05
Jun-06	3.70	0	3.70
Sep-06	4.38	0.01	4.39
Dec-06	5.02	0.01	5.03

continued on next page

Table 7.1 continuation

Date	Government	Corporate	Total
Mar-07	6.71	0.01	6.72
Jun-07	7.53	0.01	7.54
Sep-07	8.04	0.26	8.30
Dec-07	9.55	0.33	9.89
Mar-08	12.00	0.41	12.42
Jun-08	11.48	0.57	12.06
Sep-08	12.23	0.58	12.81
Dec-08	12.74	0.55	13.29
Mar-09	11.24	0.54	11.79
Jun-09	11.54	0.52	12.07
Sep-09	11.84	0.86	12.7
Dec-09	10.9	1.06	11.97
Mar-10	10.75	1.14	11.89
Jun-10	13.88	1.45	15.32
Sep-10	13.61	1.23	14.84
Dec-10	13.79	1.82	15.61
Mar-11	14.17	1.67	15.83
Jun-11	15.28	1.59	16.87

Source: AsianBondsOnline. <http://asianbondsonline.adb.org/vietnam/data.php>

B. Size of Local Currency Bond Market in Percentage of Gross Domestic Product (Local Sources)

Table 7.2 Size of Local Currency Bond Market (Local Sources)
(\$ billion, % GDP)

Date	Govt (% GDP)	Corp (% GDP)	Total (% GDP)	Govt (\$ billions)	Corp (\$ billions)	Total (\$ billions)
Mar-00	0	0	0	0.01	0	0.01
Jun-00	0	0	0	0.01	0	0.01
Sep-00	0.3	0	0.3	0.09	0	0.09
Dec-00	0.3	0	0.3	0.09	0	0.09
Mar-01	0.3	0	0.3	0.09	0	0.09
Jun-01	0.3	0	0.3	0.09	0	0.09
Sep-01	0.5	0	0.5	0.15	0	0.15
Dec-01	0.6	0	0.6	0.19	0	0.19
Mar-02	0.6	0	0.6	0.20	0	0.20
Jun-02	0.7	0	0.7	0.22	0	0.22
Sep-02	0.7	0	0.7	0.24	0	0.24
Dec-02	0.8	0	0.8	0.28	0	0.28
Mar-03	0.9	0	0.9	0.31	0	0.31
Jun-03	1.1	0	1.1	0.39	0	0.39
Sep-03	1.5	0	1.5	0.57	0	0.57
Dec-03	2.2	0	2.2	0.85	0	0.85
Mar-04	2.7	0	2.7	1.07	0	1.07

continued on next page

Table 7.2 continuation

Date	Govt (% GDP)	Corp (% GDP)	Total (% GDP)	Govt (\$ billions)	Corp (\$ billions)	Total (\$ billions)
Jun-04	2.8	0	2.8	1.16	0	1.16
Sep-04	3.3	0	3.3	1.43	0	1.43
Dec-04	3.5	0	3.5	1.59	0	1.59
Mar-05	3.7	0	3.7	1.74	0	1.74
Jun-05	4.0	0	4.0	1.97	0	1.97
Sep-05	4.3	0	4.3	2.20	0	2.20
Dec-05	5.0	0	5.0	2.64	0	2.64
Mar-06	5.7	0	5.7	3.05	0	3.05
Jun-06	6.7	0	6.7	3.70	0	3.70
Sep-06	7.6	0	7.6	4.38	0.01	4.39
Dec-06	8.3	0	8.3	5.02	0.01	5.03
Mar-07	10.7	0	10.8	6.71	0.01	6.72
Jun-07	11.7	0	11.7	7.53	0.01	7.54
Sep-07	11.9	0.4	12.3	8.04	0.26	8.30
Dec-07	13.4	0.5	13.8	9.55	0.33	9.89
Mar-08	16.3	0.6	16.9	12.00	0.41	12.42
Jun-08	15.2	0.8	15.9	11.48	0.57	12.06
Sep-08	14.9	0.7	15.6	12.23	0.58	12.81
Dec-08	15.0	0.7	15.6	12.74	0.55	13.29
Mar-09	13.0	0.6	13.6	11.24	0.54	11.79
Jun-09	12.9	0.6	13.5	11.54	0.52	12.07
Sep-09	13.0	0.9	13.9	11.84	0.86	12.70
Dec-09	12.2	1.2	13.3	10.90	1.06	11.97
Mar-10	12.0	1.3	13.3	10.75	1.14	11.89
Jun-10	14.9	1.5	16.4	13.88	1.45	15.32
Sep-10	14.2	1.3	15.5	13.61	1.23	14.84
Dec-10	13.6	1.8	15.4	13.79	1.82	15.61
Mar-11	14.4	1.7	16.1	14.17	1.67	15.83
Jun-11	14.3	1.5	15.8	15.28	1.59	16.87

Source: AsianBondsOnline. http://asianbondsonline.adb.org/vietnam/data/bondmarket.php?code=LCY_in_GDP_Local.

C. Foreign Currency Bonds (Bank of International Settlement)

Table 7.3 Foreign Currency Bonds (BIS) (\$ billion)

Date	Foreign Currency-Denominated Bonds
Dec-95	0
Dec-96	0
Dec-97	0
Dec-98	0.5
Dec-99	0.5
Dec-00	0.5
Dec-01	0.5
Dec-02	1.0
Dec-03	1.0

continued on next page

Table 7.3 continuation

Date	Foreign Currency-Denominated Bonds
Mar-04	1.0
Jun-04	1.0
Sep-04	1.0
Dec-04	1.0
Mar-05	1.0
Jun-05	1.0
Sep-05	1.0
Dec-05	1.8
Mar-06	1.8
Jun-06	1.8
Sep-06	1.7
Dec-06	1.7
Mar-07	1.7
Jun-07	1.9
Sep-07	1.9
Dec-07	1.9
Mar-08	1.9
Jun-08	1.9
Sep-08	1.9
Dec-08	1.9
Mar-09	2.0
Jun-09	2.0
Sep-09	1.9
Dec-09	2.0
Mar-10	2.9
Jun-10	2.9
Sep-10	2.9
Dec-10	2.9
Mar-11	2.9

Source: AsianBondsOnline. http://asianbondsonline.adb.org/vietnam/data/bondmarket.php?code=FCY_in_USD

D. Foreign Currency Bonds to Gross Domestic Product Ratio

Table 7.4 Foreign Currency Bonds to GDP Ratio (\$ billion)

Date	as % of GDP	Foreign Currency-Denominated Bonds	GDP
Dec-95	0	0	20.8
Dec-96	0	0	24.4
Dec-97	0	0	25.5
Dec-98	2.1	0.5	26.0
Dec-99	1.9	0.5	28.5
Dec-00	1.8	0.5	30.4
Dec-01	1.7	0.5	31.9
Dec-02	3.0	1.0	34.8

continued on next page

Table 7.4 continuation

Date	as % of GDP	Foreign Currency-Denominated Bonds	GDP
Dec-03	2.7	1.0	39.2
Mar-04	2.6	1.0	39.9
Jun-04	2.5	1.0	41.5
Sep-04	2.4	1.0	42.6
Dec-04	2.3	1.0	45.4
Mar-05	2.2	1.0	46.9
Jun-05	2.1	1.0	49.0
Sep-05	2.0	1.0	50.9
Dec-05	3.4	1.8	52.7
Mar-06	3.3	1.8	54.0
Jun-06	3.2	1.8	55.4
Sep-06	3.0	1.7	57.7
Dec-06	2.9	1.7	60.7
Mar-07	2.8	1.7	62.5
Jun-07	3.0	1.9	64.5
Sep-07	2.8	1.9	67.6
Dec-07	2.7	1.9	71.4
Mar-08	2.6	1.9	73.7
Jun-08	2.5	1.9	75.8
Sep-08	2.3	1.9	82.1
Dec-08	2.2	1.9	84.9
Mar-09	2.3	2.0	86.6
Jun-09	2.2	2.0	89.4
Sep-09	2.1	1.9	91.1
Dec-09	2.3	2.0	89.7
Mar-10	3.3	2.9	89.7
Jun-10	3.1	2.9	93.4
Sep-10	3.0	2.9	95.7
Dec-10	2.9	2.9	101.6
Mar-11	2.9	2.9	98.6

Source: AsianBondsOnline. http://asianbondsonline.adb.org/vietnam/data/bondmarket.php?code=FCY_in_GDP

E. FCY Bonds Outstanding (Local Sources)

Table 7.5 Foreign Currency Bonds Outstanding (Local Sources) (\$ billion)

Date	Government	Banks and Financial Institutions	Other Corporates	Total Foreign Currency
Mar-00	0.39	0	0	0.39
Jun-00	0.39	0	0	0.39
Sep-00	0.39	0	0	0.39
Dec-00	0.39	0	0	0.39
Mar-01	0.39	0	0	0.39
Jun-01	0.39	0	0	0.39
Sep-01	0.39	0	0	0.39
Dec-01	0.39	0	0	0.39
Mar-02	0.39	0	0	0.39

continued on next page

Table 7.5 continuation

Date	Government	Banks and Financial Institutions	Other Corporates	Total Foreign Currency
Jun-02	0.39	0	0	0.39
Sep-02	0.39	0	0	0.39
Dec-02	0.39	0	0	0.39
Mar-03	0.39	0	0	0.39
Jun-03	0.39	0	0	0.39
Sep-03	0.39	0	0	0.39
Dec-03	0.39	0	0	0.39
Mar-04	0.39	0	0	0.39
Jun-04	0.39	0	0	0.39
Sep-04	0.39	0	0	0.39
Dec-04	0.39	0	0	0.39
Mar-05	0.39	0	0	0.39
Jun-05	0.39	0	0	0.39
Sep-05	0.39	0	0	0.39
Dec-05	1.14	0	0	1.14
Mar-06	1.14	0	0	1.14
Jun-06	1.14	0	0	1.14
Sep-06	1.14	0	0	1.14
Dec-06	1.14	0	0	1.14
Mar-07	1.14	0	0	1.14
Jun-07	1.14	0	0	1.14
Sep-07	1.14	0	0	1.14
Dec-07	1.14	0	0	1.14
Mar-08	1.14	0	0	1.14
Jun-08	1.14	0	0	1.14
Sep-08	1.14	0	0	1.14
Dec-08	1.14	0	0	1.14
Mar-09	1.37	0	0	1.37
Jun-09	1.37	0	0	1.37
Sep-09	1.57	0	0	1.57
Dec-09	1.77	0	0.07	1.85
Mar-10	2.67	0	0.07	2.75
Jun-10	2.62	0	0.07	2.70
Sep-10	2.57	0	0.07	2.65
Dec-10	2.42	0	0.07	2.49
Mar-11	2.33	0	0.04	2.36

Source: AsianBondsOnline. http://asianbondsonline.adb.org/vietnam/data/bondmarket.php?code=FCY_Bonds_Outstanding

F. Issuance Volume of Local Currency Bond Market in US Dollars

Table 7.6 Issuance Volume of Local Currency Bond Market (\$ billion)

Date	Govt	Corp	Total
Mar-00	0.0059	0	0.0059
Jun-00	0.0053	0	0.0053
Sep-00	0.0774	0	0.0774
Dec-00	0	0	0
Mar-01	0	0	0

continued on next page

Table 7.6 continuation

Date	Govt	Corp	Total
Jun-01	0.0033	0	0.0033
Sep-01	0.0660	0	0.0660
Dec-01	0.0393	0	0.0393
Mar-02	0.0057	0	0.0057
Jun-02	0.0256	0	0.0256
Sep-02	0.0163	0	0.0163
Dec-02	0.0477	0	0.0477
Mar-03	0.0281	0	0.0281
Jun-03	0.0823	0	0.0823
Sep-03	0.1848	0	0.1848
Dec-03	0.2793	0	0.2793
Mar-04	0.2284	0	0.2284
Jun-04	0.0847	0	0.0847
Sep-04	0.2704	0	0.2704
Dec-04	0.1667	0	0.1667
Mar-05	0.1613	0	0.1613
Jun-05	0.2300	0	0.2300
Sep-05	0.3213	0	0.3213
Dec-05	0.4582	0	0.4582
Mar-06	0.4360	0	0.4360
Jun-06	0.6701	0	0.6701
Sep-06	0.7634	0.0082	0.7716
Dec-06	0.6780	0	0.6780
Mar-07	1.6854	0	1.6854
Jun-07	0.8742	0	0.8742
Sep-07	0.5007	0.2487	0.7494
Dec-07	1.5146	0.0749	1.5895
Mar-08	2.5081	0.0838	2.5919
Jun-08	0.0119	0.1781	0.1900
Sep-08	0.7636	0	0.7636
Dec-08	1.4060	0	1.4060
Mar-09	0.1629	0	0.1629
Jun-09	0.4163	0.0562	0.4725
Sep-09	0.6655	0.3419	1.0074
Dec-09	0.2584	0.2354	0.4938
Mar-10	1.4120	0.1096	1.5216
Jun-10	3.3205	0.3068	3.6273
Sep-10	0.3438	0.1001	0.4438
Dec-10	0.4884	0.0872	0.5755
Mar-11	2.1528	0.0122	2.1650
Jun-11	1.1326	0	1.1326

Source: AsiaBondsOnline. http://asianbondsonline.adb.org/vietnam/data/bondmarket.php?code=Issuance_Volume_LCY

VIII. Presence of an Islamic Finance (Islamic Bond [*Sukuk*] Market)

There is no Islamic finance market in Viet Nam.

IX. History of Capital Market Development

The development of the regulatory framework for the capital market in Viet Nam can be traced through the following decisions:

Table 9.1 Evolution of Capital Market Regulatory Framework in Viet Nam

Month/Year	Event	Remarks
November 1993	The Capital Market Development Board under the State Bank of Vietnam	Governor's Decision No. 207/QD-TCCB
September 1994	The Board for Drafting the Decree-Law of Securities Market	
June 1995	The Board for the Preparation of the Securities Market	PM's Decision No. 361/QDTTg
28 November 1996	<p>Establishment of The State Securities Commission (SSC). Under the Government's Decree No. 75/CP, the SSC was set up as a governmental agency charged with the mission of organizing and regulating the operations in the field of securities and securities market. The establishment of this securities regulator prior to the actual functioning of the securities market itself proved to be an approach consistent with the general directives of building and developing the securities market in Viet Nam, and this determined the birth of the securities market over 3 years later. SSC plays a decisive role in preparing the necessary conditions for the setup of the securities market. At the same time, it is its major job to organize and regulate the securities and securities market operations, with the focal mission of facilitating the process of fund mobilization for development investment; ensuring the orderly, safe, transparent, equitable and efficient operation of the securities market; and no less importantly, protecting investors' legitimate rights and interests.</p> <p>SSC is a governmental agency having full and complete functions, duties and powers of a securities regulator, exercising its supervisory and regulatory operations over the securities industry, helping push forward the development of the securities market, and protecting investors legitimate rights and interests. At the same time, the SSC is also the regulator of all public services in the securities industry.</p> <p>Therefore, the SSC was assigned with duties and powers as follows:</p> <p>2.1.1. Drafting legal documents on securities and securities markets and submitting them to the competent authorities for ratification, and organizing the implementation of these documents once passed;</p> <p>2.1.2. Collaborating with other ministries and industries to plan the building and development of the securities markets;</p> <p>2.1.3. Granting, suspending, or revoking various kinds of licenses of such market participants as securities houses, securities advisory companies, securities investment funds, fund management companies, issuing and listed organizations, and other securities-related organizations;</p> <p>2.1.4. Permitting the establishment of service-providing and ancillary organizations, and regulating them in compliance with applicable laws and regulations;</p>	Decree No. 75/CP

continued on next page

Table 9.1 continuation

Month/Year	Event	Remarks
	<p>2.1.5. Submitting to the Prime Minister for the establishment, suspension or dissolution of the Stock Exchange;</p> <p>2.1.6. Examining and supervising the operations of the Stock Exchange and other organizations related to securities issuance, trading and services;</p> <p>2.1.7. Promulgating regulations and requirements on issuance and listing of securities and on information of securities transactions; discussing with the Ministry of Finance on fees and charges related to securities issuance and trading;</p> <p>2.1.8. Providing specialized training and retaining to securities regulatory staff and practitioners;</p> <p>2.1.9. Cooperating with international organizations and other countries in the field of securities and securities markets in compliance with applicable laws and the Governments guidelines;</p> <p>2.1.10. Collaborating with other competent authorities in applying necessary measures to ensure the efficient and lawful operations of the securities markets;</p> <p>2.1.11. Managing its human resources and infrastructure in compliance with the Governments regulations; and</p> <p>2.1.12. Exercising other duties as assigned by the Prime Minister.</p> <p>In accordance with this Decree, the organizational apparatus of the SSC was initially comprised of 8 units and divisions, namely:</p> <ul style="list-style-type: none"> - The Securities Market Development Department; - The Securities Issuance Management Department; - The Securities Business Management Department; - The International Relations Department; - The Personnel and Training Department; - The Inspection Department; - The Office of the SSC; - The SSCs Representative Office in Ho Chi Minh City. 	
05 December 1997	In order for the SSC to exercise its new tasks and duties, the Prime Minister issued Decision No. 1038/1997/QD-TTg on the establishment of the Securities Science Research and Training Center.	Decision No. 1038/1997/QD-TTg
11 July 1998	<p>The decision to set up Securities Trading Centers (STCs), one in Ha Noi and the other in Ho Chi Minh City.</p> <p>Most importantly on this year, the Prime Minister's Decision No. 127/1998/QD-TTg pinpointed the coming into being of the two STCs, one in Ha Noi and the other in Ho Chi Minh City. In agreement with the Government's Board of Organization and Personnel (now the Ministry of Home Affairs), the Chairman of the SSC made his decision to set up three other units: the Division of Legal Affairs, the Division of Information Technology, and the Securities Review.</p> <p>The Decree No. 75 of 1996 specified that the leadership of the SSC consisted of the Chairman and Vice-Chairmen, who are appointed by the Prime Minister, and other Ex-officio commissioners, who are Vice-Ministers of relevant ministries, such as Planning and Investment, Justice, Finance, and the State Bank of Vietnam.</p> <p>This model of leadership is suitable for specific conditions and situations in Viet Nam then, and, at the same time, helped bring into full play the comprehensive strengths of relevant authorities in regulating the new and sophisticated industry: securities and securities markets.</p>	PM's Decision No. 127/1998/QD-TTg
19 September 1998	The establishment of the Finance and Accounting Department.	Decision No. 179/1998/QD-TTg
26 May 2000	Government's Decree on the organization and operation of the Securities Inspection Department of the State Securities Commission	17/2000/ND-CP
July 2000	The Ho Chi Minh City Securities Trading Center (HOSTC)	
5 August 2003	The Prime Minister's Decision on the approval of the Strategy for the Development of Vietnam's Securities Market up to year 2010	PM's Decision No. 163/2003/QD-TTg
8 or 12 August 2003	<p>Government's Decree on the functions, duties, powers and organizational structure of the State Securities Commission</p> <p>The reinforcement of the SSC's duties and powers "Decree on Functions, Tasks, Rights and Organization Structure of State Securities Commission."</p> <p>To further consolidate the organizational apparatus of the SSC, the Government promulgated Decree No. 90/2003/ND-CP dated 8 August 2003 on the functions, duties, powers and organizational structure of the SSC, as a replacement of Decree No. 75 of 1995.</p> <p>The SSCs organizational chart, in accordance with Decree No. 90, is as follows:</p>	Decree No. 90/2003/ND-CP

continued on next page

Table 9.1 continuation

Month/Year	Event	Remarks
	<p>Under this Decree, the SSC was once again stipulated as a governmental agency to exercise the tasks and duties of the regulator and service-provider in the field of securities and securities markets. Accordingly, the SSCs duties and powers were made more appropriate with the requirement and development of the market in a new context. The SSCs duties and powers were as follows:</p> <p>2.2.1. Submitting to the Government, the Prime Minister or the Minister authorized by the Prime Minister the legal documents of securities and securities market for approval and then organizing the implementation of those documents;</p> <p>2.2.2. Submitting to the Government, the Prime Minister the strategy, orientation, programs, long-term, 5-year and annual plans, and other important projects of the SSC, and organizing the implementation of those after approval;</p> <p>2.2.3. Issuing, giving guidelines to, examining and organizing the application of standards, processes, procedures, and economic and technical requirements applicable to units and organizations within the SSC as stipulated by applicable laws of securities and securities market;</p> <p>2.2.4. Granting, extending, suspending or revoking licenses of securities issuance, securities listing or securities business and services, or licenses of securities business practitioners as stipulated by applicable laws;</p> <p>2.2.5. Submitting to the Prime Minister for decision to establish, suspend the operation of, or disperse the STC, the Stock Exchange, and other organized securities market;</p> <p>2.2.6. Organizing and managing the STC, the Stock Exchange and other organized securities market, and the centers for securities depository, registration, clearing and settlement;</p> <p>2.2.7. Regulating all operations related to the securities market by securities issuers, listing organizations, securities business organizations and other ancillary institutions as stipulated by applicable laws;</p> <p>2.2.8. Inspecting, examining and supervising all market participants and imposing sanctions to violations of securities and securities market laws as stipulated by applicable laws;</p> <p>2.2.9. Managing all investment and construction projects under its authority as stipulated by applicable laws; participating in the process of evaluating important projects in the field of securities and securities market as requested by the Government or Prime Minister;</p> <p>2.2.10. Giving guidelines to and creating favorable conditions for securities associations in pursuing their goals, missions and charters; examining the enforcement of regulations by these associations; imposing sanctions or proposing to other authorized governmental agencies the sanctions to violations committed by these securities associations as stipulated by applicable laws;</p> <p>2.2.11. Conducting scientific research in the field of securities and securities market; providing specialized training to officials and public servants of the SSC and its units, to securities practitioners and other market participants;</p> <p>2.2.12. Providing information, propaganda, and training in the field of securities and securities market to organizations and the public;</p> <p>2.2.13. Conducting international cooperation in the field of securities and securities market as stipulated by applicable laws;</p> <p>2.2.14. Giving decisions and guidelines for the implementation of the administrative reform program of the SSC, with the goals and contents approved by the Prime Minister;</p> <p>2.2.15. Managing its organizational apparatus and personnel; implementing the salary policies as well as other policies of valence, rewards and punishment for its officials and public servants within its scope of authority;</p> <p>2.2.16. Managing its assigned financial resources and assets and organizing the implementation of fiscal appropriations as stipulated by applicable laws;</p> <p>2.2.17. Observing the reporting regime to the Government, the Prime Minister, and other authorized agencies as stipulated by applicable laws.</p> <p>Concerning the organizational structure of the SSC as stipulated by the Decree No. 90, there were some adjustments in compliance with its revised functions, duties and powers and in line with the Governments general regulations applied to governmental agencies. Therefore, the SSCs organizational apparatus would consist of:</p> <p>a. The SSC's departments assisting its Chairman in exercising regulatory powers in securities and securities markets, including:</p> <ul style="list-style-type: none"> - The Securities Market Development Department: assisting the Chairman in designing strategies and policies for development of securities markets; - The Securities Issuance Management Department: assisting the Chairman in the management of securities issuance and listing; 	

continued on next page

Table 9.1 continuation

Month/Year	Event	Remarks
	<p>- The Securities Business Management Department: assisting the Chairman in the management of the organization and operation of securities business and service organizations;</p> <p>- The Legal Affairs Department: assisting the Chairman in exercising the regulatory powers through securities and securities market laws;</p> <p>- The Inspection and Supervision Department: assisting the Chairman and exercising its powers in inspection and supervision of the enforcement of securities and securities market laws;</p> <p>- The Planning - Finance Department: assisting the Chairman in the management of financial resources, accounting and construction work by the SSC's units;</p> <p>- The International Cooperation Department: assisting the Chairman in the issues of international cooperation and international integration in the field of securities and securities market;</p> <p>- The Human Resources Department: assisting the Chairman in the implementation of policies of organizational apparatus, personnel and training for officials and public servants of the SSC;</p> <p>- The Office of the SSC: assisting the Chairman in coordinating operations of the SSC and carrying out the administrative and logistic work of the SSC. The Office of the SSC has its representative branch in Ho Chi Minh City.</p> <p>b. The SSC's profit-seeking and service-providing organizations, include:</p> <p>- The Hanoi Securities Trading Center (HASTC) and the Ho Chi Minh City Securities Trading Center (HOSTC): being profit-seeking and service-providing units, having their own legal status, with the functions and duties of organizing, regulating, managing and supervising securities trading on these Centers. The HASTC is located at No. 5-7, Trang Tien Street, Hoan Kiem District, Hanoi; The HOSTC is located at No. 45-47, Chuong Duong Road, District I, Ho Chi Minh City and was inaugurated on 20 July 2000.</p> <p>- The Center for Information Technology and Statistics: being a profit-seeking and service-providing unit, having its own legal status, with the duties of assisting the SSC to exercise its regulatory powers in the field of information technology application in the securities industry, and providing public services to organizations and individuals operating in the field of securities and securities market. The Center for Information Technology and Statistics is located at No. 164, Tran Quang Khai Street, Hoan Kiem District, Hanoi and has a branch in Ho Chi Minh City.</p> <p>- The Securities Science Research and Training Center: being a profit-seeking and service-providing unit, having its own legal status, with the duties of assisting the SSC to exercise its regulatory powers in conducting the scientific research and training in the field of securities and securities market. The Securities Science Research and Training Center is located at No. 2, Phan Chu Trinh Street, Hoan Kiem District, Hanoi (temporarily) and has its branch in Ho Chi Minh City.</p> <p>- The Vietnam Securities Review: being a profit-seeking and service-providing unit, having its own legal status, with the duties of assisting the SSC to exercise its regulatory powers in communication and propaganda in the field of securities and securities market.</p> <p>The Vietnam Securities Review is located at No. 164, Tran Quang Khai Street, Hoan Kiem District, Hanoi and has its Representative Office in Ho Chi Minh City.</p> <p>c. The SSC's leadership includes:</p> <p>- Its Chairman and Vice-Chairmen, who are appointed by the Prime Minister;</p> <p>- Ex-officio commissioners, who are the Vice-Ministers of Planning and Investment, Finance, Justice, and SBV; these commissioners are assigned by the Prime Minister.</p> <p>In this period, the posts of Chairman and Vice-Chairmen did not change, except in January 2004, Mr. Nguyen Doan Hung, a Director from the SBV, was appointed by the Prime Minister to be Vice-Chairman of the SSC. As for the commissioners, Mr. Nguyen The Lien, Vice-Minister of Justice, replaced Mr. Ha Hung Cuong, who moved to another job; and Mr. Phung Khac Ke, Deputy Governor of the SBV, replaced Mrs. Duong Thu Huong, who became Vice-Chairperson of the Economic and Budget Committee of the National Assembly-Parliament).</p> <p>Regarding human resources, the SSC by then boasted of a 337-strong staff, of which 14 had Doctor's Degrees, 54 Master's Degrees, 202 Bachelor's Degrees, and 47 were doing their post-graduate courses both domestically and abroad. It is this personnel which played the vital role in implementing the SSC's assignments, helping ensure the safety and efficiency of the securities market over the past 4 years.</p>	
28 November 2003	"Decree on Securities and Securities Market," which limited the country's securities market regulation to the two STCs, namely, the state-run securities exchanges.	Decree No. 144/2003/ND-CP

continued on next page

Table 9.1 continuation

Month/Year	Event	Remarks
19 February 2004	<p>The transfer of the SSC into the Ministry of Finance. “Decree on Joining the State Securities Commission into the Ministry of Finance”</p> <p>To make collaboration among ministries and industries more efficient in speeding up the development of the securities market, the Government promulgated a Decree, according to which the SSC would be moved into and under the management of the Ministry of Finance.</p> <p>The process of transfer was completed on 16 March 2004 with the participation of and witnessed by leaders of the Ministry of Finance, the SSC, and relevant ministries.</p>	Decree No. 66/2004/ND-CP
17 June 2004	Decision by the Minister of Finance On the promulgation of Regulation on the organization and operation of securities companies	Decision No.55/2004/QD-BTC
17 June 2004	Circular Providing Guidance on Information Disclosure on the Securities Market	57/2004/TT-BTC
17 June 2004	Circular Providing Guidance on Securities Membership and Trading	58/2004/TT-BTC
8 June 2004	Circular Providing Guidance on the Listing of Stocks and Bonds on the Centralized Securities Markets	59/2004/TT-BTC
8 June 2004	Circular Guiding the Issuance of Stocks to the Public	60/2004/TT-BTC
3 September 2004	Decision of the Minister of Finance On the promulgation of the Regulation on the organization and operation of securities investment funds and fund management companies	Decision No.73/2004/QD-BTC
7 September 2004	Government’s Decree on penalties of administrative violations in the field of securities and securities markets	Decree No.161/2004/ND-CP
7 September 2004	<p>The Prime Minister’s Decision on the Functions, Duties, Powers and Organizational Structure of the State Securities Commission</p> <p>The reorganization of the SSC as an organization under the Ministry of Finance.</p> <p>Under the regulation of the above Decree and the Prime Minister’s Decision No. 161/2004/QD-TTg dated 7 September 2004, the SSC’s functions and duties had to undergo some adjustments and revisions.</p> <p>As a result, the SSC would be an organization under the Ministry of Finance, exercising the assigned tasks and duties of the regulator and service-provider in the field of securities and securities markets. Following is the SSCs organizational chart in accordance with the Decision No. 161/2004/QD-TTg by the Prime Minister.</p> <p>The revised tasks and duties of the SSC are as follows:</p> <p>2.3.1 Designing and submitting to the Minister of Finance legal documents of securities and securities market, the strategies, matrixes, long-term, 5-year, and annual plans on securities and securities market;</p> <p>2.3.2 Proposing the Minister of Finance to set up, suspend the operation of, or disperse the STCs, the Stock Exchange, the Securities Central Depository, and other organizations related to securities activities and securities trading in his authorization, or proposing the Minister of Finance to consider and submit to the Prime Minister the plans to set up, suspend the operation of, or disperse the above-mentioned entities;</p> <p>2.3.3 Implementing the legal documents, strategies, matrixes, and plans on securities and securities market after their ratification;</p> <p>2.3.4 Setting specialized standards, procedures and processes, and economic and technical specifications to be applied in organizations and units under its management, as stipulated by applicable laws and decided by the Minister of Finance;</p> <p>2.3.5 Issuing, extending, suspending or revoking certificates of registration of securities issuance, registration of securities trading, certificates of securities listing, certificates of securities business, and certificates of securities practices and services, as stipulated by applicable laws;</p> <p>2.3.6 Organizing and managing the STCs, the Stock Exchange, other regulated securities markets, and the Center for Securities Depository, Registration, Clearing and Settlement;</p> <p>2.3.7 Supervising the compliance to regulations of securities and securities market by organizations offering their securities to the public, organizations having their securities listed, securities business organizations, and other ancillary organizations, as stipulated by applicable laws;</p> <p>2.3.8 Implementing the inspection, examination and supervision of organizations and individuals participating in the securities market, and applying sanctions for violations of regulations of securities and securities market, as stipulated by applicable laws;</p>	PM’s Decision No.161/2004/QD-TTg

continued on next page

Table 9.1 continuation

Month/Year	Event	Remarks
	<p>2.3.9 Giving guidelines and creating favorable conditions for securities associations to abide by their objectives, missions and charters; supervising the compliance of regulations of securities and securities market of these associations; applying sanctions or proposing authorized agencies to apply sanctions for violations of laws by these associations, as stipulated by applicable laws and assigned by the Minister of Finance;</p> <p>2.3.10 Complying with the reporting regime on securities and securities market, as stipulated by applicable laws and assigned by the Minister of Finance;</p> <p>2.3.11 Carrying out international cooperation programs in the fields of securities and securities market, as stipulated by applicable laws and assigned by the Minister of Finance;</p> <p>2.3.12 Implementing the SSC's administrative reforms in accordance with the objectives and contents as approved by the Minister of Finance;</p> <p>2.3.13 Carrying out forecasting and analytical work, communication, propaganda, dissemination, and training in the fields of securities and securities market for institutions and individuals participating in the securities market;</p> <p>2.3.14 Organizing scientific research works on securities and securities market;</p> <p>2.3.15 Introducing, managing and applying information technologies; modernizing the management of securities and securities market as stipulated by applicable laws and assigned by the Minister of Finance;</p> <p>2.3.16 Managing the organizational apparatus and human resources; organizing training and retraining programs; and applying appropriate policies for the SSCs human resources as stipulated by applicable laws and assigned by the Minister of Finance;</p> <p>2.3.17 Managing its budget and assets as stipulated by applicable laws and assigned by the Minister of Finance;</p> <p>2.3.18 Accomplishing other duties assigned by the Minister of Finance.</p> <p>Regarding the organizational structure, there was change in the status of all of SSC's departments and divisions; and the Division of Information Technology was changed into the Center for Information Technology and Statistics. Subsequently, the Minister of Finance signed his Decision No. 3595/QD-BTC of 4 November 2004 on the duties, powers and organizational structure of the SSC's departments. Up to this moment, the SSC's leadership would not include the ex-officio commissioners as mentioned above, and Mr. Tran Xuan Ha became Acting Chairman of the SSC to replace Dr. Nguyen Duc Quang, who ceased his post pending retirement.</p> <p>The transfer of the SSC into the Ministry of Finance appeared to be an appropriate step in the process of developing the securities markets in Viet Nam. With the role and functions of a macro-financial policymaker and the regulator of the financial markets, the Ministry of Finance would be more responsive and efficient in working out and issuing regulatory policies.</p> <p>Consequently, a large amount of quality products and instruments would be supplied to the securities markets, which proved to be the key issue of the development of the securities markets in Viet Nam at present. At the same time, other financial policies initiated by the Ministry of Finance (such as those of bond issuance, fees and charges, etc.) would help strengthen the uniformity and consistency of and ensure the safety for the development of the securities and other financial markets.</p> <p>Besides, the change in the status of the SSC in particular and other governmental agencies in general is well in line with the Government's Masterplan of administrative reforms for the period of 2001–2010, with the goal of reforming the administrative apparatus and the content of "readjusting the functions and duties of the Government, ministries and ministerial-level agencies, governmental agencies and local governments of all levels in consistence with the role of the State in the new situation."</p> <p>3. Duties, Powers and Organizational Structure of the Departments, Inspection Department and Office of the SSC</p> <p>As mentioned above, the Minister of Finance signed Decision No. 3595/QD-BTC of 4 November 2004 on the duties, powers and organizational structure of the specialized departments, Office and Inspection Department of the SSC, wherein it is generally stipulated that these units are in the apparatus to assist SSC's Chairman in implementing all the duties and powers as specified in the Prime Ministers Decision No. 161, as well as other duties and powers assigned by the Minister of Finance. Specifically, the duties and powers of each unit are as follows:</p>	

continued on next page

Table 9.1 continuation

Month/Year	Event	Remarks
	<p>3.1 The Securities Market Development Department:</p> <p>3.1.1 Working by itself or collaborating with relevant departments to draft and then organize the implementation of legal documents and their guidance on securities trading on organized securities markets;</p> <p>3.1.2 Working by itself or collaborating with relevant departments to organize the implementation of strategies, masterplans, long-term, 5-year and annual plans of development of securities markets, and projects of organization and operation of organized securities markets;</p> <p>3.1.3 Taking part in drafting policies and regimes of taxes, fees, charges, and foreign exchange, and other policies and solutions for securities markets, as assigned by the SSCs Chairman;</p> <p>3.1.4 Collaborating with other departments of the SSC to organize the implementation, supervision and examination of the enforcement of legal regulations on the organization and management of securities trading on the STCs and the Stock Exchanges;</p> <p>3.1.5 Proposing solutions for the development of securities markets, ensuring the publicity, equitability and legality of the market operations;</p> <p>3.1.6 Collaborating with other departments of the SSC to set up the securities market information system for mapping out polices of securities market development and management; preparing periodical and irregular reports on the operations of the securities markets at the disposal of the SSC Chairman and request of the Minister of Finance;</p> <p>3.1.7 Making the SSC's annual reports;</p> <p>3.1.8 Accomplishing other duties assigned by the SSC Chairman.</p> <p>3.2 The Securities Issuance Management Department:</p> <p>3.2.1 Working by itself or collaborating with relevant departments to draft and then organize the implementation of legal documents and their guidance on issuance and listing of stocks and bonds;</p> <p>3.2.2 Working by itself or collaborating with relevant departments to organize the implementation of strategies, long-term and annual plans of development of securities for the markets;</p> <p>3.2.3 Building up and providing guidance for the implementation of specialized standards, procedures, and processes related to issuance and listing of stocks and bonds;</p> <p>3.2.4 Working by itself or collaborating with relevant departments of the SSC to organize the supervision and examination of the compliance of legal documents on the public issuance of stocks and bonds by issuing organizations, and the listing of stocks and bonds by listed organizations;</p> <p>3.2.5 Collaborating with relevant departments of the SSC to examine and supervise organizations having their stocks and bonds issued and listed in their maintenance of listing requirements, their disclosure of information and corporate governance;</p> <p>3.2.6 Receiving and verifying application statements for issuing stocks and bonds, and applications for listing of stocks and bonds; submitting documents to the SSC Chairman for granting, suspension, or revocation of certificates of issuance registration of organizations applying for securities issuance; submitting documents to the SSC Chairman for granting or revocation of listing licenses of organizations having their stocks and bonds listed; keeping track, gathering information, and providing analysis of the operations of issuing and listed organizations;</p> <p>3.2.7 Receiving and verifying applications of auditing organizations having satisfied all requirements for auditing securities issuing, listed and business organizations; submitting these documents to the SSC Chairman for approval;</p> <p>3.2.8 Collaborating with other departments of the SSC and relevant departments and organizations of the Ministry of Finance to work out policies and solutions for development and encouragement of organizations having their securities issued to the public and listed on the STCs or the Stock Exchange;</p> <p>3.2.9 Accomplishing other duties assigned by the SSC Chairman.</p> <p>3.3 The Securities Business Management Department:</p> <p>3.3.1 Working by itself to draft and then organize the implementation of legal documents and their guidance on the organization and operation of securities business and service-providing organizations;</p> <p>3.3.2 Working by itself to organize the implementation of policies, strategies, long-term and annual plans and projects on the organization and operation of securities business and service-providing organizations;</p> <p>3.3.3 Working by itself or collaborating with relevant departments of the SSC to organize the supervision and examination of the compliance of legal documents and other regulations on securities business and service providing; the public issuance of stocks and bonds by issuing organizations and the listing of stocks and bonds by listed organizations; keeping track, gathering information and providing analysis of the operations of securities business and service-providing organizations;</p>	

continued on next page

Table 9.1 continuation

Month/Year	Event	Remarks
	<p>3.3.4 Verifying application statements and submitting those documents to the SSC Chairman for granting or revocation of licenses of operation of securities business and service-providing organizations, licenses of establishment of investment funds and licenses of issuance of fund certificates, certificates of securities business practice of securities business and service-providing organizations and their practitioners;</p> <p>3.3.5 Verifying application statements and submitting those documents to the SSC Chairman for granting or revocation of licenses of establishment of representative offices of foreign securities business and service-providing organizations in Viet Nam; supervising the operations of these representative offices in compliance with applicable laws and regulations;</p> <p>3.3.6 Collaborating with other relevant departments of the SSC to organize examinations for re-granting of certificates of securities business practice;</p> <p>3.3.7 Collaborating with other relevant departments of the SSC to select auditing companies to provide auditing services to securities business and service-providing organizations;</p> <p>3.3.8 Providing consultancy to the SSC Chairman in giving guidance and assistance to securities associations in achieving their goals and mottos, and complying with their Charters; supervising the compliance of legal regulations by these associations;</p> <p>3.3.9 Collaborating with domestic and foreign organizations in promoting the development of securities business and service-providing organizations in accordance with directives by the Ministry of Finance and decisions by the SSC Chairman;</p> <p>3.3.10 Accomplishing other duties assigned by the SSC Chairman.</p> <p>3.4 The International Cooperation Department:</p> <p>3.4.1. Working by itself to build up and then organize the implementation of the SSCs strategies, long-term and annual plans, and projects of international cooperation;</p> <p>3.4.2. Collaborating with other departments of the SSC and organizations of the Ministry of Finance to participate in the latter's international cooperation programs in the field of securities and securities markets as assigned by the SSC Chairman and the Minister of Finances directives;</p> <p>3.4.3. Collaborating with other departments of the SSC to build up the regulation on the SSC's international operations, providing guidance and examining the implementation of this regulation as stipulated by the Minister of Finance;</p> <p>3.4.4. Collaborating with international organizations, foreign securities regulators, and other departments of the SSC to implement programs and technical assistance projects as assigned and authorized by the Minister of Finance; making synthesis and reports on the implementation of these programs and projects;</p> <p>3.4.5. Preparing the contents and completing procedures for the SSC to directly partake or collaborate with other organizations of the Ministry of Finance to discuss and sign agreements, or memoranda of understanding, of cooperation with foreign partners in the field of securities and securities markets; to discuss and sign documents of accession to international organizations of securities and securities markets as stipulated by the Minister of Finance;</p> <p>3.4.6. Collaborating with other departments of the SSC to prepare the contents, programs, plans, budget and international procedures for the SSCs delegations to take part in international workshops, conferences and study tours, and the programs for international delegations to pay working visits to the SSC;</p> <p>3.4.7. Collaborating with other departments of the SSC to organize and manage international workshops and conferences in accordance with approved plans; making reports of their results in accordance with the Minister of Finances directives;</p> <p>3.4.8. Conducting the interpretation work as specified in the SSCs regulation on international operations; carrying out the study and synthesis of news of worlds securities markets and regulation of the securities industry at the service of the SSC's leadership in accordance with the Minister of Finances directives;</p> <p>3.4.9. Accomplishing other duties assigned by the SSC Chairman.</p> <p>3.5 The Human Resources Management Department:</p> <p>3.5.1 Working out the strategy of the organizational structure and development of the human resources in the securities industry;</p> <p>3.5.2 Studying and proposing functions, duties, powers and organizational structure of the SSC and its departments;</p> <p>3.5.3 Managing and distributing the assigned amount of the SSCs salaried staff; conducting the work of recruitment, appointment, an increase of the staffs levels and their salary as authorized by the Minister of Finance;</p> <p>3.5.4 Exercising the work of staff planning, rotation, appointment, re-appointment, dismissal, punishment, transfer, retirement, resignation, and implementing other policies and regimes towards officers, employees and contractees under the management of the SSC as authorized by the Minister of Finance;</p>	

continued on next page

Table 9.1 continuation

Month/Year	Event	Remarks
	<p>3.5.5 Managing the personal files of officers and employees of the SSC as authorized by the Minister of Finance, providing guidance to other organizations of the SSC to keep the personal files and archives of their employees and contractees as stipulated by applicable laws;</p> <p>3.5.6 Working out programs, plans and projects of staff training for the SSC's officers, and collaborating with other relevant departments to implement those programs, plans and projects; managing, keeping track of and urging the compliance of regulations on sending the SSC's staff to domestic and foreign study courses with domestic or foreign financial sources;</p> <p>3.5.7 Implementing the work of internal political security as assigned by the Minister of Finance;</p> <p>3.5.8 Working by itself or collaborating with relevant parties to handle proposals, appellations, or denunciations related to human resources management as stipulated by applicable laws;</p> <p>3.5.9 Accomplishing other duties assigned by the SSC Chairman.</p> <p>3.6 The Planning - Finance Department: Exercising the Government's regulations and the Minister of Finance's authorization on financial management, expenditure management, budget for capital construction, and the assets of all the SSC's organizations:</p> <p>3.6.1 Working out annual budget and plans of utilizing the centralized financial sources of the SSC and its departments;</p> <p>3.6.2 Submitting to the SSC Chairman the plans of expenditure allocation and the budget for capital construction for the SSC's departments in accordance with its approved budget and projects;</p> <p>3.6.3 Making reports on the budget revenues and expenditures as stipulated by applicable laws and regulations; reporting to the SSC Chairman and submitting to the Ministry of Finance for approval, and making public all annual reports on revenues and expenditures of all the SSC's departments;</p> <p>3.6.4 Providing guidance and examination on the compliance of the financial and accounting regimes and other Government and Ministry of Finance regulations on purchase, management and utilization of public assets in the SSC's departments;</p> <p>3.6.5 Participating in the drafting, amendment and revision of legal documents on finance and accounting applied in the field of securities and securities markets;</p> <p>3.6.6 Managing the financial sources for capital construction in accordance with applicable laws and regulations and the Ministry of Finance's guidance;</p> <p>3.6.7 Collaborating with other departments and organizations to organize retraining courses for the SSC's staff working in the field of finance, accounting, and capital construction investment;</p> <p>3.6.8 Accomplishing other duties assigned by the SSC Chairman.</p> <p>3.7 The Legal Affairs Department:</p> <p>3.7.1 Working by itself or collaborating with other departments to draft legal documents in the field of securities and securities markets; requesting central agencies and local governments to contribute their opinions towards legal documents on securities and securities markets drafted by the SSC;</p> <p>3.7.2 Working out the SSC's annual and long-term programs and plans of drafting legal documents on securities and securities markets, and organizing the implementation of those programs and plans;</p> <p>3.7.3 Contributing its opinions and verification of the legality of legal documents and their guidance drafted by the SSC's departments prior to submission of these documents to the Ministry of Finance;</p> <p>3.7.4 Collaborating with other departments of the SSC to prepare files of draft legal documents on securities and securities markets for the SSC Chairman to request the Ministry of Finance's departments and organizations for verification and submission to the Minister of Finance;</p> <p>3.7.5 Providing consultancy to the SSC Chairman in contributing his opinions to legal documents drafted by the Ministry of Finance's departments and organizations and other central agencies;</p> <p>3.7.6 Collaborating with other departments of the SSC to provide proposals to the SSC Chairman in order to submit those to the Minister of Finance so that the latter shall suggest other to competent authorities to suspend the implementation of, or to amend or revise the legal documents promulgated by these competent authorities which have provisions contradictory, overlapping or inconsistent with the legal documents on securities and securities markets;</p> <p>3.7.7 Going through and systematizing all legal documents on securities and securities markets, and proposing solutions to the discovered problems; collaborating with other departments to publish legal documents on securities and securities markets;</p>	

continued on next page

Table 9.1 continuation

Month/Year	Event	Remarks
	<p>3.7.8 Collaborating with other departments and organizations of the SSC and those of the Ministry of Finance to organize the publication, dissemination and education of legal documents on securities and securities markets; supervising, examining and urging the compliance of legal documents on securities and securities markets; participating in proposing settlement of violations in regulations on securities and securities markets;</p> <p>3.7.9 Providing guidance and response to organizations' and individuals' inquiries related to securities and securities markets upon request and at the disposal of the SSC Chairman;</p> <p>3.7.10 Accomplishing other duties assigned by the SSCs Chairman.</p> <p>3.8 The Office of the SSC:</p> <p>3.8.1 Working out the SSC's periodical programs and plans of actions; making announcement and keeping track of these programs and plans, urging other departments and assisting the SSC Chairman coordinate the operations of the SSC's departments in implementing those programs and plans after their approval;</p> <p>3.8.2 Preparing programs, contents, and materials for interim and final meetings and conferences presided over by the SSC's leadership, and making public the results of those meetings and conferences; collaborating with other departments of the SSC to organize conferences and workshops;</p> <p>3.8.3 Working by itself or collaborating with other departments of the SSC to set up the SSC's Working Regulation, urging and supervising the compliance of this Regulation;</p> <p>3.8.4 Conducting the work of propaganda and dissemination of the SSC's official information to the mass media; collaborating with other departments of the SSC to publish annual reports and legal documents and their guidance on securities and securities markets;</p> <p>3.8.5 Organizing, managing, and providing guidance on the administrative, archive, health care and library work of the SSC;</p> <p>3.8.6 Managing the infrastructure and ensuring all the means and working conditions of the SSC; conducting self-protection and security work for the office of the SSC;</p> <p>3.8.7 Exercising the duties of the third-level budget-receiving organization in compliance with the regulations on States budget management;</p> <p>3.8.8 Acting as the owner of infrastructure and technical construction projects of the SSC in accordance with the Minister of Finances directives and the SSC Chairman's decisions;</p> <p>3.8.9 Acting as the standing member of the SSC Council for Emulation and Rewards;</p> <p>3.8.10 Accomplishing other duties assigned by the SSCs Chairman.</p> <p>3.9 The Inspection Department:</p> <p>3.9.1 Exercising the duties and powers of the Securities Inspection as stipulated by applicable laws and regulations, and as authorized by the Minister of Finance and the SSCs Chairman;</p> <p>3.9.2 Accomplishing other duties assigned by the SSCs Chairman.</p> <p>4. Duties and Powers of the SSC's Profit-Making and Service-Providing Units</p> <p>4.1 The Hanoi Securities Trading Center:</p> <p>The Hanoi Securities Trading Center (HASTC) has its duties and powers in compliance with Article 61, 62 and 63 of the Governments Decree No. 144/2003/ND-CP dated 28 November 2003 on securities and securities markets and the SSC Chairman's Decision No. 329/QD-UBCK the dated 17 December 2003 as follows:</p> <p>4.1.1 Organizing, managing and supervising the operations on the HASTC;</p> <p>4.1.2 Managing and operating the trading system of the HASTC;</p> <p>4.1.3 Managing and supervising the listing of securities;</p> <p>4.1.4 Managing and supervising the operations of the HASTC's members and other ancillary organizations as stipulated by applicable laws and regulations;</p> <p>4.1.5 Organizing, managing and conducting the disclosure of market information; providing information services as stipulated by applicable laws and regulations;</p> <p>4.1.6 Providing securities registration, depository, clearing and settlement services as stipulated by the SSC Chairman's directives until an independent Securities Depository Center is established;</p> <p>4.1.7 Promulgating, providing guidance to, examining and organizing the implementation of specialized procedures and processes applied on the HASTC;</p>	

continued on next page

Table 9.1 continuation

Month/Year	Event	Remarks
	<p>4.1.8 Discovering and proposing forms of handling violations of regulations on securities and securities markets as stipulated by applicable laws and regulations;</p> <p>4.1.9 Collaborating with other specialized departments of the SSC to submit to the SSC Chairman's suggestions and solutions to stabilize and develop market activities;</p> <p>4.1.10 Collecting fees as stipulated by applicable laws and regulations;</p> <p>4.1.11 Establishing and managing the Compensation Supporting Fund as stipulated by applicable laws and regulations;</p> <p>4.1.12 Acting as an intermediary upon request to reconcile among parties in disputes related to listed securities;</p> <p>4.1.13 Exercising the reporting, statistical, accounting and auditing regimes, and managing the HASTC's assets as stipulated by applicable laws and regulations;</p> <p>4.1.14 Conducting international cooperation in the field of securities and securities markets as stipulated by the SSC Chairman's directives;</p> <p>4.1.15 Accomplishing other duties as assigned by the SSC's Chairman.</p> <p>4.2 The Ho Chi Minh City Securities Trading Center: The Ho Chi Minh City Securities Trading Center (HOSTC) has its duties and powers in compliance with Article 61, 62 and 63 of Decree No. 144/2003/ND-CP dated 28 November 2003 on securities and securities markets and the Decision No. 328/QD-UBCK by the SSCs Chairman dated 17 December 2003 as follows:</p> <p>4.2.1 Organizing, managing and supervising the operations of the HOSTC;</p> <p>4.2.2 Managing and operating the trading system of the HOSTC;</p> <p>4.2.3 Managing and supervising the listing of securities;</p> <p>4.2.4 Managing and supervising the operations of the HOSTC's members and other ancillary organizations as stipulated by applicable laws and regulations;</p> <p>4.2.5 Organizing, managing and conducting the disclosure of market information; providing information services as stipulated by applicable laws and regulations;</p> <p>4.2.6 Providing securities registration, depository, clearing and settlement services as stipulated by the SSC Chairman's directives until an independent Securities Depository Center is established;</p> <p>4.2.7 Promulgating, providing guidance to, examining and organizing the implementation of specialized procedures and processes applied on the HASTC;</p> <p>4.2.8 Discovering and proposing forms of handling violations of regulations on securities and securities markets as stipulated by applicable laws and regulations;</p> <p>4.2.9 Collaborating with other specialized departments of the SSC to submit to the SSC Chairman suggestions and solutions to stabilize and develop market activities;</p> <p>4.2.10 Collecting fees as stipulated by applicable laws and regulations;</p> <p>4.2.11 Establishing and managing the Compensation Supporting Fund as stipulated by applicable laws and regulations;</p> <p>4.2.12 Acting as an intermediary upon request to reconcile among parties in disputes related to listed securities;</p> <p>4.2.13 Exercising the reporting, statistical, accounting and auditing regimes, and managing the HOSTC's assets as stipulated by applicable laws and regulations;</p> <p>4.2.14 Conducting the international cooperation in the field of securities and securities markets as stipulated by the SSC Chairman's directives;</p> <p>4.2.15 Accomplishing other duties as assigned by the SSC Chairman.</p> <p>4.3 The Securities Science Research and Training Center: The Securities Science Research and Training Center (SSRTC) has its duties and powers in compliance with the Decision No. 330/QD-UBCK by the SSC Chairman dated 17 December 2003 as follows:</p> <p>4.3.1 Managing the SSC's scientific research works in the field of securities and securities markets;</p> <p>4.3.2 Working out the SSC's long-term and annual programs and plans of scientific research, submitting these to the SSC Chairman and organizing the implementation of these after their ratification;</p> <p>4.3.3 Organizing scientific workshops and providing information and scientific data on securities and securities markets; collaborating with departments of the SSC and other research institutions to implement and apply scientific research results and achievements in operations in the securities industry;</p> <p>4.3.4 Providing the SSCs staff with specialized training courses, training courses conducive to granting securities managers and practitioners with certificates of securities practice, in accordance with the approved training programs conducive to granting of certificates of securities practice, and training course for other market participants;</p>	

continued on next page

Table 9.1 continuation

Month/Year	Event	Remarks
	<p>4.3.5 Collaborating with other relevant departments and units of the SSC to provide information and disseminate knowledge of securities and securities markets to other organizations and the public;</p> <p>4.3.6 Compiling, translating and publishing materials, textbooks and other publications for research, study and training in the field of securities and securities markets;</p> <p>4.3.7 Cooperating with domestic and foreign scientific and training institutions for research, study and update of knowledge of securities and securities markets in compliance with applicable laws and regulations and the SSCs Chairman's directives;</p> <p>4.3.8 Accomplishing other duties as assigned by the SSC's Chairman.</p> <p>4.4 The Center of Securities Information and Statistics: The Center of Securities Information and Statistics (CSIS) has its duties and powers in compliance with the Decision No. 22/QD-UBCK by the SSCs Chairman dated 3 February 2004 as follows:</p> <p>4.4.1 Drafting and submitting to the SSC Chairman the long-term and annual programs on the development of information technology in the field of securities and securities markets, and organizing the implementation of these programs after their approval;</p> <p>4.4.2 Drafting and submitting the SSC Chairman for promulgation of standards, procedures and economic-technical specifications applicable in the SSC's organizations and units, and providing guidance for the implementation of these standards, procedures and economic-technical specifications;</p> <p>4.4.3 Collaborating with relevant organizations to work out and implement programs and projects of application of information technology in operations in the field of securities and securities markets;</p> <p>4.4.4 Receiving and transferring technologies; managing and operating information technology systems given to the SSC by the Government's projects or by domestic or foreign organizations in accordance with the SSC Chairman's decisions;</p> <p>4.4.5 Building, operating, developing, maintaining and managing the SSC's information systems and information technology infrastructure; managing and operating the SSC's internal information network;</p> <p>4.4.6 Assisting the SSC's Steering Board of the Project of Computerization of Administrative Management in implementing this Project in the SSC;</p> <p>4.4.7 Building, managing and operating the SSC Database Center; gathering, retrieving, processing and exploiting data in the field of securities and securities markets; ensuring security and confidentiality of the SSC's information system and electronic database;</p> <p>4.4.8 Cooperating with other relevant departments and units of the SSC to organize scientific research and provide training courses of information technology to the SSC staff and other organizations and individuals taking part in the securities industry; organizing workshops and conferences of application of information technology in the securities industry;</p> <p>4.4.9 Cooperating with domestic and foreign organizations involved in the application of information technology in the field of securities and securities markets in compliance with applicable laws and regulations and the SSC Chairman's directives;</p> <p>4.4.10 Providing advisory and technical services in information technology in compliance with applicable laws and regulations;</p> <p>4.4.11 Accomplishing other duties as assigned by the SSC Chairman.</p> <p>4.5 The Securities Review: The Vietnam Securities Review has its duties and powers in compliance with the Decision No. 331/QD-UBCK by the SSC Chairman dated 17 December 2003 as follows:</p> <p>4.5.1 Working out the long-term and annual programs and plans of information dissemination and propaganda in the field of securities and securities markets, submitting these programs and plans to the SSC Chairman for ratification; and organizing the implementation of these;</p> <p>4.5.2 Editing, publishing and distributing the <i>Securities Review</i> in Vietnamese and foreign languages in compliance with the Press Law, the SSC Chairman's directives, and the License of Press Operations granted by the Ministry of Culture and Information;</p> <p>4.5.3 Collaborating with other departments and units of the SSC and other channels to provide information and propaganda of the policies mapped out by the Government, and other regulations and operations related to securities and securities markets;</p> <p>4.5.4 Providing synthesis and press briefing on the contents related to securities and securities markets so as to serve the leadership of the SSC in managing and regulating the securities markets;</p>	

continued on next page

Table 9.1 continuation

Month/Year	Event	Remarks
	<p>4.5.5 Organizing the implementation of information and propaganda activities in the following forms:</p> <ul style="list-style-type: none"> a. Building up the database for the work of information dissemination, research, and management of securities and securities markets; b. Printing publications and reports on securities and securities markets in compliance with applicable laws and regulations; c. Collaborating with other departments and units of the SSC to organize workshops and conferences of securities and securities markets; d. Collaborating with other departments and units of the SSC to provide specialized training and retraining in the field of press and journalism to the staff of the <i>Securities Review</i> and other interested participants; e. Cooperating and exchanging with other domestic and foreign organizations and agencies to conduct information dissemination and propaganda of securities and securities markets in compliance with applicable laws and regulations and the SSC Chairman's directives; f. Providing information and press services in compliance with applicable laws and regulations; <p>4.5.6 Accomplishing other duties as assigned by the SSC's Chairman.</p> <p>5. Performance of the Securities Market up to December 2004:</p> <p>After more than 4 years of operation, the securities market of Viet Nam has gradually stepped into the path of stability and growth. On 2 July 2000, when the HOSTC was officially inaugurated, it boasted of 24 listed companies with their total charter capital of D1,240 billion, 140 kinds of government bonds, 2 commercial bonds of the Bank for Investment and Development of Vietnam, and 1 municipal bond, with their total listed value of D17,300 billion. Until December 2004, the SSC has granted licenses of securities business operation to 13 securities houses, one fund management company, and five depository banks. In 2004, the first securities fund started its operations by mobilizing capital and went listed on the HOSTC. Up to June 2004, 820 trading sessions were successfully effected on the HOSTC, with the total trading value averagely reaching over D17 billion per session. On 30 June 2004, Viet Nam Index mounted to 249.7 points, with an increase of 80.5 basis points (or 47.6%) as compared to early 2004. The total market capitalization at this point accounted for 3.4% of gross domestic product, or more than double compared to 2003.</p> <p>On 28 November 2003, the government promulgated Decree No. 144/2003/ND-CP on securities and securities markets (hereinafter referred to as Decree No. 144) to replace Decree No. 48/1998/ND-CP. This legal document consisted of new regulations to create more favorable conditions for the listing of companies, the operation and management of the markets, and for better protection of legitimate rights and interests of investors. With a better-defined viewpoint of encouraging investment and capital mobilization, Decree No. 144 boasted of considerable steps forward by introducing more flexible standards and listing requirements, thus allowing enterprises to get easier access to the centralized securities markets for their capital mobilization. The scope of regulation of Decree No. 144 was more open in terms of public issuance of securities. This was a very significant change to enhance the institutional effectiveness and minimize risks exposed to investors. Moreover, Decree No. 144 also permitted diversification of types of securities funds so as to encourage more from individual and institutional investors to get involved in the securities industry.</p> <p>Though at an early stage of development, Viet Nam's securities market has gradually approached international standards in its path to growth and attracted an increasingly large number of investors, both domestic and foreign. Auditing and information disclosure are two compulsory requirements for all issuing and listed organizations. International practices in corporate governance have been applied to all market participants to enhance the quality of listed securities. Presently, all listed companies have to comply with the Model Charter issued in November 2002.</p> <p>Two (2) years after the operation of the market, having recognized the importance of foreign investors' participation in the securities market, Viet Nam's Prime Minister decided to extend the scope of foreign investors' ownership share of listed companies to 30% from just 20%, and not to limit their ownership of bonds. The government also allowed foreign securities business organizations to contribute their capital to joint ventures with local partners, with a maximum capital contribution of 49%. Other foreign exchange policies were adjusted to facilitate the transfer of earnings from securities investments abroad. Apart from that, both domestic and foreign individual investors were exempted from personal income tax when they invested in securities. Last, but not the least, the government invalidated the tax on repatriation of profits. With a view to providing a mid- and long-term vision for the securities market development, on 5 August 2003, the Prime Minister ratified and promulgated the Strategy for Development of the Securities Market up to 2010. The determination of a strategic plan of actions of each year for the SSC was of first-rank</p>	

continued on next page

Table 9.1 continuation

Month/Year	Event	Remarks
	<p>importance in building and developing the securities market in Viet Nam. On the basis of this strategy, the Minister of Finance held that the HOSTC should follow the model of a centralized securities market to be developed to a full-fledged stock exchange and linked to other markets in the region, while the Hanoi Securities Trading Center (HASTC) would be a market for trading of stocks of small- and medium-size enterprises, to become an OTC market. Parallel with preparation of material and technical facilities for the STCs, at the moment, there have been other pieces of work which need a lot of effort to complete, such as the development of financial intermediaries, expansion of investor base, and finalization of the draft law on securities and securities markets which contain a more comprehensive scope and a wider range of issues.</p> <p>The facts and figures presented above are evidence of a sustainable and encouraging growth of the securities market, though with a modest level, as this is quite a new and sophisticated financial institution for Vietnamese regulators and investors, in particular, and for Vietnamese economy in general; it is a transitional period on its right track to a market-oriented economy. However, this path is without its challenges, and paved also with a lot of limitations and hindrances on many aspects, such as lack of experience in regulation and supervision of the market, incomplete and non-uniform legal framework, lack of quality goods for the market, and so on. The following are some of these challenges in greater detail:</p> <p>Firstly, there are limitations in the legal framework and institutional capacity in policy making. As with the legal framework, the biggest hindrance so far has been that the securities market is operating not under the regulation of a full and complete securities law. In Viet Nam, the field of securities and securities markets is still regulated by other relevant legislations, such as the Enterprise Law, Law of Credit Organizations, Law of Insurance Business, Bankruptcy Law, and others. Worth considering is that the legal status of Decree No. 144 is lower than the said legislations and that the legal environment is by no means uniform; therefore, mismatches and conflicts among these legal documents and those of securities and securities markets are inevitable. It is well known that a stable and consistent legal environment is the first and foremost important factor for ensure investors' confidence. Domestic and foreign investors shall invest their money in the securities market only when they find that their investment money and expectation of profits are both protected by a transparent and equitable legal framework. Thus, the Securities Law would help ensure part of their confidence.</p> <p>Besides, the capacity of policy making and law enforcement should also be paid due attention. The SSC and other relevant authorities have not been strongly equipped to exercise their regulatory and supervisory powers, as well as to enforce the compliance of applicable legal documents and regulations on securities and securities markets. This is partly because the regulatory staff does not have sufficient experience and capabilities to work out and implement appropriate policies for the development of the market, and to attract and protect of investors and their interests.</p> <p>Secondly, there are limitations in terms of market mechanisms. Regarding the mobilization of investment capital, the limitations in terms of market mechanisms have imposed a lot of considerable hindrances not only to ensure the safety of capital flows, but also of market sovereignty and confidence of both domestic and foreign investors. As for a newly established market, the lack of uniform market mechanisms can be understood now as a matter of course. But the absence of self-regulatory organizations, credit rating agencies, an independent center for securities registration, depository, clearing and settlement, professional securities houses, and, above all that, the low legal status of the securities regulator are all the weaknesses which make investors think that investment in the securities markets means exposure to a lot of risks. Apart from that, these weaknesses shall pose many kinds of difficulties to investors in making their investment decisions and alleviating those risks.</p> <p>Thirdly, there are limitations in terms of supply of securities. After more than 4 years since its inauguration, Viet Nam's securities market has been faced with a very limited supply of securities, not to count the low quality of these products. A market with 24 listed stocks of enterprises of low capital size cannot reflect the whole picture of Viet Nam's economy for investors to judge its health as well as its prospects. Similarly, the total number of listed stocks is low that investors cannot have a wide choice for their investment to substitute traditional bank deposits. Presently, listed stocks are not of the biggest companies to convince domestic and foreign investors that their money could bring them profits from these stocks in the short term.</p>	

continued on next page

Table 9.1 continuation

Month/Year	Event	Remarks
	<p>Fourthly, there are limitations in investor base. Due to a number of economic and social factors, up to this moment, the securities market of Viet Nam does not have a firm and stable investor base compared with other developed markets. The majority of investors now on the market are small investors who lack both experience and knowledge on securities investment. This is caused by two factors: first, the securities market itself is still in its early stage, so it cannot be developed in days or weeks. Besides, there have not been strong and key institutions which function as market-makers. Secondly, the system of legal documents of the securities and securities markets is not yet full and complete, and the supply of securities to the market is still limited, which hinders investors from showing their interest and actually participating in this market.</p> <p>6. Further Steps Taken to Develop the Securities Markets</p> <p>Concerning the function and performance of the securities market, the government and the securities regulator are faced with a big question of how to make it an efficient channel of capital mobilization for investment and development. It is true that a securities market can exist and develop only when it becomes an efficient tool for attracting idle money and savings among the public, as well as increasing foreign capital inflows. With a view to achieve the strategic goal of developing a safe and efficient securities market for mobilization of domestic and foreign capital flows for economic and social development, and on the basis of subjective judgments mentioned above, the SSC sets the following duties:</p> <p>6.1. Perfecting the legal documents of securities and securities markets and enhancing the SSC's institutional capacity for policy making. A comprehensive and consistent legal environment is synonymous to a safe and efficient investment environment. Being well aware of this viewpoint, the SSC was actively engaged in the drafting of the Securities Law. As planned, the draft law was submitted to the National Assembly (Parliament) in 2006 and expected to be ratified and promulgated for implementation by 2007. Based on the assumption that a level playing field would be created for every stakeholder, this draft law helps enterprises get easier access to mid- and long-term capital sources, minimize their risks of mobilizing funds from other sources, and provide investors with a highest level of protection of their rights and interests.</p> <p>Parallel to this process of preparing the legal documents of highest status, the work of enhancing the securities regulator's institutional capacity in policy making has also been implemented. Knowledge and skills of analysis, and evaluation of and forecasting market situations have been key contents of training the regulatory and supervisory staff so that policies can be implemented effectively. Another top priority of the SSC is to plan its annual, mid- and long-term plans of actions, based on which specific steps are taken for each suitable period of market development. One of the criteria required for the process of perfecting the legal framework and enhancing the SSC's institutional capacity in its policy making is the introduction of international standards and practices compatible with Viet Nam's specific situations and conditions.</p> <p>6.2. Perfecting market mechanisms and enhancing market intermediaries' capacity</p> <p>As mentioned above, in order to ensure a stable investment environment and minimize market risks of all sorts, such pieces of work should be carried out as consolidating and modernizing existing market institutions, such as the STCs, securities houses, fund management companies, etc. In these institutions, both the financial capacity and operation capacity of securities houses must be intensified. As with the capacity of operation, specialized knowledge and skills of the securities houses' practitioners must meet the requirements of the fast changing and ever challenging investment environment.</p> <p>Furthermore, securities funds with their considerable capacity of capital and expertise for investment must be encouraged to take part in the market to make investment activities of all market participants more professional, and provide guidance and direction to small investors. Other ancillary institutions, such as credit rating agencies, and an independent center for securities registration, depository, clearing and settlement should be established and put into operation to provide reliable and efficient service to these market participants.</p> <p>As with self-regulatory organizations, such as the Securities Business Association and the Association of Financial Investors, their role in the securities industry must be brought into full play in order for these market participants to exercise their self-regulation, relieve the work burden of the securities regulator in regulating and supervising the market, and, most importantly, to enhance the regulatory efficiency and effectiveness through a check-and-balance mechanism.</p>	

continued on next page

Table 9.1 continuation

Month/Year	Event	Remarks
	<p>6.3. Increasing both quantity and quality of listed securities Increasing the supply of securities is an indispensable measure as far as policies of market development are concerned. It is earlier mentioned that majority of securities supplied to the market comes from equitized state-owned enterprises (SOEs). Therefore, the equitization process is so organic in the securities market development. At the moment, these enterprises are all in need of assistance and support for their restructuring, valuation, and the initial public offering of their stocks. The process of equitization of SOEs, thus, must be made easier and faster so that more quality products will be brought to the market for investors' diversification of their investments. In order to tackle part of the difficulties in the process of corporate valuation prior to equitization, the valuation of corporate assets must then be conducted by market intermediaries instead of the councils of corporate valuation of the enterprises themselves as previously done. Professionalism of a higher level and the independent status of the market intermediaries, such as auditing firms and securities houses, would help provide a more exact price level of stocks offered to the public, and reduce negative aspects in the equitization process. In accordance with the Government Decree No. 187/2004/ND-CP dated 16 November 2004, the offering of stocks of SOEs with a capital size of more than D10 billion would have to be auctioned via the STCs, helping existing and potential investors to get easier access to participate in these auctions and, thus, get more involved in the corporate transformation. The linkage between equitization and listing of stocks of the equitized SOEs would help push forward the equitization process which staggered recently. Another focal point worth considering is the equitization of state-owned big corporations and commercial banks and the transformation of foreign-invested joint ventures into joint-stock companies. These moves would surely enhance the quality of securities listed on the securities markets in the short term.</p> <p>6.4. Developing the base of both domestic and foreign individual and institutional investors Another solution in terms of market policies is the extension of the foreign investor base and consolidation of domestic investors' base. Apart from direct policies to encourage foreign investors, such as exemption of income tax and easing of foreign exchange policy, it is necessary to increase the opportunity of getting access to corporate information by foreign investors by encouraging companies to disclose and disseminate their financial information, issuance of their prospectuses, reports on their performance and compliance of regulations, and practice of corporate governance in English through the mass media or their websites, the SSC, or STCs. This is really significant in the sense that, on the one hand, it attracts more foreign investors' attention and interest and, on the other, enterprises would gradually establish a new culture of external and public relations.</p> <p>As for domestic investors, the most important thing is that they should upgrade their knowledge as well as their skills in securities investment. This can partly be done by propaganda, programs on the mass media, and through training courses tailored for the public.</p> <p>The establishment of securities investment funds and allowing these funds to engage in joint ventures are another positive move taken by the regulator towards specialization of investment activities and enhancement of securities investment skills.</p> <p>6.5. Developing the securities markets in their relationship with other sectors of the financial markets For the financial markets to develop in a comprehensive, well-balanced and efficient manner, closely and harmoniously linked to other sectors of these markets, the development of the securities markets must be well in line with that of the insurance and money markets. The insurance market is a major provider of institutional investors with most considerable financial potential for the securities markets and, consequently, the securities markets create more investment instruments for insurance companies to be able to manage and diversify their portfolio in the most efficient way. In this regard, the insurance market in Viet Nam now has attracted a large amount of clients, as well as their capital. By the end of 2003, revenues from insurance premiums of five life insurance companies reached over D7,000 billion, more than double the same period of the previous year. The question is how to encourage these insurance companies to take a more active role in investing in the securities markets. Legal documents of securities and securities markets now have allowed insurance companies to set up their affiliated fund management companies to manage funds obtained from insurance premiums and insurance reserves to be financially invested and these fund management companies can engage in the securities markets as institutional investors.</p>	

continued on next page

Table 9.1 continuation

Month/Year	Event	Remarks
	<p>As a provider of major sources of medium- and long-term capital for development investment, the securities market has been developed in parallel with the money market—the provider of short-term finance through its credits and loans. These two channels of fund raising are complementary, not substitutive, to meet short- and long-term capital needs of the economy. The simultaneous and efficient growth of both markets shall produce short- and long-term yield curves to reflect the capital needs in the short and longer terms of the economy, helping investors to form their investment strategies and manage their portfolio of assets more efficiently. The linkage between the money market and securities market is evidenced by the bond market, in which government bonds play the focal role. Repo, swaps and other open market operations are solutions for the enhancement of this linkage.</p> <p>Besides the solutions mentioned above for the development of markets and mobilization of domestic and foreign capital flows, the SSC has been well aware of the inevitability and importance of integration with regional financial markets. As a member of the Association of Southeast Asian Nations (ASEAN), Viet Nam's securities markets cannot stand aside from the on-going process of integration in the region. Recently, the SSC has been actively taking part in the implementation of 11 points of capital market development in this region as mapped out in the ASEAN's Ha Noi Action Plan. In the framework of this Plan, common shared efforts should be made in order to accomplish all the commitments and workload towards increasing cross-border relations in the securities and securities markets in the short term, on the one hand, and towards international integration of financial markets in the long term, on the other.</p>	
04 November 2004	The Finance Minister's Decision on the Duties, Powers and Organizational Structure of the Departments, Office and Inspection Department of the State Securities Commission	Decision No.3595/QD-BTC
2006	The draft Law on Securities and Securities Markets was submitted to the National Assembly.	No 70/2006/QH11
01 January 2007	The Securities Law, which regulates Securities and Securities Markets, was enacted. This new law expanded its purview to unlisted securities, clarify public offering procedures, and incorporate basic provisions for a central securities depository, investment funds, investment advisory, self-regulatory organizations and so on.	No 70/2006/QH11
02/August-2007	Prime minister's Decision on Approval of the Project for the Development of Vietnam's Capital Market up to 2010 and Outlook to 2020.	PM's Decision No. 128-2007-QD-TTg
January 15 2008	Finance Minister of Vietnam has approved the Project to build up the Specialized Government Bond market and authorized Hanoi Stock Exchange to run the Specialized Government bond market solely	Decision 86/QD-BTC dated 15 Jan 2008
July 1, 2008	Finance Minister of Vietnam has signed the Decision on the issuance of Trading Management stipulation of Government Bond at Hanoi Securities Trading Center (former of HNX)	Decision 46/2008/QD-BTC dated 1 July 2008
January 2011	Government has released a Decree stipulated on the issuance of Government Bonds, Government Guaranteed Bonds and Municipal Bonds via auction which are implemented exclusively on HNX; replacing Decree 141/2003/ND-CP	Decree 01/2011/ND-CP
February 2012	Finance Minister signed a Circular to provide guidelines for Government Bond Issuance in the domestic market which supports Decree 01/2011/ND-CP	Circular 17/2012/TT-BTC

Source: State Securities Commission.

X. Items for Future Improvement

In 2007, the International Finance Corporation (IFC), through the Mekong Project Development Facility (MPDF),²⁵ conducted a gap analysis titled “Vietnam Capital Market Diagnostic Review,” which concluded on a range of topics for future improvements of the Viet Nam market. The analysis covered more than just the bond market. The details can be accessed from IFC’s website.²⁶

While some of the original findings may still be valid for the broader capital market, the past four years have seen significant developments in a number of bond market-related subjects put forward in 2007. These include the introduction of a code of conduct for bond market participants, through the Vietnam Bond Market Association, and the creation of a central infrastructure to support over-the-counter bond trading.

Among the challenges in the market remain the need for capacity building and the shift of processes from often manual or non-electronic means towards an integrated market solution. The Vietnam Securities Depository serves as the spearhead of development in this regard. For more details on possible items for improvement, please also see Chapter IV on Possible Impediments and Restrictions.

²⁵ The Mekong Project Development Facility (MPDF) is a multi-donor program of ADB, Australia, Canada, the European Union, Finland, International Finance Corporation, Ireland, Japan, the Netherlands, New Zealand, Norway, Sweden, Switzerland, and the United Kingdom.

²⁶ International Finance Corporation. 2007. *Vietnam Capital Market Diagnostic Review*. [http://www.ifc.org/ifcext/mekongpsdf.nsf/AttachmentsByTitle/Capital-Market-Diagnostic/\\$FILE/Capital-Market-Diagnostic.pdf](http://www.ifc.org/ifcext/mekongpsdf.nsf/AttachmentsByTitle/Capital-Market-Diagnostic/$FILE/Capital-Market-Diagnostic.pdf)

XI. Next Steps ⇔ Future Direction

A. Future Direction: Viet Nam's Capital Market Outlook to 2020

Future direction of Viet Nam's capital market is enshrined in the *Decision on Approval of the Project for Development of Vietnam's Capital Market up to 2010 and Outlook to 2020*, which was passed in 2 August 2007. The full text of the decision can be found in Appendix 1.

B. Group of 30 Compliance²⁷

Table 11.1 Group of Thirty Compliance

	Recommendation	Implemented
1	Eliminate paper and automate communication, data capture, and enrichment	No
2	Harmonize messaging standards and communication protocols	No
3	Develop and implement reference data standards	No
4	Synchronize timing between different clearing and settlement systems and associated payment and foreign exchange systems	No
5	Automate and standardize institutional trade matching	Yes
6	Expand the use of central counterparties	No
7	Permit securities lending and borrowing to expedite settlement	No
8	Automate and standardize asset servicing processes, including corporate actions, tax relief arrangements, and restrictions on foreign ownership	Corporate actions standardization: Yes Tax: No Foreign ownership restrictions: Yes
9	Ensure the financial integrity of providers of clearing and settlement services	Yes
10	Reinforce the risk management practices of users of clearing and settlement service providers	Yes
11	Ensure final, Simultaneous transfer and availability of assets	Yes
12	Ensure effective business continuity and disaster recovery planning	No
13	Address the possibility of failure of a systematically important institution	No
14	Strengthen assessment of the enforceability of contracts	Yes
15	Advance legal certainty over rights to securities, cash, or collateral	Yes
16	Recognize and support improved valuation methodologies and closeout netting arrangements	Yes

²⁷ Group of 30 (G30). 2003. Global Clearing and Settlement – A Plan of Action. <http://www.partad.ru/world/word/g30app1.pdf>

Table 11.1 continuation

	Recommendation	Implemented
17	Ensure appointment of appropriately experienced and senior board members (of the boards of securities clearing and settlement infrastructure providers)	Yes
18	Promote fair access to securities clearing and settlement networks	Yes
19	Ensure equitable and effective attention to stakeholder interests	Yes
20	Encourage consistent regulation and oversight of securities clearing and settlement service providers	Yes

C. Group of Experts Final Report: Summary of Barriers and Market Assessment – Viet Nam (April/2010)

Table 11.2 Group of Experts Final Report on Viet Nam

Potential Barrier Area	Current Situation	Market Assessment Questionnaire Scores	Overall Barrier Assessment
Quotas	There are foreign ownership limits on equities but not on bonds, unless the issuer chooses to set a limit. The market is generally viewed as open to foreign investors.	LOW	OK
Investor registration	Foreign investors need to obtain a trading code. This is granted within 1–2 weeks of validly completed applications. The documentation requirements were previously onerous (requiring consularisation of documents) and requirements for certain types of entities were not clear. However, the requirements have been simplified under new regulations issued in December 2008.	LOW	LOW
Foreign exchange controls - conversion	Foreign investors are allowed to convert foreign currency to Vietnamese dong in order to trade on the Hanoi and Ho Chi Minh exchanges. The rate must be within a fixed margin of $\pm 5\%$ of the official exchange rate fixed by the State Bank of Vietnam on a daily basis (previously 3%). Foreign investors are only able to execute foreign exchange transactions for same-day, next day, or spot value. Foreign currency forwards cannot be sold to foreign investors. Third-party foreign exchange is possible, but uncommon. There are no clearly defined procedures or documentation requirements, and as a single payment system does not exist, third-party foreign exchange may be problematic.	LOW	LOW
Foreign exchange controls - repatriation of funds	Sales proceeds, dividends and interest may be freely repatriated, subject to tax certification. However, the foreign exchange market can be highly illiquid. This is of major concern to investors. “Because VND [Vietnamese dong] constantly trades at upper end of trading band, FX [sic] requests are placed in a queue that may take ages to be considered.” “The way that capital controls work in Vietnam also causes problems - last year, the rate bands were not adjusted and the central bank would not sell USD [sic] at the unadjusted rates, so the market dried up.” It is not so much the regulations, but market liquidity, due to the narrow rate bands, that causes the problems. The wider 5% band may improve the situation.	LOW	HIGH
Cash controls - credit balances	There are no restrictions on foreign investors maintaining credit balances in VND, or in investing surplus cash balances in interest-bearing accounts or money market instruments.	OK	OK
Cash controls - overdrafts	Foreign investors are not allowed to overdraw their cash accounts. Pre-funding is required for all securities trades. Securities companies only accept its customers order if they have enough securities and money in their account. This regulation is intended to prevent the possibility of default.	HIGH	HIGH
Taxes	Foreign investors are taxed at the rate of 0.1% on the gross proceeds of all sale transactions of taxable bonds (i.e., principal as well as gain). Interest income received from taxable bonds is subject to a tax of 0.1% calculated on the par value (i.e., the principal amount of the bond) plus the interest amount. Effectively, all bonds are taxable. While 0.1% is relatively small, the fact that it is applied to the principal on sale of bonds discourages trading. Investors view the tax system as being complex, but this may reflect the unfamiliar rules rather than inherent complexity. There is no provision for relief at source or for reclaims.	HIGH	HIGH

continued on next page

Table 11.2 continuation

Potential Barrier Area	Current Situation	Market Assessment Questionnaire Scores	Overall Barrier Assessment
Omnibus accounts	Omnibus accounts are allowed. Global custodians and ICSDs can operate omnibus accounts provided the custodian or ICSD [international central securities depository] registers as an investor. However, there is no nominee concept in Vietnamese law.	OK	OK
Settlement cycle	The settlement cycle for bonds is T+1. Market participants have commented that it is possible for trades to be repudiated as, in law; a trade is not valid until it has been input into the Hanoi exchange system.	LOW	LOW
Message formats	SWIFT [Society for Worldwide Interbank Financial Telecommunication] message formats are not currently used by the CSD [central securities depository] or by local market participants.	LOW	LOW
Securities numbering	ISIN [International Securities Identification Number] codes are not currently used by the CSD or by local market participants. VSD [Vietnam Securities Depository] is in the process of allocating ISIN codes for Vietnamese securities. However, ISIN codes are not available until the bonds are registered at VSD.	HIGH	HIGH
Matching	There is a trade matching system but not a settlement matching system for bonds.	LOW	LOW
Dematerialisation	All bonds are now issued in dematerialised form. Existing issues must be deposited into the VSD (and dematerialised) if they are to be traded.	OK	OK
Regulatory framework	Regulations may be unclear. Different market intermediaries may interpret regulations differently. However, overall, the market is consistently moving towards international standards.	-	LOW

Please insert full citation. If database, please include date accessed. [https://wpqr1.adb.org/LotusQuickr/asean3goe/Main.nsf/h_58E34A1388F9070B48257729000C0A4E/90F408746827C16248257729000C1334/\\$file/Part3.pdf](https://wpqr1.adb.org/LotusQuickr/asean3goe/Main.nsf/h_58E34A1388F9070B48257729000C0A4E/90F408746827C16248257729000C1334/$file/Part3.pdf)

Appendix

Table A1.1 Decision on Approval of the Project for the Development of Vietnam's Capital Market up to 2010 and Outlook to 2020

<p>GOVERNMENT SOCIALIST REPUBLIC OF VIETNAM Independence - Freedom - Happiness</p> <p>No. 128-2007-QD-TTg</p> <p style="text-align: right;">Ha Noi, 2 August 2007</p> <p style="text-align: center;">DECISION ON APPROVAL OF THE PROJECT FOR DEVELOPMENT OF VIETNAM'S CAPITAL MARKET UP TO 2010 AND OUTLOOK TO 2020</p> <p style="text-align: center;">The Prime Minister</p> <p>Pursuant to the Law on Organization of the Government dated 25 December 2001; Pursuant to the Law on Securities dated 12 July 2006; Having considered the proposal of the Ministry of Finance in Submission 22-TTr-BTC dated 28 March 2007,</p> <p style="text-align: center;">Decides:</p> <p>Article 1 To approve the project on development of Vietnam's capital market up to 2010 and the outlook to 2020, with the following main particulars:</p> <p>A. Objectives</p> <p>1. General objectives:</p> <p>To develop Vietnam's capital market in which the securities market plays the dominant role in a fast, synchronous and sustainable manner; to gradually turn the capital market into an important component of the financial market, thus greatly contributing to mobilizing capital for developmental investment and economic reform; to ensure publicity and transparency and to maintain the order, safety and efficiency of the market, and to enhance management and supervision of the market; to protect the lawful rights and interests of investors; to gradually increase competitiveness and to proactively integrate into the international financial market. Targeted by 2020, Vietnam's capital market will reach the developmental level of capital markets in regional countries.</p> <p>2. Specific objectives:</p> <p>To develop a diversified capital market in order to satisfy the need for capital mobilization and investment by entities in the economy. Securities market capitalization is targeted to reach fifty (50) per cent of GDP by 2010 and seventy (70) per cent by 2020 [sic].</p> <p style="text-align: right;"><i>continued on next page</i></p>

Table A1.1 continuation

- To rationally increase the number of securities companies, fund management companies, securities investment companies etc., and to improve the quality of operation and financial capability of such companies; to diversify services provided on the market; to increase the professionalism and quality of services; and to ensure publicity, transparency and equality on the market;

- To expand the operational scope of the Securities Depository Centre; to apply international depository standards; and to effect interlinked payment transactions between the capital market and the money market;

- To gradually form a credit rating market in Vietnam. To permit qualified credit rating organizations to be established in Vietnam and to permit a number of foreign reputable credit rating organizations to conduct credit rating activities in Vietnam.

(d) To develop a network of foreign and domestic investors:

- To encourage professional investment institutions (banking, securities, insurance, etc.) to participate in investment on the market in accordance with law. To carry out the roadmap to open up the Vietnamese market for foreign institutional investors in accordance with the undertaken roadmaps;

- To diversify investment funds; to facilitate Vietnam Social Insurance, Vietnam Postal Savings and so on to make investments on the capital market; to gradually develop and diversify superannuation funds in order to mobilize capital from inhabitants participating in investment; and to encourage the establishment of foreign investment funds making long-term investments in the Vietnamese market.

(dd) To complete the legal framework and improve the effectiveness and efficiency of State administration and supervision:

- To perfect a consistent and synchronous legal system satisfying the management and supervision requirements and the needs for integration into the international and regional capital market;

- To supplement remedies to strictly deal with civil and criminal cases in order to prevent and deal with breaches on the capital market and the securities market;

- To research and perfect policies on taxes, fees and charges applicable to securities activities, and to promote long-term investment and restrict short-term investment; to moderate profit obtained from securities business, and concurrently, via the payment of taxes, fees and charges, to contribute to overseeing the activities of the securities market and each entity or member joining the market (including foreign and domestic investors);

- To apply market supervision standards in accordance with the international practice; to intensify the checking, inspection and supervision of compliance with law by members joining the market; to check and monitor marketed goods, and to ensure publicity and transparency; to strengthen the supervision and enforcement capacity of market regulatory bodies;

- To reinforce the State apparatus, improve State administration and supervision of the capital market; to gradually separate the function of administration from the function of supervision of market activities; to study as soon as practical the establishment of a national financial supervision body to assist the Prime Minister in co-ordinating policies and warning systems and in managing and supervising financial and monetary activities at a macro level.

(e) To proactively open the market and integrate into the international and regional markets:

- Step by step, to open the capital market for foreign investors in accordance with the undertaken integration roadmap and concurrently, to ensure control of capital inflows and capital outflows; to expand international co-operative activities in terms of policy consultancy, legal consultancy and market development;

- To speed up training work and to develop human resources for the capital market; to intensify dissemination of knowledge about the capital market and securities market to the public, to enterprises and economic organizations.

(g) To assure national financial security by carrying out the following actions: to efficiently supervise capital transactions; to take measures to closely control capital flows; in necessary cases to apply appropriate solutions to reduce the exchange rate and preclude market deformity and crisis risks on the market. Such solutions shall be stated in legal instruments and notified to investors and may be applied when security of the financial system is likely to be affected. To apply a special mechanism of supervision of weak intermediary institutions in order to minimise negative chain-reaction impacts on the entire system.

Article 2 Implementing organization

The Ministry of Finance shall preside over the co-ordination with ministries, ministerial equivalent bodies, Government bodies and People's Committees of provinces and cities under central authority to organize implementation of this Decision.

continued on next page

Table A1.1 continuation

Article 3

This Decision shall be of full force and effect fifteen (15) days from the date of its publication in the Official Gazette and shall replace Decision 163-2003-QĐ-TTg of the Prime Minister dated 5 August 2003 on approval of the strategy for development of the Vietnamese securities market up to 2010.

Article 4

Ministers, Heads of ministerial equivalent bodies, Heads of Government bodies, Chairmen of People's Committees of provinces and cities under central authority and Heads of relevant bodies shall be responsible for implementation of this Decision.

Prime Minister
NGUYEN TAN DUNG

Source: Hanoi Stock Exchange. http://www.hsx.vn/hsx_en/Modules/Phapquy/VAN_BAN_PHAP QUY_FILE_download.aspx?ID_FILE=1427&TEN_FILE=Dn128gv2Aug07VietnamCapitalMarket.pdf

References

Annual Report 2010 Hanoi Stock Exchange

Prof. Shigehito Inukai
Faculty of Law, Waseda University
1-6-1, Nishiwaseda, Shinjuku-ku, Tokyo, 〒169-8050
Tel & Fax (Direct): + 81-(0)3-3202-2472
Mobile: +81-(0)80-3360-7551
E-Mail: shige.inukai@me.com



VOLUME 2

Sub-Forum 2- Information on Transaction Flows and Settlement Infrastructures



Overview of Sub-Forum 2

Statement from SF2 Chairs

The Chair and Vice-chairs express their heartfelt gratitude to members and experts of the ABMF SF2 for their contributions to make this initiative fruitful. The Chair and Vice-chairs also hope to have the continuous support of the members and experts for this initiative since this report is only the first step to bring to fruition the objectives of ABMF. Last but not least, the Chair and Vice-chairs are grateful to the ADB secretariat and the SF2 team, particularly the ADB consultant for SF2, for drafting this report.

February 2012



Mr. Jong-Hyung Lee
Chair of the ABMF SF2



Ms. Margeret Mutiara Tang
Vice-chair of the ABMF SF2



Mr. Hiroshi Ikegami
Vice-chair of the ABMF SF2

Contents

Statement from SF2 Chairs.....	i
Preface.....	1
Executive Summary of SF2	3
Member List of SF2	7
A. National Members and Experts.....	7
B. International Experts.....	8
C. Observing Authorities.....	8
D. ADB Secretariat and Consultants	8

Preface

The Association of Southeast Asian Nations plus People's Republic of China, Japan, and Republic of Korea (ASEAN+3) established a forum called ASEAN+3 Bond Market Forum (ABMF) in September 2010 as a common platform to foster standardization of market practices and harmonization of regulations relating to cross-border trades in the region. ABMF reports its activities to the Task Force 3 (TF3) of the Asian Bond Markets Initiative (ABMI) under the institutional framework of the ASEAN+3 Finance Ministers Meeting. ABMF consists of two sub-forums—Sub-Forum 1 (SF1) and Sub-Forum 2 (SF2). SF1 collates and compares regulations and market practices in the region, while SF2 looks to harmonize transaction procedures and bond messages with a view to cut the costs of cross-border deals. This report focuses on the activities of SF2.

Members and experts participating in the ABMF SF2 have conducted a survey on bond markets and their infrastructures in ASEAN+3 with tremendous support from the Asian Development Bank (ADB) secretariat and consultants. The survey looked into making possible cross-border straight-through processing of bond transactions to encourage investment of ASEAN+3 monies in the region. The participants have contributed through fruitful discussions and compiled this report to be submitted to the Task Force 3 (TF3) of ABMI.

There are 13 countries and 14 economies in the ASEAN+3 including Brunei Darussalam (Brunei, BRU), the Kingdom of Cambodia (Cambodia, CAM), People's Republic of China (China, PRC), Hong Kong Special Administrative Region (Hong Kong, HKG), Republic of Indonesia (Indonesia, INO), Japan (Japan, JPN), Republic of Korea (Korea, KOR), Lao People's Democratic Republic (Lao PDR, LAO), Malaysia (Malaysia, MAL), Union of Myanmar (Myanmar, MYA), Republic of the Philippines (Philippines, PHI), Republic of Singapore (Singapore, SIN), Kingdom of Thailand (Thailand, THA), and Social Republic of Viet Nam (Viet Nam, VIE).

Ten economies out of 14 have already developed sound and robust bond markets, while four economies are planning to or are in the process of developing their markets. This report mainly discusses the harmonization and standardization of the 10 economies

with existing bond markets. Other important issues of ABMF SF2 include planning, developing and fostering the bond markets of the four economies, which are creating sound and robust bond markets in their respective countries.

This report is a preliminary result of the ABMF SF2 and consists of three parts. Part 1 provides an overview of the bond markets and their infrastructures in ASEAN+3. Part 2 reports on the issues of economies with bond markets in the region. Part 3 contains the bond-market infrastructure diagrams, domestic bond transaction flows, and cross-border bond transaction flows. Contents of the report are as follows:

Overview of Sub-Forum 2

Part 1: Bond Markets and Their Infrastructure in ASEAN+3

Part 2: Bond Markets and Their Infrastructures in Each Economy

Part 3: Bond Market Infrastructure Diagrams, Domestic Bond Transaction Flows, and Cross-border Bond Transaction Flows

Executive Summary of SF2

The Joint Ministerial Statement of the 13th Association of Southeast Asian Nations, the People's Republic of China, Japan, and the Republic of Korea (ASEAN+3) Finance Ministers' Meeting, which was held on 2 May 2010 in Tashkent, Uzbekistan, endorsed the establishment of the ASEAN+3 Bond Market Forum (ABMF) as a common platform to foster standardization of market practices and harmonization of regulations relating to cross-border bond transactions in the region. The ABMF aims to discuss various bond market issues in order to enhance the mobilization of regional savings for regional investments and to improve information flow in the markets. The ABMF consists of two forums: Sub-Forum 1 (SF1) and Sub-Forum 2 (SF2). The objective of SF1 is to close the information gap in regulations, market practices, and other areas in the region's bond markets. SF2 focuses to enhance regional straight-through processing (STP) by harmonization of transaction procedures and standardization of messages. This paper is the report about the activities of SF2 from September 2010 to December 2011.

The ABMF SF2 members and experts (ABMF SF2) discussed how to enhance regional STP of government bond transactions from trade to settlement, and conducted a survey on government bond settlement-related infrastructures, domestic bond transaction flows, and cross-border bond transaction flows. The ABMF SF2 chose delivery versus payment (DVP) as a typical transaction type to be surveyed.

Below is an overview of government bond markets in ASEAN+3.

ASEAN +3 Government Bond Market Infrastructure Diagram

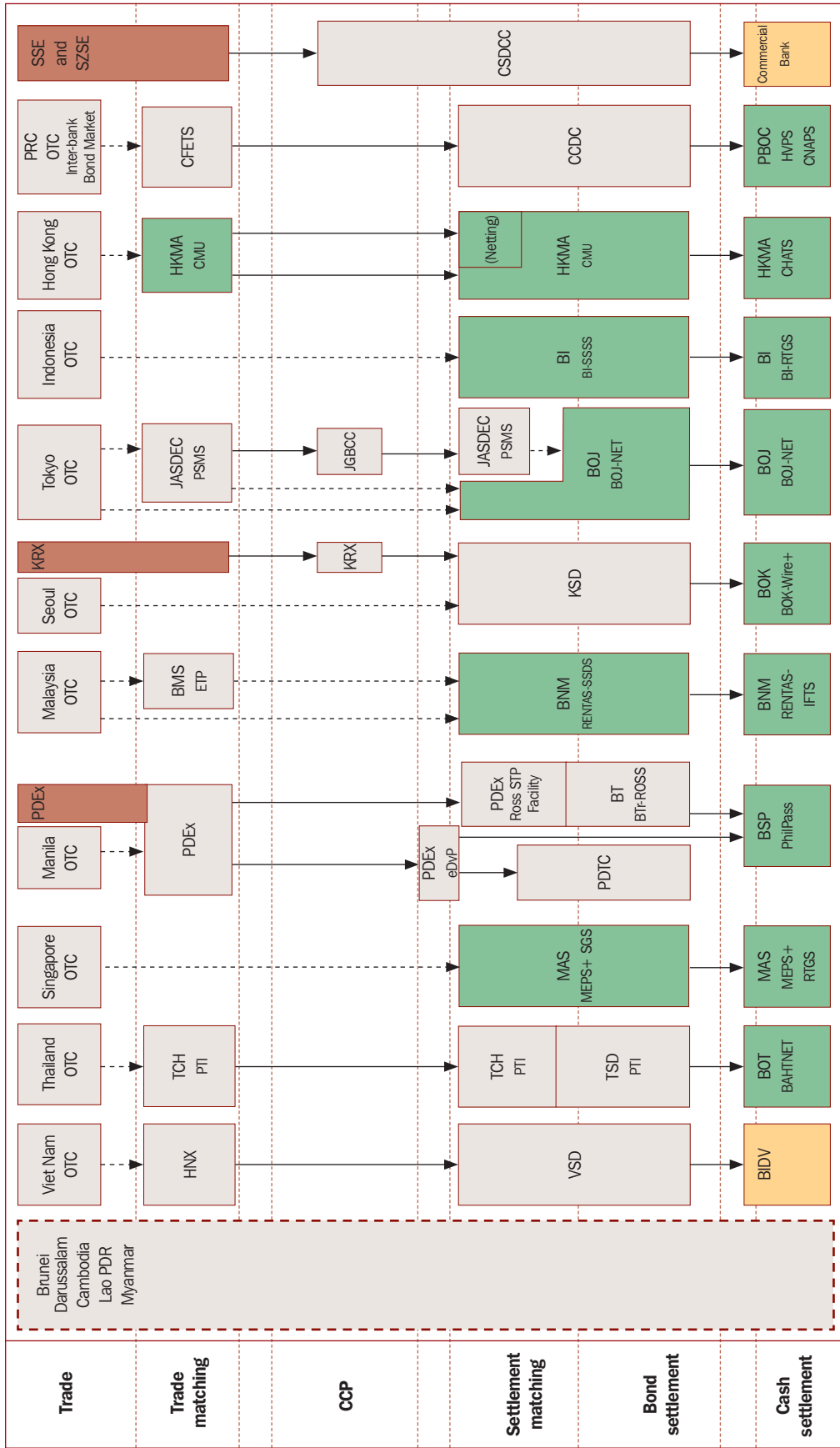

Note:
 Exchange Market
 Central Bank
 Commercial Bank

Source: ABMF SF2.

The ABMF SF2 also surveyed on matching, settlement cycle, and other issues including numbering and coding such as international securities identification number (ISIN), business identifier code (BIC), securities account number, and character code.

The ABMF SF2 compiled and discussed the survey results from the viewpoint of enhancing cross-border STP and standardization of the messages, including numbering and coding.

The following are preliminary **conclusions** of the discussions:

- 1. Robust and sound bond infrastructures.** Each market in ASEAN+3 has its own robust and sound infrastructures. Operational risks associated with the systems are comparable with those of developed markets. Each market in ASEAN+3 has its own robust and sound infrastructures.
- 2. Listed at exchanges and traded in over-the-counter (OTC) markets.** Bonds are listed at stock exchanges in many markets; however, these are mostly traded over the phone or through other communication tools by negotiation among brokers and dealers. Bond markets in the region are generally OTC markets. This is common elsewhere since bond trade is mainly quote-driven where brokers and dealers need to negotiate the price. In contrast, exchange trade is order-driven where all orders of buyers and sellers can be seen and matched by systems.
- 3. Connection between trade system and central securities depository (CSD).** In some markets in ASEAN+3, trade data are directly transmitted to CSD from the trade system to be used for bond settlement, which is efficient and effective from an STP perspective. In order to enhance STP in the region, each market is expected to automate and connect systems between trade system and book-entry system of the CSD.
- 4. Cross-border STP.** There are still comparatively few cross-border bond transactions. Almost all trade data are entered in the CSD within the borders of markets. Both trade and book-entry systems are expected to be connected multilaterally to enhance cross-border bond transactions.
- 5. Cross-border DVP.** In order to enhance cross-border STP in ASEAN+3, increasing liquidity of government bonds and currencies in the region is essential. From this perspective, ABMF SF2 members and experts are expected to further discuss fit-and-gap analysis of cross-border DVP transactions.
- 6. Matching.** All markets have a matching at a trade or settlement level, and even at both levels. Some markets adopted central matching and others local matching. In some markets, both central matching and local matching are used. Also, matching with additional features such as reduction of input workloads is implemented. Functions such as input of post-dated transaction for bond settlement book-entry systems and automated pre-settlement matching systems are expected to be implemented since manual pre-matching through facsimile and/or telephone in the region remains to be the mode of matching.

- 7. Settlement cycle.** Settlement cycles for local bond transactions in many markets are already realized at trade date + 1 (T+1), but market practices of cross-border bond transactions depend on each market player which seem to be more than T+2 and negotiable. As such, there is no standard settlement cycle in ASEAN+3. A settlement cycle, which is a rule for all market participants to observe, is expected, though not stipulated in regulation or law.
- 8. Harmonization of terminologies and definitions.** Terminologies need to be standardized before harmonizing systems and messaging in the region.
- 9. Institutional Framework.** Fostering a mutual relationship among market actors and stakeholders is important to implement a cross-border bond trade and settlement facility. To this end, there is a need to establish an institutional framework involving authorities and experts in the fields of policy, payment, information technology, and business operations to facilitate efficient communication, especially in emergencies such as [system] failures and disasters.
- 10. Reporting facility.** Most markets in ASEAN+3 are developing and improving the reporting facility of trade data to authorities including self-regulatory organizations (SROs). A data collection scheme will be very important for the entire ASEAN+3 to make markets more sound and transparent. Also, this kind of initiative may be coordinated with the activities of the ASEAN+3 Macro-economic Research Office (AMRO).
- 11. Monitoring new issues.** New issues such as new technologies and new standards including Legal Entity Identifier will be monitored to understand market trends and possible breakthrough practices.

Based on these conclusions, possible activities of the next phase of ABMF SF2, as agreed, are listed below.

1. Continuing survey of bond transaction flows, messaging, and market practices;
2. Conduct ISO 20022 fit-and-gap analysis for government bond DVP transaction;
3. Propose a possible roadmap to standardize and harmonize bond markets in ASEAN+3;
4. Prepare detailed government bond transaction flows of economies that can possibly be connected bilaterally; and
5. Provide technical assistance to economies planning to develop bond markets in ASEAN+3.

Member List of SF2

A. National Members and Experts

Economy	Membership	Institution
Brunei Darussalam	National Member	Monetary Authority of Brunei Darussalam
Cambodia	National Member	Securities and Exchange Commission of Cambodia
China, People's Rep. of	National Member	People's Bank of China
China, People's Rep. of	National Member	China Security Regulatory Commission
China, People's Rep. of	National Expert	China Securities Depository and Clearing Corporation Limited
China, People's Rep. of	National Expert	China Central Depository and Clearing Co., Ltd. (CCDC)
China, People's Rep. of	National Expert	Shanghai Clearing House (SHCH)
China, People's Rep. of	National Expert	China Foreign Exchange Trade System (CFETS)/National Interbank Funding Center (NIFC)
Hong Kong, China	National Member	Hong Kong Monetary Authority
Indonesia	National Member	Ministry of Finance
Indonesia	National Member	Indonesian Capital Market and Financial Institutions Supervisory Agency (Bapepam-LK)
Indonesia	National Member	PT Kustodian Sentral Efek Indonesia (KSEI)/ Indonesian Central Securities Depository
Indonesia	National Member	Indonesia Stock Exchange (IDX)
Japan	National Member	Japan Securities Depository Center, Inc. (JASDEC)
Japan	National Expert	Mizuho Corporate Bank, Ltd.
Korea, Rep. of	National Member	Korea Securities Depository (KSD)
Korea, Rep. of	National Expert	Korea Capital Market Institute (KCMI)
Lao PDR	National Member	Ministry of Finance
Lao PDR	National Member	Securities and Exchange Commission Office, Bank of Lao PDR
Myanmar	National Member	Central Bank of Myanmar
Philippines	National Member	Philippine Dealing System Holdings Corp (PDS Group)
Philippines	National Member	Bankers Association of the Philippines (BAP)
Thailand	National Member	The Stock Exchange of Thailand (SET)
Viet Nam	National Member	Vietnam Securities Depository (VSD)
Viet Nam	National Member	Hanoi Stock Exchange

B. International Experts

Institution	Name	Position
Citibank	Rudy Ingkiriwang	Director, Regional Network Management, Global Transaction Services
Deutsche Bank AG	Celia D. Orbeta	Direct Securities Services, Global Transaction Banking
HSBC Securities Services	Patrick Edmond Cichy	Senior Business Consultant
J.P. Morgan	Masayuki Tagai	Executive Director, Global Market Infrastructures
State Street Bank and Trust	Jonathan Rodda	(1) Director, Securities Market Practice Group (2) Vice President, State Street Bank and Trust Company
State Street Global Advisors	Hon Cheung	Regional Director - Asia, Official Institutions Group
SWIFT	Adam Wilson	Director, Securities Markets, Asia Pacific
	Alexandre Kech	Securities Standards Development
The Bank of Tokyo Mitsubishi UFJ Ltd	Taketoshi Mori	(1) Director, Securities Market Practice Group (2) Head of Securities Market Infrastructure

C. Observing Authorities

Economy	Institution	Economy	Institution
Cambodia	Ministry of Economy and Finance	Malaysia	Securities Commission Malaysia
Cambodia	National Bank of Cambodia	Philippines	Department of Finance
China, People's Rep. of	Ministry of Finance	Philippines	Bangko Sentral ng Pilipinas
Indonesia	Bank Indonesia	Singapore	Ministry of Finance
Japan	Ministry of Finance	Singapore	Monetary Authority of Singapore
Japan	Bank of Japan	Thailand	Ministry of Finance
Korea, Rep. of	Ministry of Strategy and Finance	Thailand	Bank of Thailand
Korea, Rep. of	Bank of Korea	Viet Nam	Ministry of Finance of Viet Nam
Malaysia	Bank Negara Malaysia	Viet Nam	State Bank of Viet Nam

D. ADB Secretariat and Consultants

Institution	Name	Position
ADB Secretariat	Satoru Yamadera	Economist, Office of Regional Economic Integration (-Sept. 2011) (currently Bank of Japan)
	Seung Jae Lee	Principal Financial Sector Specialist (June 2011-)
	Shinji Kawai	Senior Financial Sector Specialist (Banking) (Sept. 2011-)
ADB Consultant for SF1	Shigehito Inukai	Professor, Faculty of Law, Waseda University
ADB Consultant for SF2	Tajji Inui	Senior Manager, NTT DATA Corporation
ADB Consultant	Matthias Schmidt	Custody Business Specialist

Part 1

Bond Markets and Their Infrastructures in ASEAN+3

Contents

1. Introduction	1
1.1 Purpose of the ASEAN+3 Bond Market Forum	1
1.2 Organizational Structure and Governance	1
1.3 ASEAN+3 Bond Market Forum Sub-Forum 2.....	2
1.4 Membership and Participants.....	3
1.5 Work Steps of Sub-Forum 2	4
1.6 Schedule of Sub-Forum 2	5
2. Methodology and Approach of the Survey.....	6
2.1 Possible Goals of Sub Forum 2	6
2.2 Methodology Overview	7
2.3 Settlement Barriers Based on the Survey on the Group of Experts Report	7
2.4 Survey Questionnaire	9
2.5 Fit-and-Gap Analysis	9
3. Overview of the ASEAN +3 Bond Markets and Infrastructures	10
3.1 Overview of ASEAN+3 Government Bond Markets	10
3.2 General Observations on ASEAN+3 Bond Market Infrastructures	13
4. Domestic Bond Transaction Flow.....	13
4.1 Model Domestic Bond Transaction Flow	13
4.2 Categorization of Domestic Government Bond Transaction Flow.....	14
4.3 Settlement Instruction and Confirmation of Bond and Cash.....	16
4.4 Communication Protocol and Message Format.....	18
4.5 Reporting to Self-Regulatory Organizations for Trade Transparency	19
5. Cross-Border Bond Transaction Flow	20
5.1 Possible Channels of Cross-Border Bond Transaction Flow	20
5.2 Model Cross-Border Bond Transaction Flow	21
5.3 Some Issues on Cross-Border Bond Transactions in ASEAN+3	22

6. Matching	24
6.1 Matching Categorization	24
6.2 Matching in Each Market in ASEAN+3	25
7. Settlement Cycles and Operating Hours	
7.1 Settlement Cycles in ASEAN+3	26
7.2 Settlement Cycle as a Market Rule	27
7.3 Operating Hours	28
8. Standards on Numbering and Coding	28
8.1 General	28
8.2 Securities Numbering	30
8.3 Party Identification and Account	31
8.4 Safekeeping (Securities) Account Identification	31
8.5 Character Code and Language	32
9. Possible Next Steps	33
9.1 Overview of Possible Next Steps for the ASEAN+3 Bond Market Forum SF2	33
9.2 Scope of Fit-and-Gap Analysis	33
9.3 Drafting Roadmaps	36
9.4 Detailed Government Bond Transaction Flow	37
9.5 Technical Assistance	39
10. Conclusion	39
11. Acknowledgement	40

Figures and Tables

Figures

Figure 1.1	Organizational Structure of the ASEAN+3 Bond Market Forum	2
Figure 2.1	Possible Goals of Sub-Forum 2	6
Figure 2.2	Contribution of ASEAN+3 to International Standard	6
Figure 2.3	Methodology	7
Figure 2.4	Barriers Related to Sub-Forum 2 in the ASEAN+3 Bond Markets	7
Figure 2.5	ISO20022 and Central Securities Depository Messages	10
Figure 3.1	ASEAN+3 Government Bond Market Infrastructure Diagram	11
Figure 4.1	Model Domestic Bond Transaction Flow (1)	14
Figure 4.2	Model Domestic Bond Transaction Flow (2)	15
Figure 4.3	Model Domestic Bond Transaction Flow (3)	16
Figure 4.4	Network Between Market Participants	19
Figure 5.1	Possible Channels of Bond Transaction Flow	20
Figure 5.2	An Overview of Custodian Model	21
Figure 6.1	Trade Matching and Settlement Matching Processes	24
Figure 8.1	Standard of Numbering and Coding	29
Figure 8.2	ISIN Code Structure of Government Bonds (example)	30
Figure 8.3	Code Structure of ISO 9362	31

Figure 8.4	Safekeeping Account (example)	32
Figure 8.5	Sample Character Code and Language in ASEAN+3	32
Figure 9.1	Conversion at Local Custodian	34
Figure 9.2	Scope of Standardization	34
Figure 9.3	No Conversion	35
Figure 9.4	Mapping ISO20022 with Conventional Local Standard	35
Figure 9.5	Roadmap (Master Plan) Image	36
Figure 9.6	Future Image of Regional Settlement Intermediaries	37
Figure 9.7	Example of Detailed Bond Transaction Flow	38
Figure A1.1	Model Cross-Border Bond Flow	54

Tables

Table 1.1	Schedule of Sub-Forum 2	5
Table 4.1	Settlement Instruction and Confirmation of Bond and Cash	16
Table 4.2	Protocols and Message Formats in ASEAN+3 Bond Markets	18
Table 4.3	Reporting Rules in ASEAN+3 Markets	19
Table 6.1	Matching Types in ASEAN+3 Markets	25
Table 7.1	Settlement Cycles in ASEAN+3 (based on each market practice and definitions)	26
Table 7.2	Operating Hours in ASEAN+3	28
Table 8.1	Numbers and Codes in ASEAN+3 Markets	29
Table 8.2	ANNA Members in ASEAN+3	30
Table A1.1	Bond Market Infrastructures in ASEAN+3	48
Table A1.2	Central Securities Depositories in ASEAN+3	50
Table A1.3	Standards Including Numbering and Coding in ASEAN+3	52

1. Introduction

1.1 Purpose of the ASEAN+3 Bond Market Forum

The ASEAN+3 Bond Market Forum (ABMF) was established in September 2010 based on the endorsement of the ASEAN+3 Finance Ministers' Meeting¹ as a common platform to foster standardization of market practices and harmonization of regulations relating to cross-border bond transaction in the region.

The ABMF is expected to discuss various bond market issues to further develop liquid and well-functioning bond markets to make cross-border bond investment and settlement both smoother and cheaper; hence, the region's abundant savings are channeled more effectively into the region's increasing investment needs.

The ABMF aims to: (i) assess the existing regulatory frameworks and identify recommendations on how to foster harmonization of regulations and market practices that facilitate cross-border bond transactions in the region; (ii) enhance dialogue between the private sector and ASEAN+3 officials to develop bond markets in the region and promote harmonization, standardization, and integration; and (iii) provide opportunities to exchange knowledge, expertise, and experience between the private and public sectors in the region.

The ABMF takes stock of the Group of Experts (GoE) report, which recommends improving information flows to foreign investors to narrow the information gap by facilitating access to information on regulations.² The GoE also proposes to start discussions on the settlement barriers among private sector experts.

1.2 Organizational Structure and Governance

The ABMF is organized under Task Force 3 (TF3) of the Asian Bond Markets Initiative (ABMI). The ABMF consults with the co-chairs of TF3 occasionally in undertaking any regional activities, and reports to TF3 on a regular basis regarding the progress of its activities. The organizational structure of ABMF is shown as follows.

¹ The Joint Ministerial Statement of the 13th ASEAN+3 Finance Ministers' Meeting, 2 May 2010, Tashkent, Uzbekistan states that: "We [ASEAN+3 Finance Ministers] took note of the Group of Experts' findings and suggestions on facilitating cross-border bond transactions and settlement, and welcomed the establishment of the technical working group on Regional Settlement Intermediary (RSI) to further evaluate the policy recommendations. We endorsed the establishment of ASEAN+3 Bond Market Forum (ABMF) as a common platform to foster standardization of market practices and harmonization of regulations relating to cross-border bond transactions in the region."

² ASEAN+3 Asian Bond Markets Initiatives (ABMI) Task Force 4–Group of Experts. <http://asean3goe.adb.org>

Figure 1.1 Organizational Structure of the ASEAN+3 Bond Market Forum

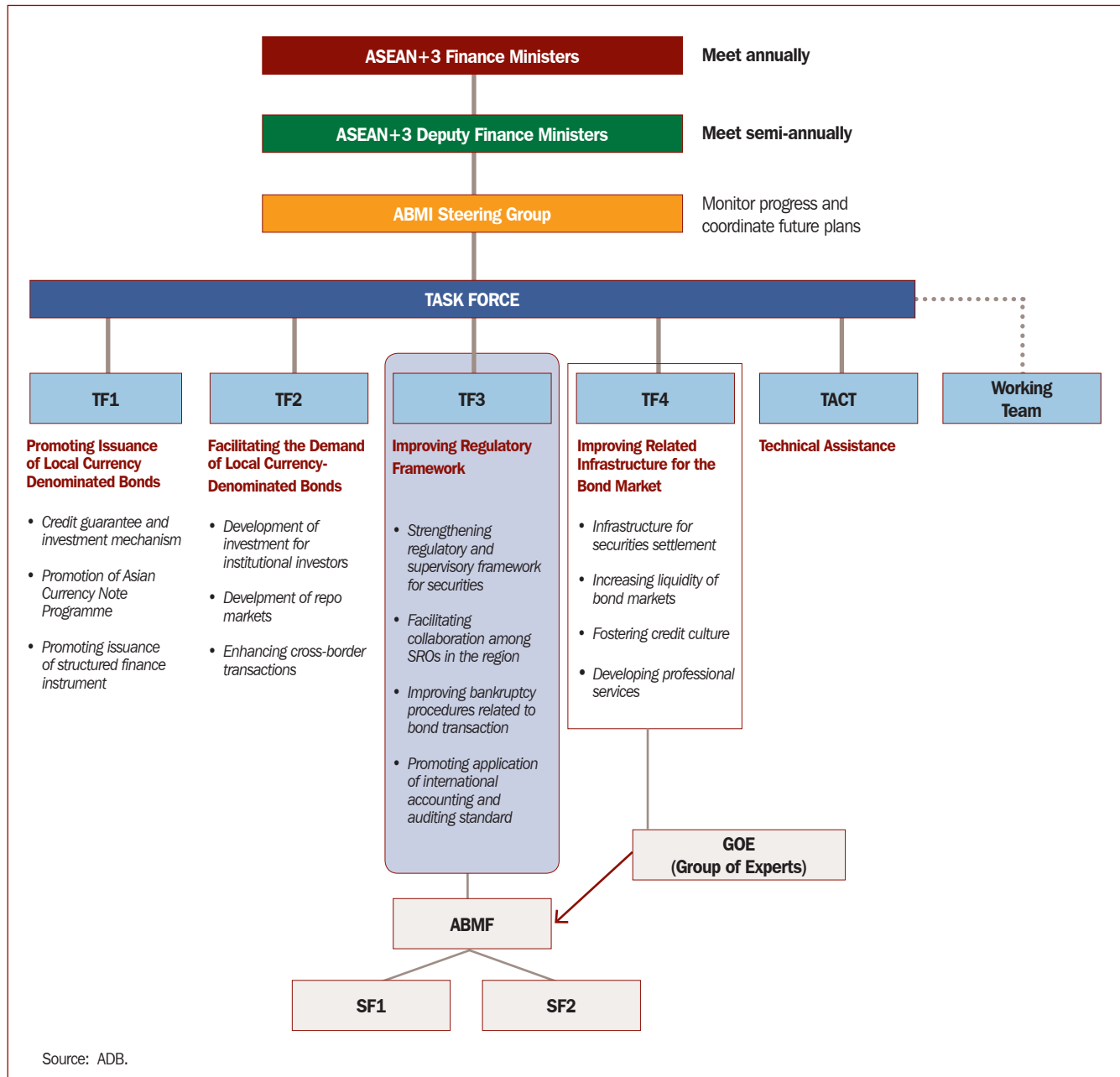

The ABMF consists of two sub-forums: Sub-Forum 1 (SF1) and Sub-Forum 2 (SF2). The objective of SF1 is to close the information gap in regulations, market practices and other areas in the region’s bond markets. SF2 focuses on enhancing straight through processing (STP) in ASEAN+3. This report is about SF2.

1.3 ASEAN+3 Bond Market Forum Sub-Forum 2

The GoE report identified various settlement barriers related to messaging formats, securities numbering, matching, and settlement cycle. Thus, the ABMF SF2 addresses these problems to enhance regional STP by harmonization of transaction procedures and standardization of messages.

It is desirable to execute cross-border transaction without any manual processes or data conversion among market infrastructures in the region. This ideal situation can be realized if all transactions are operated through a system using common standards and consistent messaging. This is not currently possible because individual countries have their own practices and standards, which is inevitable because certain transaction procedures follow national requirements to account for unique circumstances. In addition, some segments of a market may prefer ways of handling transactions, which creates differences in transaction procedures, hence, requiring additional conversion to international practices. Furthermore, differences in language remain a significant barrier as some ASEAN+3 countries use their own characters for payment systems and communication. Adopting international standards frameworks such as ISO20022 can mitigate impediments and barriers, which will enhance interoperability in ASEAN+3 bond markets.³

ABMF SF2 has mainly discussed business flows by focusing on government bond transactions, which are larger and relatively simpler compared to corporate bond transactions. Then, the discussion can be elevated to include corporate bonds, which often involve various corporate actions and other complex procedures. Transaction procedures of securities can be divided into five categories: issuances, investor registration, trades and settlements, interest payments, and redemptions. The sub-forum mainly identifies and standardizes the procedures in trades and settlements, particularly Delivery versus Payment (DVP) of government bonds. In addition, the ABMF SF2 discusses other settlement-related barriers such as securities numbering, settlement cycles, and matching to improve settlement procedures.

1.4 Membership and Participants

The ABMF consists of (i) national members, (ii) national experts, and (iii) international experts. Members and experts were selected based on issues adopted by TF3, and must have extensive knowledge of and expertise in the relevant issues. Members and experts were selected from among those actively involved in bond markets in the region including, but not limited to:

- (i) financial industry associations such as bankers' associations, securities dealers' associations, and self-regulatory organizations (SROs);
- (ii) institutional investors such as pension services, fund managers, and insurance companies;
- (iii) commercial banks and brokers;
- (iv) custodians and central securities depositories (CSDs);
- (v) rating agencies;
- (vi) financial services providers, including information technology vendors;
- (vii) financial regulators, including securities commissions;
- (viii) central banks;
- (ix) law firms; and
- (x) academics.

³ The International Standard Organization (ISO) is a worldwide federation of national standards bodies. ISO20022 provides the financial industry with a common platform for the development of messages in a standardized Extensible Markup Language (XML) syntax.

- **National Members**

The national members were nominated by each member country of TF3. In principle, the number of national members was limited to one or two persons from each country for effective communication. National members represented the opinions of their respective home markets, as opposed to the opinions of the institution to which they belong. National members were encouraged to form a preparatory working group within their respective markets.

- **National Experts**

With the consent of other national members and the endorsement of TF3, a national member nominated national experts as participants. The national experts provide insight on specific issues related to their respective markets.

- **International Experts**

With the consent of other national members and the endorsement of TF3, a national member nominates international experts as participants in the ABMF. The international experts contribute to discussions related to cross-border transactions in the region.

- **ASEAN+3 Officials**

ASEAN+3 officials participated in any ABMF meeting as an observer. The Chairpersons of the ABMF also invited ASEAN+3 officials from finance ministries, regulatory agencies, security commissions, central banks, and debt management offices and/or relevant sections for issuing public debts, if necessary.

- **Asian Development Bank**

The Asian Development Bank is a member of the ABMF as the Secretariat.

1.5 Work Steps of Sub-Forum 2

In order to enhance STP, SF2 aims to clarify transaction procedures involved in cross-border government bond transactions from one end-user to another. In addition, members identify messaging standards for bond settlement. The work processes of SF2 is provided as follows.

- **STEP 1:**

SF2 members agreed on the scope of the survey. SF2 mainly covered market infrastructures and transaction procedures of government bonds, particularly DVP. In addition, SF2 members agreed on the processes in collecting and sharing information on cross-border transactions.

- **STEP 2:**

The ADB consultant drafted the survey questionnaire for each region, which sought to clarify bond settlement-related infrastructures, transaction procedures, matching, settlement cycles, and other areas in the region's bond markets. It was then distributed to national members and experts for their responses.

- **STEP3:**

ADB secretariat and consultants visited each economy to validate information and data. During such visits, discussions with experts were held to collect more

information. Technical assistance was also provided to Brunei Darussalam and Lao PDR, whose bond markets are still being developed.

- **STEP4:**

The ADB consultant drafted the SF2 report using information from the questionnaire and outputs of the country visits. The report clarified infrastructures and cross-border transaction flows of government bonds, and identified similarities and differences in transaction procedures to discuss how to standardize infrastructures, transaction flows, code scheme, and other related matters.

- **STEP5:**

SF2 members came up with the report on cross-border transaction procedures of ASEAN+3 markets, which will serve as the basis of the succeeding steps for the SF2.

1.6 Schedule of Sub-Forum 2

Members and experts, including ADB consultants, discussed issues of cross-border bond transactions on ABMF meetings, which were held six times from September 2010 through December 2011. The schedule of the SF2 is shown as follows.

Table 1.1 Schedule of Sub-Forum 2

Date	Meeting Schedule	Tasks
2010	September	1st ABMF SF2 in Tokyo, Japan
	October	Preparation for questionnaire items
	November	
	December	2nd ABMF SF2 in Manila, Philippines
2011	January	Reply to questionnaire from each region
	February	3rd ABMF SF2 in Kuala Lumpur, Malaysia
	March	Survey of bond transaction flows of each region
	April	Country visits
	May	
	June	4th ABMF SF2 in Jeju, Republic of Korea
	July	
	August	Supplement survey Draft of this report
	September	5th ABMF SF2 in Bali, Indonesia
	October	Finishing the report
	November	
	December	

Source: ABMF.

2. Methodology and Approach of the Survey

2.1 Possible Goals of Sub Forum 2

ASEAN+3 proprietary practices (local standards) demonstrate differences from international standards, including ISO 20022. Also, proprietary practices of ASEAN+3 are different from country to country and market to market.

Figure 2.1 Possible Goals of Sub-Forum 2

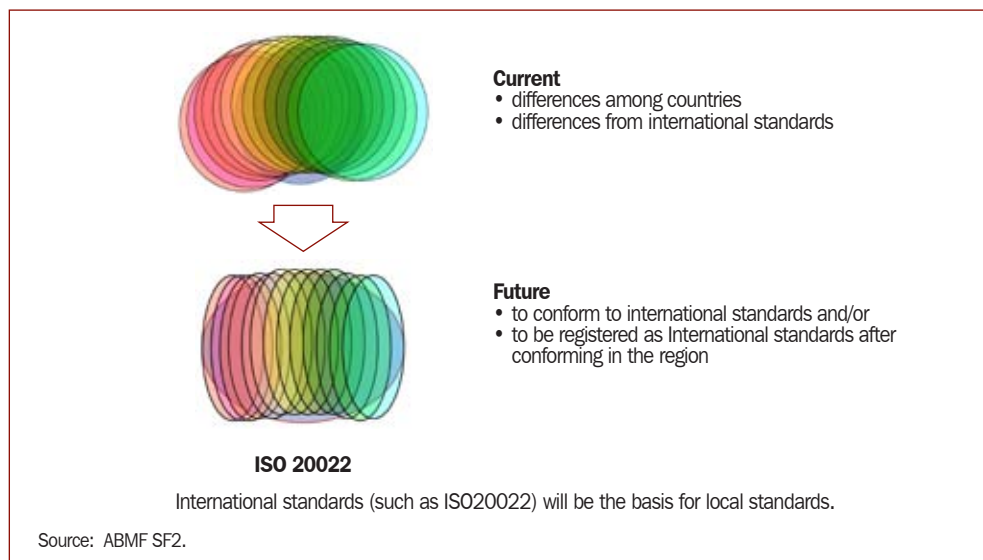

Therefore, proprietary practices of ASEAN+3 could be changed to meet international standards. It is important to harmonize practices in the region to make the differences narrower. International standards (such as ISO 20022) should form the basis of local standards to make harmonization a reality. Also, practices in the ASEAN+3 that have been identified as at par with international standards should be considered as a benchmark as well.

In other words, ASEAN+3 should engage more discussions in international forums on standard setting.

Figure 2.2 Contribution of ASEAN+3 to International Standard

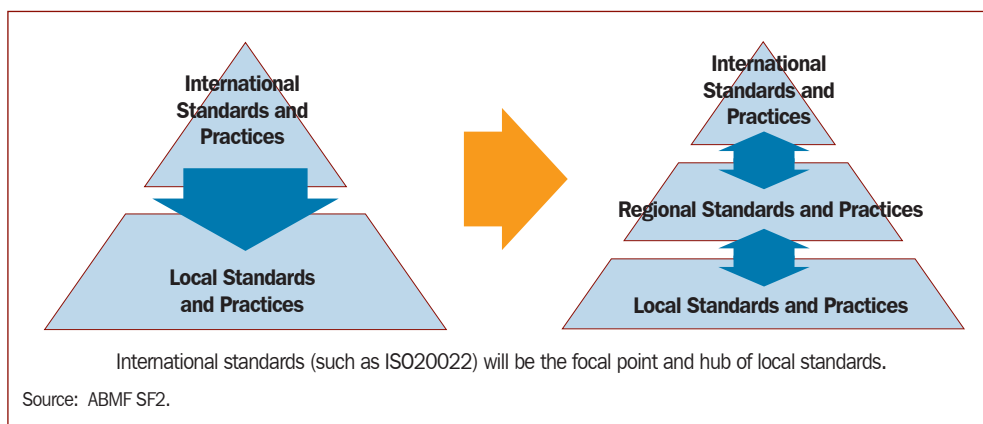

2.2 Methodology Overview

Figure 2.3 Methodology

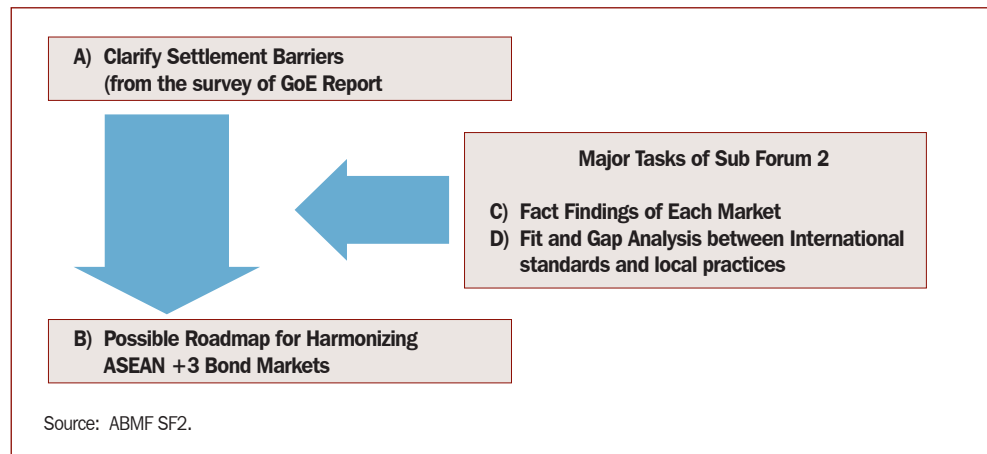

To facilitate the discussion on STP in ASEAN+3, a survey was conducted to examine the current status of government bond markets and their infrastructures. The SF2 conducted the survey based on the output of the GoE Report. As such, the major tasks of the forum included taking stock of government bond-related matters in each market, specifically on related stakeholders, and domestic and cross-border transaction flows. Fit-and-gap analysis between international standards and local practices had to be carried out to actually implement STP in the region.

2.3 Settlement Barriers Based on the Survey on the Group of Experts Report

The GoE Report pointed out the barriers to implement STP in bond markets in ASEAN+3, which is shown in Figure 2.4.

Figure 2.4 Barriers Related to Sub-Forum 2 in the ASEAN+3 Bond Markets

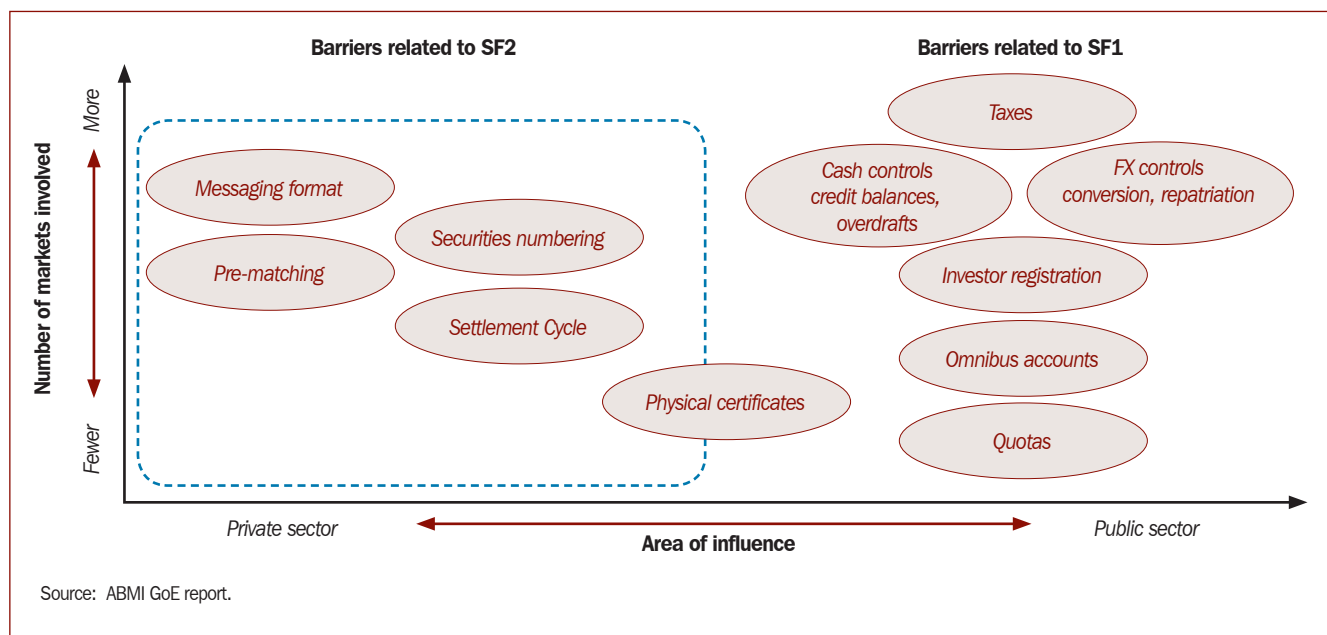

Settlement-related barriers, including messaging standards, pre-matching, securities numbering, settlement cycle, and physical certificates, are discussed in the succeeding section of this report.

1) Messaging Standards

Messaging standards refer to the use (or non-use) of international standards for securities messaging in a local market. International standards, such as ISO20022, are regarded as necessary for enabling STP in securities post-trade processing. Where local proprietary practices are implemented, this revealed the need for interface and translation either at the level of the global custodian or the local custodian. This came with associated costs of development and maintenance, as well as greater risk of error. In some cases, the local CSD does not use ISO messaging standards.

2) Trade and Settlement Matching

This refers to the matching of trade details between counterparties. Matching may take two forms: trade matching and settlement matching.

- a) **Trade matching.** Details of the trade are compared between the counterparties to ensure that there is no misunderstanding of the terms of the trade. This should be performed as soon as after the trade is executed, and, in any event, before the end of the business day. With automated trading systems (e.g., exchange systems or electronic OTC systems) matching is done at the time of trade, so there is no need for subsequent trade matching. However, many bond trades are done by telephone.
- b) **Settlement matching.** Details of the agreed trade are compared between the counterparties' settlement agents (e.g., local custodian and local broker) to ensure that all information needed for settlement is in place.

Most markets in ASEAN+3 operate some form of automated matching systems but some do not. The absence of automated matching is likely to lead to increased settlement failures and make it more difficult to shorten the settlement cycle.

3) Securities Numbering

This refers to the use (or non-use) of International Securities Identification Number (ISIN) in accordance with ISO 6166 for securities numbering in a local market. As with securities messaging, non-use of ISIN makes STP more difficult and increases the risk of error. Most ASEAN+3 markets now have established local agencies for issuing and administering ISIN for locally issued securities. The limitations may be as follows:

- a) ISINs are not available on the issue date of the bonds, making trading and settlement more difficult.
- b) ISINs are not widely used by local market participants.
- c) ISINs are not used by local CSDs, instead local securities codes are widely used.

4) Settlement Cycle

This refers to the number of days between trade date and settlement date. Most markets operate on a standard settlement cycle. Typically this is trade date plus 1 (T+1) for government bonds, and T+2 or T+3 for corporate bonds (and equities). A short settlement cycle is better for local market participants, as it reduces counterparty risk.

However, non-resident investors may find it difficult to settle on T+1 if they or their global custodian are located in a different time zone. For this reason, such investors look for the ability to negotiate a longer settlement period (T+2 or T+3 is the favored cycle). Settlement cycle as a market rule in the region is yet to be established.

5) Physical Certificates

Most bonds today are in dematerialized form held in book-entry at the local securities depository or central bank system. Some bonds are still in paper certificate form. The disadvantage of physical certificates are obvious—the need for manual examination, risk of loss, damage or forgery, and cost of storage. Typically, these remaining physical bonds are not of great interest to cross-border investors, and are unlikely to be traded at all. The ideal situation, clearly, is dematerialization. An intermediate step is to hold physical certificates, where they exist, in vaults of local securities depository for immobilization.

2.4 Survey Questionnaire

In order to try to reach its goals, SF2 conducted a survey on the issues related to barriers by sending a questionnaire to national members and international experts. The following are the primary categories of the questionnaire:

- a) Bond market infrastructures
- b) CSDs in each country
- c) Typical business flowchart
- d) Matching
- e) Settlement cycles
- f) Standards, including numbering and coding
- g) ISO and local practices
- h) Transaction costs
- i) Medium- to long-term strategy
- j) Any other information

The detailed questionnaire is shown in Appendix 1.

The SF2 survey revealed not only message formats but also business processes, such as message transactions and message flows, that need to be integrated in the survey.

Preliminary answers for bond market infrastructures, CSDs in each country, and standards including numbering and coding are shown in Appendix 2. Survey results on typical business flowchart, matching, and settlement cycles are discussed later. ISO and the local practices, transaction costs, and medium- to long-term strategy will be discussed in the next phase of the survey.

2.5 Fit-and-Gap Analysis

2.5.1 Background on Fit-and-Gap Analysis of Bond Transactions

Interoperability among bond trade, settlement systems, and infrastructures are very important to bring to fruition STP of bond transactions. In fact, some CSDs in ASEAN+3 have already adopted the ISO standard as their message standard when they reconstruct or upgrade their bond settlement infrastructures. However, not all CSDs and

bond trade and settlement-related infrastructures are compliant with the international standard yet. Also, there remain some differences between infrastructures, which have already adopted the ISO standard for their message format.

Figure 2.5 ISO20022 and Central Securities Depository Messages

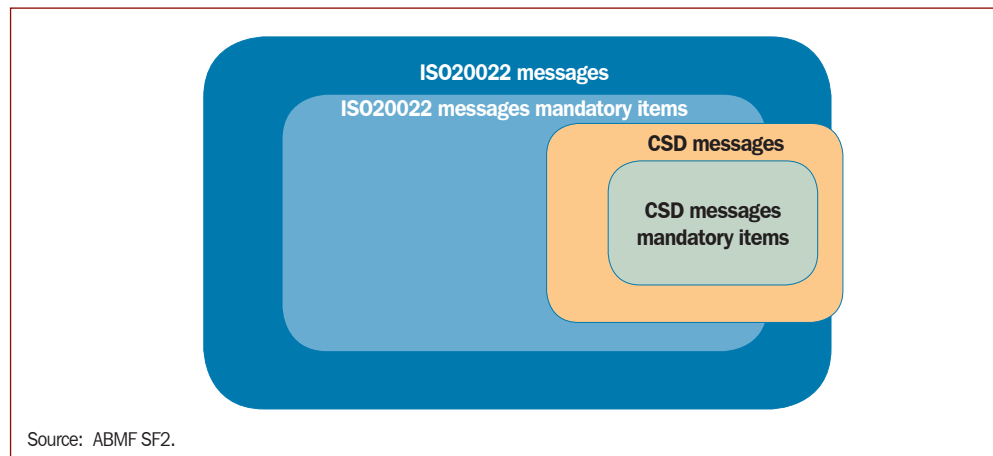

As such, there are some differences in proprietary CSD messages and ISO 20022 messages in some markets that do not follow the international standard. Also, bond trade and settlement-related infrastructures, including CSDs that have already implemented the ISO standards as their message standard, may still have their own proprietary flows and processes, which may be better than the ISO standards.

Therefore, a fit-and-gap analysis between bond transactions of each market and international standards is one of the most important steps to harmonize bond markets in ASEAN+3.

2.5.2 Scope of Fit-and-Gap Analysis

There are some levels in doing the fit-and-gap analysis of messages. A fundamental level is to check whether or not the business flow requiring a specific message exists. More specifically, it checks whether basic messages, such as bond settlement instructions and confirmation, need to be compared. Another important part of the analysis is to compare bond transaction flows. After conducting the basic fit-and-gap analysis, message items and formats may be compared and analyzed.

As a preliminary stage of the survey, a fit-and-gap analysis of messages and their flow were conducted. In order to do that, cross-border bond transaction flows and domestic bond transaction flows were surveyed.

3. Overview of the ASEAN +3 Bond Markets and Infrastructures

3.1 Overview of ASEAN+3 Government Bond Markets

This section discusses the ASEAN+3 government bond markets and their infrastructures. An overview of the markets is shown in Figure 3.1.

Figure 3.1 ASEAN + 3 Government Bond Market Infrastructure Diagram

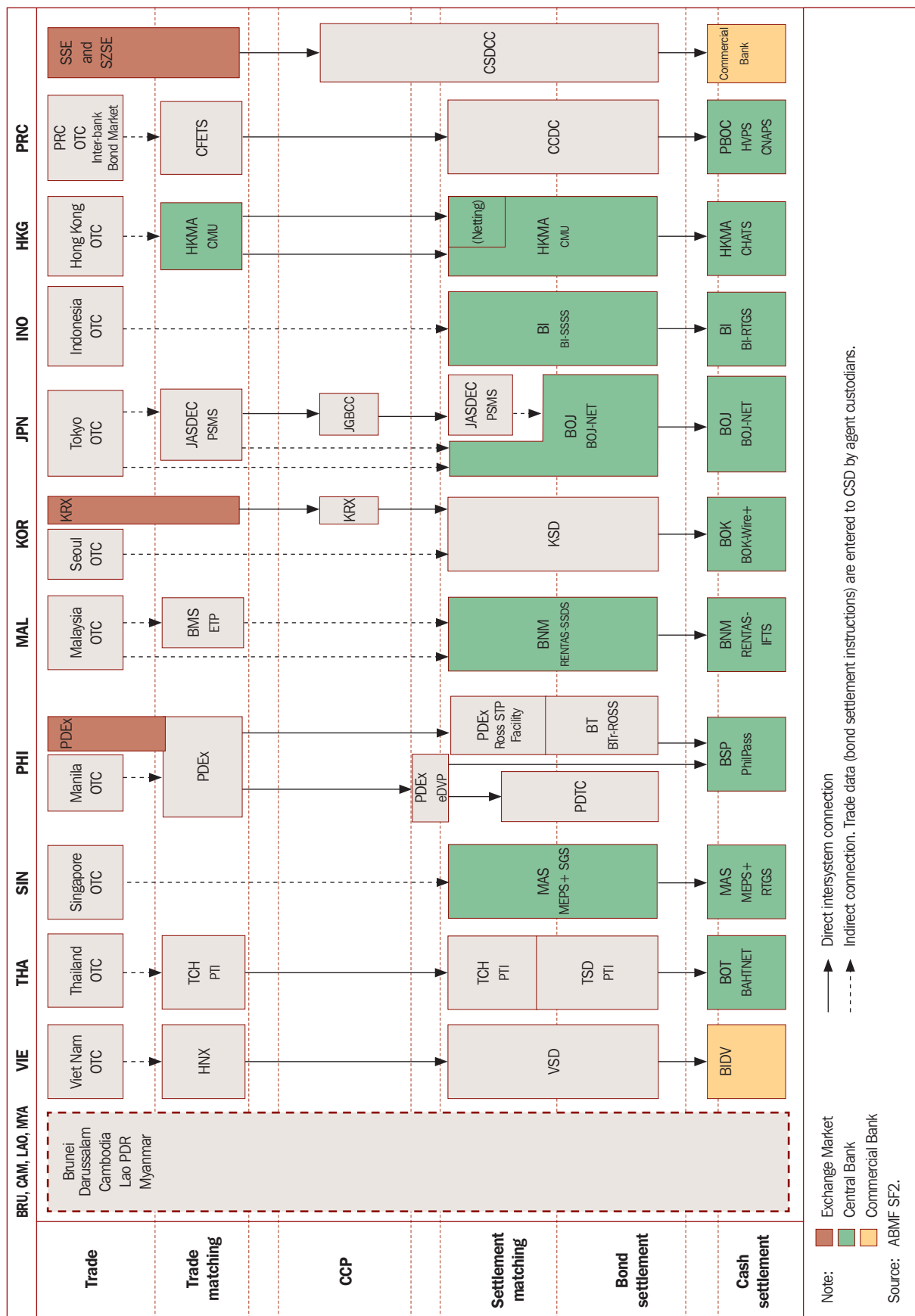

In the ASEAN+3, most countries have already developed their respective government bond markets, with the exception of Brunei Darussalam, Cambodia, Lao PDR, and Myanmar. In all the countries and economies with developed bond markets, government bonds are mainly traded in over-the-counter (OTC) markets. In a few countries including Korea and the Philippines, significant volume and value of government bonds are traded on exchanges. In China, only a small percentage of government bonds are traded on exchanges, and non-residents, known as Qualified Foreign Institutional Investors (QFII), have access to the Shanghai Stock Exchange and Shenzhen Stock Exchange.

In China, Hong Kong, Japan, Malaysia, the Philippines, Thailand, and Viet Nam, traded data are entered into trade or post-trade infrastructures such as trade-matching systems.⁴ Data entered into these trade-related infrastructures are transmitted to CSDs in China, Hong Kong, Korea (in the KRX), the Philippines, Thailand, and Viet Nam.

Two economies—Korea (KRX) and Japan (Japan Government Bond Clearing Corporation [JGBCC])—have established a central counterparty (CCP) for bond trades in ASEAN+3. A new CCP has started its operation in December 2011 in China (through the Shanghai Clearing House [SHCH]). However, the CCP is utilized only for domestic transactions in each region.

In Hong Kong, Indonesia, Japan, Malaysia, and Singapore, central banks operate the CSD. Cash settlement of government bond delivery-versus-payment (DVP) transactions is provided by central banks, except for Viet Nam.

In the region, almost all bond transactions practically stay within the economies and not reach other markets outside the country's borders. This means there are still comparatively small cross-border transactions in the region.

Generally, bond settlement systems and cash settlement systems are connected directly for the sake of DVP settlement. In the Philippines, there is unique system structure where the Philippine Dealing and Exchange Corporation (PDEx) controls all DVP settlement processes; therefore, the system structure is different from that of other markets. All markets, except for Viet Nam, provide real-time gross settlements for government bonds by using central bank money in the form of DVP Model 1 as defined by the Bank for International Settlements (BIS).⁵ In Viet Nam, all trades are settled by using commercial bank money after netting. Currently, it is planning to reconstruct its bond market infrastructures.

⁴ In general, only domestic transactions use the trade-matching system. Therefore, cross-border bond transaction go directly to the settlement-matching system or CSD.

⁵ **Model 1** is defined as system that settles transfer instructions for both securities and funds on a trade-by-trade (gross) basis, with final (unconditional) transfer of securities from the seller to the buyer (delivery) occurring at the same time as final transfer of funds from the buyer to the seller (payment); **Model 2** is defined as the system that settles securities transfer instructions on a gross basis with final transfer of securities from the seller to the buyer (delivery) occurring throughout the processing cycle, but settle funds transfer instructions on a net basis, with final transfer of funds from the buyer to the seller (payment) occurring at the end of the processing cycle; and **Model 3** is the system that settles transfer instructions for both securities and funds on a net basis, with final transfers of both securities and funds occurring at the end of the processing cycle.

3.2 General Observations on ASEAN+3 Bond Market Infrastructures

- a) **Robust and sound bond infrastructures.** Each market in ASEAN+3 has its own robust and sound infrastructures. Operational risk associated with the systems is comparable with those of developed markets.
- b) **Listed at exchanges and traded in OTC markets.** Bonds are listed at stock exchanges; however, these are mostly traded over the phone or through other communication tools by negotiation among brokers and dealers. Bond markets in the region are generally OTC markets. This is also common elsewhere since bond trade is normally quote driven where dealers need to negotiate the price. In contrast, exchange trade is order-driven where all orders of buyers and sellers can be seen and matched by the system. Korea and the Philippines are the only exception, where the exchange has a substantial market share because benchmark bonds are mostly traded at the exchange. In China, bond trades at the stock exchanges are very limited; foreign investors, who are classified as QFII, can trade bonds at the exchanges.
- c) **Central counterparty.** A central counterparty (CCP) for bond trades does not exist in many markets. However, this is understandable because transaction volume is still limited in these markets. As trade volume increases, it is expected that CCP will be introduced into the markets when needed.
- d) **Matching.** All markets have a concept of matching at a trade or settlement level, or even at both levels. Some markets adopt central matching while others do local matching. Also, matching with additional features, such as reduction of input workloads, is implemented in some markets. However, there is a need to automate manual pre-matching.
- e) **Settlement cycle.** Settlement cycles for domestic bond transactions in many markets are already realized at T+1, but market practices of cross-border bond transactions depend on each market player, which are more than T+2 and negotiable. Settlement cycle as a market rule still needs to be discussed.
- f) **Cash settlement by central bank money.** With exception of Viet Nam, all markets use central bank money to settle cash component of bond trades. In some countries, cash may be settled directly through accounts of individual financial institutions while, in the other countries, the CSD has an account with the central bank and cash is settled through the account.
- g) **Harmonization of terminologies and definitions.** Technical terminologies need to be standardized before harmonizing systems and messaging in the region.

4. Domestic Bond Transaction Flow

4.1 Model Domestic Bond Transaction Flow

This section of the report discusses the government bond transaction flows in each ASEAN+3 economy from the perspective of STP. In many markets in ASEAN+3, government bonds are mostly traded through DVP in OTC markets.⁶ A model transaction flow is chosen from among the most prevailing transaction flow, and is used as a point of comparison for the transaction flows in the different markets in the region, as demonstrated in Figure 4.1.

⁶ See Part 2 of this report.

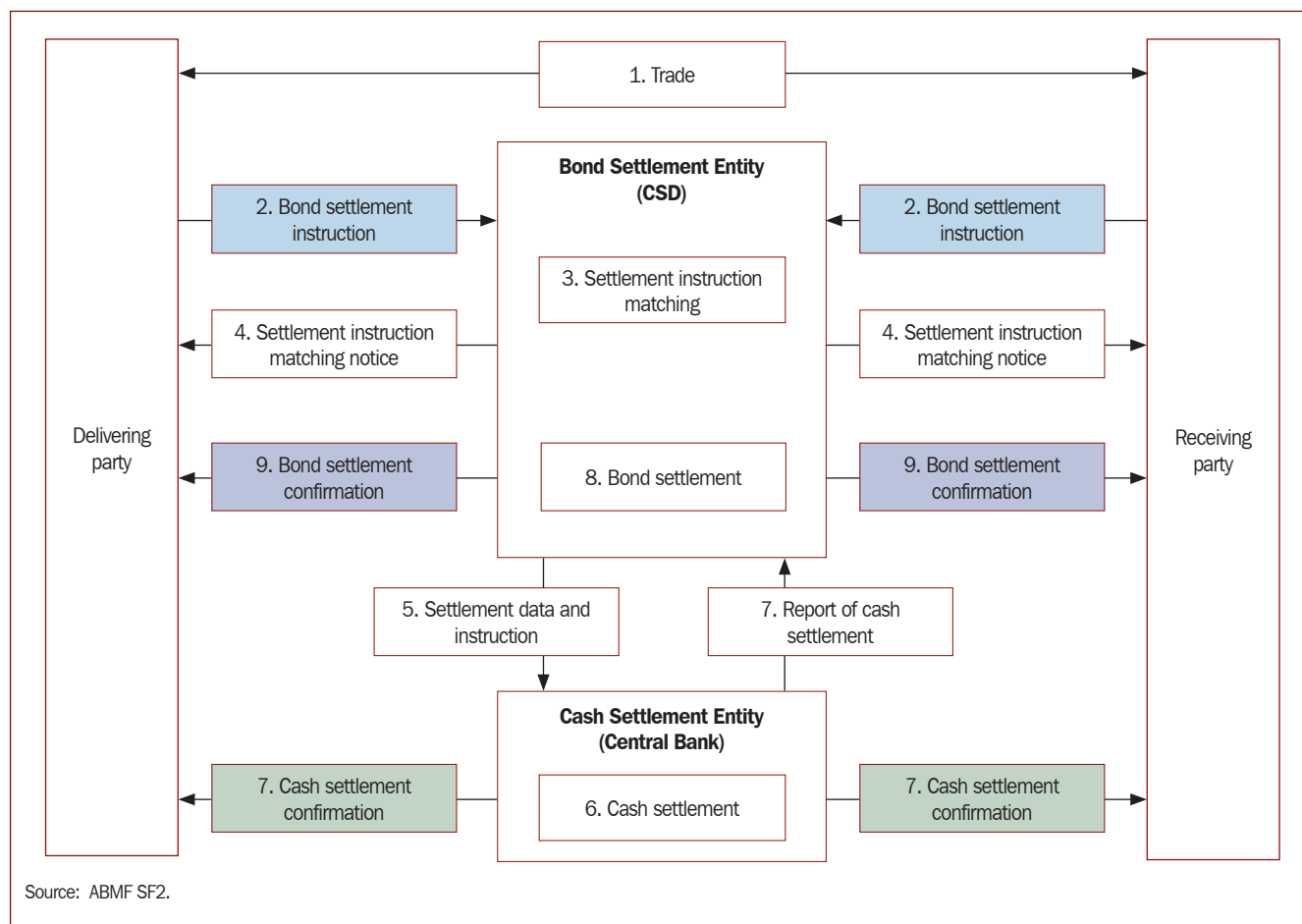
Figure 4.1 Model Domestic Bond Transaction Flow (1)

In this typical flow, market participants (seller and buyer)⁷ trade bonds by telephone, email, or other means. Then, they input the settlement instructions to the CSD directly. The CSD executes matching processes with the data sent by the seller and buyer. The results of settlement matching are sent back to the seller and buyer from the CSD. If the data are matched, the CSD continues the process and starts the DVP settlement processes. Under a DVP process, the CSD and cash settlement entity (mostly central bank in each country) execute the bond settlement if, only if, cash settlement is completed. Settlement data are sent to a cash settlement entity from the CSD, while the seller and buyer do not give instructions to the cash settlement entity directly. After the settlements are completed, the CSD and cash settlement entities send the settlement confirmation to the seller and buyer.

4.2 Categorization of Domestic Government Bond Transaction Flow

1) Model Flow

Government bond transaction flows in Hong Kong, Indonesia, Korea (OTC), and Thailand fall into the model flow.

⁷ Seller means delivering party of the bond. Buyer means receiving party of the bond.

2) Transmitting Trade Data from the Trade System to the Central Securities Depository

China's OTC market is similar to the model, but has STP function transmitting trade data directly from the trade platform of the China Foreign Exchange Trade System (CFETS) to the China Central Depository and Clearing Corporation (CCDC), which is a CSD as shown in Figure 4.2. The Philippines and Viet Nam are similar to in terms of trade data transmission from a trade platform to a CSD. In the Philippines, PDEX facilitates (controls) all transactions to CSDs. In Viet Nam, most of the bonds are traded in the OTC market, and trade data are entered to the Hanoi Exchange (HNX). This process is similar to that of China's and Korea's exchanges.

Figure 4.2 Model Domestic Bond Transaction Flow (2)

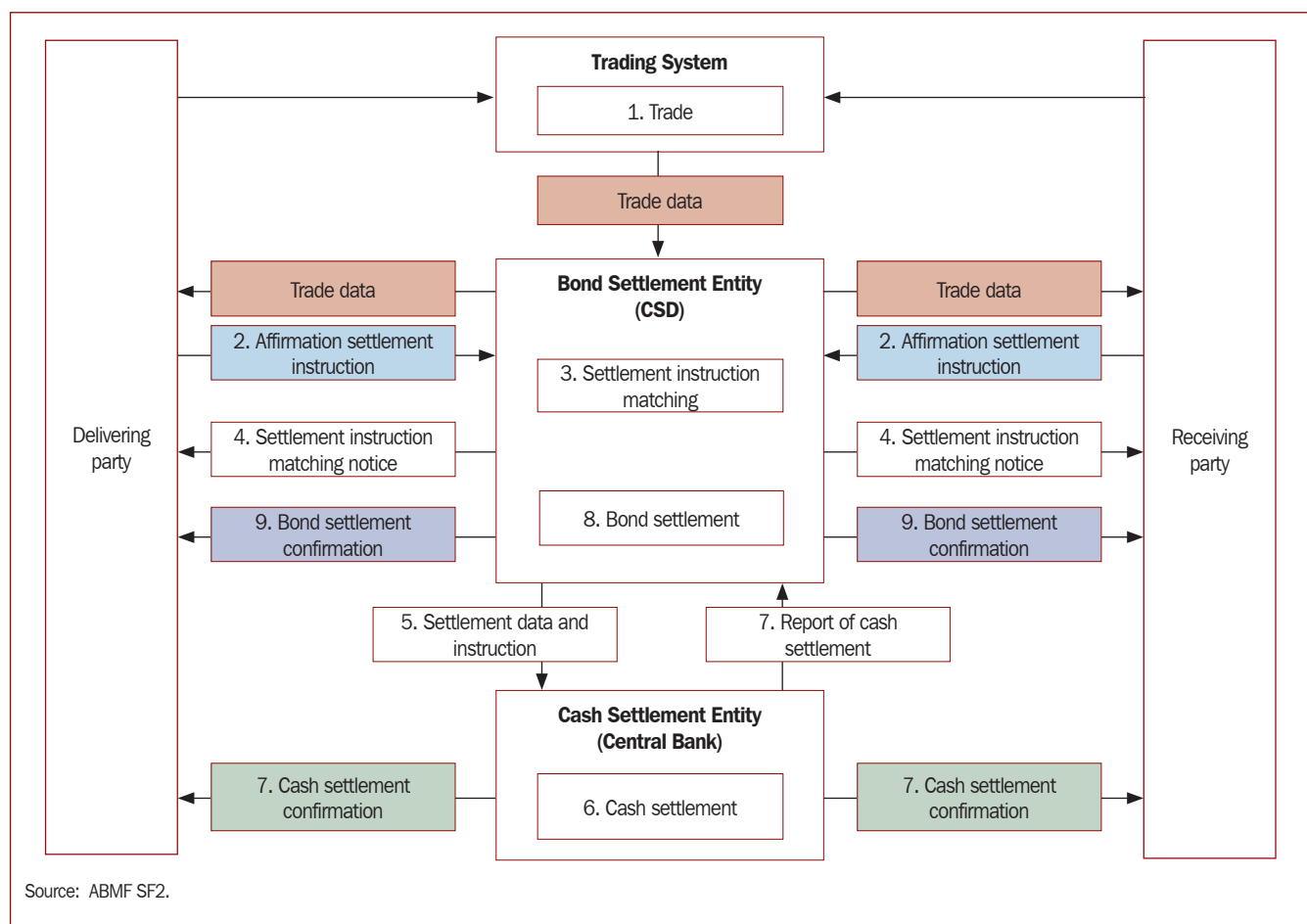

3) Local Matching and Tight Connection between Central Securities Depository and Real-Time Gross Settlement

Another variant is that the central bank owns and operates the CSD and real-time gross settlement (RTGS) systems in Japan, Malaysia, and Singapore. Either seller or buyer enters the trade data (bond settlement instruction) to the CSD, which is classified as local settlement matching as shown in Figure 4.3.

Figure 4.3 Model Domestic Bond Transaction Flow (3)

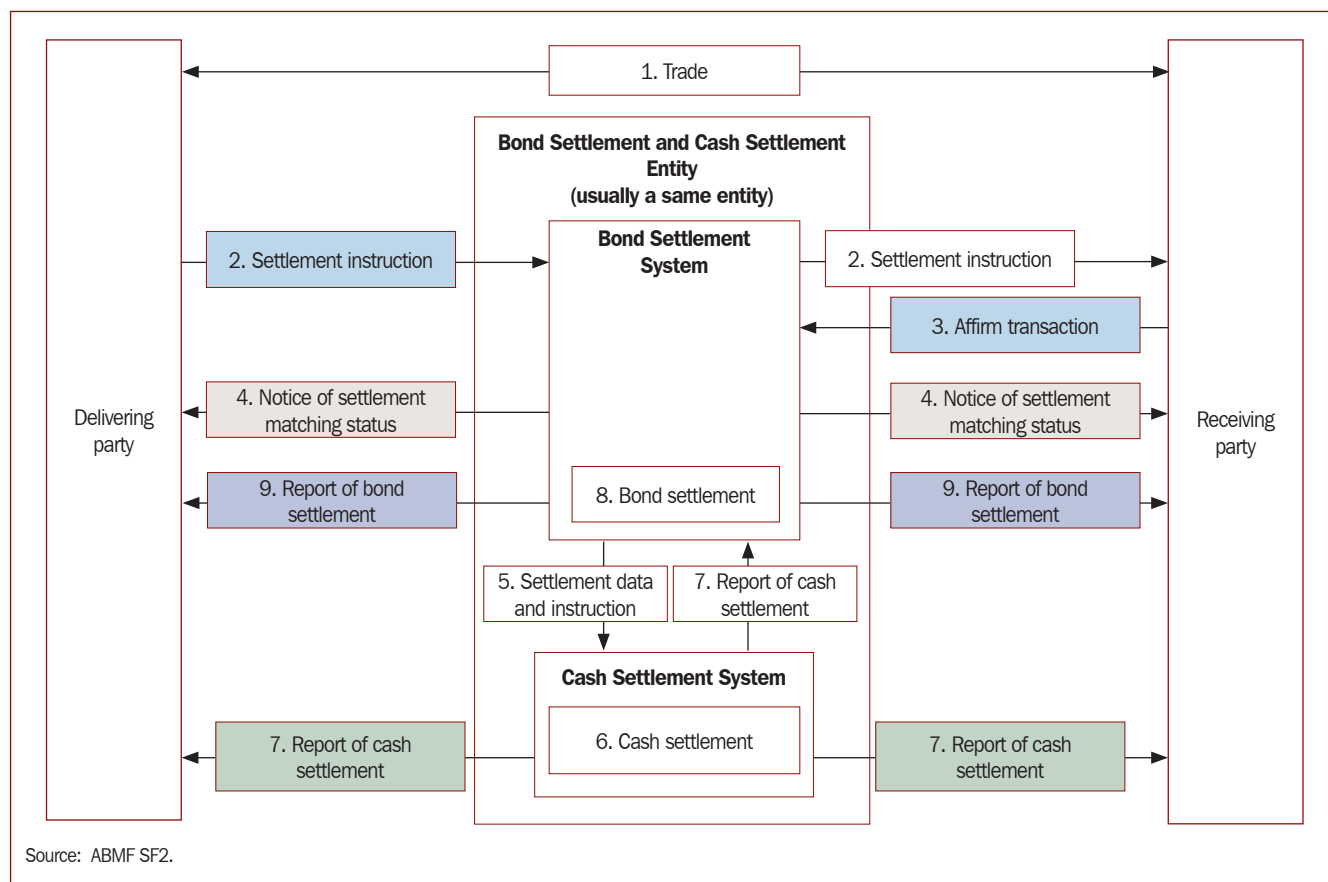

4.3 Settlement Instruction and Confirmation of Bond and Cash

Table 4.1 shows (i) transmission of trade data from trade-related platform (trading system) to the CSD, (ii) bond settlement instruction from the seller or buyer to the CSD, (iii) bond settlement confirmation from the CSD to the seller and buyer, (iv) cash settlement instruction from the buyer to the CSD, and (v) cash settlement confirmation from the CSD to the seller and buyer, in each economy by comparing the bond transaction flow with the model flow.

Table 4.1 Settlement Instruction and Confirmation of Bond and Cash

Economy	Market	Transmission of Trade Data before the Settlement Instruction	Bond Settlement Instruction	Bond Settlement Confirmation	Cash Settlement Instruction	Cash Settlement Confirmation
PRC	OTC	<ul style="list-style-type: none"> From the trading system 	<ul style="list-style-type: none"> From seller and buyer ¹ Affirmation of the settlement 	<ul style="list-style-type: none"> From CSD to seller and buyer 	<ul style="list-style-type: none"> From CSD 	<ul style="list-style-type: none"> From Central Bank to seller and buyer
	Exchange	<ul style="list-style-type: none"> From the trading system 	<ul style="list-style-type: none"> From seller and buyer Affirmation of the settlement 	<ul style="list-style-type: none"> From CSD to seller and buyer 	<ul style="list-style-type: none"> From CSD 	<ul style="list-style-type: none"> From CSD and Payment Banks to seller and buyer
HKG	OTC	<ul style="list-style-type: none"> None 	<ul style="list-style-type: none"> From seller and buyer Settlement Data and instruction 	<ul style="list-style-type: none"> From CSD to seller and buyer 	<ul style="list-style-type: none"> From CSD 	<ul style="list-style-type: none"> From Central Bank to seller and buyer
INO	OTC	<ul style="list-style-type: none"> None 	<ul style="list-style-type: none"> From seller and buyer Settlement Data and instruction 	<ul style="list-style-type: none"> From CSD to seller and buyer 	<ul style="list-style-type: none"> From CSD 	<ul style="list-style-type: none"> From Central Bank to seller and buyer

continued on next page

Table 4.1 continuation

Economy	Market	Transmission of Trade Data before the Settlement Instruction	Bond Settlement Instruction	Bond Settlement Confirmation	Cash Settlement Instruction	Cash Settlement Confirmation
JPN	OTC	• None	• Instruction from buyer (or seller) • Affirmation from seller (or buyer)	• From CSD to seller and buyer	• From buyer (or seller)	• From Central Bank to seller and buyer
KOR	OTC	• None	• From seller and buyer • Affirmation of the settlement	• From CSD to seller and buyer	• From CSD	• From Central Bank to seller and buyer
	Exchange	• None	• From the trading system • Settlement Data and instruction	• From CSD to seller and buyer	• From CSD	• From Central Bank to seller and buyer
MAL	OTC	• None	• Instruction from buyer (or seller) • Affirmation from seller (or buyer)	• From CSD to seller and buyer	• None (one entity executes both of the bond and cash settlement)	• None (integrated with the Bond Settlement Confirmation)
PHI	OTC GSED	• From the trading system	• From seller and buyer to DVP controlling system • From DVP controlling system to CSD	• From DVP controlling system to seller and buyer	• From CSD	• From Central Bank to seller and buyer
	OTC nonGSED	• From the trading system	• From seller and buyer to DVP controlling system • From DVP controlling system to CSD	• From DVP controlling system to seller and buyer	• From DVP controlling system	• From Central Bank to seller and buyer
SIN	OTC	• From seller (or buyer)	• Instruction from buyer (or seller) • Affirmation from seller (or buyer)	• From CSD to seller and buyer	• From CSD	• From cash settlement entity to seller and buyer
THA	OTC	• None	• From seller and buyer • Settlement Data and instruction	• From CSD to seller and buyer	• From CSD	• From Central Bank to seller and buyer
VIE	OTC	• From the trading system	• From seller and buyer • Affirmation of the settlement • Click on CSD's web site	• seller and buyer can refer to the status of transaction on web pages	• From CSD	• seller and buyer can refer to the status of transaction on web pages

¹ About 5% of trades are directly entered to CCDC after traded in China OTC Market. In this case, one party (either seller or buyer) needs to send settlement instruction into CCDC system. The settlement instruction needs to contain full message items necessary for the settlement. CCDC system will automatically ask the other party to confirm. If not, CCDC won't process settlement. After matching the order (local matching), CCDC will settle the trade in FOP or DVP as requested by customers.
Source: ABMF SF2.

4.3.1 Bond Settlement Instruction

In China, Korea (Exchange), the Philippines, and Viet Nam, trade data are entered from trade-related platform to the CSD directly through a network. In China, the data are forwarded to the seller and buyer to save the input workload for both. The seller and buyer send back affirmation to express their willingness to sell or buy the bond. In Korea (Exchange), the Philippines, and Viet Nam, trade data entered into the trade-related platform are directly transmitted to the CSD and regarded as bond settlement instructions for DVP. There are no explicit affirmation processes for Korea (Exchange) and the Philippines. Sellers and buyers can check transaction details from web terminals by accessing the trading system. In Viet Nam, after receiving the trade results from stock exchanges, VSD sends the notices of cash/securities multilateral netting and settlement to buying and selling members. Buying and selling members need to confirm the accuracy of trade result from their side. Based on these confirmation, VSD effects the settlement without changing the status of the transaction in the central database from members. In other markets, the seller and/or buyer need to relay the bond settlement instruction to the CSD explicitly by sending the instruction or by returning affirmation on the forwarded inquiry with trade details.

4.3.2 Bond Settlement Confirmation

In China, Hong Kong, Japan, and Korea, bond settlement confirmation is sent from the CSD to the buyer and seller. In other markets, the seller and buyer need access to the CSD, such as PDEx in the Philippines, to retrieve the result.

4.3.3 Cash Settlement Instruction

Japan and Korea need to explicitly send cash settlement instruction for DVP transactions. In other markets, receiving settlement data from the CSD (i.e., PDEx in the Philippines) is regarded as sufficient authority to debit the value of the bond from the buyer's current account.

4.3.4 Cash Settlement Confirmation

In Japan, Malaysia, and Singapore, trade data are entered into the CSD from the seller and/or buyer. Both CSDs and cash settlement entities are owned and operated by their respective central banks.

4.4 Communication Protocol and Message Format

The communication protocol between market participants and CSDs in each market is mostly transmission control protocol/Internet protocol (TCP/IP), while message formats vary from market to market, and do not have de facto standard. Most of the protocols between market participants and cash settlement entities also use TCP/IP.

Protocols and Message formats in each market are listed in the table below.

Table 4.2 Protocols and Message Formats in ASEAN+3 Bond Markets

Market	1. Between CSD and Seller/Buyer			2. Between Cash Settlement System		
	Linkage	Protocol	Message Format	Protocol	Message Format	
PRC	OTC	direct link	<ul style="list-style-type: none"> TCP/IP HTTP, SOAP 	• XML and Text	• TCP/IP	–
HKG	OTC	direct link	• TCP/IP	• ISO 15022	• TCP/IP	• SWIFT
INO	OTC	terminal access	• SNA. TCP/IP will be adopted	• Proprietary. SWIFT will be adopted.	• SNA. TCP/IP will be adopted.	Proprietary. SWIFT will be adopted.
JPN	OTC	direct link	• TCP/IP	• Proprietary. ISO20022 will be applied (CSV and XML).	• TCP/IP	Proprietary. ISO20022 will be adopted.
KOR	OTC	direct link	• TCP/IP	–	• TCP/IP	–
MAL	OTC	terminal access	• TCP/IP	–	• TCP/IP	–
PHI	OTC GSED	terminal access	<ul style="list-style-type: none"> TCP/IP HTTPS 	• Proprietary	• TCP/IP	• SWIFT
SIN	OTC	terminal access	• TCP/IP	–	• TCP/IP	–
THA	OTC	terminal access	<ul style="list-style-type: none"> TCP/IP HTTPS 	–	• TCP/IP	–

CSV = Comma Separated Value, GSED = government securities eligible dealer; HTTP = Hyper Text Transfer (or Transport) Protocol; ISO = International Organization for Standardization; OTC = over-the-counter, SNA = Systems Network Architecture; SOAP = Simple Object Access Protocol; SWIFT = Society for Worldwide Interbank Financial Telecommunication; TCP/IP = Transmission Control Protocol/Internet Protocol; XML = Extensible Markup Language
 – = no information.
 Source: ABMF SF2.

Some CSDs have direct linkages with market participant's systems. In the future, ABMF SF2 can promote to build an environment for cross-border transactions by standardizing the message format of the linkages based on international standards.

While there is little information about message formats, such standardization makes possible the reduction of systems cost of market participants. The standardization of protocols between the trading system and CSDs may be discussed in future initiatives to standardize the communication protocol in ASEAN+3 bond markets.

Figure 4.4 Network Between Market Participants

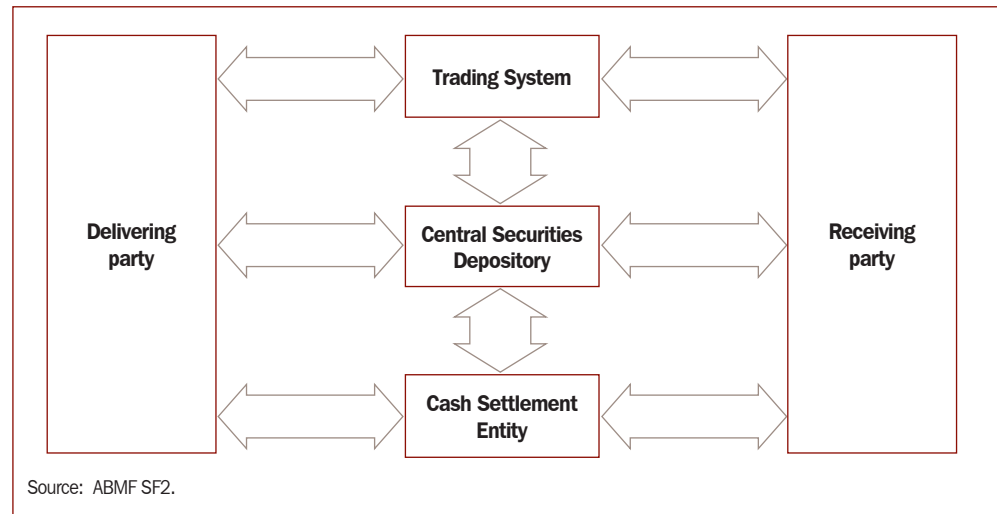

4.5 Reporting to Self-Regulatory Organizations for Trade Transparency

Some markets in ASEAN+3 have rules that market participants have to report trade data to authorities including self-regulatory organizations (SROs) for trade transparency. Some examples of such rules in the region are described as follows.

Table 4.3 Reporting Rules in ASEAN+3 Markets

Economy	Entity Which Receive a Report	Reporting Rule
PRC	China Foreign Exchange Trade System (CFETS)	The trade data are entered to CFETS for price transparency.
HK	–	–
INO	Indonesia Stock Exchange (IDX)	The seller or buyer have to report trade data to Centralized Trading Platform (CTP) of Indonesia Stock Exchange (IDX) within 30 minutes of trade.
JPN	–	–
KOR	Korea Financial Investment Association (KOFIA)	A financial investment company engaged in bond trading should report the details to KOFIA.
MAL	Bursa Malaysia (BM)	BM runs Electronic Trading Platform (ETP), and the seller and buyer have to input all trades to ETP.
PHI	Philippine Dealing and Exchange Corporation (PDEX)	The seller or buyer have to report trade data to Philippine Dealing and Exchange Corporation (PDEX).
SIN	–	–
THA	ThaiBMA	All debt securities trading transactions, wherever it is done, must be reported to the ThaiBMA. The ThaiBMA monitors the reported price data to ensure that disseminated prices are accurate to be used as market reference.
VIE	–	–

– = no information.
Source: ABMF SF2.

In Indonesia, the Indonesia Stock Exchange (IDX) functions as a bond transaction-reporting center. The seller or buyer is obliged to report trade data to the centralized trading platform (CTP) of the IDX within 30 minutes of trade.

In Korea, the Korea Financial Investment Association (KOFIA) functions as an SRO. Financial investment companies engaged in bond trading should report the details of trade to KOFIA, and KOFIA discloses this information on its website.

In Malaysia, Bursa Malaysia (BM) is an SRO responsible to improve trade transparency in the Malaysian bond market. BM runs an electronic trading platform (ETP), where the seller and buyer have to input all trades.

In Thailand, all debt securities trading transactions, wherever it is done, must be reported to the Thai Bond Market Association (ThaiBMA). The ThaiBMA monitors the reported price data to ensure that disseminated prices are accurate as market reference.

Trade data collection and reporting scheme are very important issues that need to be addressed to make ASEAN+3 markets more sound and transparent. Also, this kind of initiative may be related to the activities of the ASEAN+3 Macro-economic Research Office (AMRO).

5. Cross-Border Bond Transaction Flow

In this section, inflow investments in bonds by non-residents are discussed to illustrate a typical cross-border transaction flow. Delivery versus payment (DVP) of government bond transactions is chosen as a model of business flow, considering that the government bond is a typical bond instrument traded in the form of DVP in ASEAN+3.

5.1 Possible Channels of Cross-Border Bond Transaction Flow

In ASEAN+3, channels to buy bonds are available for investors (classified as non-residents) whose domicile is different from where the bonds are to be purchased. These channels are shown in Figure 5.1.

Figure 5.1 Possible Channels of Bond Transaction Flow

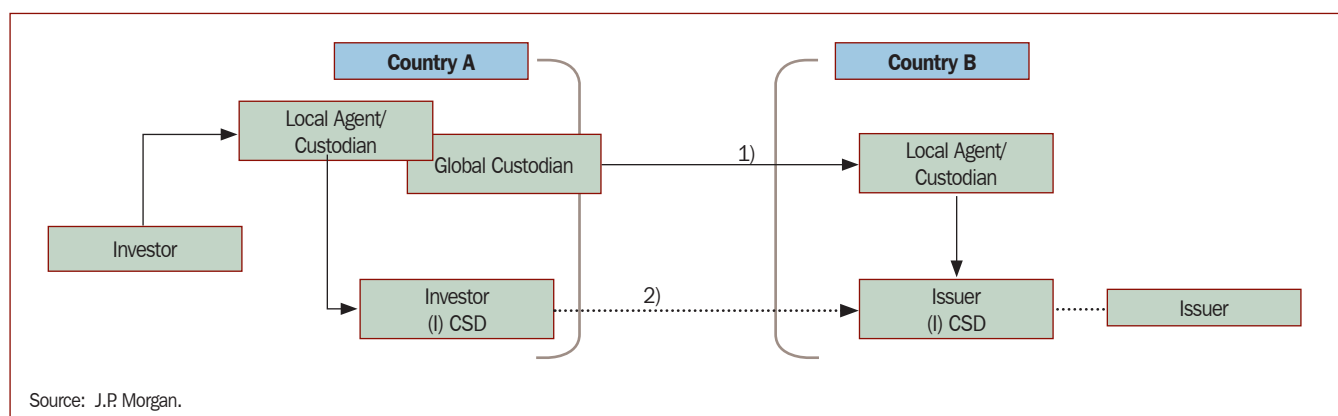

These channels include:

- 1) Local agency or custodian in country B that has direct or indirect access to the foreign (issuer) CSD;
- 2) A(n) (I)CSD that has direct or indirect access to the foreign (issuer) CSD; and

This report focuses on the channel to use a local agency or custodian since this is the most prevailing means for cross-border transactions in ASEAN+3. In this case global and local custodians play specific roles for foreign institutional investors to settle transactions in the region. An overview of global custodian model is shown in Figure 5.2.

Figure 5.2 An Overview of Custodian Model

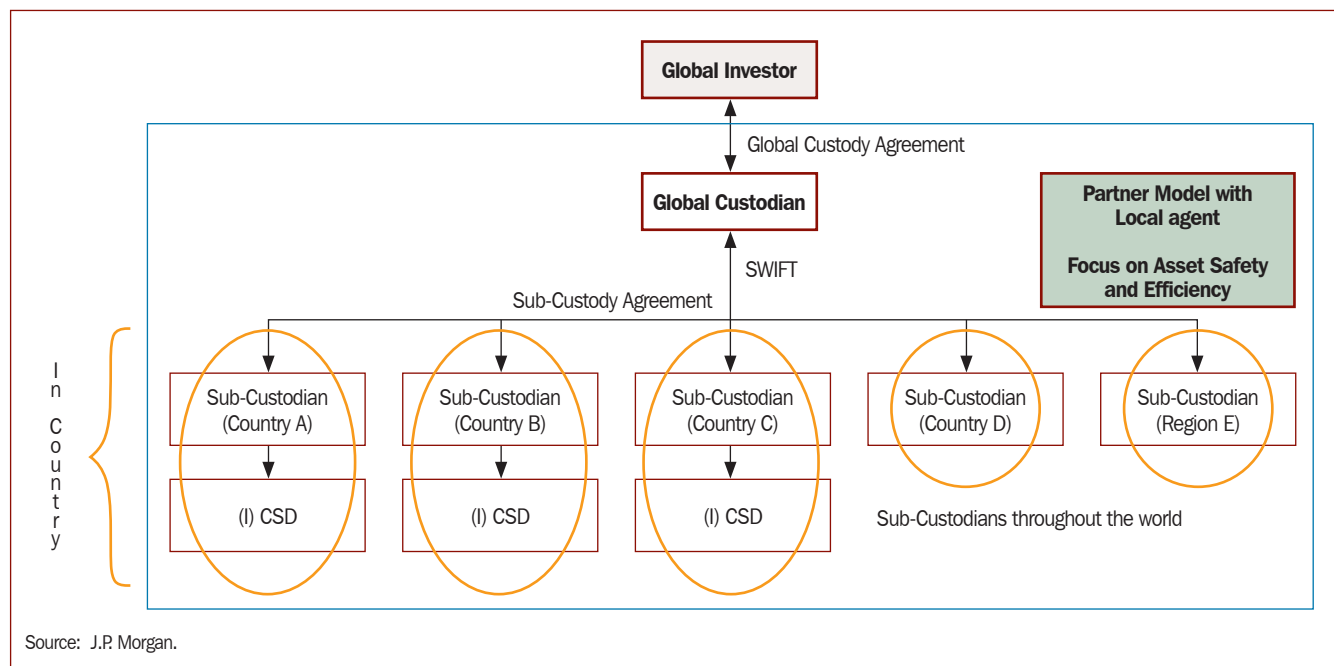

5.2 Model Cross-Border Bond Transaction Flow

A model cross-border bond transaction flow is shown in Appendix 3-1, which takes into account the situation in ASEAN+3 as discussed previously. Since bond trades and settlements are products of many elements including documented regulations, visible standards, market practices, intricacies and nuances of markets, and history, many variations of cross-border bond transaction flows can be found in the region. Therefore, the most common cross-border bond transaction flow in the region is chosen. As such, the model cross-border bond transaction flow does not necessarily represent a best-practice model, but rather the most typical flow in the region. The model bond-transaction flow is compared with the different cross-border transaction flows in ASEAN+3 to come up with harmonized bond transactions in the region.

Appendix 3-2 shows the roles and needs of the various stakeholders in cross-border bond trading and settlement, which includes foreign institutional investors, global custodians, local custodians, CSDs, and cash settlement banks.

5.3 Some Issues on Cross-Border Bond Transactions in ASEAN+3

This section discusses the impact of settlement barriers to cross-border transaction flows in each market in ASEAN+3, as identified in the GoE Report. The typical flow in each market is compared with the model cross-border bond transaction flow.

Flows related to foreign institutional investors, global custodians, and domestic custodians are also discussed in this section. This takes into account that domestic bond transaction flows take place between domestic custodian (including cash correspondent bank) and bond settlement infrastructures (including CSD and RTGS systems). Causes of additional processes in the typical transaction flow, compared with the model transaction flow, include taxes, currency exchange controls, cash controls, and foreign investor registration. Other issues such as manual pre-settlement matching are also discussed in this section.

5.3.1 Tax

In Indonesia, there are additional bond transaction flows related to capital gains tax for bond trades. When a domestic custodian conducts pre-settlement matching with a counterparty, the amount of capital gains tax is calculated and agreed with the counterparty. The information on capital gains tax is sent from the domestic custodian to the global custodian with the pre-matching status. The global custodian requests the foreign institutional investor to amend the settlement amount, taking the capital gains tax into account. The amended settlement instruction is sent from the foreign institutional investor to the global custodian, and from the global custodian to the domestic custodian for pre-settlement matching with the counterparty using amended amount.

The impact of tax on bond trades and settlements have been previously discussed in several papers, particularly on withholding tax. The withholding tax is mainly regarded as an impediment to interest payments and redemption. Therefore, the withholding tax remains one of the important challenges, though it may not have a significant negative impact on bond transaction flow for trade, particularly on DVP.

5.3.2 Currency Exchange and Cash Controls

Currency exchange controls and cash controls are related to the level of currency convertibility and policy of regulators, including monetary authorities and central banks. In China, Indonesia, Malaysia, the Philippines, Thailand, and Viet Nam, real-demand principle for obtaining local currency in the foreign exchange regime exists. Also, in some countries, there are controls over the local currency credit facilities imposed on non-residents. In China, lending to non-residents (overseas institutions), or contracting foreign credit, is restricted to financial institutions authorized by the People's Bank of China. In Indonesia, foreign exchange transactions need to be executed through banks incorporated in Indonesia and licensed by Bank Indonesia. In Korea, credits and loans worth more than KRW1 billion (a borrower denominated in local currency and granted by institutional investor) require the Bank of Korea's approval. Korean law also prohibits extending credit for speculation purposes to non-residents. In Malaysia, banking institutions may extend credit facilities up to an aggregate limit of MYR10 million to a non-resident for any use in Malaysia other than for financing purposes or construction of immovable properties. In the Philippines, peso loans to non-residents by resident banks are not allowed under local central bank regulations. Overdraft is also not allowed. FX swaps with non-residents require prior central bank approval. Foreign portfolio investments are required to be registered with central bank

if FX will be sourced from any authorised agent banks in case of repatriation of FX equivalent for any future peso sale proceeds or peso interest income. In Singapore, credit facilities exceeding SGD\$5 million to non-resident financial entities for speculation purposes are not allowed. Overdraft to non-residents is not allowed either. In Thailand, overdraft facilities provided by domestic financial institutions to foreign investors are capped at THB30 million per non-resident investor per financial institution.

Though these issues may not have a direct impact on bond transaction flows, there is a need for foreign exchange advice and confirmation. When buyer is paying with local currency of relatively low convertibility, some additional bond transaction flows such as pre-funding and foreign exchange confirmation are necessary. In China and Viet Nam, pre-funding is required to secure sufficient funds in domestic custodians (cash correspondents) of the buyer before the foreign institutional investor effects trade order to the broker. In China, domestic custodian of a qualified foreign institutional investor (QFII) sends a cash-projection report to the designated QFII broker. In Viet Nam, foreign institutional investors send foreign exchange funding instructions to global custodians. Then, the global custodians send the instructions to domestic custodians to pre-fund cash before trade orders are sent from the investors to the global brokers. In Indonesia, Korea, Malaysia, the Philippines, and Thailand domestic custodians send the foreign exchange confirmation to global custodians to secure cash settlements at the central bank current accounts for DVP transactions.

5.3.3 Market Access

In China, only QFIIs are allowed access to the market.⁸ In Korea, foreign investors must obtain an investment registration certificate (IRC). The IRC contains a unique identification number, which codes the investor's nationality and other information. In Viet Nam, non-resident investors must obtain a securities trading code. This code is used to monitor foreign ownership limits in the market by the Viet Nam Securities Depository (VSD). However, these issues do not have a direct impact on bond transaction flows in each country.

5.3.4 Messaging Standard

Messages between global custodians and domestic custodians are already standardized using ISO 15022 (or SWIFT message), except in a few countries. Also, messages between global brokers and domestic brokers are already standardized using Financial Information Exchange (FIX) protocol, which are expected to migrate to ISO 20022 in due course. Therefore, messages used for cross-border transactions are expected to be harmonized using ISO 20022.

5.3.5 Manual Pre-Settlement Matching

In Indonesia, Malaysia, the Philippines, Singapore, and Thailand, domestic custodians conduct pre-settlement matching with counterparties manually, using telephones and/or facsimiles. The main purpose of pre-settlement matching is to inform global custodians of the status of the pre-settlement matching during the previous settlement day (SD-1).

Matching used by local bond infrastructures for settlement matching will be discussed in Chapter 6.

⁸ China may open its OTC market (inter-bank bond market) since the People's Bank of China (PBOC) has published a notice in August 2010 on relevant issues in relation to renminbi investments by three types of institutions in the inter-bank bond market in the PRC on a pilot basis.

5.3.6 Securities Numbering

Global and local custodians use the international securities identification number (ISIN) as the standard securities numbering for cross-border bond transactions. ISIN in each market is discussed in Section 8.2.

5.3.7 Settlement Cycle

Settlement cycle for cross-border bond transactions vary from market player to another. Settlement cycles in each market are discussed in Chapter 7.

6. Matching

6.1 Matching Categorization

6.1.1 Trade Matching and Settlement Matching

There are several matching types such as trade matching and settlement matching.

The following diagram illustrates the trade matching and settlement matching processes.

Figure 6.1 Trade Matching and Settlement Matching Processes

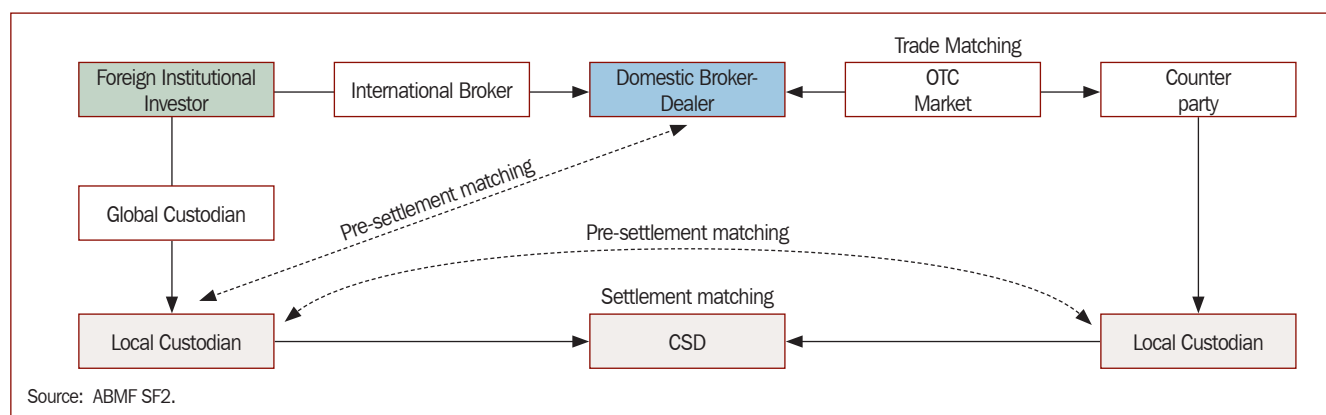

Definition and interpretation of the various processes differ from person to person or from one organization to another. Below are the definitions adopted in this report.

1. Trade matching and post-trade matching.

Details of the trade are compared between counterparties, mainly between local brokers, to ensure that there is no misunderstanding of the terms of the trade. This should be performed as soon as after the trade is executed, and in any event before the end of the business day. With automated trading systems (e.g., exchange systems or electronic OTC systems) matching is done at the time of trade, so there is no need for subsequent trade matching. However, many bond trades are still done through telephone or facsimile.

2. Settlement matching and Pre-settlement matching

Settlement matching is done when bond settlement transactions are entered from both seller and buyer (local custodians) into the CSD to settle the bond transaction.

- In some countries, pre-settlement matching is carried out before settlement matching. Details of the agreed trade are compared between the counterparties' settlement agents (e.g., local custodian and local broker) to ensure that all information needed for settlement is in place. Generally, pre-settlement matching does not bind counterparties as is done in matching. Pre-settlement matching is done for local custodian to send pre-settlement matching status to global custodian prior to the day when settlement matching is performed.

6.1.2 Central Matching and Local Matching

The process of matching, particularly settlement matching, is categorized into two types: central matching and local matching.

1. Central matching

Both of market participants (seller and buyer) or trading systems send the trade data to the CSD. Then, the CSD matches the data and sends back the matching confirmation to the seller and buyer.

2. Local matching

One side of the bond settlement, either a seller or a buyer, inputs the trade data to the CSD, and the CSD forwards the data to the counterparty (the other seller or buyer). The counterparty checks the data and send back affirmation to the CSD, if the data is deemed as acceptable.

6.2 Matching in Each Market in ASEAN+3

This sub-section discusses trade matching, pre-settlement matching, and settlement matching, as well as central or local matching, for government bond transactions. The trade system with trade-matching function is available in the market, and there is no need for pre-settlement matching since same-day affirmation can be done through the trade system. Results can be reported to global custodians as well as the authorities, which request reporting from the market participants.

The matching types for government bond transactions in each market in ASEAN+3 are listed in Table 6.1 below.

Table 6.1 Matching Types in ASEAN+3 Markets

	Trade Matching	Pre-Settlement Matching	Settlement Matching
PRC	CFETS	–	Central/Local
HKG		CMU	Central/Local
INO	–	Telephone, facsimile, etc.	Central
JPN	PSMS	PSMS	Local
KOR	B-TRIS	–	Central/Local
MAL	(BMS ETP)	RENTAS	Local
PHI	FI trading system/RoSS	Telephone, facsimile, etc.	Central/Local
SIN	–	PTI, Telephone, etc.	Local
THA	–	Telephone, facsimile, etc.	Central
VIE	HNX		Central

B-TRIS = Bond-Trade Report and Information Service; BMS ETP = Bursa Malaysia Securities Electronic Trading Platform; CFETS = China Foreign Exchange Trade System; CMU = Central Moneymarkets Unit; HNX = Hanoi Stock Exchange; PSMS = Pre-Settlement Matching System; PTI = Post-Trade Integration; RENTAS = Real-time Electronic Transfer of Funds and Securities
 – = no information.
 Source: ABMF SF2.

Trade matching or post-trade matching by trade system is available for government bond OTC markets in People’s Republic of China (PRC); Hong Kong, China; Republic of Korea; Malaysia; the Philippines; and Viet Nam. Pre-settlement matching is provided manually using telephone and facsimile in Indonesia, the Philippines, Singapore, and Thailand. In Japan, pre-settlement matching is done automatically through the pre-settlement matching system (PSMS). With respect to pre-settlement matching, local custodians confirm the quality of trade data by conducting pre-settlement matching with counterparty domestic brokers on the previous day of the settlement, and reports the matching status to global custodians to secure smooth settlement on settlement day. The pre-settlement matching process may better be provided automatically by trade system as post-trade matching facility or by the CSD as part of a post-dated transaction. If the CSD provides a post-dated entry, local custodians can input the trade data with the post-dated transaction and utilize the settlement-matching function for pre-settlement purposes.

Settlement matching for government bond markets in Indonesia, Thailand, and Viet Nam fall under central matching. On the other hand, settlement-matching processes for the bond markets in Japan, Malaysia, and Singapore adopt local matching. Settlement matching in People’s Republic of China (PRC); Hong Kong, China; Republic of Korea; and the Philippines can be both through central and local matching.

7. Settlement Cycles and Operating Hours

7.1 Settlement Cycles in ASEAN+3

The settlement cycles of government bond transactions vary from T+1 to T+30 in ASEAN+3. Settlement cycles are not stipulated by regulations or law, but are mainly determined by negotiation based on proprietary business practices of market participants and restrictions of payment infrastructures, etc.

Table 7.1 illustrates typical settlement cycles of domestic and cross-border transactions in ASEAN+3.

Table 7.1 Settlement Cycles in ASEAN+3
(based on each market practice and definitions)

	Domestic	Cross-Border
PRC	T+0/T+1	T+1
HKG	T+0/T+1/T+2 (negotiable)	T+0/T+1/T+2 (negotiable)
INO	T+2	T+2 (negotiable)
JPN	T+3, T+2 (from April 2012)	T+2 - T+4
KOR	T+1 T+1 - T+30 (negotiable)	T+1 - T+3 with T+1 for Government Bond traded on KRX stock market division
MAL	T+1/T+2	T+2 (negotiable) for unlisted and T+3 for listed bonds
PHI	T+1 ¹	T+1, T+3 (most prevailing)
SIN	T+1 but commonly contracted at T+3	T+1 to T+3 (negotiable) for unlisted and T+3 for listed bonds
THA	T+2	T+2 (negotiable)
VIE	T+1 - T+3	T+1 to T+3 (Hanoi STC) and T+1 for HCMC STC

¹ Market convention for domestic bond transactions is T+1, parties can still agree on T+0 basis.

Source: ABMF SF2.

The settlement cycles of domestic bond transactions in PRC, Republic of Korea, and the Philippines are T+1, which is shorter than that of other markets. In these markets, the trading system is directly linked with the CSD, and transmitting trade data to the CSD uses an online network. This STP may contribute to shorten the settlement cycles in the markets.

Although the cycle in Viet Nam is generally regarded as T+1, the definition of T in Viet Nam is not trade date but the date when trade data is entered to the trade system of the Hanoi Stock Exchange (HNX). Before entering the trade data into the system, an actual trade agreement should be made between a seller and buyer in the OTC market. The settlement cycle based on the trade date generally accepted in ASEAN+3 is T+2 or T+3 in Viet Nam.

7.2 Settlement Cycle as a Market Rule

In general, the settlement cycle is a common rule in the market. The rule may not be stipulated in regulation or law but should be observed by market participants. For example, if the settlement cycle of government bond trades in a market is T+3, investors must settle their government bond transactions in 3 business days. This means that when you buy government bonds, the broker must receive your payment no later than 3 business days after the trade is executed. When you sell a government bond, you must deliver to your broker your bond no later than 3 days after the sale.⁹

As such, the settlement cycle of the market means that majority of market participants need to follow the practice as a rule. Having said that, there is no such a rule in ASEAN+3, or even in each market, except for some markets. It will be beneficial for all market participants to have a common settlement cycle in ASEAN+3.

Some markets are trying to shorten their settlement cycles. The purpose of shortening the settlement cycles of government bonds is mainly the reduction of settlement risks, and the stabilization and activation of short-term financial markets. Unsettled bonds are exposed to settlement risks, and if a settlement cycle is longer, more unsettled positions are accumulated. The purposes of shortening the settlement cycles are listed below.

- 1) Reduction of settlement risks
 - Eliminating the risks of not receiving securities or cash on schedule
 - Reduction of the size and cost of fund raising associated with a counterparty's default
 - Mitigating replacement risks
 - Preventing the degree of chain of settlement failures

- 2) Stabilization and activation of short-term financial markets
 - Opportunities for raising funds and managing liquidity.
 - Mitigating market malfunctioning by speeding up the replacement of unsettled positions and the resolution of settlement failures
 - Improving liquidity of government bonds to make these more attractive as financial products.

⁹ US Securities and Exchange Commission, modified by the author.

To shorten the settlement cycle in a market, STP facilities of related infrastructures, such as online connection between trade systems and CSDs, need to be implemented. At the same time, all market participants need to follow the rule by automating individual internal systems.

Considering the settlement cycle in ASEAN+3, there is no institutional framework to discuss such an issue among stakeholders in the region yet. Thus, it is imperative that an institutional framework be established to have common rules and processes on settlement cycle in the region.

7.3 Operating Hours

Having a common settlement cycle in ASEAN+3 will be related to operating hours in each market, particularly the cut-off time in the market. Operating hours and cut-off time for DVP transactions in each market from system infrastructure's point of view is shown in Table 7.2.¹⁰

Table 7.2 Operating Hours in ASEAN+3

	CSD	Operating Hour (ASEAN time)	
		Open	Cut off time
PRC	CCDC CSDCC	– –	– –
HKG	CMU	8:30 (7:30)	18:30 (17:30)
INO	BI	6:30 (6:30)	19:00 (19:00)
JPN	BOJ JASDEC	9:00 (7:00) 9:00 (7:00)	16:30 (14:30) 17:00 (15:00)
KOR	KSD	9:00 (7:00)	17:00 (15:00)
MAL	MyClear	–	–
PHI	BTr-RoSS PDTC	9:30 (8:30) 8:00 (7:00)	15:30 (14:30) 18:00 (17:00)
SIN	MAS	–	–
THA	TSD	–	–
VIE	VSD	–	–

– = no information.
Source: ABMF SF2.

ASEAN Time refers to Jakarta time where the ASEAN secretariat is located, and is used for reference purposes only.

8. Standards on Numbering and Coding

8.1 General

It is important to standardize numbering and coding to promote STP of bond settlement. Numbering and codes related to bond transaction flows are: (1) financial instrument identification, (2) party identification, (3) safekeeping account, and (4) language and character code set. The language and character code set are discussed as follows.

¹⁰ In some cases, cut off time from market rule may be earlier.

Figure 8.1 Standard of Numbering and Coding

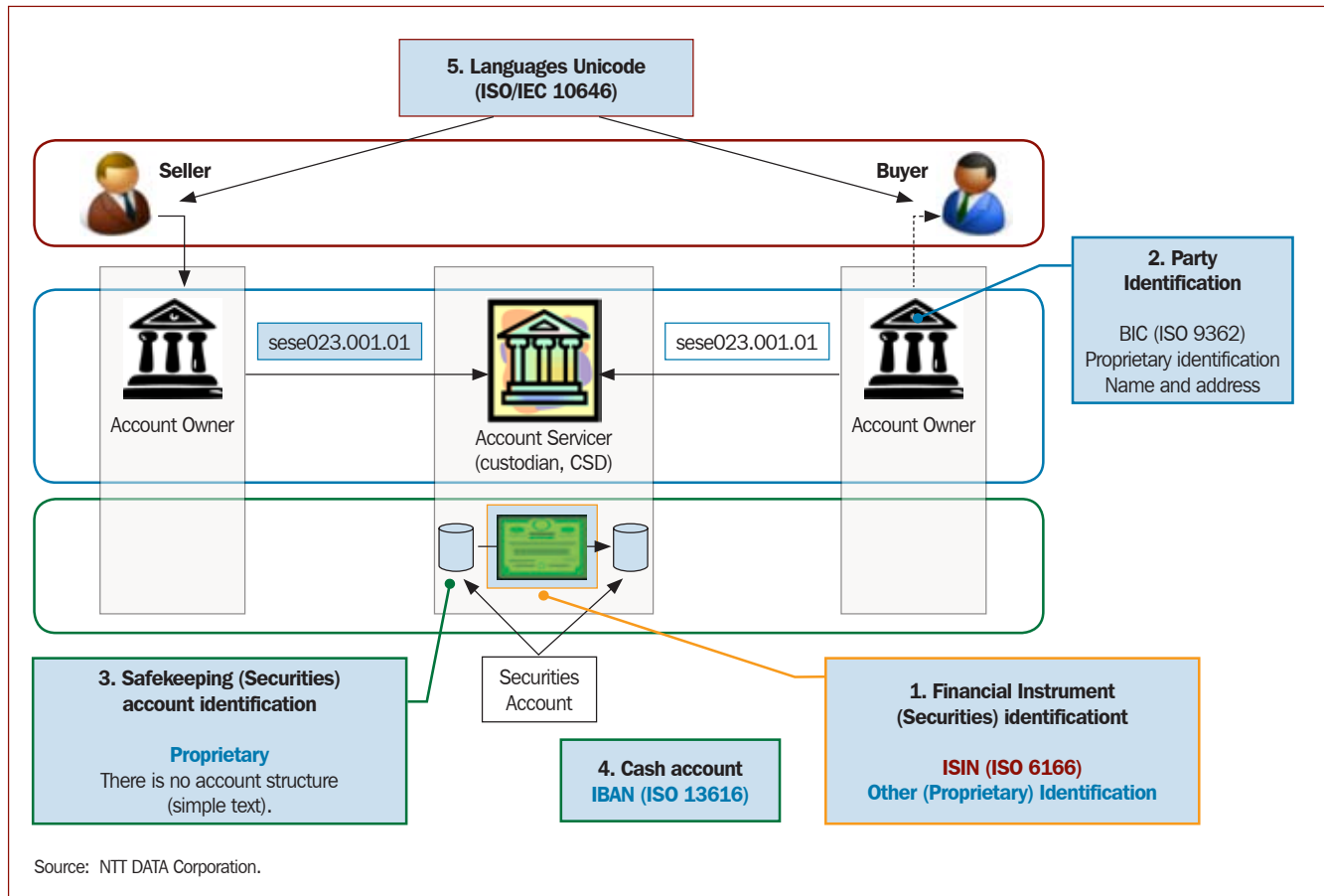

The following table illustrates the numbers and codes adopted in each market in ASEAN+3.

Table 8.1 Numbers and Codes in ASEAN+3 Markets

	Market	Securities Numbering	Financial Institution Identification	Securities Account	Cash Account	Encoding Scheme and Language
PRC	OTC	Proprietary code	Proprietary code	Proprietary code	Proprietary code	UNICODE (UTF 8)
HKG	OTC	ISIN and proprietary code (CMU issue)	Proprietary code	Proprietary code	Proprietary code	Code supported by SWIFT
INO	OTC	ISIN and proprietary code	BIC and proprietary code	Proprietary code	Proprietary code	–
JPN	OTC	Proprietary code	BIC and proprietary code	Proprietary code	Proprietary code	UNICODE (UTF 8)
KOR	OTC	ISIN and proprietary code	Proprietary code (account number)		Proprietary code	• KSC5601 for Korean
MAL	OTC	–	–	–	–	–
PHI	OTC	ISIN and proprietary code for Government Securities	Proprietary code (PDS-assigned firm)	Proprietary code	Proprietary code	UNICODE (UTF 8)
SIN	OTC	–	–	–	–	UNICODE (UTF 8)
THA	OTC	ISIN	BIC	Proprietary code	Proprietary code	UNICODE (UTF 8)
VIE	OTC	ISIN and proprietary code	N/A	Proprietary code	N/A	UNICODE (UTF 8)

BIC = Business Identifier Code; ISIN = International Securities Identification Number; OTC = over-the-counter
 – = No information.
 Source: ABMF SF2.

8.2 Securities Numbering

8.2.1 International Securities Identification Number (ISIN)

One of the most important numbering of bond settlements is the International Securities Identification Number (ISIN). ISIN is adopted by all economies, except China. In reality, however, proprietary securities numbering is used instead of ISIN in most ASEAN+3 economies.

ISIN, as defined in ISO 6166, uniquely identifies securities including bonds. ISIN is a 12-character alphanumeric numbering that does not contain information characterizing financial instruments, but serves for uniform identification of securities at trading and settlement. Figure 8.2 illustrates the ISIN code structure of Japanese government bonds. Conversion is also possible between proprietary numbering and ISIN.

Figure 8.2 ISIN Code Structure of Government Bonds (example)

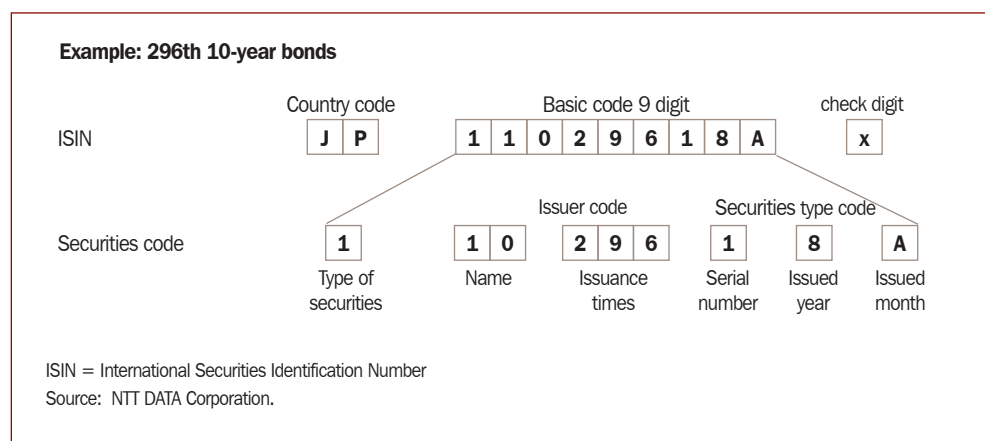

8.2.2 Association of National Numbering Agencies

Table 8.2 ANNA Members in ASEAN+3

	Full Member
PRC	China Securities Regulatory Commission
HKG	Hong Kong Exchanges and Clearing Ltd.
INO	PT Kustodian Sentral Efek Indonesia (Indonesian Central Securities Depository)
JPN	Tokyo Stock Exchange
KOR	Korea Exchange (KRX)
MAL	Bursa Malaysia
PHI	Philippine Stock Exchange, Inc.
SIN	Singapore Exchange Limited
THA	Thailand Securities Depository
VIE	Vietnam Securities Depository

Source: ABMF SF2.

All ASEAN+3 economies that have bond markets are full members of the Association of National Numbering Agencies (ANNA). ANNA and national numbering agencies (NNAs) allocate ISIN in accordance with ISO 6166. However, actual securities numbers are based on domestic proprietary numbering in many markets for the time being. It will be important to promote ISIN in ASEAN+3.

8.3 Party Identification and Account

The Business Identifier Code (BIC) is a unique identification code for both financial and non-financial institutions. Its structure is defined in ISO 9362. BIC is an 8- or 11-digit code, which indicates the financial institution with the last 3 digits as an option for branch code. It is used to identify each financial institution including branch. Figure 8.3 illustrates the code structure of ISO 9362.

Figure 8.3 Code Structure of ISO 9362

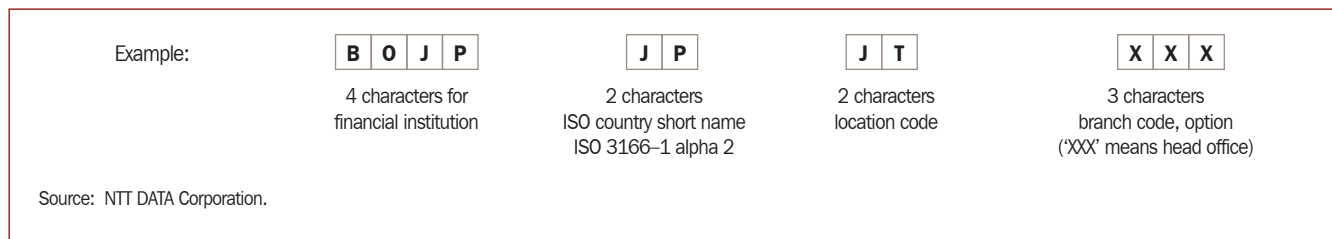

Some ASEAN+3 economies, such as Indonesia, Japan, and Thailand, have adopted the BIC for financial-institution identification, and Indonesia and Japan also use proprietary codes. Other economies continue to use proprietary coding only. It will be important to promote BIC as an identifier of banks and financial institutions including broker-dealers and custodians in harmonizing numbering and coding in ASEAN+3.

8.4 Safekeeping (Securities) Account Identification

All markets in ASEAN+3 use proprietary numbering for safekeeping accounts. There is currently no code structure for securities numbering as defined in ISO 20022. Safekeeping account identification is defined as text format with a maximum of 35 texts. Figure 8.4 is an example of a securities account. Because code structures of securities accounts are influenced by the taxation structure of each country, it will be a great challenge to standardize safekeeping account structure and numbering in the region; thus, there is also a need to harmonize the tax structure for non-residents before account structures can be standardized. When discussing standardization of safekeeping account, standardization of cash account is also taken into consideration.

Figure 8.4 Safekeeping Account (example)

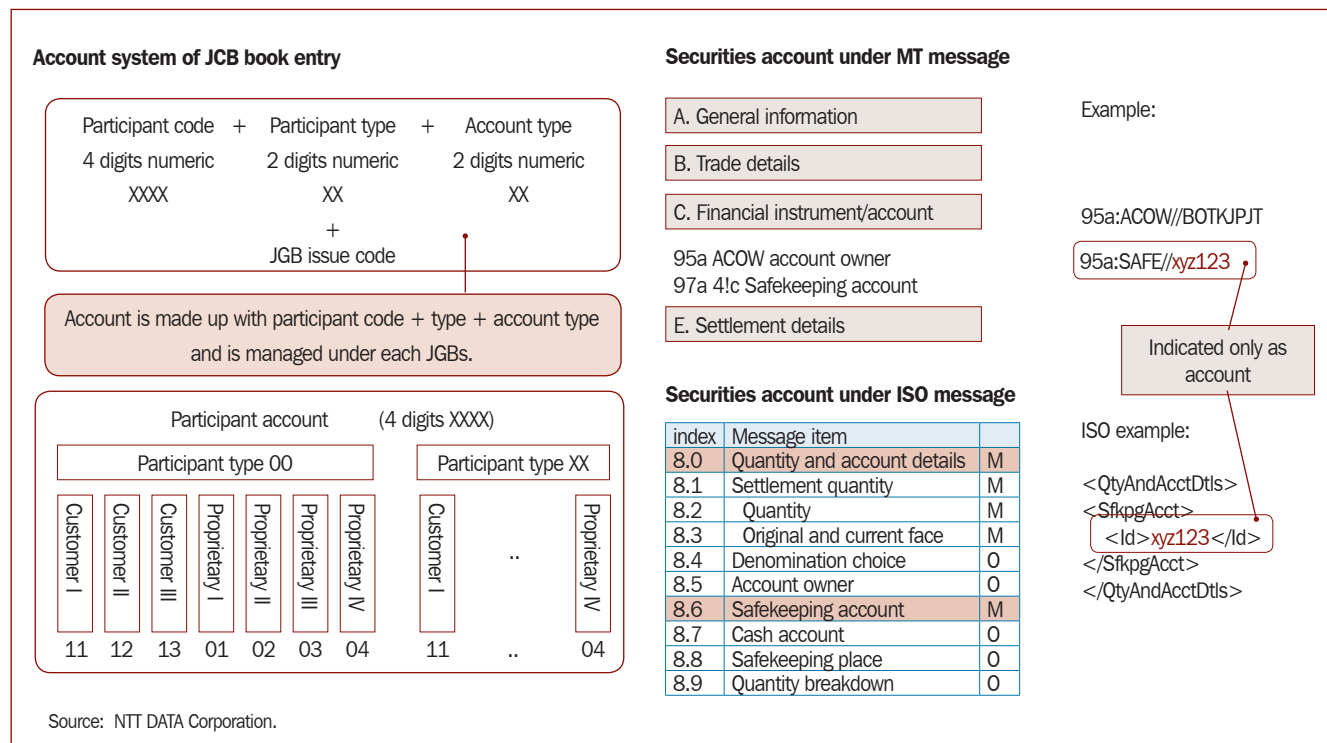

8.5 Character Code and Language

All CSDs in ASEAN+3 with bond markets accept UTF-8. In general, all CSDs use their own languages for day-to-day businesses except, in Hong Kong, the Philippines, and Singapore. Therefore, a standard language for bond settlement systems is a challenge in the region. Figure 8.5 shows an example of character code and language.

Figure 8.5 Sample Character Code and Language in ASEAN+3

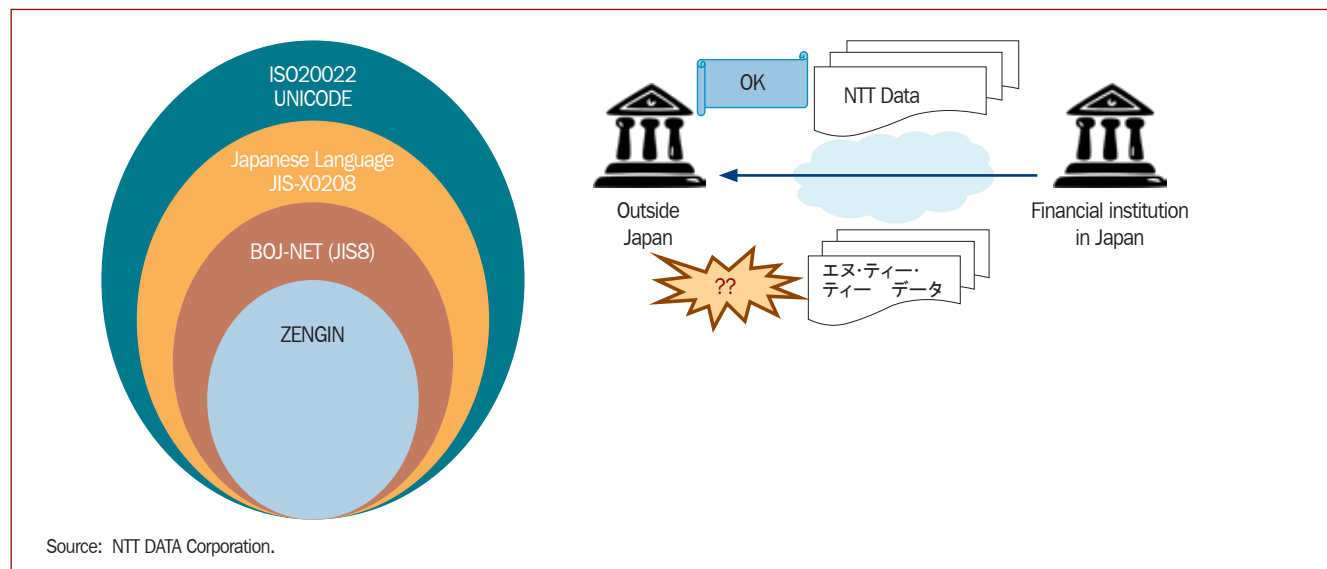

9. Possible Next Steps

9.1 Overview of Possible Next Steps for the ASEAN+3 Bond Market Forum SF2

The following next steps are the proposed for the ASEAN+3 Bond Market Forum (ABMF) Sub-Forum (SF2).

- 1) Continue the survey of bond transaction flows, messaging and market practices
- 2) Continue ISO 20022 fit-and-gap analysis for government bonds DVP transaction
- 3) Propose a roadmap to standardize and harmonize bond markets in ASEAN+3

ABMF SF2 envisions that the possible steps listed above will accomplish its purposes. The forum sees it fit to continue the identification of transaction flows, messaging and market practices by expanding its scope from government bonds DVP transactions. The scope of the survey will be expanded to issuance, interest payment, and redemption of government bonds. Possible cross-border DVP transaction flow will also be included in the survey. Some basic trades of corporate bonds including some corporate practices will be surveyed, as well. In addition, SF2 will collect information on Legal Entity Identifier (LEI)¹¹ and improvements in trade data collection in ASEAN+3. Fundamental surveys of government bond transactions, including fit-and-gap analysis of message items of settlement instruction and confirmation of government bonds DVP transaction, will continue to be conducted to find possible solutions for cross-border STP of bond transactions. A discussion on the roadmap to implement STP in ASEAN+3 can be found in the succeeding subsection.

9.2 Scope of Fit-and-Gap Analysis

Bond transaction messages between global custodians and local custodians are already standardized since SWIFT messages are used. Bond trades and transactions between brokers and custodians who are doing businesses globally and internationally are already based on international standards, as well. Also, adopting international standards for messages among global players is under the discretion of each player. Therefore, standardization of messages among international players is not the focus of ABMF SF2. However, if messages of domestic bond settlement infrastructures such as CSD remain proprietary, local custodians need to convert external messages to proprietary one to fit local standards, which increases the cost of transaction processing in the region. Therefore, standardization of domestic flows will significantly contribute to enhance interoperability and STP of cross-border transactions in the region.

¹¹ A Legal Entity Identifier (LEI) is a unique ID associated with a single corporate entity. Although no common entity ID convention exists in the market today, a range of regulatory initiatives are driving the creation of universal LEI standard for financial markets.

Figure 9.1 Conversion at Local Custodian

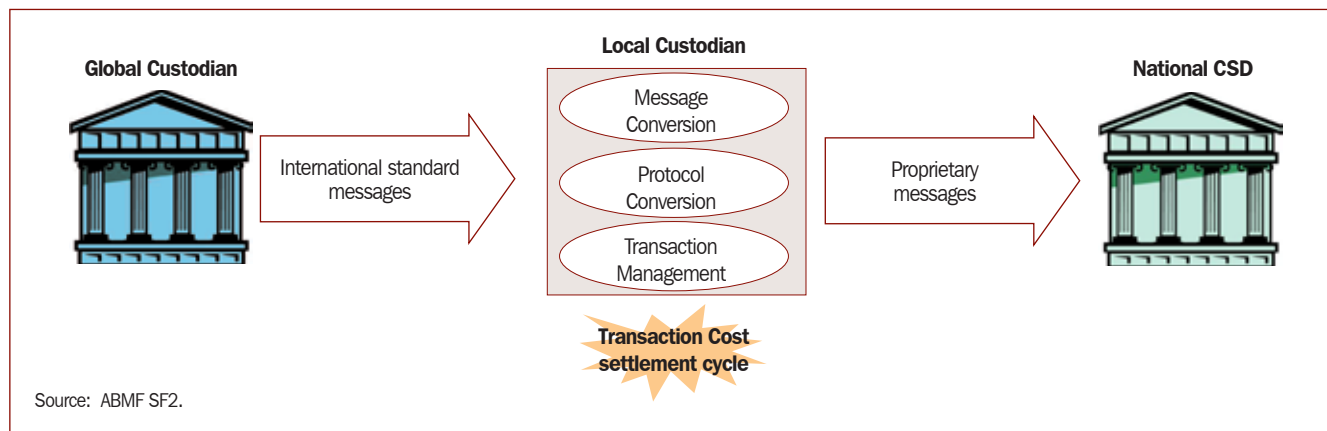

In other words, if the messages of domestic infrastructures become compatible with the international standard, opportunities for regional interoperability will be enhanced. An image of the scope is illustrated in Figure 9.2. More specifically, the adoption of ISO 2022 frameworks will help reduce the cost of local custodians by streamlining the processes to convert messages from international standards to local practices among local custodians. This is illustrated in Figure 9.3.

Figure 9.2 Scope of Standardization

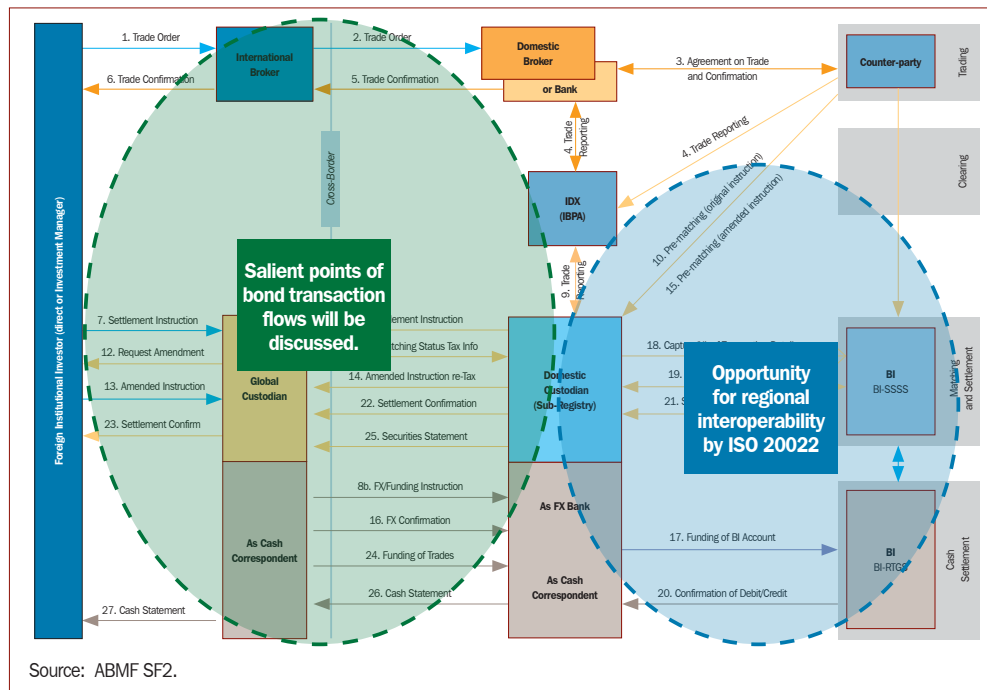
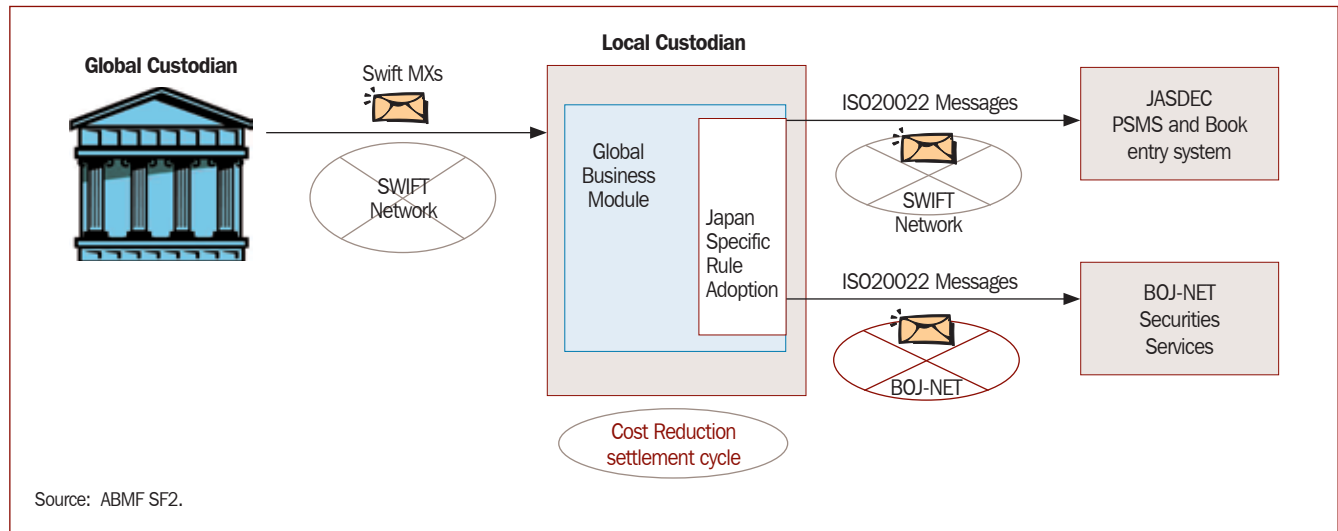

Figure 9.3 No Conversion



Therefore, a fit-and-gap analysis of ISO standards and local practices of domestic bond transaction will be carried out.

To examine conformity with ISO20022, business processes such as message transactions themselves and message flows need to be surveyed. In some cases, MT (ISO 15022) to MX (ISO 20022) reverse engineering may be required. ISO 20022 includes the processes from trading to bond and cash settlement. Considering the survey on DVP transactions conducted by SF2, a fit-and-gap analysis of ISO 20022 related to bond settlement (MT5xx of ISO 15022) will focus on specific targets of messages for the next step.

Figure 9.4 Mapping ISO20022 with Conventional Local Standard

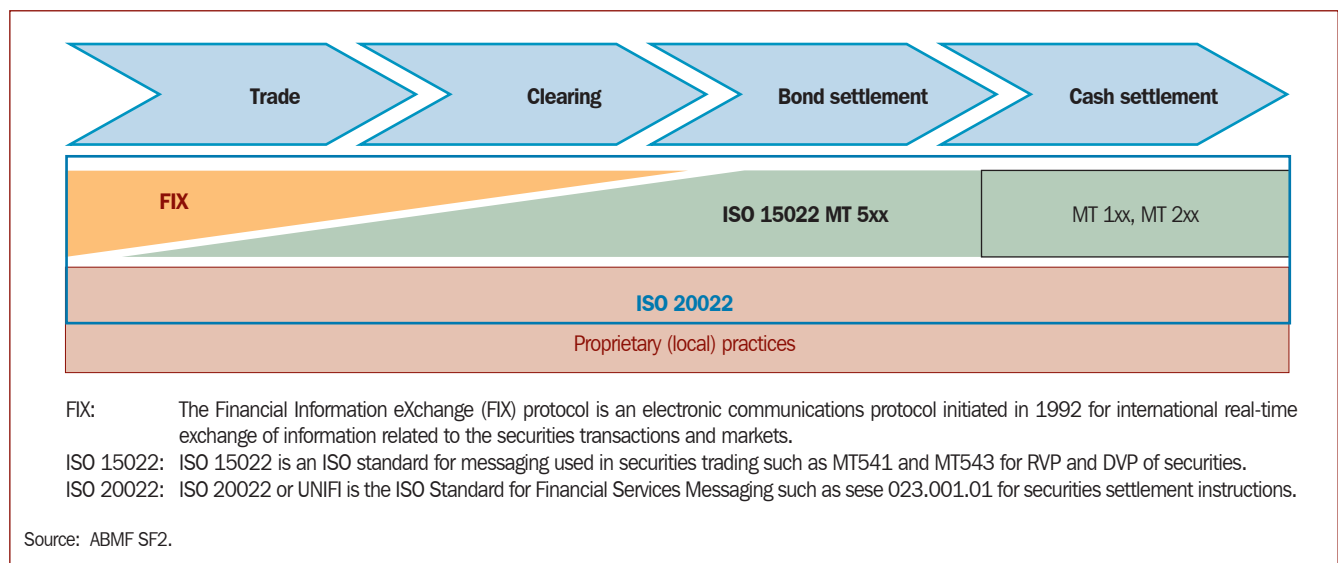

A fit-and-gap analysis of terminologies will also be conducted.

9.3 Drafting Roadmaps

Based on the survey results, STP and standardization of cross-border bond transactions in ASEAN+3 are possible points of discussion in subsequent initiatives of SF2. Some possible roadmaps and scenarios to make STP of cross-border bond transactions a reality in the region may be proposed.

Major events in the ASEAN+3 such as the ASEAN Economic Community (AEC), which could have an impact on bond trades and settlement flows, need to be identified and scheduled. Medium- to long-term plans of member countries and economies also need to be shared and organized. Possible future modes of payment infrastructures also have to be discussed with due consideration given to related events and medium- to long-term plans of member countries and economies. Institutional framework to implement such roadmaps will also be considered. Plausible legal and regulatory framework such as tax-related issues will also be discussed.

Trends in breakthroughs in information technology will also be considered in the proposed road map. All these may be put in a sheet and discussed among members and experts to share possible future images of bond trade and settlement market infrastructures. A draft image of a roadmap is illustrated here.

Figure 9.5 Roadmap (Master Plan) Image

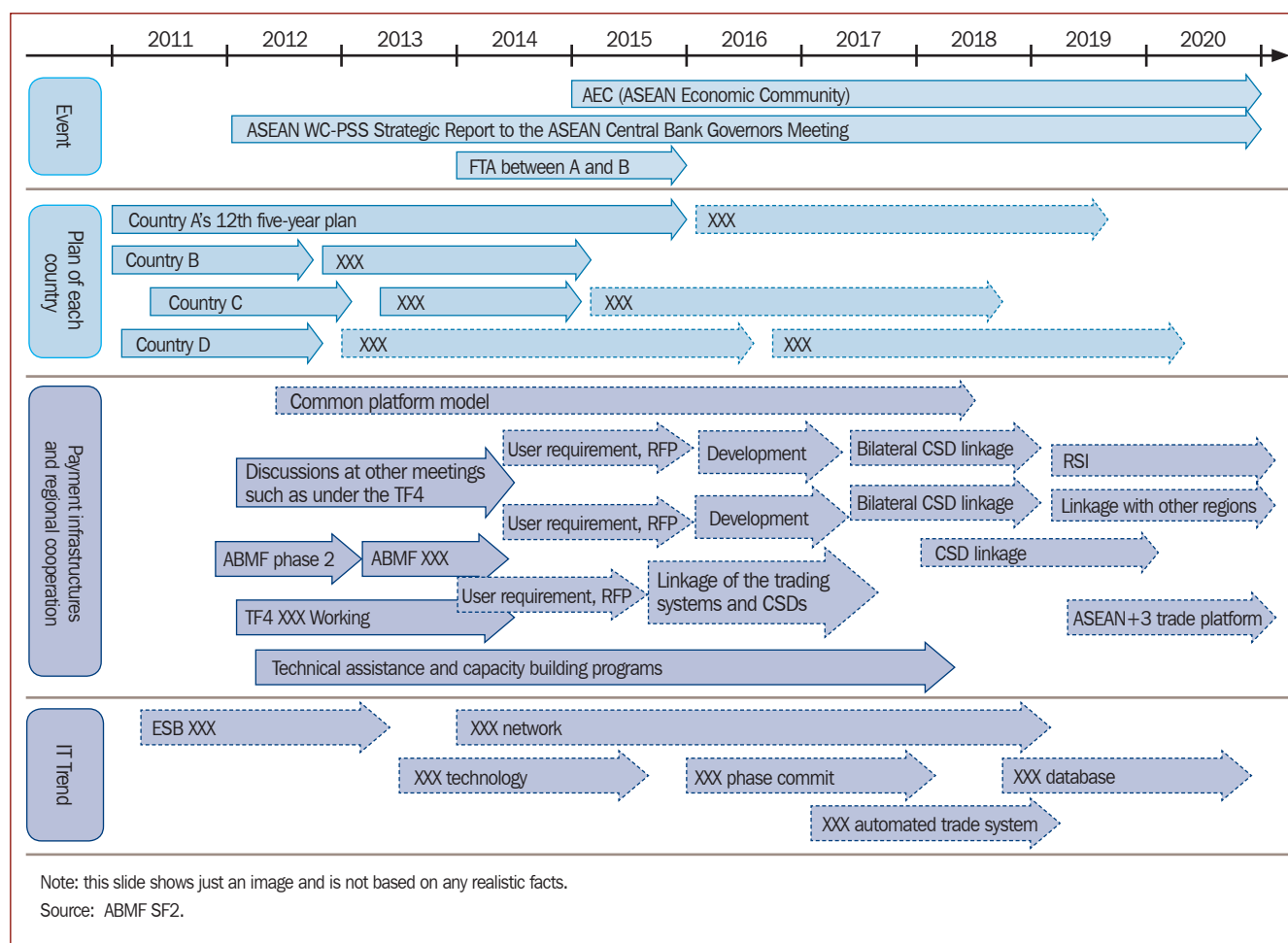

Some possible goals of the roadmap can include:

- 1) Establishing bilateral connections between countries with existing bond-market infrastructures, as a first step to develop STP of cross-border transactions; and
- 2) Other insights that may be generated from the survey results, as well as discussions of TF4 on regional settlement intermediaries.

Figure 9.6 Future Image of Regional Settlement Intermediaries

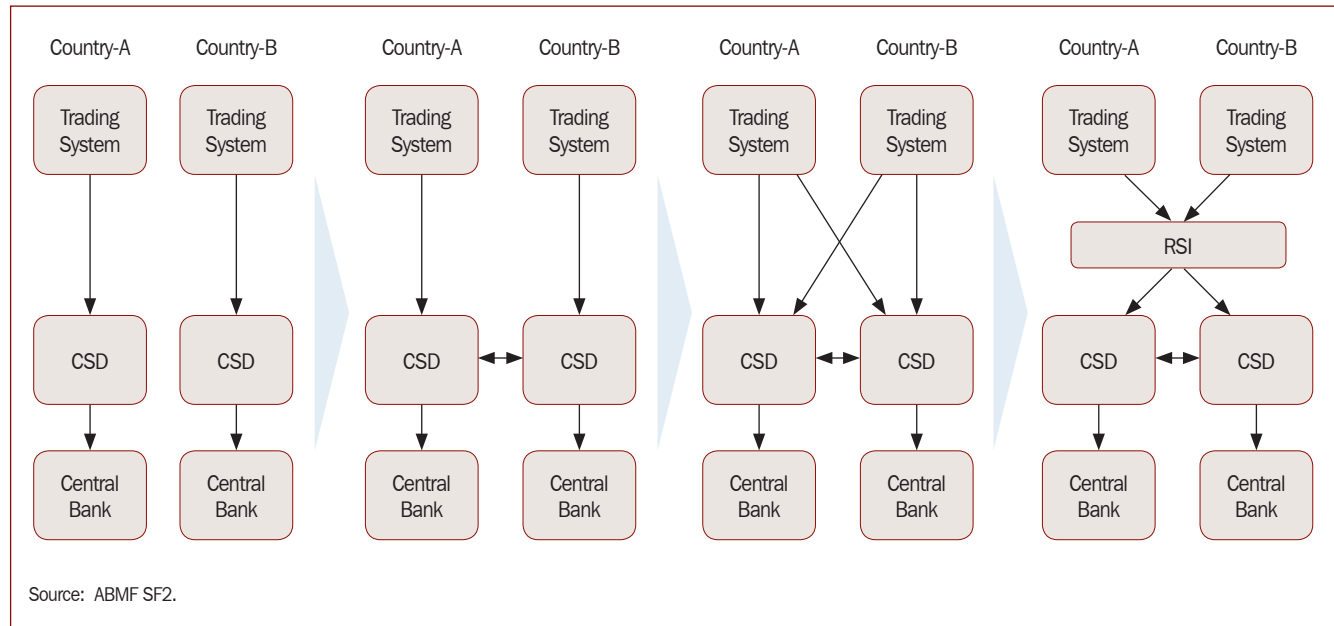

9.4 Detailed Government Bond Transaction Flow

Depending on future discussions and results of the fit-and-gap analysis, further details of government bond transaction flow may be considered for markets that have the possibility of establishing bilateral connections as a pilot study. The following is a proposed detailed flow for DVP transaction.

Figure 9.7 Example of Detailed Bond Transaction Flow

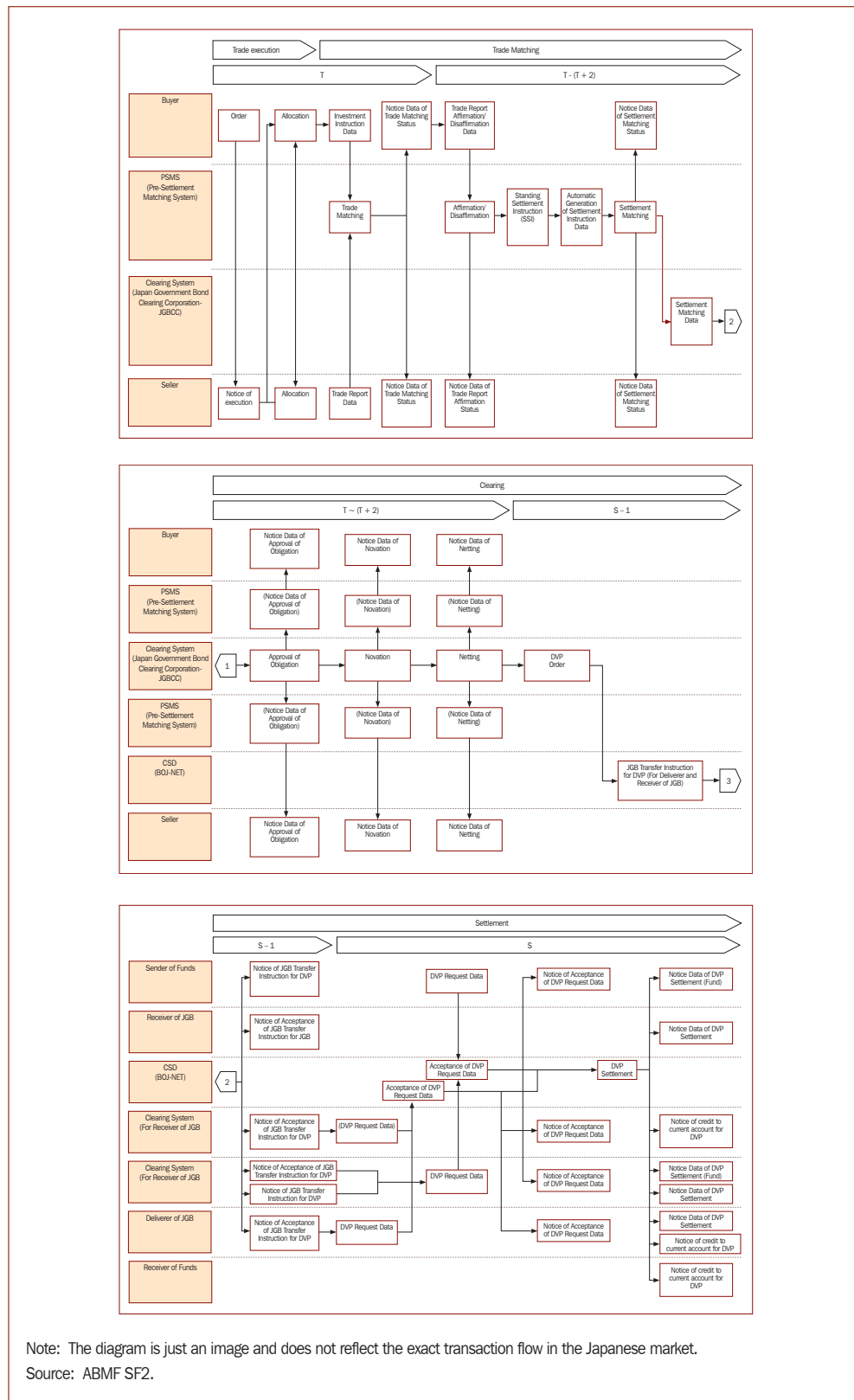

9.5 Technical Assistance

It is important for ASEAN+3 bond markets to achieve a level of equivalence if the region is to develop deep, liquid, efficient and effective bond markets to consolidate investments within the region, and have these investments revolve within the region. Therefore, it will be imperative to support countries, which are planning and developing bond market infrastructures that are interoperable with other bond market infrastructures in the region. From this viewpoint, mutual cooperation between the member countries and economies in the region, including technical assistance, will be one of the important issues of the ABMF SF2.

10. Conclusion

ABMF SF2 surveyed government bond trade and settlement procedures from the viewpoint of cross-border STP. As a result of the survey, SF2 clarified the typical business flows of domestic and cross-border government bond transactions, as well as trade, clearing, and settlement infrastructures. SF2 also shared information on the adoption of standards such as ISIN, BIC, securities account, language code, and communication protocols. According to survey results, ASEAN+3 economies have robust and sound bond infrastructures, and continue to improve their infrastructures with technical innovations. Through discussions during SF2 meetings, countries that do not have bond markets and corresponding infrastructures acknowledge the importance of the acceptance of common standards on bond market infrastructures. The survey demonstrated that infrastructures for cross-border bond transactions are undeveloped within the region at present.

SF2 concludes that the next phase of the sub-forum will discuss the interoperability of bond transactions through the standardization of trade and settlement systems, and cross-border DVP to mobilize regional savings for regional investments. Based on the survey of flowcharts of government bond transactions in each market, the next phase of SF2 will perform four major tasks:

- a) fit-and-gap analysis of flows and messaging;
- b) clarifying issuance, interest payment, and redemption procedures of government bonds;
- c) basic survey about corporate bonds, and
- d) a roadmap about the future of ASEAN+3 bond markets.

Through these activities, human interaction will be facilitated and these relationships will help the development of cross-border bond transactions.

Finally, this report is envisioned to shed light on facilitating the development of more efficient and more liquid ASEAN+3 bond markets.

11. Acknowledgement

This report is a result of many efforts of individuals and various organizations.

Below is the list of organizations that convened the different ABMF meetings in their respective countries:

The Ministry of Finance of Japan hosted the 1st ABMF. The Asian Development Bank hosted the 2nd ABMF. Persatuan Permasaran Kewangan Malaysia, CIMB Group, and Suruhanjaya Sekuriti Malaysia hosted the 3rd ABMF. Korea Capital Market Institute, Korea Financial Investment Association, and Korea Securities Depository hosted the 4th ABMF. The Ministry of Finance of the Republic of Indonesia, the Indonesia Stock Exchange, PT Kliring Penjaminan Efek Indonesia, and PT Kustodian Sentral Efek Indonesia hosted the 5th ABMF. The People's Bank of China, China Central Depository and Clearing hosted the 6th ABMF.

In compiling this report, references were made to a number of publications by global custodians, including J.P. Morgan, State Street, Citigroup, Dexia, and Standard Chartered.

Valuable information, advice, and guidance have been provided by national members, national experts, international experts, and members of ABMF-Japan in particular Takeshi Kurihara and his team from the Ministry of Finance of Japan.

We have also received much information from central banks who are not members of the ABMF SF2, including Mr. Ronald Waas and his team of the Bank Indonesia; all related departments of the Bank of Japan; Mr. Jeon Beop Yong and his team of the Bank of Korea; Mr. Mohd Fairuz Hj Ahmad and his colleagues of Bank Negara Malaysia; Bangko Sentral ng Pilipinas; Ms. Dan Meng Chen of Monetary Authority of Singapore; Dr. Chim and his team from the Bank of Thailand, and Mr. Nguyen Toan Thang and his team at the State Bank of Viet Nam.

SF2 has obtained valuable information from presenters at the information sessions as shown in Appendix 4.

During the visit in ASEAN+3 economies, the entities visited shown in Appendix 5 kindly provided very valuable information to SF2.

The National ABMF, the first of which was established in Japan (ABMF-J), was led by Kazushi Iwai. The National ABMF in Korea and the Philippines were also established and contributed greatly to ABMF activities.

Valuable information was also provided to SF2 by entities during the visit in ASEAN+3 economies (see Appendix 5 for list of entities).

The ADB secretariat support staff,¹² editor,¹³ and NTT DATA Group¹⁴ helped the SF2 ADB consultant in completing this report.

The ADB secretariat and consultants for SF2 would like to express their heartfelt gratitude to all of the above for their kind assistance.

¹² Raquel Borres, Sheila Sombillo, and Susan Monteagudo.

¹³ Zuraida Mae Villanueva

¹⁴ Takahiro Yanagisawa, Keiko Yoshida, Masahiro Nishihara, and Yosuke Yamada also assisted the ADB consultant of SF2.

Appendixes

Appendix 1

Questionnaire on Implementing Straight Through Processing

Draft prepared for the 2nd ASEAN+3 Bond Market Forum (ABMF) Sub-Forum 2 (SF2) on 14 December 2010, Manila

Introduction

- a) This questionnaire is prepared for a baseline survey on message standardization and transaction cost aiming at implementing straight through processing (STP) in cross-border bond transactions between the countries of the Association of Southeast Asian Nations, the People's Republic of China, Japan, and the Republic of Korea (ASEAN+3) region.
- b) This survey seeks to understand the bonds settlement infrastructures and business processes of government bond transactions in each country.
- c) The survey for the bonds settlement infrastructures is to share essential information to implement STP such as the level of automation and dematerialization of bonds, as well as players in each country, since manual operations and proprietary processes could be the reason for the higher cross-border transaction cost in the region.
- d) It is desirable for national members to answer the questionnaire for all central securities depositories (CSDs) of each country by collecting necessary information and compiling them with their best efforts. International experts are expected to answer the questions from the viewpoint of cross-border transactions.
- e) Outcome of this baseline survey may provide global market players, such as custodians, with useful information for cross-border transactions to be processed more efficiently. The outcome may also provide the Asian Bond Market Initiative Taskforce 4 (ABMI TF4) with useful information for the further study to implement an infrastructure for cross-border transactions such as CSD linkage (i.e, regional settlement intermediary [RSI]).
- f) If a new CSD system is already under development, the answer to the questionnaire is expected to be based on the requirements and the specifications of the new system as much as possible. Inclusion of development schedule is desirable.

- g) When publishing the report of ABMF SF2, the report will be checked by all members beforehand. Therefore, any information and data, which are helpful for this survey, are appreciated.
- h) It is desirable to update the “Market Comparison Matrices (for Bond), GoE Sub committee B, As of Feb. 9, 2009”.

1. Bond market infrastructures

Describe the entities involved in bond trading, matching, clearing, and settlement together with the interrelationship between the bond settlement infrastructures.

1.1 Draw a diagram showing relationship between bond settlement infrastructures (e.g., CSD, central counterparty [CCP]) in each country.

1.2 Please clarify and explain the diagram.

1.3 Bond markets in each country or economy

1.3.1 Name of the bond markets

1.3.2 Owner and operator of the bond markets

1.3.3 Name of networks (e.g., SWIFT) and communication protocols (e.g., Transmission Control Protocol/Internet Protocol [TCP/IP]) of the networks connected to the bond markets

1.4 Matching systems in each country or economy.

1.4.1 Name of the matching systems

1.4.2 Owner and operator of the matching systems

1.4.3 Name of networks (e.g., SWIFT) and communication protocols (e.g., TCP/IP) of the networks connected to the matching systems

1.5 Clearing systems (CCPs) in each country or economy.

1.5.1 Name of the clearing systems

1.5.2 Owner and operator of the clearing systems

1.5.3 Name of networks (e.g., SWIFT) and communication protocols (e.g., TCP/IP) of the networks connected to the clearing systems

1.6 Cash settlement systems (such as real-time gross settlement [RTGS] systems) in each country/economy.

1.6.1 Name of the cash settlement systems

1.6.2 Owner and operator of the cash settlement systems

1.6.3 Name of networks (e.g., SWIFT) and communication protocols (e.g., TCP/IP) of the networks connected to the cash settlement systems

1.6.4 Delivery versus payment (DVP) and Bank for International Settlements (BIS) model for each type of bond, if DVP is available.

BIS model

Model 1 - Systems that settle transfer instructions for both bond and funds on a trade-by-trade (gross) basis, with final (unconditional) transfer of bond from the seller to the buyer (delivery) occurring at the same time as final transfer of funds from the buyer to the seller (payment).

Model 2 - Systems that settle bond transfer instructions on a gross basis, with final transfer of bond from the seller to the buyer (delivery) occurring throughout the processing cycle, but settle funds transfer on a net basis, with final transfer of funds from the buyer to the seller (payment) occurring at the end of the processing cycle.

Model 3 - Systems that settle transfer instructions for both bond and funds on a net basis, with final transfers of both bond and funds occurring at the end of the processing cycle.

- 1.6.5 Please explain functions related to liquidity such as liquidity saving features and intraday overdraft.
- 2 Survey on CSDs in each country
If there are more than one CSD, could you answer the following questions for each CSD separately, please?
- 2.1 The name of the CSD.
 - 2.2 The owner and operator of the CSD.
 - 2.3 Types of Bond (e.g., government bond, investment fund, short-term bond, and corporate bond) supported by the CSD and the status of dematerialization of each type of bond.
 - 2.4 The number of stakeholders for each category such as domestic banks, foreign banks, securities companies, etc. participating in the CSD.
 - 2.5 List of all business transactions with brief explanation related to bond trade and settlement in each CSD.
 - 2.6 The following items related to the networks used for each CSD.
 - 2.6.1 Name of the networks (e.g., SWIFT)
 - 2.6.2 Type of the line (e.g., leased line, Integrated Services Digital Network [ISDN], Internet, IP-Virtual Private Network [IP-VPN])
 - 2.6.3 Communication protocol (e.g., TCP/IP)
 - 2.6.4 Communication interface (e.g., MQ,¹⁵ Common Object Request Broker Architecture [CORBA])
 - 2.6.5 Message format (e.g., text, comma separated value [CSV], extensible markup language [XML])
 - 2.6.6 System configuration, network configuration, and center configuration including contingency measures
 - 2.7 Other CSDs and international central securities depositories (ICSDs) linked to the CSD. If there are different CSDs and/or ICSDs connected, please answer all of them with brief explanation.
- 3 Comparison of the typical business flowchart drawn based on the standard template.
- Harmonization of business processes of typical transactions is an essential matter to implement STP. Therefore, comparing typical business flowchart based on standard template is an important step to implement STP for cross-border bond transactions.
 - A step-by-step approach will be taken. Firstly, business processes for typical government bond transactions such as free of payment (FOP) and DVP will be surveyed. Then, other transactions such as issuance, interest payment, and redemption may be covered. Also, bonds other than government bonds such as corporate bonds may be covered after this initial survey.
- 3.1 Drawing business flowchart of FOP and DVP as typical business processes in each country based on the template is desirable.
 - 3.2 Drawing the business flowcharts of the typical processes for cross-border transactions based on the template is desirable. Cross-border transactions by nonresidents (inbound) and foreign bond transactions by residents (outbound) are expected to be covered by international experts. Please list all major (inbound and outbound) transaction types and choose the most typical transaction type among them with brief explanation.

¹⁵ Message queue interconnects applications exchanging data, which are stored in queues to make next processes start without waiting completion of previous processes at interconnected applications (asynchronous communication).

- 3.3 Conducting preliminary fit-and-gap analyses of the typical business processes (not message format) with the ISO 20022 is desirable. Fit-and-gap analysis of definition of terminologies is also desirable.
 - Regarding fit-and-gap analysis with ISO 20022, supplemental survey may be carried out during Phase 2 of SF2 considering the results of this survey.
 - Harmonization of terminologies also needs to be carried out following the international standard during Phase 2.
 - 3.4 If there are any other candidates as typical business processes to be analyzed, please list them up.
 - Regarding additional business processes (such as issuance, interest payment, and redemption) other than FOP and DVP, supplemental survey may be carried out during Phase 2, considering the results of this survey.
 - Transactions covering taxation of government bonds, such as interest payment for nonresidents, may be chosen as a candidate for the next step of survey after sharing the methodology through the initial survey.
- 4 Survey on matching
- Survey on matching for typical business processes
- 4.1 What kind of matching is introduced (automated) for the typical business processes (FOP and DVP) in each CSD? Please refer to the reference “Pre-Settlement Matching System (PSMS).”
 - 4.2 Please comment on the pros and cons of “one-sided (local)” and “two-sided (central),” or both for matching systems. What is the cost implication of the difference of matching?
 - One-sided trade input matching is a way of entering business transactions from one side of the trade counterparties (for example, from the seller side). The entered transaction is sent to the buyer. The buyer checks the transaction and enters “OK” sign if it is correct, or enters “NG” if it is not correct. Two-sided trade is a transaction wherein both seller and buyer of the trade enter the transaction from both sides.
- 5 Survey on settlement cycles
- Survey on the settlement cycles of typical business processes for both local and cross-border transactions
- 5.1 How long is the standard settlement cycle from trade in government bonds to settlement?
 - 5.2 In case there are differences between settlement cycles of typical business processes (FOP and DVP transactions), what are the reasons for that?
 - 5.3 The settlement cycles of cross-border transaction and local transaction are same?
 - 5.4 If there is difference between the settlement cycles of cross-border and local transactions, how long is the cycle of these transactions? And what are the reasons for the differences?
 - 5.5 If there is any initiative to shorten the settlement cycles, please describe it.
 - 5.6 If there are target settlement cycles to be shortened, please describe them including target date to start them.
 - 5.7 What are the background and reasons for the initiative concerning shortening the settlement cycle? What is cost implication of shortening of settlement cycle?

- 6 Survey on standards such as numbering and coding
 - a) Securities numbering: International Securities Identification Number (ISIN, ISO 6166)
 - ISIN defined in ISO 6166 uniquely identifies securities including bonds. The ISIN code is a 12-character alphanumeric code that does not contain information characterizing financial instruments but serves for uniform identification of securities at trading and settlement.
 - b) Financial institution identification: Business Identifier Code (BIC, ISO 9362)
 - ISO 9362 specifies the elements and structure of a universal identifier code, the BIC, for financial and non-financial institutions and related entities, for which such an international identifier is required to facilitate automated processing of telecommunication messages in banking and related financial transaction environments.
 - c) Securities account: ISO 20022
 - Safekeeping account of ISO 20022 is the securities account which the account servicer holds account for the account owner. Safekeeping account identification is defined as text format.
 - d) Cash account: International Bank Account Number (IBAN, ISO 13616)
 - ISO 13616 specifies the elements of IBAN used to facilitate the processing of data internationally in data interchange, in financial environments as well as within and between other industries.
 - e) Character code: Unicode Transform Format (UTF, ISO/IEC 10646)
 - ISO/IEC 10646 specifies the Universal multiple-octet coded Character Set (UCS), which is applicable to the representation, transmission, interchange, processing, storage, input and presentation of the written form of the languages of the world as well as additional symbols. Sometimes the character set is expressed as UTF, which is practically equivalent with the UCS.
- 6.1 Securities numbering
 - 6.1.1 Is the ISIN used for all securities numbering of bond transactions?
 - 6.1.2 What kind of coding schemes other than ISIN are used?
 - 6.1.3 If local securities numbering is mainly used, is it possible to make conversion between local numbering and ISIN? If possible, how are they converted? Are there any manual operations remaining? What is the cost implication of the manual operations?
- 6.2 Financial institution identification
 - 6.2.1 What kinds of coding schemes are used for financial institution identification codes? If more than one coding schemes are accepted, how are those codes handled?
 - 6.2.2 How do you convert between ISO 9362 (BIC) and local codes, if necessary?
 - 6.2.3 Are there any manual operations remaining? What is the cost implication of the manual operations?
- 6.3 Securities account
 - 6.3.1 Is the ISO 20022 used?
 - 6.3.2 If not, what kind of coding schemes are used?
 - 6.3.3 If yes, please specify "Account identification".
 - 6.3.4 Are there any manual operations remaining? What is the cost implication of the manual operations?
- 6.4 Cash account
 - 6.4.1 Is the IBAN code used?
 - 6.4.2 If not, what kind of code schemes are used?

- 6.4.3 If yes, please specify Basic Bank Account Number (BBAN).
- 6.4.4 Are there any manual operations remaining? What is the cost implication of the manual operations?
- 6.5 Character code and language
 - 6.5.1 Is the Unicode (UTF) used as a character set?
 - 6.5.2 If you use a character set other than Unicode, which standard character set do you use?
 - 6.5.3 Is it desirable to use English as a common language? Otherwise, is it desirable to have standard conversion scheme between local and ISO standards? Are there any manual operations remaining? What is the cost implication of the manual operations?
- 7 ISO and the local practices in each country
 - 7.1 If there are any local practices in each country, which are to be proposed to a part of ISO standard, please describe them with possible reasons.
 - 7.2 Please comment on how to make the differences between local and global standards narrower.
- 8 Transaction cost

Analysis about transaction fee for typical business processes (FOP and DVP)

 - 8.1 Fee per transaction
 - Who charges to whom for typical business processes?
 - 8.2 Fee for other cases including charging information and policy
 - 8.3 Detailed analysis of cost for the typical cross-border transactions is desirable.
- 9 Medium- to long-term strategy

Sharing strategy for STP of bond transactions is desirable.

 - 9.1 Are there any official initiatives to promote STP of bond trading in each country?
 - 9.2 From which area STP is promoted?
 - 9.3 What are the biggest challenges for members when it comes STP?
 - 9.4 Please describe ISO 20022-related initiatives on cross-border securities settlement, if any.
- 10 Any other information and/or comments to be shared by ABMF members

What are challenges and problems encountered?

If there are any questions and comments on this questionnaire, could you send e-mail or call ADB Consultant, please?

Taiji Inui: ADB Consultant for ABMF SF2 (NTT DATA Corporation)
E-mail: inuit@nttdata.co.jp

Thank you very much for your kind cooperation.

Acknowledgement

When drafting this questionnaire, the Chair and Vice-chairs of the ABMF SF2 have given much useful advice to the ADB consultant. National member, expert, and international expert, as well as ADB secretariat and fellow consultants, have made helpful comments and advice to the ADB consultant. The ADB consultant very much appreciates their kind support and assistance.

Appendix 2

Table of Survey Questionnaire Responses

Table A1.1 Bond Market Infrastructures in ASEAN+3

Country	1.3 Bond Market			1.4 Matching		
	1.3.1 Name of Bond Market	1.3.2 Owner and Operator of the Bond Market	1.3.3 Name of Network and Protocol	1.4.1 Name of Matching System	1.4.2 Owner and Operator of Matching System	1.4.3 Name of Network and Protocol
Brunei Darussalam	–	–	–	–	–	–
Cambodia	–	–	–	–	–	–
People's Republic of China	Inter-bank Market (OTC market)	No single owner of the market. Operated by CFETS	Proprietary network TCP/IP	Central Bond Integrated Services System	CCDC	Proprietary network TCP/IP
	Exchange Market	SSE, SZSE	–	NGTS, IEPFS, INTS	Exchange Market–CSDCC	–
Hong Kong, PRC	Unlisted bonds: OTC market	No single owner	No single name of network	CCASS (HKEx),	HKEx (CCASS)	Message protocol comparable with ISO 015022 (CCASS)
	Hong Kong Stock Exchange	HKEx	Message protocol comparable with ISO 015022	CMUP (CMU)	Hong Kong Monetary Authority (CMUP)	SWIFT (CMU)
Indonesia	OTC market	–	Not connected	BI-SSSS	BI	Proprietary network SNA
	Indonesia Stock Exchange (IDX)	–	Not connected	C-BEST	KSEI	–
Japan	Tokyo (OTC) market	No single name nor operator	No single name of network	PSMS	JASDEC	Proprietary network
	TSE market	TSE	No single name of network	TSE derivatives trading system	TSE	Name: TSE arrownnet Protocol: FIX and TSE protocol
Republic of Korea	KRX market	KRX	No name of the network	No name of the system	KRX	Proprietary network for KRX, TCP/IP
	OTC market	No owner or operator	No name of the network	Bond Institutional Settlement System	KSD	Proprietary network for KSD, TCP/IP
Lao PDR	–	–	–	–	–	–
Malaysia	OTC securities market	–	–	–	–	–
Myanmar	–	–	–	–	–	–
Philippines	PDEX FI Spot Market, Repo Program, Lending Program	Philippine Dealing and Exchange Corp., part of the PDS Group SGX Ltd., Computershare Philippines and Tata Consultancy Services, India	Proprietary network	PDEX FI Trading System for spot, repo and securities lending	Philippine Dealing and Exchange Corp.	Proprietary network Frame Relay/Leased Line, Internet via Firepass, dial-up
Singapore	–	–	–	–	–	–
Thailand	BEX	The Stock Exchange of Thailand	SETNET	BEX	The Stock Exchange of Thailand	SETNET
Viet Nam	HNX	Owner: Ministry of Finance	Proprietary	No specific name	HNX and HOSE	Proprietary TCP/IP
	HOSE	Operator: HNX, HOSE, VSD				

– = no information.
Source: ABMF SF2.

Table A1.1 Bond Market Infrastructures in ASEAN+3 (continued)

1.5 Clearing System			1.6 Cash Settlement System				
1.5.1 Name of clearing system	1.5.2 Owner and Operator of Clearing System	1.5.3 Name of Network and Protocol	1.6.1 Name of Cash Settlement System	1.6.2 Owner and Operator of Cash Settlement System	1.6.3 Name of Network and Protocol	1.6.4 DVP and BIS Model	1.6.5 Intraday Overdraft and Liquidity Saving Features
–	–	–	–	–	–	–	–
–	–	–	–	–	–	–	–
SHCH has launched CCP service from Dec. 19, 2011. Currently, it is used for bonds deposited by SHCH.			HVPS (CNAPS)	PBoC	Proprietary network TCP/IP	Model 1	Yes
No single name	CSDCC	–	No single name	CSDCC	PROP, IST	Model2	Yes
N/A	N/A	N/A	Clearing House Automated Transfer System	Owners: HKMA, HSBC; Standard Chartered Bank (Hong Kong) Limited Bank of China (Hong Kong) Limited. Operator: HKICL	SWIFTNet InterAct and InterBrowse	Model 1 and Model 3	Yes
–	–	–	BI-RTGS	BI	Proprietary network SNA	Model 1	Yes
E-BOCS	KPEI				–	Model 2	
JGBCC system	JGBCC	No specific name	BOJ-NET FTS	BOJ	Proprietary network TCP/IP	Model 1	Yes
JSCC system	JSCC	No specific name					
No name of the system	KRX	Proprietary network for KRX, TCP/IP	BOK-Wire+	BOK	Proprietary network for BOK, TCP/IP	Model 3	N/A
Bond Institutional Settlement System	KSD	Proprietary network for KSD, TCP/IP				Model 1	BOK provides intraday overdraft through self-collateral repo from November 2011.
–	–	–	–	–	–	–	–
Securities/ Equities Clearing	Bursa Malaysia Securities Clearing	–	RENTAS	MyClear	–	–	–
–	–	–	–	–	–	–	–
Expanded Delivery vs. Payment System (eDVP)	Philippine Dealing and Exchange Corp.	Proprietary network Browser-based internet access	Philippine Payments and Settlement System	BSP	SWIFT, proprietary dial-up, computer-to-computer interface with clearing systems	Model 1	Yes
RoSS-PhilPaSS DVP System	Bureau of the Treasury	Proprietary network Point-to-point leased line					
–	–	–	–	–	–	–	–
PTI	The Stock Exchange of Thailand	SETNET	BAHTNET	Bank of Thailand	N/A	Model 1	Yes
SATS	VSD	Proprietary	No specific name	BIDV	N/A	Model 1, and Model 3	None

– = no information.
Source: ABMF SF2.

Table A1.2 Central Securities Depositories in ASEAN+3

Country	2.1 Name of CSD	2.2 Owner and Operator	2.3 Type of Bonds and Dematerialization	2.4 Number of Stakeholders	2.5 List of Transactions
Brunei Darussalam	–	–	–	–	–
Cambodia	–	–	–	–	–
People's Republic of China	CCDC	Owned by the state, operated by CCDC	Government bond, Central bank bills, bank bond, enterprise bond, asset-backed security and Panda bond Paperless and kept in custody in book-entry system.	10,235 institutional participants	FOP, DVP, PAD, DAP
	SHCH	Owned by CFETS, CCDC, CBPMC, and China Gold Coin Co., operated by SHCH	Commercial paper (CP), Super & short-term commercial paper (SCP), Private placement note (PPN), Credit risk mitigation warrant (CRMW), etc.	More than 2,000 participants	FOP, DVP, PAD, DAP
	CSDCC	Operated by its own management and staff	Stocks, Treasury bonds, local government bonds, enterprise bonds, corporate bonds, convertible bonds, repo, exchange-traded fund, warrants, and asset-backed securities.	–	–
Hong Kong, PRC	CMU	The HKMA	Exchange fund notes and bills, government bonds, securities issued by public corporations and supranational Book-entry form (dematerialized) for exchange fund paper and global note form for corporate bonds	156 CMU members	Real time and end-of-day DVP and FOP for all CMU securities
Indonesia	KSEI	Owners: IDX, KPEI, custodian banks, brokerage firms and registrars. Operator: KSEI	Stocks, warrants, exchange-traded fund, participation unit of limited participation mutual fund, corporate bonds, government bonds, Sharia bonds (Sukuks), Certificate of Bank Indonesia (SBI), medium-term notes, promissory notes, and asset-backed securities	Refer to 2.2	For government bonds, BI requires all trades to be settled on against payment basis
	Bank Indonesia Scripless Securities Settlement System (BI-SSSS)	BI	Government bonds (conventional and Sharia), government debt securities (conventional and Sharia), and Central Bank Certificates (SBI, conventional and Sharia)	BI, MoF (Debt Management Office), Banks, Sub-registries (including KSEI), Brokerage Firms	DVP, FOP, issuance, purchase and sale, interest payment, redemption, repo
Japan	BOJ (BOJ-NET)	BOJ	Japanese Government bonds (JGB) Most government bonds are dematerialized	313 including domestic banks, foreign banks, securities companies, insurance companies, and others	DVP, FOP, issuance, interest payment, and redemption
	JASDEC Book-Entry Transfer System for Corporate Bonds, etc.	JASDEC	All types of bonds except JGB paperless book-entry	3384 including issues, JASDEC participants, indirect asset management institutions, and agents	–
Republic of Korea	KSD	KSD	All the bonds are deposited in a registered form. CD and CP are issued with physical certificates.	257 institutions as of the end of 2010	DVP, FOP
Lao PDR	–	–	–	–	–
Malaysia	MyClear RENTAS	MyClear	–	–	–
Myanmar	–	–	–	–	–
Philippines	Philippine Depository and Trust Corp.	Philippine Dealing System Holdings Corp.	Government securities and corporate bonds are 100% dematerialized Short-term corporate bonds–CSD ready to accept in dematerialized form; discussions ongoing with market players	Brokers = 26 Dealers = 33 Institutional investors (direct depository participants) = 3 Custodians = 4 Sponsored investor accounts (opened/maintained by a sponsor broker/dealer) = 1,200	Settlement of trades in the PDEX spot, repo and securities lending transaction (SLT) markets
Singapore	–	–	–	–	–
Thailand	TSD	The Stock Exchange of Thailand	All government bonds and corporate bonds are dematerialized.	Domestic banks, foreign banks and securities companies	TSD acts as the sole depository and settlement agent of bonds.
Viet Nam	VSD	Owner: Government (MOF), Operator: VSD	Government bonds, FCY-dominated bond and corporate bonds All bonds are registered at VSD in form of book entry	Only the government	DVP

– = no information.
Source: ABMF SF2.

Table A1.2 Central Securities Depositories in ASEAN+3 (continued)

2.6 Network					2.7 Link with Other CSDS
2.6.1 Name of the Network	2.6.2 Type of Lines	2.6.3 Protocol	2.6.4 Interface	2.6.5 Message Format	
–	–	–	–	–	–
–	–	–	–	–	–
Proprietary network	ISDN and dial-up combined	TCP/IP, HTTP, and SOAP	MQ	XML and Text message	CSDCC Outbound links with HK CMU and Clearstream
Proprietary network	ISDN and dial-up combined	TCP/IP, HTTP	MQ	XML and Text message	
No single name	Local participants rent fiber optics and satellite station while overseas customers use dial-up	TCP/IP	–	DBF and TXT	–
SWIFTNet	Leased line and Internet	TCP / IP	SWIFTNet InterAct and InterBrowse	ISO15022	Bilateral: Euroclear, Clearstream, Austraclear New Zealand, Korea Securities Depository (KSD) Unilateral: CMU has an account at Austraclear in Australia China CDC has an account at CMU
–	Fiber optics, leased line, ISDN, and dial-up	TCP/IP	OAQ Oracle database	XML and Text message	KSEI is linked to BI (central bank) for government bonds
Proprietary network	Leased line and dial-up	SNA	Proprietary (FTP) and socket	Proprietary	None
BOJ-NET	IP-VPN	TCP/IP	CORBA	Proprietary. ISO15022 messages formats are also adopted for some transactions under the current BOJ-NET.	None
JASDEC network	ISDN and leased lines	TCP/IP	–	ISO 15022 and CSV	None
SAFE+	Leased line: FEP (front end processor-Internet: SAFE+	–	–	–	–
–	–	–	–	–	–
–	–	–	–	–	–
–	–	–	–	–	–
Proprietary	Internet and point-to-point leased line	HTTPS	Browser-based, e.g., Internet Explorer	Proprietary	No computer-to-computer linkage with other CSDs or ICSDs, but PDTC operates an account with Clearstream and has opened an account with SGX-CDP
–	–	–	–	–	–
SETNET	Leased line	TCP/IP, HTTPS	PTI Terminal	N/A	None
Proprietary network	Leased line, IP-VPN, MPLS	TCP/IP	Terminal	XML	No

– = no information.
Source: ABMF SF2.

Table A1.3 Standards Including Numbering and Coding in ASEAN+3

Country	6.1 Securities Numbering			6.2 Financial Institution Identification			6.3 Securities Account	
	6.1.1 Use of ISIN for All Bond Transactions	6.1.2 Other Coding Schemes	6.1.3 Conversion between Local Numbering and ISIN	6.2.1 Coding Scheme Used	6.2.2 Conversion between BIC and Local Codes	6.2.3 Manual Operations	6.3.1 Use of ISO 20022	6.3.2 Other Coding Schemes
Brunei Darussalam	–	–	–	–	–	–	–	–
Cambodia	–	–	–	–	–	–	–	–
People's Republic of China	ISIN is not used for bond trades or settlement.	Proprietary securities numbering	Conversion table is planned to be created in the system	Proprietary participant code	By creating the conversion table in the system	N/A	Not used	Proprietary account code
Hong Kong, PRC	Yes	-CMU Issue Number -Common Code	ISIN, Common Code and CMU Issue Number are kept in the system database when available	CMU Member Account Number is assigned by internal coding scheme in CMU CCASS Participant Number is assigned by HKEX	CMU: No need to convert because system database can include both BIC and local codes	No	No	Proprietary coding scheme
Indonesia	Yes	Local code	Yes	Both BIC and current proprietary codes	No	No	No.	No
Japan	No	Proprietary securities numbering	No	Proprietary participant code	No	–	No.	Current proprietary account structure.
Republic of Korea	Yes	Local code scheme	Local short code is composed of basic code 9 digit of ISIN	KSD uses account number as an identification number	If necessary, mapping BIC onto local code is executed	N/A	N/A	Please see Part 2
Lao PDR	–	–	–	–	–	–	–	–
Malaysia	–	–	–	–	–	–	–	–
Myanmar	–	–	–	–	–	–	–	–
Philippines	ISINs and local proprietary	For corporate bonds, a 12-character code	It is possible to convert between local numbering and ISIN	PDS-assigned firm codes	Using mapping tables	–	Yes	N/A
Singapore	–	–	–	–	–	–	–	–
Thailand	Yes	N/A	N/A	BIC code	N/A	–	No	Use an account number to transfer the bonds
Viet Nam	Yes	Local code	Automatically converted by VSD's proprietary system	N/A	N/A	N/A	No	Local securities account

– = no information.
Source: ABIMF SF2.

Table A1.3 Standards Including Numbering and Coding in ASEAN+3 (continued)

6.3 Securities Account		6.4 Cash Account				6.5 Character Code and Language		
6.3.3 Account Identification	6.3.4 Manual Operations	6.4.1 Use of IBAN code	6.4.2 Other Coding Schemes	6.4.3 BBAN	6.4.4 Manual Operations	6.5.1 Use of Unicode	6.5.2 Other Coding Schemes	6.5.3 Opinion for Standard Language
–	–	–	–	–	–	–	–	–
–	–	–	–	–	–	–	–	–
Not used	N/A	Not used	Proprietary account code	Not used	N/A	UTF 8	-	Need to make a standard conversion rule
N/A	No	No	CMU member code	N/A	Not under normal operations	Character set supported by SWIFT	N/A	Yes
No	No	No	Local cash account	Not used	No	No	No	No
Proprietary account identification is used.	–	No	Proprietary account identification.	No	–	No	No	JIS (Japanese Industrial Standard)
Please see Part 2	N/A	No for local transaction	Proprietary account number	If necessary, mapping IBAN onto proprietary code is executed	N/A	No	KSC 5601 for Korean ASCII for English	–
–	–	–	–	–	–	–	–	–
–	–	–	–	–	–	–	–	–
–	–	–	–	–	–	–	–	–
Business Partner ID (BPID)	Transfers of securities into (or out of) the depository	No	The BIC code of the bank, the regular bank account number	N/A	No manual intervention for trades of banks	Yes	N/A	Yes
–	–	–	–	–	–	–	–	–
–	No	No	The Bank of Thailand account number as the reference to transfer the fund	No	–	English/UTF-8	–	–
Yes	No	N/A	N/A	N/A	N/A	UTF-8	No	Further clarification

– = no information.
Source: ABMF SF2.

Appendix 3.1

Description of Model Cross-Border Bond Flow

Figure A1.1 Model Cross-Border Bond Flow

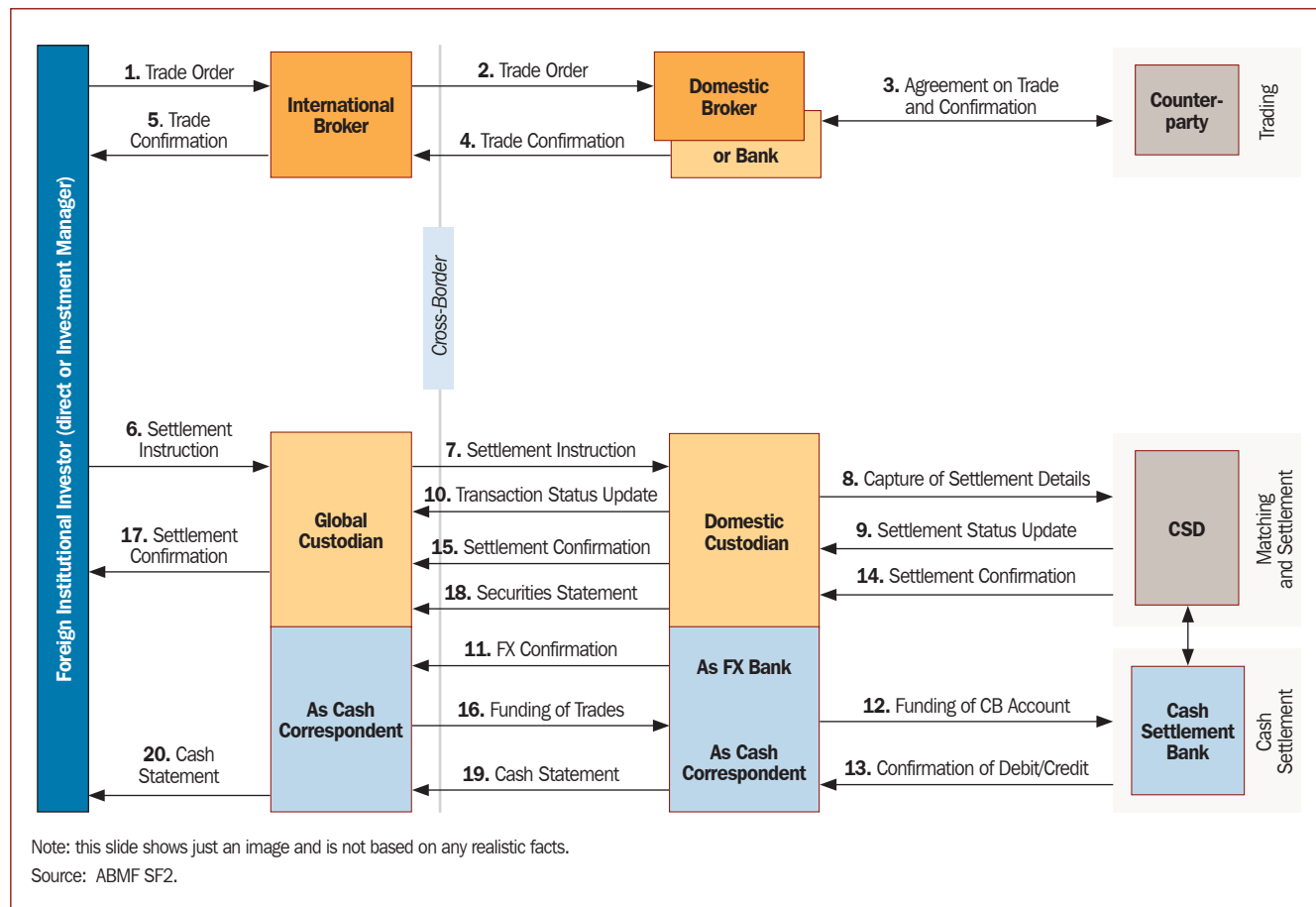

Trade Date

1. Foreign Institutional Investor places order with International Broker
2. International Broker places order with Domestic Broker
3. Domestic Broker/Bank trades OTC with Counterparty (via phone, Bloomberg, etc.)
4. Domestic Broker/Bank sends trade confirmation to International Broker
5. Foreign Institutional Investor receives trade confirmation
6. Foreign Institutional Investor instructs Global Custodian on securities settlement details and funding details

T+1

7. Global Custodian instructs Domestic Custodian on securities settlement and FX/funding details (in a single instruction or message)
8. Domestic Custodian transmits settlement details to CSD (capture, upload, or messaging)

9. Domestic Custodian obtains settlement status updates (single arrow shown: active 'sending' of confirmation from CSD)
10. Domestic Custodian communicates settlement status updates to Global Custodian

Settlement Date

11. Domestic Custodian sends FX confirmation to Global Custodian, on required FCY amount
12. Domestic Custodian funds account with central bank or cash clearer
13. Upon transfer of cash, debit/credit confirmation available from central bank/cash clearer (single arrow shown: active 'sending' of confirmation from central bank/cash clearer)
14. Upon transfer of securities, settlement confirmation available from CSD (single arrow shown: active 'sending' of confirmation from CSD)
15. Domestic Custodian sends settlement confirmation for securities and cash to Global Custodian
16. Global Custodian funds Domestic Custodian's nostro account, at FCY correspondent bank, in FCY (before end of day)
17. Global Custodian sends settlement confirmation to Foreign Institutional Investor
18. Domestic Custodian sends securities statement to Global Custodian
19. Domestic Custodian sends cash statement to Global Custodian
20. Global Custodian sends cash statement to Foreign Institutional Investor

Note: T+1 and Settlement Date could be the same date.

Appendix 3.2

Roles and Needs of Stakeholders of Cross-Border Bond Trade and Settlement

The roles of a foreign institutional investor (FII) or investment manager (IM) include the following.

- 1) **Investment decision making and order placement.** An FII or IM makes an investment decision and places an order with an International Broker, Domestic Broker, or Bank to act on an investment decision (whether or not the FII or IM places the order through a central dealing function or is directly of no consequence for this flow).
- 2) **Receive trade confirmation.** An FII or IM books on a trade-date basis, and the trade confirmation literally determines all displays, processes, reports, and accounting.
- 3) **Send settlement instruction.** As a required step to kick off the settlement process, an FII or IM sends the settlement instruction to a Global Custodian (GC), or Domestic Custodian (DC) in case of a direct relationship.
- 4) **Receive settlement confirmation.** An FII or IM receives settlement confirmation with accounting for the trade done upon trade, and provides critical status update on whether cash or securities are effectively available. FIIs or IMs tend to calculate their positions based on trade entries and settlement confirmations, and periodically reconcile positions with intermediaries' statements (hence, often does not expect to receive daily securities statement).
- 5) **Receive daily cash statement.** An FII or IM receives daily cash statement regardless of trade volume to check and adjust funding position.

The roles of a GC include the following:

- 1) **Receive settlement instruction from FII or IM.** A GC receives settlement instruction from an FII or IM which is required to kick off settlement process and its own processes, including debit or credit of client account(s).
- 2) **Send settlement instruction to Domestic Custodian.** A GC sends settlement instruction to a DC at the place of settlement (PSET, according to industry or SWIFT), which requires that the DC be notified of securities and cash instructions, and kick off the domestic settlement process.
- 3) **Receive transaction status update notification.** A GC receives a transaction status update notification or message to determine funding requirements by settlement date across PSET and currencies (depending on settlement cycle and specific client requests, which could be a re-iterative process) to kick off funding in LCY or FCY where required.
- 4) **Receive FX confirmation from Domestic Custodian.** A GC receives an FX confirmation from a DC for effective FCY amount required, in case FX for transaction is requested by GC, based on transaction status information for trade or across trades.
- 5) **Receive settlement confirmation.** Custodians book on a settlement-date basis, hence, the critical importance of this receipt to trigger onward confirmation to FII or IM, and to kick off FCY payments as well as for accounting entries.
- 6) **Send settlement confirmation to FII or IM.** A GC sends a settlement confirmation to the FII or IM based on confirmation from DC.
- 7) **Send funding instruction and message, and arrange funding.** A GC sends funding instruction and message as well as arranges funding into the DC's nostro (for FCY) or direct account (for LCY) to fund daily securities transactions. Messaging and payments process are often integrated.

- 8) **Receive securities statement(s) from DC.** To be able to reconcile all securities movements with end-of-day positions, a GC receives securities statement(s) from the DC, which is critical due to very high volume across typically 100+ markets' coverage.
- 9) **Receive cash statement(s) from DC.** To be able to reconcile all cash movements with end-of-day cash positions, a GC receives cash statement(s) from the DC. This is critical due to very high volume of cash entries across 10-20 currencies, and extremely high volume across main funding currencies.
- 10) **Send daily cash statement(s) to FII or IM.** A GC sends daily cash statement(s) to an FII or IM regardless of trade volume to advise the cash position resulting from the day's booking activities, across currencies.

The roles of a DC include:

- 1) **Receive settlement instruction from GC.** A DC receives settlement instruction from a GC, which is required to kick off the domestic settlement process and its own processes. This is also done to make sense of a broker confirmation or market notification potentially received prior to settlement instruction (where applicable). A foreign exchange instruction, if required, is typically included in this.
- 2) **Obtain confirmation of correctness of details of transaction.** A DC obtains confirmation of the correctness of the details of the transaction to be settled, which is typically a part of the next two steps.
- 3) **Capture, message or upload settlement transaction details.** A DC captures, messages, or uploads settlement transaction details into a central securities depository (CSD) to service domestic settlement process.
- 4) **Receive transaction status update from settlement counterparty or CSD.** A DC receives information on transaction status update from a settlement counterparty or CSD either by communicating with a counterparty, through eyeballing/manual retrieval, or notification/message from the CSD or the pre-matching system to trigger a status update message to the GC, and to calculate effective funding amount to central bank (CB) or cash clearer.
- 5) **Send transaction status update notification or message to GC.** A DC sends a transaction status update notification or message to a GC based on the status update from the market.
- 6) **Send FX confirmation to GC.** For the FCY amount required a DC sends an FX confirmation to a GC and if the FX for transaction is requested by the GC. The confirmation is based on transaction status information for trade or across trades.
- 7) **Receive funding notification from GC.** A DC receives funding notification from a GC to determine where funding will come from, in LCY or FCY, and to potentially drive client cash account entries.
- 8) **Fund cash or clearing account with CB or cash clearer.** A DC funds the cash or clearing account with the CB or cash clearer based on funding instructions or message from the GC based on client cash account entries.
- 9) **Receive securities settlement confirmation.** A DC receives a securities settlement confirmation either by eyeballing or manual retrieval, or notification or message, from the CSD to transfer securities in its books in accordance with market settlement, and to trigger settlement confirmation to the GC.
- 10) **Receive cash settlement confirmation.** A DC receives a cash settlement confirmation either by eyeballing or manual retrieval, or notification or message, from the CB or cash clearer to have an evidence of finality of trade, and to be able to send cash statement to the GC.

- 11) **Send a combined settlement confirmation to GC.** A DC sends a combined settlement confirmation based on confirmations from the CSD, CB or cash clearer.
- 12) **Send securities statement(s) to GC.** A DC sends securities statement(s) to the GC for the GC, and effectively the DC, to be able to identify if securities movements may have been booked through the incorrect account. This step is critical where multiple client sub-accounts are involved.
- 13) **Send cash statement(s) to GC.** A DC sends securities statement(s) to the GC for the GC, and effectively the DC, to be able to identify if cash entries may have been booked through the incorrect account. This step is critical where multiple accounts, funding, and settlement currencies are involved.

The roles of the Central Securities Depository (CSD) include:

- 1) **Receive settlement details for specific securities transaction.** The CSD receives settlement details for (each) specific securities transaction from both settlement counterparties in the form of manual capture (whether at proprietary terminal, web based, or through a participant's screen), messaging, or data uploading. However, the form of receipt of information is not critical to CSD since the next, and crucial, steps are internal; in addition, strict cut-off times often exist for receipt of data.
- 2) **Make information on status of transaction.** The CSD makes information on the status of transaction available for the benefit of the settlement counterparties.
- 3) **Send request for funding to CB or cash clearer.** The CSD sends a request for funding to the CB or cash clearer following conditions conducive for settlement, i.e., matched transaction.
- 4) **Receive confirmation of cash transfer or settlement from CB or cash clearer.** The CSD receives confirmation of cash transfer or settlement from the CB or the cash clearer to effect transfer of securities between settlement counterparties.
- 5) **Make available confirmation of settlement-to-settlement counterparties.** As conclusion of settlement, the CSD makes available the confirmation of settlement-to-settlement counterparties.

The roles of the CB or Cash Clearer include:

- 1) **Receive request for funding from CSD.** The CB or cash clearer receives the request for funding from the CSD as a trigger for its own cash settlement process.
- 2) **Make available information on status of transaction or funding request.** The CB or cash clearer makes available information on status of transaction or funding request for the benefit of the settlement counterparties (for pending transaction, insufficient funds, etc.).
- 3) **Make available confirmation of cash transfer or settlement to CSD and to settlement counterparties.** As conclusion of the cash part of settlement, and to provide CSD with trigger for transfer of securities, and participants with part-trigger for settlement confirmation, the CB or cash clearer makes available the confirmation of cash transfer or settlement to the CSD and to the settlement counterparties.

Appendix 4

Information Sessions of ASEAN+3 Bond Market Sub-Forum 2

1st ABMF SF2 on 28 September 2010 in Tokyo, Japan

- No information session

2nd ABMF SF2 on 14 December 2010 in Manila, Philippines

- *Will Transaction Costs be High in Asia?: A Global Custodian's View.* Presentation by Mr. Mike Tagai, J.P. Morgan
- *How to Make Efficient and Effective Discussion to Set Standards: Lessons from the EU and SMPG, and Tips for a Successful International Discussion.* Presentation by Mr. Alex Kech, SWIFT Standards
- *How to Make International IT Developments Successful.* Presentation by Sun Gard

3rd ABMF SF2 on 17 February 2011 in Kuala Lumpur, Malaysia

- *Regional Custodian Business Chain and Major IT Obstacles for HSBC* by Mr. Patrick Cichy, HSBC Securities Service.
- *Pre-Settlement Matching System (PSMS) etc.* by Mr. Shunichiro Unno and Mr. Yuji Sato, JASDEC

4th ABMF SF2 on 1 July 2011 in Jeju Island, Republic of Korea

- *How Omgeo can Contribute Standardization and Harmonization,* by Mr. Hong Keun Park and Mr. Yuji Tanaka, Omgeo

5th ABMF SF2 on 13 September 2011 in Bali, Indonesia

- *Better IT Infrastructure to Improve Bond Market Information Collection.* Presentation by KOSCOM
- *Europe's Efforts after Giovannini Report.* Presentation by Mr. Sebastien Cochard, BNP Paribas
- *ECB's Target 2 Securities and Implication for Asia.* presentation by Mr. Taketoshi Mori, Bank of Tokyo-Mitsubishi UFJ

Appendix 5

Respondent-Institutions During SF2 Country Visits

PRC	Bank of China
PRC	China Central Depository and Clearing Co. Ltd.
PRC	China Construction Bank
PRC	China Foreign Exchange Trade System
PRC	China Securities Depository and Clearing Corporation Limited Shanghai
PRC	China Security Regulatory Commission
PRC	HSBC Shanghai
PRC	Industrial and Commercial Bank of China Limited
PRC	National Association of Financial Market Institutional Investors
PRC	People's Bank of China
PRC	Shanghai Clearing House
PRC	Shanghai Stock Exchange
PRC	Zhong Lun Law Firm
HKG	Hong Kong Monetary Authority
HKG	HSBC
HKG	J.P. Morgan
HKG	Slaughter and May, Hong Kong Office
HKG	State Street
INO	Bank Indonesia
INO	BAPEPAM-LK, Indonesia Capital Market and Financial Institution Supervisory Agency
INO	Deutsche Bank AG
INO	HSBC
INO	Indonesia Central Securities Depository
INO	Indonesia Clearing and Guarantee Corporation
INO	Indonesia Stock Exchange
MAL	Bank Negara Malaysia
MAL	CIMB
MAL	Citi Corp
MAL	Deutsche Bank AG
MAL	HSBC
MAL	Standard Chartered
PHI	Bangko Sentral ng Pilipinas
PHI	Deutsche Bank AG
PHI	HSBC

PHI	ING Commercial Banking
PHI	Philippines Depository and Trust Corporation
PHI	Sycip Salazar Hernandez and Gatmaitan
THA	Securities and Exchange Commission Thailand
THA	The Stock Exchange of Thailand
THA	Bank of Thailand
THA	Thailand Securities Depository
THA	HSBC
THA	Siam Premier International Law Office Limited
THA	Standard Chartered
THA	Thai BMA
VIE	Allens Arthur Robinson
VIE	Bank for Investment and Development of Vietnam
VIE	Citibank
VIE	Deutsche Bank AG
VIE	Hanoi Stock Exchange
VIE	HSBC
VIE	Standard Chartered
VIE	State Bank of Vietnam
VIE	State Securities Commission
VIE	Viet Nam Bond Market Association
VIE	Vietnam Securities Depository

Abbreviations

ABMI	– Asian Bond Markets Initiative
ABMF	– ASEAN+3 Bond Market Forum
ABS	– Asset-Backed Securities
ADB	– Asian Development Bank
ADI	– Authorized Depository Institution
AEC	– ASEAN Economic Community
AFT	– Auto-feeding of concluded transactions on electronic trading platform at Bloomberg
AITTS	– Automated Inter-bank Trading System
AMRO	– ASEAN+3 Macro-economic Research Office
ANNA	– Association of National Numbering Agencies
ASEAN	– Association of Southeast Asian Nations
ASEAN+3	– ASEAN, People’s Republic of China, Japan, and Republic of Korea
BAPEPAM-LK	– Badan Pengawas Pasar Modal Bapepam dan Lembaga Keuangan, Indonesia Capital Market and Financial Institution Supervisory Agency
BAHTNET	– Bank of Thailand Automated High Value Transfer Network
BBAN	– Basic Bank Account Number
BBCA	– PT Bank Central Asia Tbk
BCS	– Bursa Clearing and Settlement System
BEX	– Bond Electronic Exchange
BI	– Bank Indonesia
BIC	– Business Identifier Code
BIDV	– Bank for Investment Development of Vietnam
BIS	– Bank for International Settlements
BISS	– Bond Institutional Settlement System
BI-SSSS	– Bank Indonesia-Scripless Securities Settlement System
BM	– Bursa Malaysia
BMA	– Thai Bond Market Association
BMD	– Bursa Malaysia Depository
BMRI	– PT Bank Mandiri Tbk
BMSC	– Bursa Malaysia Securities Clearing Sdn Bhd

BRU	–	Brunei Darussalam
BNGA	–	PT Bank CIMB Niaga Tbk
BNLI	–	PT Bank Permata Tbk
BNM	–	Bank Negara Malaysia
BOJ	–	Bank of Japan
BOJ-NET FTS	–	BOJ-NET Funds Transfer System
BOK	–	Bank of Korea
BOK-Wire+	–	New Bank of Korea Financial Wire Network System
BOT	–	Bank of Thailand
BQS	–	OTC Bond Quotation System
BSP	–	Bangko Sentral ng Pilipinas
BSRD	–	Bangko Sentral Registration Document
BTr	–	Bureau of Treasury
B-TRiS	–	Bond-Trade Report and Information Service
BTS	–	Bursa Trade System
C-BEST	–	Central Depository and Book-Entry Settlement
CBGS	–	Central Bond General System
CBPMC	–	China Banknote Printing and Minting Co.
CCDC	–	China Central Depository and Clearing
CCP	–	Central CounterParty
CD	–	Certificate of Deposit
CDP	–	Central Depository (Pte.) Limited
CDS	–	Credit Default Swap
CFETS	–	The China Foreign Exchange Trade System
CHATS	–	Clearing House Automated Transfer System
CLS	–	Continuous Linked Settlement
CMU	–	Central Moneymarkets Unit
CMUP	–	Central Moneymarkets Unit Processor
CNAPS	–	China National Automatic Payment System
CNS	–	Continuous Net Settlement
COINS	–	Corporate Information Superhighway
CORBA	–	Common Object Request Broker Architecture
CP	–	Commercial Paper
CRM	–	Credit Risk Mitigation
CSD	–	Central Securities Depository
CSDCC	–	China Securities Depository and Clearing Corporation
CSRC	–	China Securities Regulatory Commission
CSSO	–	Clearing and Settlement Systems Ordinance (Hong Kong, China)
CSV	–	Comma Separated Value
CTP	–	Centralized Trading Platform
DAP	–	Delivery After Payment
DCSS	–	Debt Securities Clearing and Settlement System
DIFB	–	Deposit Insurance Fund Bonds
DTCC	–	The Depository Trust & Clearing Corporation

DVP	– Delivery versus Payment
e-BOCS	– Electronic Bond Clearing System
eDVP	– Expanded Delivery versus Payment System
ETF	– Exchange Traded Fund
ETP	– Electronic Trading Platform
FAST	– Fully Automated System for Issuing/Tendering
FCY	– Foreign Currency
FEP	– Front End Processor
FIE	– Fixed Income Exchange
FII	– Foreign Institutional Investor
FIMS	– Foreign Investment Management System
FITS	– Fixed Income Trading System
FIX	– Financial Information eXchange
FOP	– Free of Payment
FSC	– Financial Services Commission
FSCMA	– Financial Investment Services and Capital Markets Act
FSS	– Financial Supervisory Service
FX	– Foreign Exchange
GC	– Global Custodian
GoE	– Group of Experts
GSBS	– Government Securities Book-entry System
GSED	– Government Securities Eligible Dealers
HKG	– Hong Kong Special Administrative Region
HKAB	– Hong Kong Association of Banks
HKEx	– Hong Kong Exchanges and Clearing Limited
HKICL	– Hong Kong Interbank Clearing Limited
HKMA	– Hong Kong Monetary Authority
HNX	– Hanoi Stock Exchange
HOSE	– Ho Chi Minh Stock Exchange
HSBC	– Hong Kong and Shanghai Banking Corporation
HTTP	– Hyper Text Transfer Protocol
HVPS	– High Value Payment System
IBAN	– International Bank Account Number
ICSD	– International Central Securities Depository
IDIB	– International Development Institute Bond
IDX	– Indonesia Stock Exchange
IEPFS	– Integrated Electronic Platform for Fixed-income Securities
IFTS	– Interbank Funds Transfer System
IM	– Investment Manager
INO	– Republic of Indonesia
INTS	– Integrated Negotiating Trade System
IRC	– Investment Registration Certificate
ISDN	– Integrated Services Digital Network
ISIN	– International Securities Identification Number

ISO	– International Organization for Standardization
ISS	– Institutional Settlement Service
IST	– Integrated Settlement Terminal
JASDEC	– Japan Securities Depository Center Inc.
JGB	– Japanese Government Bond
JGBCC	– Japan Government Bond Clearing Corporation
JPN	– Japan
JPY	– Japanese Yen
JSCC	– Japan Securities Clearing Corporation
JSX	– Jakarta Stock Exchange
KGB	– Korean Government Bond
CAM	– Cambodia
KOFEX	– Korea Futures Exchange
KOFIA	– Korea Financial Investment Association
KOSDAQ	– Korean Securities Dealers Automated Quotations
KOR	– Republic of Korea
KPEI	– PT Kliring Penjaminan Efek Indonesia, Indonesia Clearing and Guarantee Corporation
KRX	– Korea Exchange
KSD	– Korea Securities Depository
KSEI	– PT Kustodian Sentral Efek Indonesia, Indonesia Central Securities Depository
KTB	– Korea Treasury Bond
KTS	– KRX Electronic Trading System for Government Bonds
LAO	– Lao People’s Democratic Republic
LCY	– Local Currency
LEI	– Legal Entity Identifier
MAS	– Monetary Authority of Singapore
MBS	– Mortgage-Backed Securities
MCB	– Minimum Cash Balance
MEPS+	– MAS Electronic Payment System plus
MLA	– Minimum Liquid Assets
MYA	– Myanmar
MNS	– Multilateral Netting System
MNS System	– Multilateral Net Settlement System
MOF	– Ministry of Finance
MOU	– Memorandum of Understanding
MQ	– Message Queue
MSB	– Monetary Stabilization Bonds
MTN	– Medium-Term Note
MAL	– Malaysia
NAFMII	– National Association of Financial Market Institutional Investors
NGTS	– New Generation Trading System
NIFC	– National Inter-bank Funding Center
NNAs	– National Numbering Agencies

NRBA	– Non-resident Baht Account
NRBS	– Non-resident Baht Account for Securities
OTC	– Over-The-Counter
PAD	– Payment After Delivery
PBOC	– People’s Bank of China
PD	– Principal Dealer
PDEx	– Philippine Dealing and Exchange Corporation
PDTC	– Philippine Depository and Trust Corporation
PHI	– The Republic of the Philippines
PhilPaSS	– Philippine Payments and Settlement System
PI	– Principal & Interest
PPN	– Private Placement Notes
PRC	– People’s Republic of China
PROP	– Participant Remote Operation Platform
PSET	– Place of Settlement
PSMS	– Pre-Settlement Matching System
PTI	– Post Trade Integration
PTS	– Proprietary Trading System
PVP	– Payment versus Payment
QFII	– Qualified Foreign Institutional Investor
QL	– Qualifying Liabilities
RENTAS	– Real-time Electronic Transfer of Funds and Securities
RoSS	– Registry of Scripless Securities
RP	– Repurchase Agreement (repo)
RPS	– Retail Payment System
RSI	– Regional Settlement Intermediaries
RTGS	– Real Time Gross Settlement
RVP	– Receive versus Payment
S	– Settlement day
S-1	– Settlement day - 1
SC	– Securities Commission of Malaysia
SCCS	– Securities Clearing and Computer Services Pte. Ltd
SCP	– Super & Short-term Commercial Paper
SD	– Settlement Day
SDH	– Synchronous Digital Hierarchy
SEC	– Securities and Exchange Commission
SET	– The Stock Exchange of Thailand
SF1	– Sub-Forum 1
SF2	– Sub-Forum 2
SGS	– Singapore Government Securities
SIN	– Singapore
SGX	– Singapore Exchange
SHCH	– Shanghai Clearing House
SI	– Settlement Institution

SIMEX	-	Singapore International Monetary Exchange
SNA	-	Systems Network Architecture
SOAP	-	Simple Object Access Protocol
SPEEDS	-	Sistem Pemindahan Elektronik Dana dan Sekuriti
SRC	-	Securities Regulation Code
SRO	-	Self-Regulatory Organization
SSC	-	State Securities Commission
SSDS	-	Scripless Securities Depository System
SSE	-	Shanghai Stock Exchange
SSS	-	Securities Settlement System
SSX	-	Surabaya Stock Exchange
STFB	-	Short Term Financial Bond
STP	-	Straight Through Processing
SWIFT	-	Society for Worldwide Interbank Financial Telecommunication
SZSE	-	Shenzhen Stock Exchange
TCH	-	Thailand Clearing House
TCP/IP	-	Transmission Control Protocol/Internet Protocol
T	-	Trade date
T+1	-	Trade date + 1
T+2	-	Trade date + 2
T+3	-	Trade date + 3
T+4	-	Trade date + 4
TF3	-	Task Force 3
TFEX	-	Thailand Futures Exchange
TFIIC	-	Thailand Financial Instruments Information Center
THA	-	The Kingdom of Thailand
THB	-	Thai Baht
TSD	-	Thailand Securities Depository
TSE	-	Tokyo Stock Exchange
UCS	-	Universal multiple-octet coded Character Set
UTF	-	Unicode Transform Format
VIE	-	Socialist Republic of Viet Nam
VPN	-	Virtual Private Network
VSD	-	Vietnam Securities Depository
XML	-	Extensible Markup Language

Part 2

Bond Markets and Their Infrastructures in Each Economy

Contents

People's Republic of China

1. Bond Market Infrastructure.....	1
2. Typical Business Flows.....	5
3. Matching	6
4. Settlement Cycle	7
5. Numbering and Coding	7
6. Medium- to Long-Term Strategy	8

Hong Kong, China

1. Bond Market Infrastructure.....	11
2. Typical Business Flows.....	17
3. Matching	17
4. Settlement Cycle	18
5. Numbering and Coding	18
6. Medium- to Long-Term Strategies.....	19

Indonesia

1. Bond Market Infrastructure.....	21
2. Typical Business Flows.....	25
3. Matching.....	26
4. Settlement Cycle	26
5. Numbering and Coding	26
6. Medium- to Long-Term Strategies.....	26

Japan

1. Bond Market Infrastructure.....	29
2. Typical Business Flows.....	31
3. Matching	32
4. Settlement Cycle	33
5. Numbering and Coding	33
6. Medium- to Long-Term Strategies.....	36

Republic of Korea.....	45
1. Bond Market Infrastructure.....	45
2. Typical Business Flows.....	51
3. Matching	52
4. Settlement Cycle	53
5. Numbering and Coding.....	53
6. Medium- to Long-Term Strategies.....	55
Malaysia.....	57
1. Bond Market Infrastructure.....	57
2. Typical Business Flows.....	61
3. Matching	62
4. Settlement Cycle	62
5. Numbering and Coding.....	62
6. Medium- to Long-Term Strategy	63
Philippines	64
1. Bond Market Infrastructure.....	64
2. Typical Business Flows.....	68
3. Matching	68
4. Settlement Cycle	69
5. Numbering and Coding.....	69
6. Medium- to Long-Term Strategies	69
Singapore	71
1. Bond Market Infrastructure.....	71
2. Typical Business Flows.....	74
3. Matching	74
4. Settlement Cycle	74
5. Numbering and Coding.....	74
Thailand	77
1. Bond Market Infrastructure.....	77
2. Typical Business Flows.....	81
3. Matching	81
4. Settlement Cycle	81
5. Numbering and Coding.....	81
6. Medium- to Long-Term Strategy	82
Viet Nam.....	83
1. Bond Market Infrastructure.....	83
2. Typical Business Flows.....	86
3. Matching	87
4. Settlement Cycle	87
5. Numbering and Coding.....	87
6. Medium- to Long-Term Strategies.....	88

Figures and Table

Figures

Figure 2.2	Hong Kong Multi-Currency Payment and Securities Settlement Infrastructure	15
Figure 2.4	Cross-Border Cross-Currency Delivery-versus-Payment Model	16
Figure 2.5	Conceptual Framework of the Common Platform Model.....	19
Figure 2.6	Conceptual Framework of the Pilot Platform	20
Figure 3.1	Secondary Market Flow.....	23
Figure 3.2	Registry System of Indonesian Government Bonds.....	24
Figure 3.3	Government Bonds Settlement between BI-SSSS and C-BEST.....	25
Figure 3.4	Comparison between the Existing System and the Second-Generation System	27
Figure 4.1	Local Numbering Scheme and Codes for International Securities Identification Number	33
Figure 4.2	Financial Institution Identification.....	34
Figure 4.3	Securities Account Structure	35
Figure 4.4	Character Code Sets and Language in the Japanese Settlement System.....	35
Figure A2.1	Domestic Transactions–Three-Party Center Matching Type (Without Using Investment Instruction Distribution Service).....	42
Figure A2.2	Non-Residents’ Transactions	44
Figure 5.1	Operation of FreeBond.....	46
Figure 5.2	Centralization and Disclosure of Over-the-Counter Quotations	47
Figure 5.3	Screen Image of the Bond-Trade Report and Information Service	48
Figure 5.4	Market Structure of the KRX Electronic Trading System for Government Bonds	49
Figure 5.5	Sample of Inbound Transactions in the Korea Bond Market	51
Figure 5.6	Sample of Outbound Transactions in the Korea Bond Market	52
Figure 5.7	Central Matching for Korea Exchange on the Over-the-Counter Market	52
Figure 5.8	Local Matching on Over-the-Counter Market.....	53
Figure 5.9	Sample of First Issued Korean Treasury Bond in 2006.....	54
Figure 5.10	Korea Securities Depository Code Structure	54
Figure 5.11	Basic Structure of Exchange Settlement of Korean Government Bonds	56
Figure 5.12	Basic Structure of Intraday RP System.....	56
Figure 6.1	Securities Account Structure in RENTAS	63
Figure 6.2	Cash Account Structure in RENTAS	63
Figure 7.1	Settlement through RoSS-PhilPaSS DVP	66
Figure 7.2	Settlement Process for Corporate Bond Trades and Government Bond Trades.....	67
Figure 8.1	Transaction Flow of Debt Securities Clearing and Settlement System.....	73
Figure 9.1	Role of the Thailand Clearing House.....	79
Figure 9.2	Process for Gross Settlement for DVP.....	80
Figure 10.1	Bond Settlement Process in the Viet Nam Bond Market	85
Figure 10.2	Cash Settlement Process in the Viet Nam Bond Market	86

Table

Table 3.1	Road Map for the Implementation of Second-Generation System	28
-----------	-------------------------------------------------------------------	----

People's Republic of China (PRC)

1. Bond Market Infrastructure

1.1 Overview of Bond Markets

People's Republic of China's bond market is comprised of the Inter-bank Bond Market and the exchange bond market. More than 99% of trades (by value) take place in the Inter-bank Bond Market.¹ This market is also called the "China over-the-counter (OTC) market." The China Foreign Exchange Trade System (CFETS), also known as the National Interbank Funding Center (NIFC), provides the electronic platform for the Inter-bank Bond Market.

Inter-bank Bond Market-traded bonds are settled through the China Central Depository and Clearing (CCDC) or the Shanghai Clearing House (SHCH), while exchange-traded bonds are settled through the China Securities Depository and Clearing Corporation (CSDCC). Currently, government bonds, policy bank bonds, central bank bills, and other instruments are settled by CCDC, while super and short-term commercial papers (SCP), commercial papers (CP), private placement notes (PPN), etc. are settled by SHCH. Cash are transferred through the high-value payment system (HVPS) of the China National Automatic Payment System (CNAPS), a type of real-time gross settlement (RTGS), which is operated by the People's Bank of China (PBOC). Shanghai Clearing House (SHCH) is designated to provide centralized clearing service in the Inter-bank Bond Market and slated for production operation near the end of year 2011. The PBOC is opening the Inter-bank Bond Market for cross-border trade.

Nonresidents need to access to the exchange markets—the Shanghai Stock Exchange (SSE) and Shenzhen Stock Exchange (SZSE)—as a qualified foreign institutional investor (QFII). Data traded on the exchange markets are transmitted to the CSDCC and settled using commercial bank money (Part 3, Figure A.1).

¹ There is a retail bond (OTC) market called the commercial bank counter market. Since the size of the market is negligibly small compared with the interbank bond market, it is not included in this survey.

1.2. Description of Related Organizations

China Foreign Exchange Trade System and National Interbank Funding Center (CFETS/NIFC)

CFETS, founded on 18 April 1994, is a sub-institution of the PBOC. Its main functions include: organizing and providing systems for foreign exchange (FX) trading, renminbi lending, bond trading, and exchange-rate and interest-rate derivatives trading; providing clearing, information, risk management, and surveillance services on interbank markets; and engaging in other businesses authorized by the PBOC. CFETS is also called ChinaMoney.

The Shanghai Stock Exchange (SSE)

SSE was founded on 26 November 1990 and began operations on 19 December 1990. It is a membership institution directly governed by the China Securities Regulatory Commission (CSRC). Membership of the SSE includes domestic brokers and a small number of foreign brokers. SSE deals with A-Shares, B-Shares, government, corporate and convertible bonds, and securities investment funds.

The Shenzhen Stock Exchange (SZSE)

SZSE, established on 1 December 1990, is a self-regulated legal entity under the supervision of CSRC. Its main functions include providing venue and facility for securities trading, formulating operational rules, arranging securities listing, organizing and supervising securities trading, offering membership supervision and oversight of listed companies, managing and publicizing market information and other capacities permitted by CSRC.

China Central Depository and Clearing Company, Limited (CCDC)

CCDC is a state-owned financial institution operating the China Bond Integrated Business System (CCDC system). CCDC mainly serves the Inter-bank Bond Market and also acts as general custodian for cross-market eligible issues. CCDC-eligible securities are dematerialized, including: Treasury bonds, local government bonds, policy bank bonds, agency bonds, commercial bank bonds, other financial bonds, enterprise bonds, commercial papers (CPs), medium-term notes (MTNs), mortgage-backed securities (MBS) and asset-backed securities (ABS), foreign bonds, domestic dollar bonds, among others. There are over 10,000 system members, including almost all financial institutions and various non-financial entities, as well as institutional investors. CCDC also provides nearly 9 million retail bond investors in the OTC market with inquiry service. CCDC business line covers issuance, registration, custody, settlement, principal and interest (PI) payment, and collateral management, as well as services on information, research, consultancy, training, and magazine production. CCDC establishes a proprietary network based on multi-telecommunications operator lines, with integrated services digital network (ISDN) and dial-up combined. CCDC has several links with central securities depositories (CSDs) and international CSDs (ICSDs), including the link with CSDCC, outbound links with Hong Kong Monetary Authority's Central Moneymarket Unit (CMU), and Clearstream. CCDC is also called ChinaBond.

China Securities Depository and Clearing Corporation (CSDCC)

CSDCC is owned by SSE and SZSE, and operates the CSDCC system for the exchange

market. CSDCC-eligible securities are dematerialized, which include: stocks, bonds,² warrants, exchange trade funds (ETFs), ABSs, and repo. CSDCC business line covers central registry and depository, wherein security companies and custodian banks act as sub-custodians. CSDCC is also known as ChinaClear.

Shanghai Clearing House (SHCH)

SHCH was authorized by the PBOC and the Ministry of Finance of China, and incorporated by the CFETS, CCDC, China Banknote Printing and Minting Company Limited (CBPMC), and China Gold Coin Corporation. SHCH aims to provide central counterparty (CCP) net clearing-based and CSD services for the interbank renminbi and FX market. SHCH currently provides CSD service for innovative instruments and money market tools of the inter-bank market, covering super and short-term commercial papers (SCP), commercial papers (CP), Credit Risk Mitigation (CRM) instrument, and private placement notes (PPN), etc. SHCH has established its proprietary business network through the Synchronous Digital Hierarchy (SDH). SHCH was established in November 2009 by a decree from the PBOC and the Ministry of Finance of China. It provides a CCP function to mitigate counterparty risk and settlement risks, following the Group of Twenty (G-20) recommendation. SHCH is currently focused on the interbank bond and both spot and derivatives FX markets.

1.3 Trading

1.3.1 Inter-bank Bond Market

The Inter-bank Bond Market is a wholesale OTC market also known as the China OTC market. The China OTC market started in 1997 and occupies a dominant position, accounting for more than 97% of trading in the entire market share in 2010. The market does not have a single owners, while the market is operated by CFETS. Participants in the Inter-bank Bond Market are institutional investors. It is a quote (price)-driven market trading government bonds, central bank bills, enterprise bonds, policy bonds,³ other financial bonds, subordinate bonds, short-term financial bill (STFB), US dollar-denominated bonds, international development institution bonds (IDIB), ABS, and MTN. The People's Bank of China (PBOC) supervises and regulates the Inter-bank Bond Market. In recent years, with market-oriented guidelines, the PBOC, together with relevant departments and the industry, implemented a series of measures to promote the development of the Inter-bank Bond Market. To this end, the PBOC also supervises and guides the National Association of Financial Market Institutional Investors (NAFMII).

Bonds are traded through the CFETS/NIFC and brokers or dealers. The Automated Interbank Trading System (AITS) of the CFETS has a trade-matching function. The AITS is linked with the Centralized Bond Book-Entry System of the CCDC and the Clearing Business Integrated Processing System of the SHCH to support a straight-through processing (STP) of the trading and settlement layers of the Inter-bank Bond Market. The market is regulated by the PBOC.

² Bonds include Treasury bonds, local government bonds, enterprise bonds, listed corporate bonds, and convertible bonds.

³ Policy bonds are issued by Chinese policy banks such as the State Development Bank, China Import and Export Bank, and China Agriculture Development Bank, and often represent subordinated debts.

1.3.2 Exchange Market

The exchange market is a retail market open to individuals and non-bank financial institutions. The market is owned and operated by the SSE and SZSE. In 1992, the stock exchanges started government bond trades, and by 1995, all government bonds are traded in the stock exchanges. To support STP, the exchanges are linked with the CSDCC. The market is regulated by the CSRC. Although the exchange market provides platforms for bond transactions, institutional investors prefer to transact bonds in the Inter-bank Bond Market.

1.4 Central Counterparty Clearing

1.4.1 Central Counterparty for Bonds Traded in the China Over-the-Counter Market

SHCH started to provide CCP service for bond transactions in the Inter-bank Bond Market since 19 December 2011. Currently, it is used for bonds deposited by the SHCH.

1.4.2 Central Counterparty for Bonds Traded in the Exchange Market

Bonds traded through the exchanges are netted through CCP, before they are settled at the CSDCC.

1.5 Bond Settlement

1.5.1 Bond Settlement in the China Over-the-Counter Market

Most bonds (or normal bonds), including government bonds traded in the China OTC market, are settled at the CCDC. However, new instruments such as super short term CP (SCP) are settled at SHCH. Normal bond transactions are matched by the Central Bond Integrated Services System and settled through the safekeeping account in the centralized bond book-entry system of the CCDC. The centralized bond book-entry system is linked with the AITS of CFETS to support STP of the trading and settlement layers of the Inter-bank Bond Market.

CCDC's network is a proprietary network. The types of lines are a combination of ISDN and dial up. The protocols used are Transmission Control Protocol/Internet Protocol (TCP/IP), Hyper Text Transfer Protocol (HTTP), and Single Object Access Protocol (SOAP). The interface is used Message Queue (MQ), and message formats use Extensible Markup Language (XML) and text.

For bonds deposited by the SHCH, trades are matched by the Clearing Business Integrated Processing System and settled by the Securities Settlement System of the SHCH after receiving transactions from CFETS.

SHCH has established its proprietary business network via a Synchronous Digital Hierarchy (SDH).

1.5.2 Bond Settlement in the Exchange Market

Bonds are traded through the exchanges and settled at the CSDCC after they have been netted also through the CSDCC, which also serves as the CCP.

Local participants use fiber optic lines and satellite network to access CSDCC's system. Overseas customers, on the other hand, use dial-up connections. The protocol is based on TCP/IP, and message formats are dBase's underlying file format (DBF) and text.

1.6 Cash Settlement

1.6.1 Cash Settlement Using Central Bank Money

Settlement of the bond transactions at the CCDC/SCH is simultaneously processed with cash settlement through the current accounts of HVPS of CNAPS in delivery-versus-payment (DVP) Model 1 of the Bank for International Settlements (BIS) definition. In 2004, the CCDC system linked to the HVPS, which achieved DVP for interbank bond trades. Institutions could also achieve DVP through commercial bank agents that have an account in HVPS. However, this route has not been utilized yet. So far, the overall DVP technical mechanism has been in place, with characteristics of RTGS, central bank money, and strongest finality as a true DVP. For bond transactions settled at the SHCH using DVP mode, cash settlement can be processed in three ways. Institutions who have accounts in HVPS could achieve DVP directly through HVPS. Institutions who do not have accounts in HVPS could achieve DVP either through commercial bank agents, or through their cash settlement accounts at the SHCH. The intraday liquidity facility includes intraday overdraft and collateralized lending is available. Collateralized lending will be used prior to the intraday overdraft. Overnight overdraft is not allowed.

A real-time monitoring system for securities is available for the Inter-bank Bond Market. The monitoring system provides a real-time platform to detect operating conditions, speeds up emergency responses, and significantly improves regulation effectiveness.

The Inter-bank Bond Market is based on a proprietary network using leased lines and dial-up lines provided by multi-vendors. The communication protocol is based on TCP/IP.

1.6.2 Cash Settlement using Commercial Bank Money

Cash settlement is done by CSDCC using Participant Remote Operating Platform (PROP) for SSE market's business and Integrated Settlement Terminal (IST) for SZSE market's business. DVP is settled by Model 2 of the BIS definition.

2. Typical Business Flows

2.1 Delivery-Versus-Payment Flowchart for the China Over-the-Counter Market

The DVP flowchart for the China OTC Market is shown in Part 3, Figure A.2.

2.2 Delivery-Versus-Payment Flowchart for the Exchange Market

The DVP flowchart for the exchange market is illustrated in Part 3, Figure A.3.

2.3 Delivery-Versus-Payment Flowchart for Cross-Border Transactions in the Over-the-Counter Bond Market

China is opening its OTC market (Inter-bank Bond Market) for cross border trades. The PBOC published a notice in August 2010 on renminbi investments by three kinds of institutions in the Inter-bank Bond Market in China on a pilot basis. Please refer to Appendix 1.

For the bond transaction flow for foreign investors in the OTC market, please refer to Part 3, Figure A.4.

2.4 DVP Flowchart for Cross-Border Transactions (Exchange Markets)

For bond transaction flows for foreign investors in the exchange market, please refer to Part 3, Figure A.5.

3. Matching

3.1 Inter-bank Bond Market

On the trading aspect, two matching mechanisms are introduced in the Inter-bank Bond Market through an electronic trading platform operated by CFETS—the bilateral negotiation method and the click-and-deal method. The bilateral negotiation method refers to negotiation on the quotation's key fields between the quotation's initiator and the counterparty. The deal is closed when the initiator and counterparty reach an agreement on key fields. Under the click-and-deal method, the initiator can place a click-and-deal quote in the market, which can be entered into two types. The first type is market-making quotation, which is entered by the market maker. The second is the non-market-making quotation, a one way buy-or-sell quotation, which is entered by any member including a market maker. A counterparty can select a quote and enter the amount he wants to trade and thus 'deal'. Besides, the CFETS electronic trading system provides limit-order functionality under the click-and-deal trading mode. A price limit order is a one-way buy-or-sell order that is matched with a click-and-deal quote. Since a price limit order cannot match with another price limit order, this trading mode is classified under the click-and-deal quote method.

CCDC/SHCH implements automated matching through DVP and FOP. If trade takes place in CFETS platform, CCDC/SHCH receives the data automatically. The CCDC/SHCH then asks both parties to confirm the trading order, and processes the settlement after the confirmations are matched. If counterparties trade outside CFETS system, one party needs to input settlement instruction into the CCDC/SHCH system. The CCDC/SHCH system automatically asks the other party to confirm. If not, CCDC/SHCH does not process settlement. After matching the order, CCDC/SHCH settles the trade in FOP or DVP, as requested by customers.

3.2 Exchange Market

Matching in the exchange market is integrated in its trading system. The SSE uses both the New Generation Trading System (NGTS) and the Integrated Electronic Platform for Fixed-income Securities (IEPFS) for bond trade. The SZSE system uses

the auction trade system and the Integrated Negotiating Trade System (INTS) for bond trade. The matching system is owned and operated by the exchange market it serves.

4. Settlement Cycle

The settlement cycle allows for any date agreed between the counterparties, although T+1 and T+0 are most common for OTC market. Net settlement for bond trades occurs on T+1 at 4:00 p.m., but funding needs to be arranged on the previous day and to be sent by 3:00 p.m. on T+1 for exchange market. Trading data is transferred from the stock exchanges to CSDCC on the trade date, and book-entry transfers are effectuated at end of day of the trade date. If funds are not provided to the client's account, bonds will be withheld by CSDCC until the settlement is cleared. The failed party pays a penalty. CSDCC also supports securities lending transactions and its system supports STP from and to participants.

The standard settlement cycle of trade in government bonds to the settlement is T+1. The reasons for the differences between settlement cycles of typical business processes are: (1) market infrastructure and principle, (2) differences in settlement complexity, and (3) differences in participants' risk level. At present, there is no initiative to shorten settlement cycles. Also, such an initiative should be led by market participants.

5. Numbering and Coding

Both the CCDC and CSDCC settle government-bonds numbering and coding. The numbering and coding process for each CSD is further elaborated below.

5.1 Numbering and Coding for the China Central Depository and Clearing Company, Limited (CCDC)

5.1.1 Securities Numbering

All securities registered on the Inter-bank Bond Market are given an International Securities Identification Number (ISIN). The ISIN is not used for bond trades or settlement, but rather proprietary securities numbering is used. The CCDC is planning to create a conversion table within the system to make possible the conversion of proprietary numbering to ISIN.

5.1.2 Financial Institution Identification

A proprietary participant code is used for financial institution identification. By creating the conversion table in the system, the conversion of proprietary code into the business identifier code (BIC, ISO 9362) is possible.

5.1.3 Securities Account

For securities accounts, the proprietary account code is used instead of ISO 20022.

5.1.4 Cash Account

The proprietary account code is also used for cash accounts instead of the International Bank Account Number (IBAN).

5.1.5 Character Code and Language

Unicode (UTF 8) is used for character codes. For the language code, it is not desirable to use English as a common language, thus, the need to make a standard conversion rule.

5.2 Numbering and Coding for the China Securities Depository and Clearing Corporation (CSDCC)

5.2.1 Securities Numbering

For securities numbering, the local code is still used instead of the ISIN. It is possible to convert local numbering to ISIN using a conversion rule.

5.2.2 Financial Institution Identification

Financial institution identification codes use local codes instead of the ISO 9362 (BIC). A software program is used in converting BIC and local codes.

5.2.3 Securities Account

Local securities account code is used for securities account.

5.2.4 Cash Account

For local accounts, local account code is used instead of the IBAN.

5.2.5 Character Code and Language

Unicode (UTF) is not used as the character set.

6. Medium- to Long-Term Strategy

6.1 CFETS Medium- to Long-Term Strategy

As the main trading platform and the price setting center of RMB products, CFETS will continue to strengthen the construction of infrastructure through promoting debt financing instruments innovation, which is to comply with market demand, going a step further to optimize the market transaction mechanism and service mode, and expanding market participants including continuously introducing foreign institutional investors.

6.2 CCDC Medium- to Long-Term Strategy

CCDC has three major targets to achieve by 2014. First, ensure that its core business, management and systems meet international standards and are fully prepared for the opening up of China's bond market to the world, as well as supporting the RMB bond market's move to become the regional core market. Second, diversify on the basis of professionalization: establishing its strengths while developing its core competencies and new business; protecting against risk and increasing our overall operating capacity. Third, improve its internal management in line with modern financial corporate standards in order to reap both economic and social rewards.

CCDC is trying to enhance its comprehensive issuance services, expanding the coverage and depth of registration and depository services, improving its customer service system, improving IT system construction standards, and promoting strategic research and cooperative exchange.

Cross-border bond-related business will be promoted based on the agreements and Memoranda of Understanding (MOUs) with ICSDs and other CSDs. CCDC shall participate in the International Standardization Organization and shall participate in making the standard rules and promoting related business. Also, CCDC shall consider the situation of each country and each region, and shall support local business as much as possible.

6.3 SHCH Medium- to Long-Term Strategy

Continuous improvement of various aspects of registration, custody, clearing and settlement services, and enhancement of STP processing capabilities would be the core of the Mid- to Long-Term Strategy and Technical System Construction Plan of SHCH. As a clearing institution and CSD, the business area of SHCH includes registration, depository, clearing, settlement and other relevant services of RMB and foreign exchange cash and derivatives.

In terms of registration and depository service, SHCH would improve the efficiency of registration and depository service, as well as reduce the operational risk to meet regulatory requirements. In the aspects of registration, custody, settlement, interest payment, information disclosure, evaluation, collateral management and other information services for innovative, fixed-income and moneymarket instruments, SHCH would enhance the quality of services by an automated and standardized procedure according to relative international standard.

In terms of market services, when broadening the business scope of the CCP clearing and enrich the level and range of clearing members, SHCH would implement the recommended standardized approach, such as BIS and other international standardized institutions. Firstly, it would support and coordinate market regulatory requirement, reform OTC market transactions stratification and settlement agent to improve efficiency and enhance incentive mechanism, by providing relative automotive services. Secondly, it would support multi-product and multi-market to meet the centralized clearing and settlement requirements of OTC market, broaden the service network of clearing members, enhance the data downloading/uploading service via member terminals, and improve the quality of multi-product cross-market clearing and settlement service, to prevent systemic risk.

Appendix 1

People's Bank of China Published Notice on Issues Concerning Renminbi Investments in the Inter-bank Bond Market in the People's Republic of China

The People's Bank of China (PBOC) has published a notice on relevant issues in relation to renminbi investments by three kinds of institutions in the Inter-bank Bond Market in the People's Republic of China on a pilot basis. The Notice has been issued in conjunction with the pilot programme of using renminbi to settle cross-border trades, and is intended to further facilitate and widen the channels for the backflow of offshore renminbi.

Amongst other things, the Notice includes the following provisions:

- The three kinds of competent institutions are offshore central banks or currency authorities (referred to as Offshore Central Banks), renminbi clearing banks in Hong Kong, China and Macau, China (referred to as renminbi Clearing Banks), and offshore participating banks for renminbi settlement of cross-border trades (referred to as Offshore Participating Banks). These three are referred to collectively as Offshore Institutions;
- Renminbi funds that are permitted to invest in the Inter-bank Bond Market shall come from currency cooperation between central banks, cross-border trades and investment in renminbi business;
- Offshore Central Banks and renminbi Clearing Banks may entrust Inter-bank Bond Market settlement agents, which have the capability of conducting international settlement business to trade and settle bonds. They may also apply to open a bonds account with the China Central Depository and Clearing Corporation, Limited directly and complete the relevant procedures with the National Interbank Funding Center;
- Offshore Participating Banks shall entrust Inter-bank Bond Market settlement agents, which have the capability of conducting international settlement business to trade and settle bonds;
- Offshore institutions shall open renminbi special accounts for the funds settlement of bond transactions—each institution is permitted to open only one renminbi special account; and
- Offshore institutions can only make investments within their approved quota, and are not permitted to trade bonds with their affiliate enterprises.

The Notice also applies to other offshore financial institutions that participate in cross-border services settled by renminbi on a pilot basis and use renminbi funds to invest in the Inter-bank Bond Market.

Hong Kong, China (HKG)

1. Bond Market Infrastructure

1.1 Overview of Bond Markets

The Hong Kong bond market is comprised mainly of over-the-counter (OTC) market, while a relatively small portion of bonds are listed and traded on the Hong Kong Stock Exchange.

The Central Moneymarkets Unit (CMU) serves as the central securities depository (CSD) in Hong Kong for debt securities involving Exchange Fund Bills and notes, government bonds, and debt securities issued by both public and private entities. The CMU is owned and operated by the Hong Kong Monetary Authority (HKMA), and also provides trade matching and bond settlement service for market participants. It also conducts end-of-day batch settlement on net basis, but does not act as a Central CounterParty (CCP).

Cash settlement is performed on the Clearing House Automated Transfer System (CHATS), a computer-based system in Hong Kong for electronic processing and settlement of interbank fund transfers. CHATS operates in a Real Time Gross Settlement (RTGS) mode between banks in Hong Kong, and is designed for large-value interbank payments. Banks using CHATS are connected to the clearing house computer operated by the Hong Kong Interbank Clearing Limited (HKICL). The HKMA, Hongkong and Shanghai Banking Corporation Limited (HSBC), Standard Chartered Bank (Hong Kong) Limited, and Bank of China (Hong Kong) Limited, respectively, serve as the Settlement Institution for the HKD, USD, EUR, and RMB RTGS systems under CHATS.

Please refer to Figure HK01 of Part 3: Diagram of Hong Kong, China Bond Markets.

1.2 Description of Related Organizations

The Hong Kong Monetary Authority (HKMA)

The HKMA was established on 1 April 1993 after the Legislative Council passed amendments to the *Exchange Fund Ordinance* in 1992 empowering the Financial Secretary to appoint a Monetary Authority. The powers, functions, and responsibilities

of the Monetary Authority are set out in the *Exchange Fund Ordinance*, the *Banking Ordinance*, the *Deposit Protection Scheme Ordinance*, the *Clearing and Settlement Systems Ordinance* and other relevant Ordinances. The division of functions and responsibilities in monetary and financial affairs between the Financial Secretary and the Monetary Authority is set out in an “Exchange of Letters” between them dated 25 June 2003. This Exchange of Letters also discloses the delegations made by the Financial Secretary to the Monetary Authority under these Ordinances.

The HKMA’s main functions are:

- to maintain currency stability within the framework of the Linked Exchange Rate system;
- to promote the stability and integrity of the financial system, including the banking system;
- to help maintain Hong Kong’s status as an international financial center, including the maintenance and development of Hong Kong’s financial infrastructure; and
- to manage the exchange fund.

The HKMA is an integral part of the Hong Kong government. In its day-to-day work, the HKMA operates with a high degree of autonomy within the relevant statutory powers conferred upon, or delegated to, the Monetary Authority.

Hong Kong Interbank Clearing Limited (HKICL)

HKICL is a private company jointly owned by the HKMA and the Hong Kong Association of Banks (HKAB). HKICL was established in May 1995 to take over in phases the clearing functions provided by the former management bank of the Clearing House. The Hongkong and Shanghai Banking Corporation Limited (HSBC), and the process was completed in April 1997.

HKICL provides interbank clearing and settlement services to all banks in Hong Kong, and operates a central clearing and settlement system for public and private debt securities on behalf of the HKMA.

1.3 Trading

1.3.1 Over-the-Counter Market

Bonds in Hong Kong are primarily unlisted and traded over-the-counter (OTC).

1.4 CCP (Central Counterparty Clearing)

There is no CCP for the bond market in Hong Kong.

1.5 Bond Settlement

In Hong Kong, majority of bond transactions are conducted OTC, and cleared and settled through the CMU. The Settlement of bond transactions through the CMU is final and irrevocable. This finality is protected from insolvency laws and other laws by the Clearing and Settlement Systems Ordinance (CSSO).

The CMU is the debt securities clearing and settlement system in Hong Kong operated by the HKMA. Established in 1990, the CMU provides an efficient clearing,

settlement and custodian service for debt securities denominated in Hong Kong dollars and other major currencies. It also provides an electronic book-entry system, which eliminates the physical delivery of debt securities between CMU members. These debt securities include Exchange Fund papers, Government bonds, and debt securities issued by both public and private sector entities.

In December 1996, a seamless interface between the CMU and HKD RTGS system was established. Such linkage provides real-time and end-of-day delivery versus payment (DVP) services to CMU members. The CMU was further linked to the USD, euro, and RMB RTGS systems in December 2000, April 2003, and March 2006, respectively, to provide real-time DVP capability for debt securities denominated in these currencies, and also intraday and overnight repo facilities for their respective payment systems in Hong Kong.

Through the seamless interface between the CMU and the HKD, USD, EUR, and RMB RTGS systems, securities transactions can be settled on real-time or end-of-day DVP basis in the CMU. For real-time DVP, both seller and buyer input instructions through its CMU Terminal or SWIFT. Once the instruction is matched, the 'matched' transaction will be stored in the system. The system will then look for the specific securities in the seller's account and put the securities on hold, after which an interbank payment message will be generated. After the payment initiated by the buyer is settled across the books of the HKMA or the Settlement Institution (SI), a confirmed message will be returned to the CMU and the securities held will be released to the buyer. If the seller does not have sufficient securities, the system will retry at a 15 minutes' interval until cut-off time by which all unsettled transactions are converted to end-of-day transactions and settled during the end-of-day settlement run. Likewise, if the buyer does not have sufficient funds in its cash accounts, the transactions are pending for settlement until sufficient funds are available in the buyer's accounts. If transactions cannot be settled before the cut-off time, the transactions are converted to end-of-day transactions and settled during the end-of-day settlement run.

For end-of-day transactions, securities and cash are settled on multilateral netting basis. At the settlement time of end-of-day settlement run, the system calculates the net settlement amount of both securities and cash for each member. The system will then check whether sufficient funds and securities are available for each member. If so, final transfers of both securities and cash for all members are effected simultaneously. Otherwise, all or part of transfer instructions of the members who do not have sufficient funds or securities will be cancelled before final end-of-day settlement takes place.

The settlement of government bond is performed on the CMU's book-entry system. CMU supports both real-time gross settlement (BIS Model 1) and end-of-day net settlement (BIS Model 3). Presently, over 90% of trades are settled on DVP basis. In terms of settlement arrangements, if the debt securities are settled using real-time DVP mode, both cash and securities legs are settled on gross basis. If the debt securities are settled using end-of-day DVP mode, both cash and securities are settled on net basis. If the securities are settled using free of payment (FOP) mode, settlement will be done in gross basis for real-time FOP or net basis for end-of-day FOP.

The settlement process for government bond trades (DVP) is illustrated as follows.

Figure 2.1 Settlement Process for Government Bond Trades

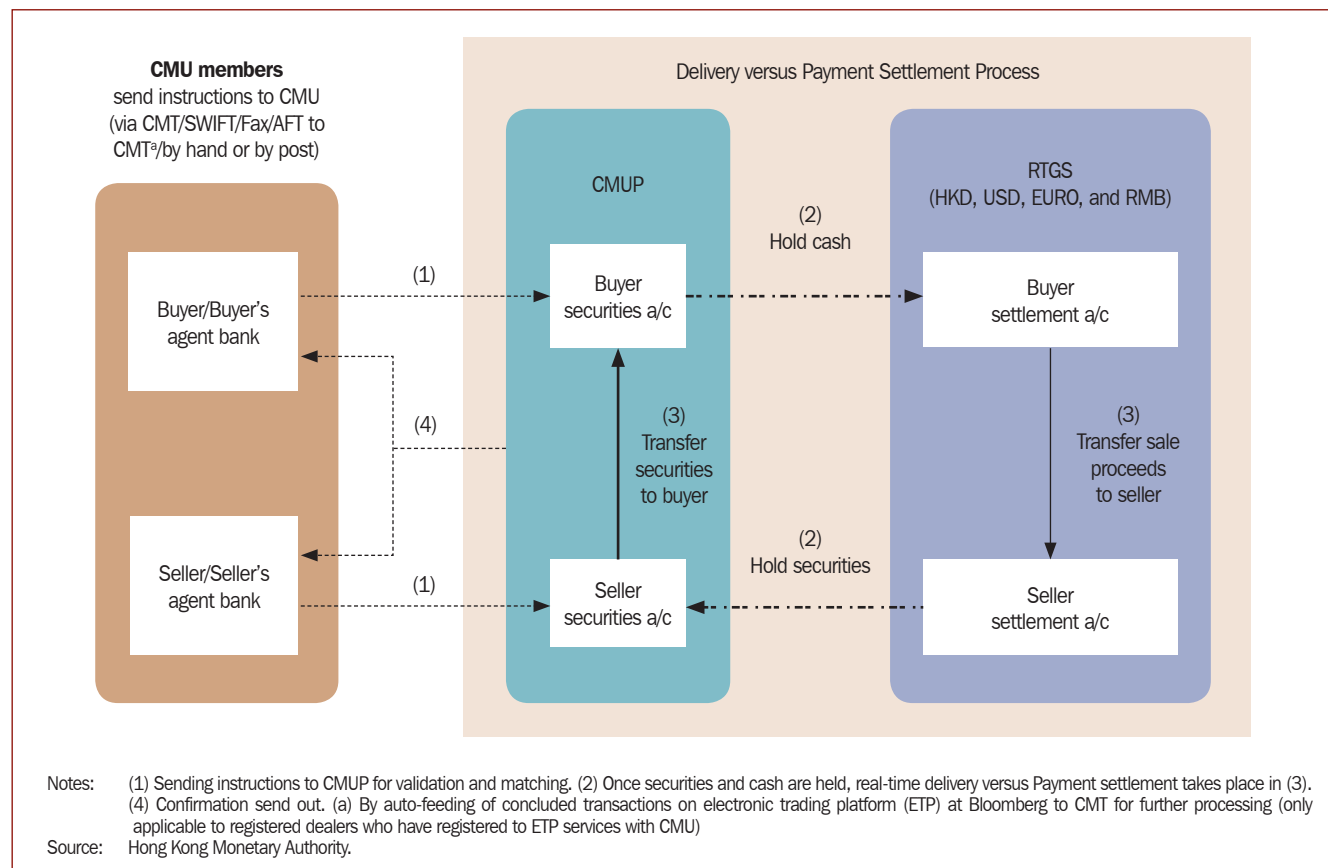

CMU uses SWIFTNet as its network with participants. Types of lines are leased line and internet. Protocol is TCP/IP. Interfaces are SWIFTNet InterAct and InterBrowse. Message format is ISO15022.

Over the years, CMU has developed external links with regional CSDs and ICSDs. One-way inbound links from Euroclear and Clearstream, the two largest ICSDs in the world, to CMU were set up in 1994 to allow international investors to hold and settle Hong Kong dollar debt securities through these international networks. The linkages were further extended to two-way (bilateral) links in November 2002 (Euroclear) and January 2003 (Clearstream) to enable investors in Hong Kong and other parts of Asia to hold and settle Euroclear and Clearstream debt securities directly in a secure DVP environment via their CMU members.

Hong Kong's multi-currency payment and securities settlement infrastructure is illustrated as follows.

Figure 2.2 Hong Kong Multi-Currency Payment and Securities Settlement Infrastructure

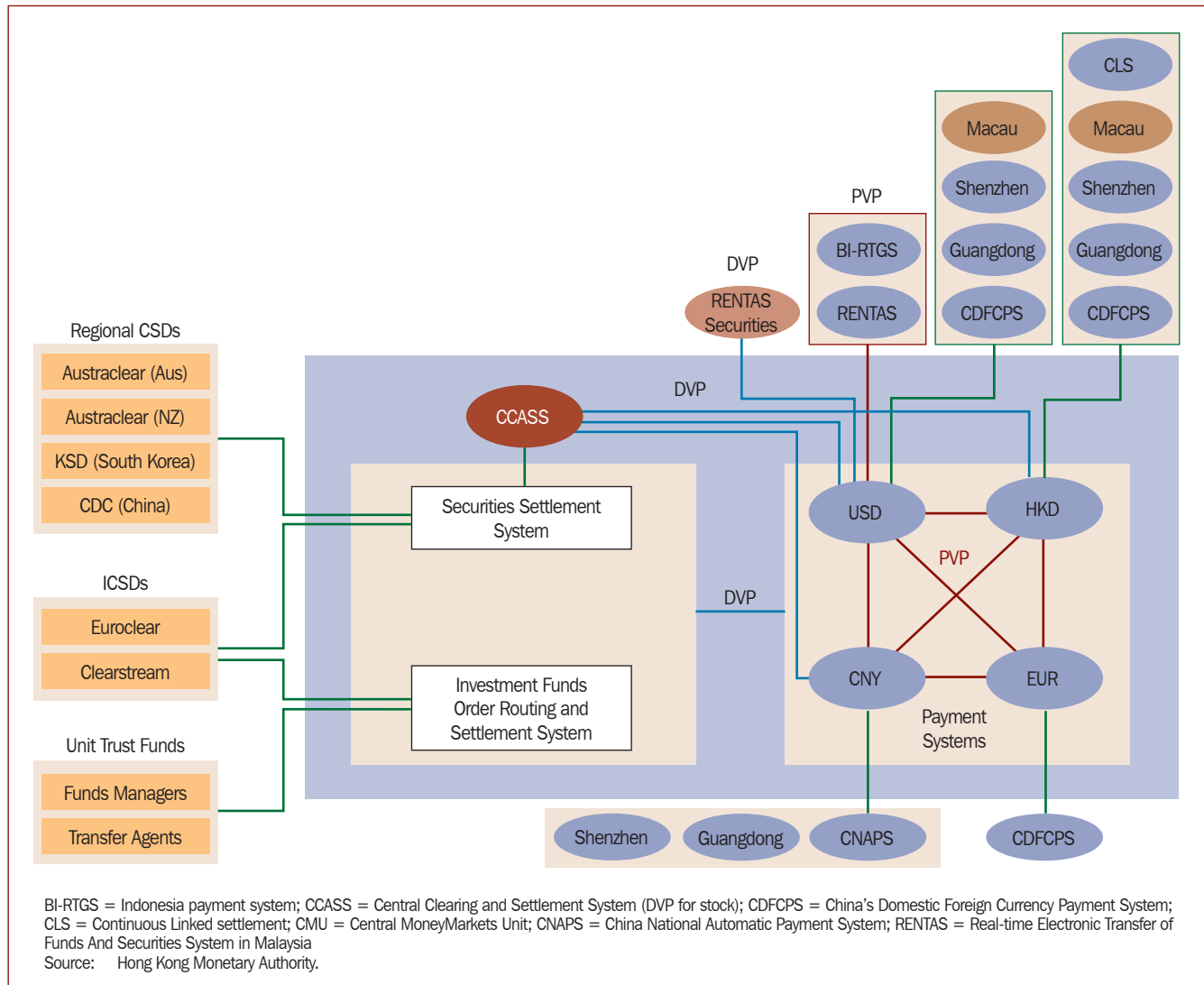

CMU also established links with CDSs in Australia in December 1997, New Zealand in April 1998, and South Korea in September 1999. Apart from facilitating cross-border holding and settlement of debt securities in Hong Kong and overseas, they also enlarged the investor base, broadened the domestic debt markets, and reduced settlement risk by facilitating DVP settlement for cross-border securities transactions. HKMA and the China Central Depository and Clearing Co., Ltd. (CCDC) signed an agreement in April 2004 to establish a link between CMU and the Government Securities Book-entry System (GSBS) operated by the CCDC. This link enables authorised investors in Mainland China to hold and settle Hong Kong and foreign debt securities lodged in CMU. These links for Euroclear, Clearstream, New Zealand, and South Korea are bilateral. The others (for China and Australia) are unilateral. To be concrete, CMU has an account at Austraclear in Australia, and CCDC has an account at CMU.

The cross-border and cross currency trade is processed along the model that the following figures show.

Figure 2.3 Cross-Border Cross-Currency Delivery-versus-Payment Model for Renminbi-Denominated Debt Securities Issued in Hong Kong, China

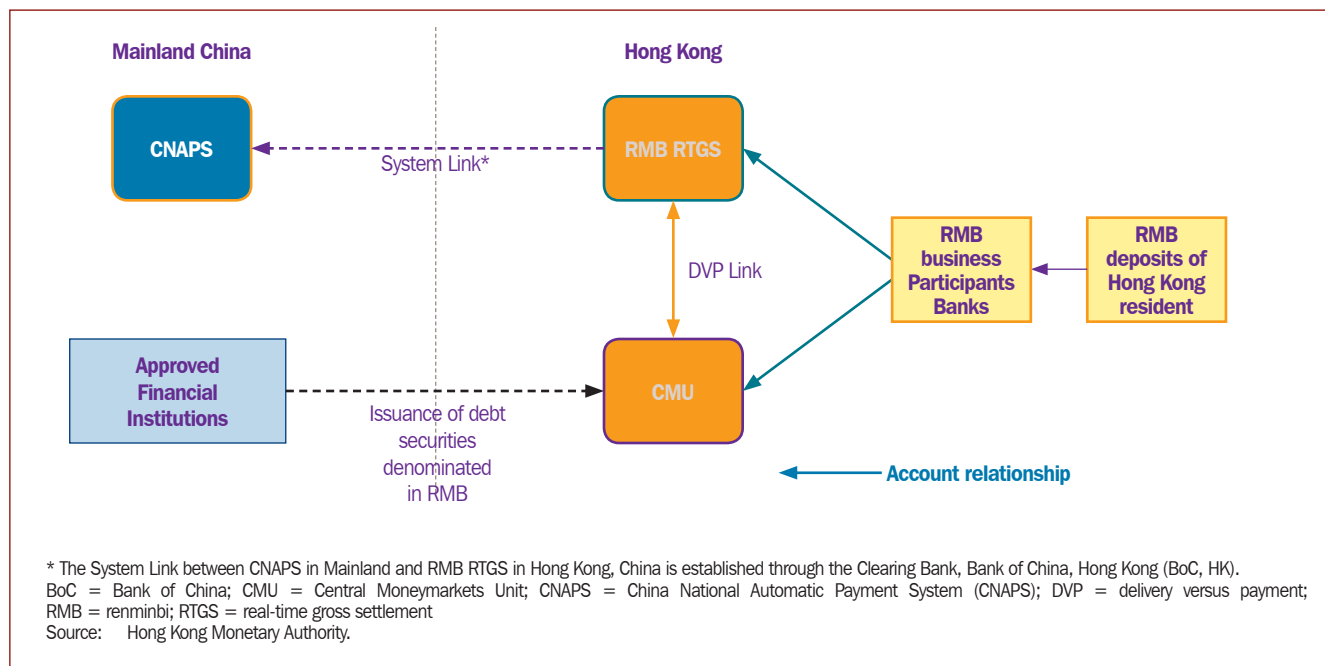

Cross-border cross-currency DVP Model (denominated in USD) is illustrated as follows.

Figure 2.4 Cross-Border Cross-Currency Delivery-versus-Payment Model

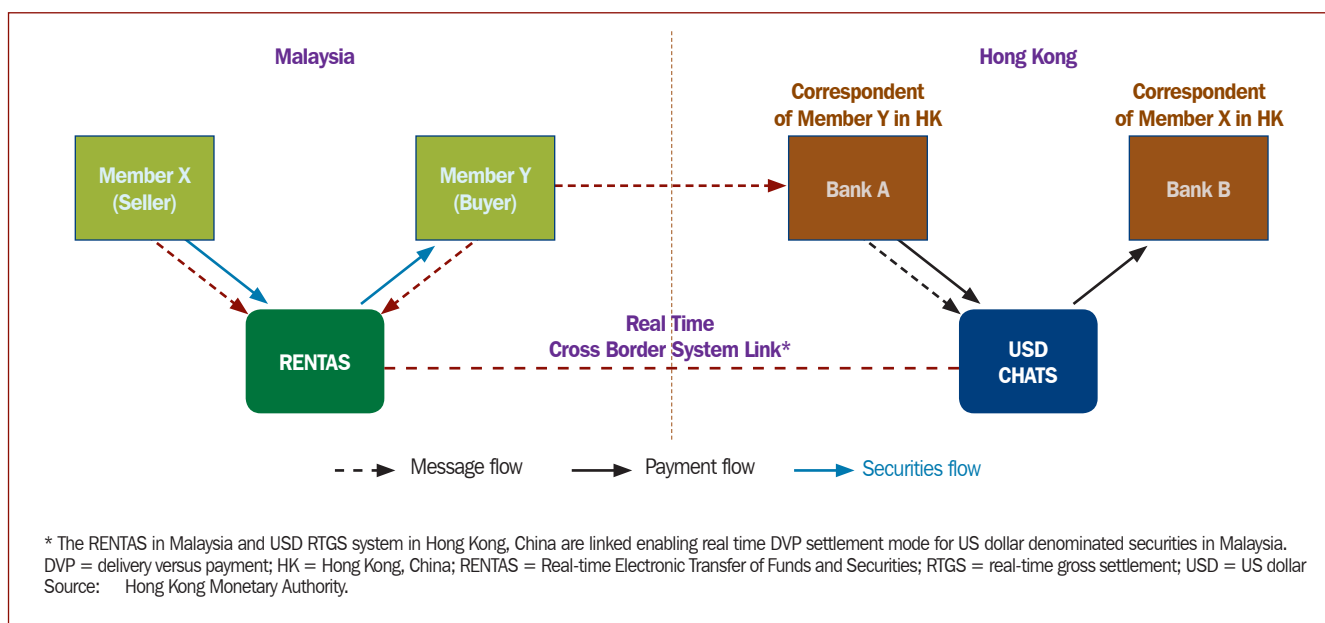

1.6 Cash Settlement

Cash settlement of bond transactions is carried out in CHATS. As mentioned in the section on bond settlement section above, for real-time DVP transactions, after the CMU put the required securities involved in a bond transaction in the seller's account on hold, an interbank payment message will be generated in CHATS. After the payment initiated by the buyer is settled across the books of the HKMA or the relevant Settlement Institution (SI), a confirmed message will be returned to the CMU and the securities held will be released to the buyer. If the buyer does not have sufficient funds in its cash accounts, the transactions will be pending for settlement until sufficient funds are available. In the event that the transaction cannot be settled before the cut-off time, the transaction will be converted to end-of-day transaction and settled during the end-of-day settlement run.

At the settlement time of end-of-day settlement run, the system calculates the net settlement amount of both securities and cash for each member. The system will then check whether sufficient funds and securities are available for each member. If so, final transfers of cash within CHATS and for securities are effected simultaneously. Otherwise, all or part of transfer instructions of the members who do not have sufficient funds or securities will be cancelled before final end-of-day settlement takes place.

To allow better liquidity management for banks via collateral management services, intraday repos and overnight repos are available for HKD, USD, EUR, and RMB RTGS systems while intraday overdraft is available for USD and EUR RTGS systems.⁴

Clearing House Automated Transfer System (CHATS) is a computer-based system established in Hong Kong for the electronic processing and settlement of interbank fund transfers. CHATS operates in a Real Time Gross Settlement (RTGS) mode between banks in Hong Kong and is designed for large-value interbank payments. Banks using CHATS are connected to the clearing house computer operated by the Hong Kong Interbank Clearing Limited (HKICL).

2. Typical Business Flows

2.1 DVP flow for OTC market

Please refer to Figure HK02 of Part 3: Business Process Flowchart of Hong Kong, China OTC market.

2.2 Cross-Border Flow

Please refer to Figure HK03 of Part 3: OTC Bond Transaction Flow for Foreign Investors (including cross-border, funding components).

3. Matching

3.1 OTC market

Pre-matching (including linkage transactions) is not a guarantee of settlement and does not commit either party to settlement. All FOP and DVP instructions,

⁴ Intraday and overnight repos for RMB RTGS system were introduced on 21 February 2011.

except house transfer between participants own accounts, are required to undergo a matching process. Matching fields are at account level. DVP instructions have a settlement amount tolerance level of HKD10.

Both local matching and central matching are supported in Hong Kong, China. Local matching may save time and workload of input but may take the risk to accept incorrect materials input by the input party; central matching need more time for transaction entry and matching but can help identify trading errors more easily.

4. Settlement Cycle

CMU performs clearing and settlement for a variety of debt securities. The settlement cycle of each type of debt securities generally follows the standard cycle practice of that specific type of securities, and may differ among different types of debt securities. For example, the settlement cycles for Exchange Fund papers traded before and after 11 a.m. Hong Kong, China time are T+0 and T+1 respectively. The settlement cycle for Hong Kong government bonds is usually T+1 or T+2, while for corporate bonds and RMB bonds this is typically on T+2 basis.

5. Numbering and Coding

5.1 Numbering and Coding for OTC Market

5.1.1 Securities Numbering

The International Securities Identification Number (ISIN) is used for all securities numbering of bond transactions. The CMU system also supports the CMU Issue Number (i.e., local code) and Common Code.

5.1.2 Financial Institution Identification

A CMU Member Account Number is assigned by internal coding scheme in the CMU. There is no need to convert between ISO 9362 (BIC) and local codes because the system database can include both BIC and local codes.

5.1.3 Securities Account

ISO 20022 is not used for securities account. It is identified by proprietary coding scheme.

5.1.4 Cash Account

The International Bank Account Number (IBAN) code is not used for cash account. It is identified by the CMU member code (proprietary).

5.1.5 Character Code and Language

A character set supported by SWIFT is used for coding and language.

6. Medium- to Long-Term Strategies

In terms of official initiatives to promote Straight through processing (STP) of bond trading, the HKMA encourages participants to trade Exchange Fund papers using the electronic platform. In particular, STP is promoted through FOP and DVP settlement for debt securities.

The biggest challenge for market members when it comes to STP involves the processing of cross-border transactions.

A Task Force comprising the HKMA, a group of central banks and central securities depositories (CSDs) in the Asian region, and Euroclear issued a White Paper in June 2010, recommending the development of a Common Platform Model in the long run to improve the cross-border post-trade clearing and settlement infrastructure for debt securities in Asia. One major objective of the Common Platform Model in vision is to introduce common systems and processes as well as common securities and corporate action database across markets in Asia to promote efficiency.

The conceptual framework of the Common Platform Model is illustrated as follows.

Figure 2.5 Conceptual Framework of the Common Platform Model

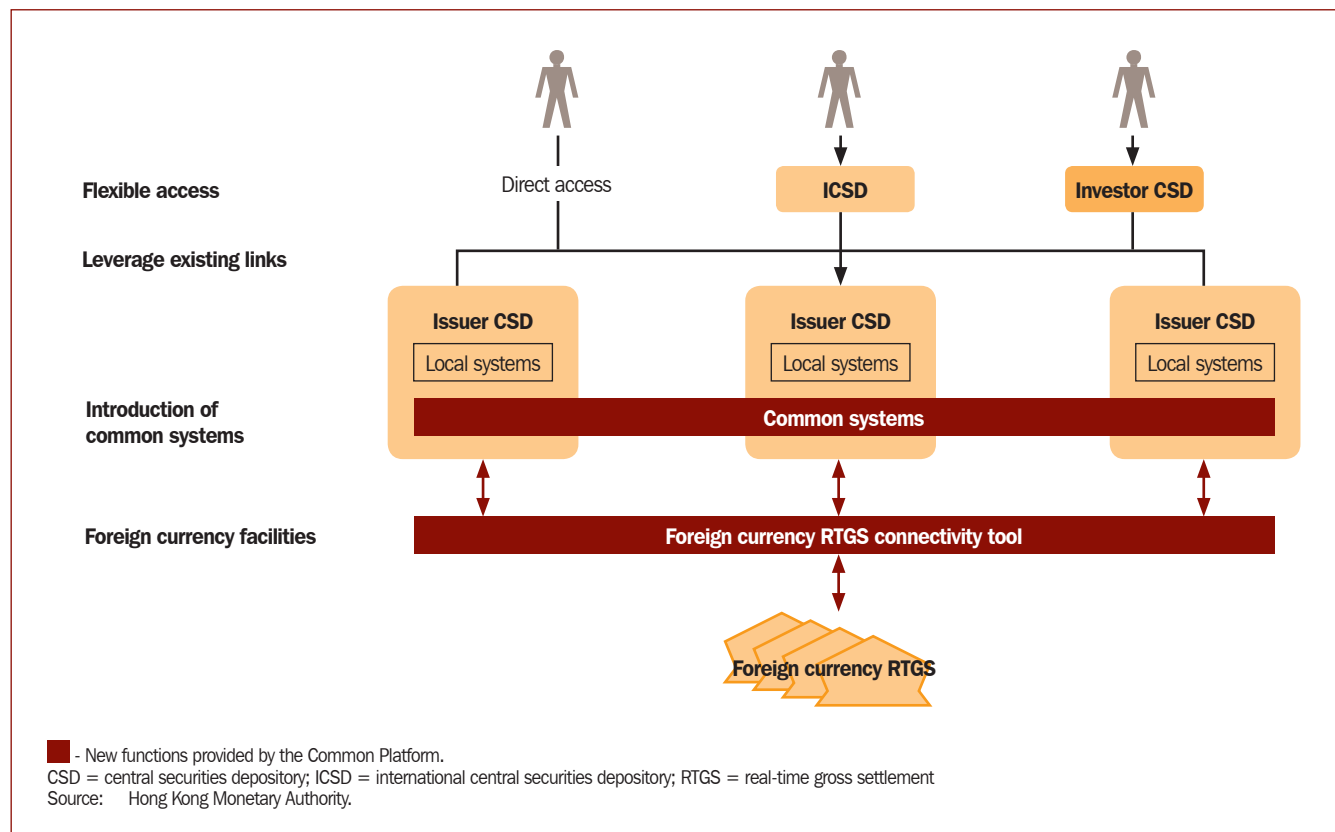

Since it will take time and effort to introduce harmonized processes and common systems in Asia, the Task Force agreed to adopt a gradual approach and introduce the Pilot Platform as a tactical solution to deliver early benefits of the Common Platform

Model before its full implementation. The main objective of the Pilot Platform is to ensure that developments and changes in local practices, regulations and laws are kept at a minimal level, and that the Pilot Platform can bring in come quick wins with limited upfront investments and risks. The HKMA, together with Bank Negara Malaysia and Euroclear, will join the Pilot Platform as early movers. The Pilot Platform is expected to be launched in early 2012; currently, deliberation work is being conducted on possible add-on services (e.g., cross-border collateral management and corporate action servicing) to be provided following the launch of the Pilot Platform.⁵

Concept of the Pilot Platform is illustrated below.

Figure 2.6 Conceptual Framework of the Pilot Platform

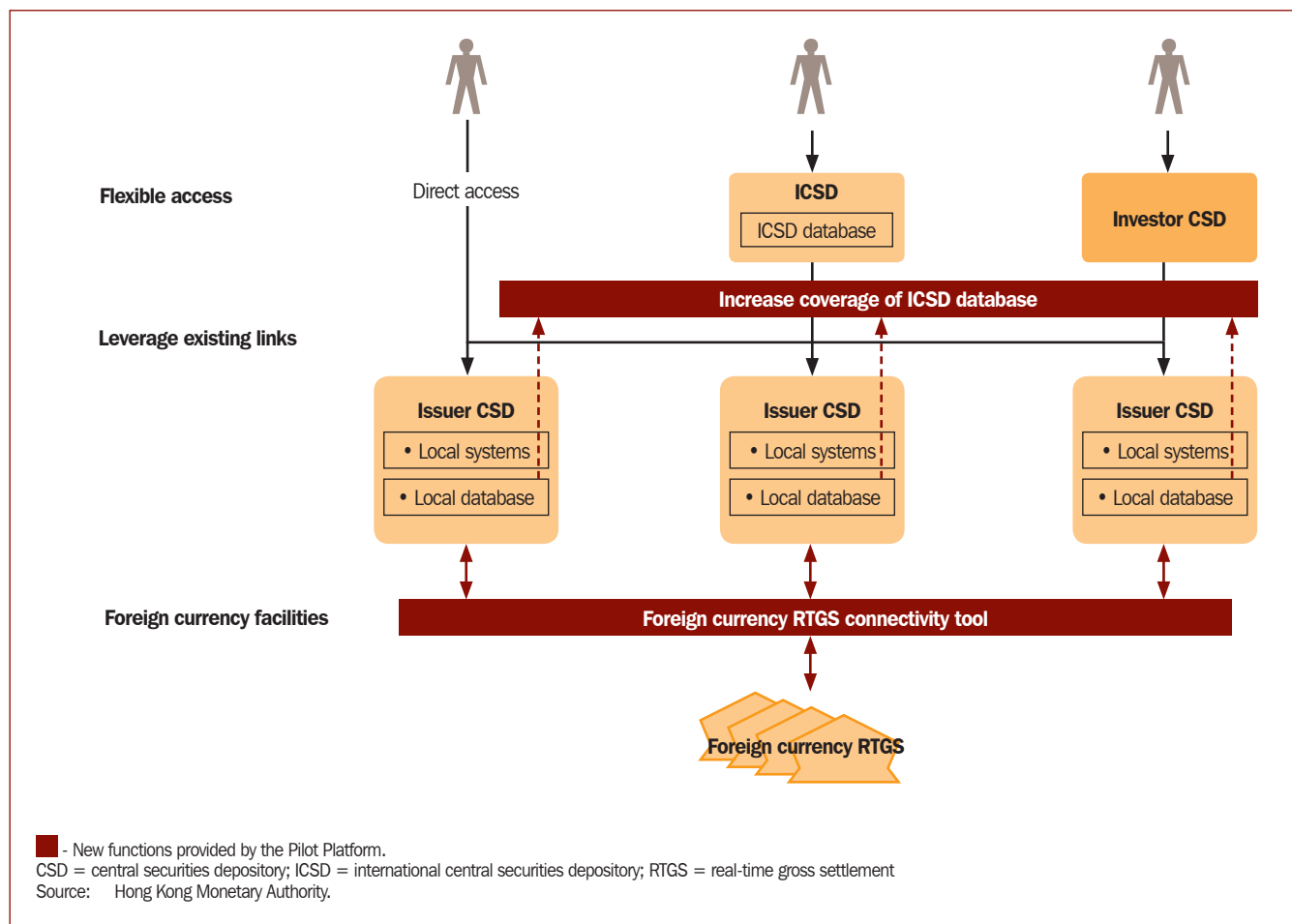

⁵ Hong Kong Monetary Authority. 2010. *Common Platform Model for Asia: A Collaborative Effort to Improve the Post-Trade Processing Infrastructure for Debt Securities in Asia*. <http://www.info.gov.hk/hkma/eng/public/qb201009/fa2.pdf>; *Common Platform Model for Asian Post-trade Processing Infrastructure White Paper*. http://www.info.gov.hk/hkma/eng/infra/pan_asian/white_paper.pdf

Indonesia (INO)

1. Bond Market Infrastructure

1.1 Overview of Bond Markets

The Indonesian bond market is comprised of the over-the-counter (OTC) and exchange markets. Government bonds are traded OTC, whereas corporate bonds are listed and traded on the Indonesia Stock Exchange (IDX). Corporate bonds can also be traded at the exchange using the Fixed Income Trading System (FITS). However, bond trading at the exchange is not popular, and almost all bonds—either government or corporate bonds—are traded in the OTC market. There are two central depositories handling bonds; Bank Indonesia (BI) handles government bonds, and the Indonesian Central Securities Depository (KSEI) handles corporate bonds, as well as government bonds (as a subregistry to BI). Settlement of the government bonds is performed on Bank Indonesia–Scripless Securities Settlement System (BI-SSSS). Cash settlement of government bonds is conducted on Bank Indonesia Real-time Gross Settlement (BI-RTGS). BI-SSSS and BI-RTGS are electronically linked on Bank Indonesia Real-time Gross Settlement (BI-RTGS). BI-SSSS and BI-RTGS are electronically linked. The settlement of government and corporate bonds in KSEI is performed in the Central Depository and Book Entry Settlement (C-BEST) system, with cash settlement conducted via the appointed payment banks. There is no clearing system on the OTC market.

On the other hand, for corporate bonds are traded in IDX using the FITS, the settlement is handled by KSEI with payments through the appointed payment banks. After trade matching, clearing is conducted on the Electronic Bond Clearing System (e-BOCS) and trade settlement is performed on the Central Depository and Book Entry Settlement (C-BEST). The e-BOCS system is operated by Indonesia Clearing and Guarantee Corporation (KPEI), while the C-BEST system is operated by KSEI. Cash settlement is conducted by five appointed payment banks.

The market infrastructure diagram is shown in Part 3, Figure C.1.

1.2 Description of Related Organizations

The Indonesia Stock Exchange (IDX)

IDX is a private-owned limited company, whose shareholders are local stock-broking firms. IDX is the stock exchange in Indonesia and came into existence as a

mandate of Indonesian Capital Market and Financial Institution Supervisory Agency (BAPEPAM-LK) “Capital Market Master Plan 2005–2009,” which stipulated the merger of Jakarta Stock Exchange (JSX) and Surabaya Stock Exchange (SSX).

The Indonesian Clearing and Guarantee Corporation (KPEI)

KPEI, Indonesia’s central counterparty (CCP), was established in 1996 as a limited company to provide clearing and settlement, guarantee services for stock exchange transactions (equity, bonds and derivatives), and provide securities and borrowing.

Bank Indonesia (BI)

BI is the central bank of the Republic of Indonesia. BI acts as the central depository for the settlement and safekeeping of government bonds. Its role as the central registry of government bonds includes that of a registrar, settlement agent, and paying agent for coupon, interests and principal.

PT Kustodian Sentral Efek Indonesia (KSEI)

KSEI was granted a permanent operational license as a depository and settlement institution by the BAPEPAM-LK on 11 November 1998. KSEI’s shareholders consist of the IDX, KPEI, custodian banks, securities companies, and registrars. KSEI started the settlement operations in scripless form beginning July 2000. Participants in the KSEI are custodian banks, securities companies and other parties approved by Bapepam-LK.

1.3 Trading

1.3.1 Over-the-Counter Markets

There is no formal OTC market in the Indonesian bond market; however, all government bonds can be traded off-exchange and traded directly between counterparties. Although all government bonds and corporate bonds are automatically listed on the IDX, most of trading is done OTC, and they must be reported to the exchange through their system called Centralized Trading platform (CTP) within 30 minutes after a trade is executed. The OTC market occupies a dominant position of bond trading (100%).

The centralized trading platform (CTP) is an electronic system established to facilitate the reporting of bond transactions. This system was introduced in September 2006 following the appointment of SSX as the Bond Transaction Reporting Center. Users of the CTP are securities companies and banks, which are obliged to report all their corporate and government bond transactions, as well as the transaction of their clients. After the merger, IDX takes over this role from SSX.

1.3.2 Exchange Markets

In June 2005, the stock exchange introduced FITS to facilitate the trading of bonds in the exchange. Bond trades in the exchange are handled through the e-BOCS, including allocations.

IDX provides Exchange Trade and OTC reporting as follows.

- **Bonds Exchange Trading System;**

Investor can order and trade bonds in this system via exchange member (currently only Securities Company) though there was no transaction in Bonds Exchange

Trading System in 2011.

• **Bonds Transaction Reporting System;**

IDX has been appointed by Bapepam-LK and Indonesia SEC, as the Bonds Transaction Reporting Beneficiary, since 2006. Market player reports their OTC transaction to this system via banks and securities company. Market player have obligation to report these transaction to Bapepam-LK through Bonds Transaction Reporting System within 30 minutes.

Both systems can be used for government and corporate bonds.

Figure 3.1 Secondary Market Flow

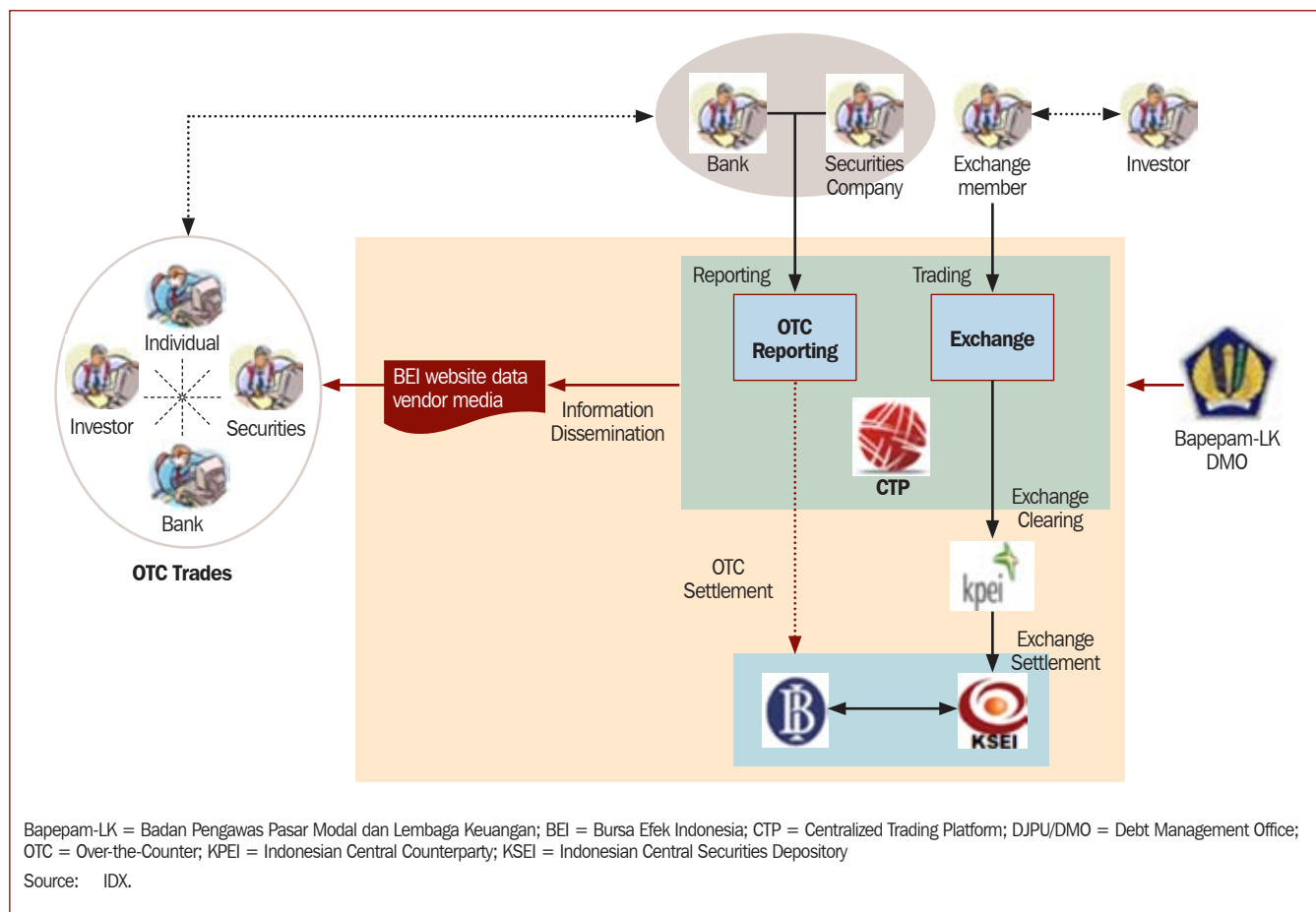

1.4 Central Counterparty Clearing

1.4.1 Central Counterparty Clearing for the Over-the-Counter Market

There is no clearing system on the OTC market.

1.4.2 Central Counterparty Clearing for the Exchange Market

The KPEI has operated e-BOCS since 2006. e-BOCS is the system to settle all bond transactions executive in the IDX. This clearing mechanism shortens the settlement of bonds obligations and also increases efficiency of settlement.

1.5 Bond Settlement

1.5.1 Bond Settlement Traded at Bank Indonesia–Scripless Securities Settlement System

For government bonds, BI is currently appointed as the central registry to handle government bonds, while KSEI and other custodians are sub-registries under BI. Currently, BI maintains only one omnibus account for each sub-registry. Brokers and some custodians, which are not sub-registries of BI, settle and deposit their government bonds to KSEI as the central depository. The registry system of Indonesian government bonds is illustrated as follows.

Figure 3.2 Registry System of Indonesian Government Bonds

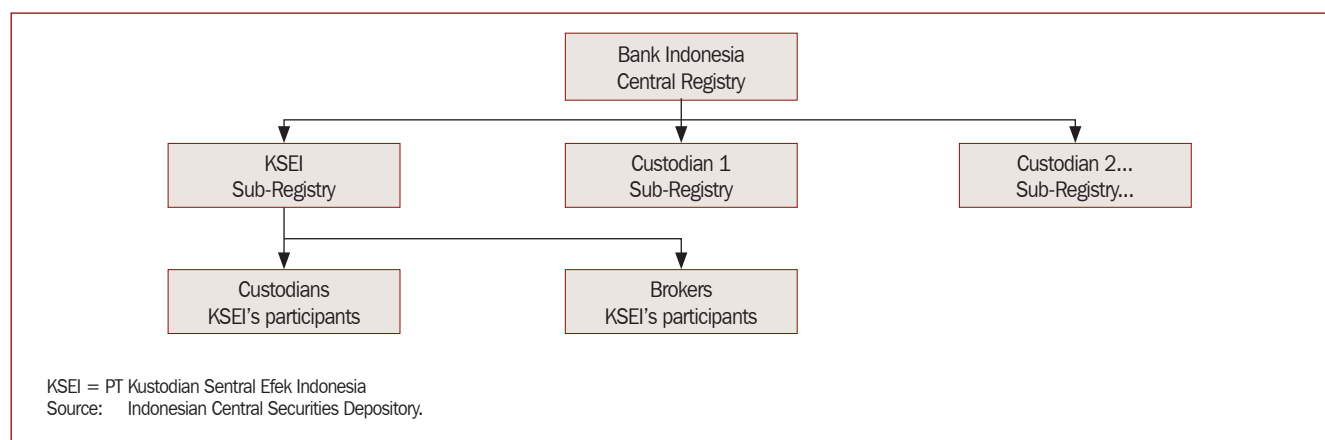

Settlement of government bonds is through BI-SSSS, which has been implemented since 16 February 2004. Under BI-SSSS, settlement of government bonds can only be performed on delivery-versus-payment (DVP) basis. This means that government bonds are not allowed to be settled on a free-of-payment (FOP) basis, unless it is a transfer for the same beneficial owner, grant, settlement of court, and lending and borrowing. BI-SSSS adopts DVP Model 1 of the Bank for International Settlement (BIS) models.

BI-SSSS's network is a proprietary network. The types of lines are leased line and dial-up. Its protocol is Systems Network Architecture (SNA) while its interfaces are proprietary (file transfer protocol [FTP]) and socket. The message format is proprietary.

1.5.2 Bond Settlement Traded at Central Depository and Book-Entry Settlement

The settlement of corporate bonds is performed on KSEI's C-BEST. C-BEST enables the settlement of government bonds for all market players who have a security account in KSEI but are not sub-registries of BI-SSSS. There is no different procedure for trading government bonds on the exchange market and OTC. KSEI participants have access only to C-BEST but C-BEST is directly connected to BI-SSSS, and automatically delivers or receives messages concerning settlement processes in BI-SSSS; therefore, participants of KSEI can monitor transaction status, balance position, and obtain reports with C-BEST. Transaction status in C-BEST is available for viewing and may be downloaded every 15 minutes. C-BEST adopts DVP Model 2 of the BIS settlement models. Government bonds settlement between BI-SSSS and C-BEST is illustrated as follows.

Figure 3.3 Government Bonds Settlement between BI-SSSS and C-BEST

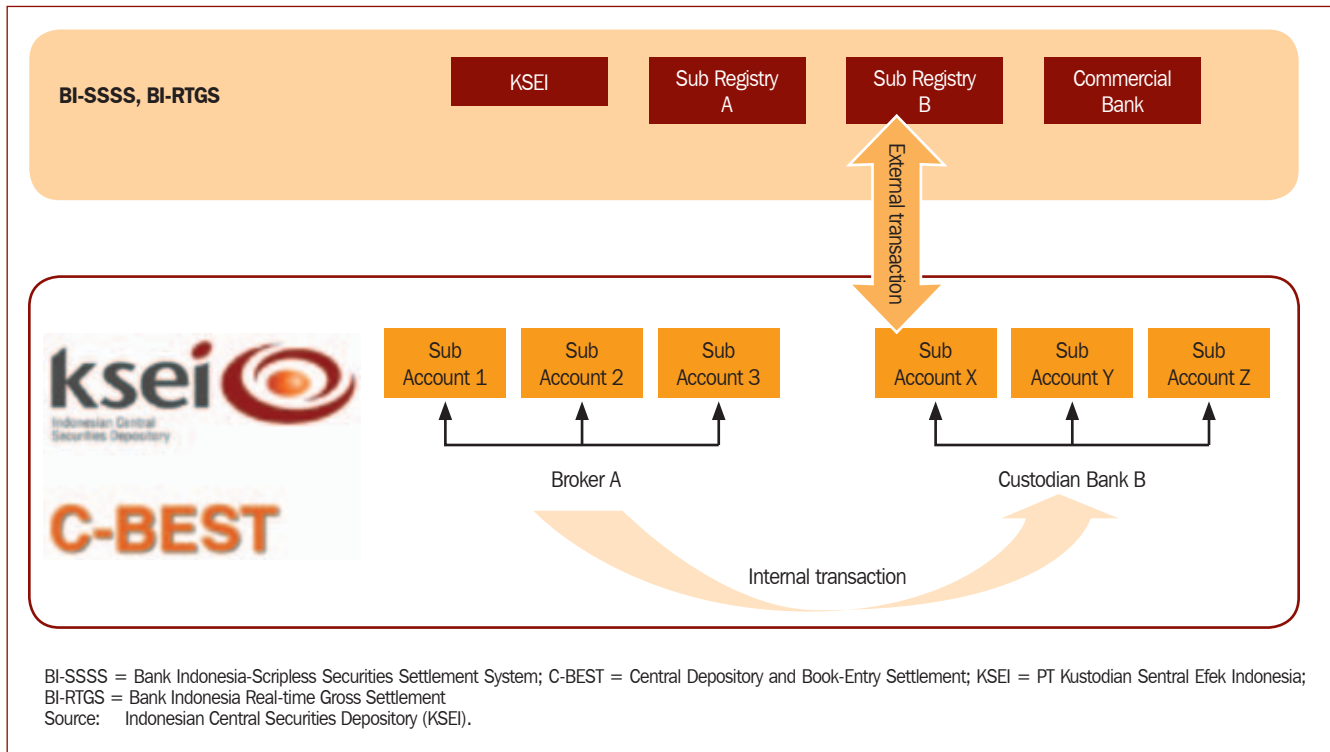

1.6 Cash Settlement

Participants in the BI-SSSS utilize central bank money for bond settlement. BI-SSSS and BI-RTGS owned by BI are directly connected to execute DVP settlement. Overdraft is not permitted for foreigners.

Participants in the KSEI, on the other hand, utilize commercial bank money. KSEI have appointed four cash settlement banks: PT Bank Mandiri Tbk (BMRI), PT Bank CIMB Niaga Tbk (BNGA), PT Bank Central Asia Tbk (BBCA), and PT Bank Permata Tbk (BNLI). Overdraft is not permitted for foreigners, but intraday facility is allowed provided the intraday is supported with a proof of incoming funds or delivery settlement instruction. Custodians provide intraday facility to their selected clients for settlement purposes.

2. Typical Business Flows

2.1 Delivery-Versus-Payment Flow for the Over-the-Counter Market

Part 3, Figure C.2 illustrates the bond transaction flow for domestic trades (OTC market and DVP).

2.2 Delivery-Versus-Payment Flow for Cross-Border Bond Transactions

Bond transaction flow for foreign investors in the OTC market (DVP) is illustrated in Part 3, Figure C.3.

3. Matching

BI-SSSS provides central matching as settlement matching for bond transactions traded on the OTC market. The seller enters the DVP instruction as bond settlement instruction and the buyer enters the receive-versus-payment (RVP) instruction to BI-SSSS. BI-SSSS then compares the DVP and RVP instructions. When the message items of the instructions are completely the same, the status is regarded as matched. If there is discrepancy between the instructions, the status is regarded as mismatched. If one of the instructions is not yet entered, the status is regarded as unmatched.

4. Settlement Cycle

There is no fixed settlement period for bonds in the OTC market. The settlement date is usually negotiated and agreed at the time of the deal by the trading counterparties, and is generally T+2 or T+3. Market participants may discuss the shortening of the settlement cycle.

5. Numbering and Coding

5.1 Numbering and Coding for the Over-the-Counter Market

5.1.1 Securities Numbering

Local code is commonly used in the local market other than the International Securities Identification Number (ISIN) code.

5.1.2 Financial Institution Identification

A local code is used for foreign institution identification.

5.1.3 Securities Account

Local securities account numbering is used.

5.1.4 Cash Account

Local cash account numbering is used.

5.1.5 Character Code and Language

UTF-8 is used for BI-SSSS, C-BEST and BI-RTGS.

6. Medium- to Long-Term Strategies

BI as the central registry for government bonds maintains an electronic registration. Therefore, the settlement processes of government bonds are STP. One of the current challenges in the Indonesian bond market is how to encourage market participants to use a centralized platform for bond trading.

Regarding new initiatives, firstly, BI plans to implement a second-generation system, which will replace the existing model that includes BI-SSSS and BI-RTGS. It will consist

of two systems—the trading system and settlement system. The second-generation model system will be implemented in 2012. Figure 3.4 illustrates the comparison between the existing system and the proposed second-generation system.

Enhancing interoperability between BI-SSSS and C-BEST is another initiative being undertaken by the BI. Particularly, emphasis is placed issues of interface, standardization (e.g., ISIN), tier system, single investor identity, and synchronization.

Figure 3.4 Comparison between the Existing System and the Second-Generation System

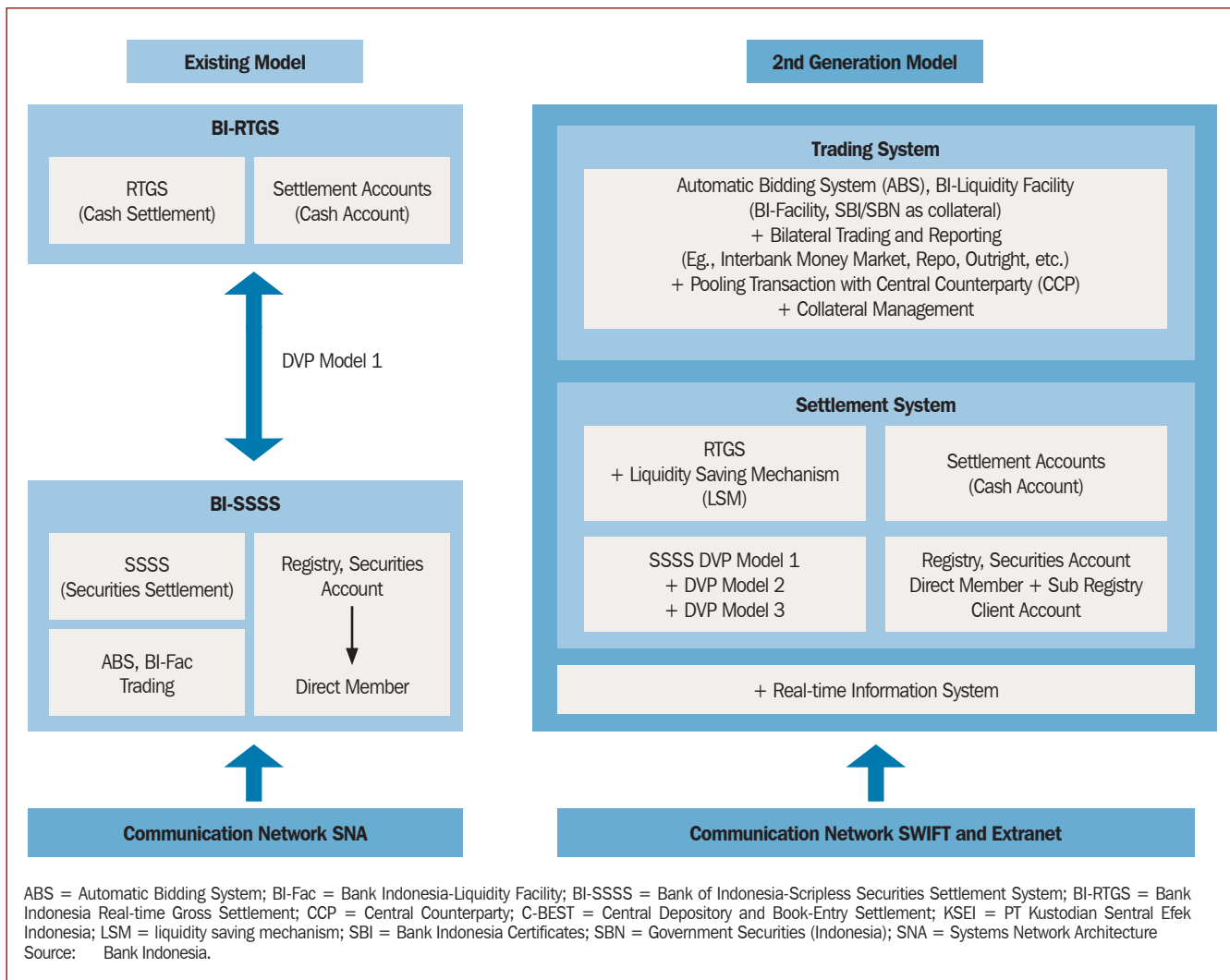

The road map to implement the second-generation system is as follows.

Table 3.1 Road Map for the Implementation of Second-Generation System

Year	Activities
2008	<ul style="list-style-type: none"> • Grand Design • Business Requirements • Market Liquidity and Financial Market Deepening
2009	<ul style="list-style-type: none"> • Request for Proposal (RFP) • Product Evaluation • Procurement Process
2010	<ul style="list-style-type: none"> • Procurement Process • Dissemination of Participants and other Stakeholders • Formulation of Regulation
2011	<ul style="list-style-type: none"> • Formulation of Functional Specifications and Design Specifications • Development (Product Customization) • Dissemination of Participants and other Stakeholders • Formulation of Regulations (BI Regulation and Circular Letter)
2012	<ul style="list-style-type: none"> • Testing (Unit Test, SIT, UAT, UIT, Simulation/Industrial Test) • Dissemination to Participants and other Stakeholders • Formulation of Regulations (BI Regulation, Circular Letter, SOP, guidance) and By-laws • Training for Participants • Preparation for Implementation • Implementation
SIT = System Integration Test; SOP = Standard Operating Procedure; UAT = User Acceptance Test; UIT = User Integration Test Source: Bank Indonesia.	

Japan (JPN)

1. Bond Market Infrastructure

1.1 Overview of Bond Markets

There are two major bond markets in Japan, which are the over-the-counter (OTC) market and the securities exchange market. The exchange market is operated by the Tokyo Stock Exchange (TSE). Most bonds are traded on the OTC market. The pre-settlement matching system (PSMS) is provided by the Japan Securities Depository Center, Incorporated (JASDEC) for all types of debt securities traded on the OTC market. However, some transactions go directly to the central securities depositories (CSDs). Regarding clearing systems, the Japan Government Bond Clearing Corporation (JGBCC) is the central counterparty (CCP) for Japanese government bonds (JGB); Japan Securities Clearing Corporation (JSCC), which was established by the TSE and four other securities exchanges, and the Japan Securities Dealers Association, are clearing organizations that conduct the Financial Instruments Obligation Assumption Business under the *Financial Instruments and Exchange Law*. There are two CSDs in the Japan bond market: Bank of Japan (BOJ), which operates the BOJ-NET and is the CSD of JGBs, and JASDEC, which is the CSD for all other securities in Japan. All securities can be settled with central bank money (Japanese yen) using delivery versus payment (DVP). These descriptions are mainly about bond transactions in the OTC market. Part 3, Figure D.1 illustrates the bond market infrastructure diagram.

1.2 Description of Related Organizations

The Japan Securities Depository Center, Incorporated (JASDEC)

JASDEC was founded on 6 December 1984 as a non-profit foundation and began operations on 9 October 1991. It was incorporated on 4 January 2002 and began operations as a stock company, JASDEC Incorporated, on 17 June 2002. The stock company is owned by its depository participants, which include securities companies, banks, insurance companies, securities finance companies, and stock exchanges.

The Tokyo Stock Exchange (TSE)

TSE is a stock corporation that provides an exchange securities market under the authorization of the Prime Minister. TSE is a central institution in the secondary

market and its major functions include provision of a market place, monitoring trading, listing securities, monitoring listed securities, and supervision of trading participants.

The Japan Government Bond Clearing Corporation (JGBCC)

JGBCC was established through a joint capital investment by major market participants, namely securities companies, banks and money-market brokerage companies to enhance the safety, efficiency of, and convenience in the Japanese government bond market.

Japan Securities Clearing Corporation (JSCC)

JSCC was established in 2002 as the first cross-market clearing organization in the Japanese securities market by the TSE, Osaka Securities Exchange, Nagoya Stock Exchange, Sapporo Securities Exchange, Fukuoka Stock Exchange, and the Japan Securities Dealers Association. In January 2003, JSCC was licensed as the first clearing organization in Japan to conduct the securities obligation assumption business now called the financial instruments obligation assumption business under the *Securities and Exchange Law* (now called the *Financial Instruments and Exchange Law*).

Bank of Japan (BOJ)

BOJ is the central bank of Japan. BOJ deals with the entire business of JGBs, namely issuance, interest payment, and redemption. BOJ is also the central depository of JGBs. Settlement of funds and Japanese Government Securities arising from the above operations are facilitated by the BOJ Financial Network System (BOJ-NET).

1.3 Trading

Bonds are mostly dealt in the OTC market. The seller and buyer trade through telephone, fax, the Proprietary Trading System (PTS), or systems operated by information vendors.

JASDEC provides PSMS for all types of debt securities, though some transactions go directly to the CSDs. It also serves a pre-settlement matching function for clearing and DVP settlement, and post-trade matching function.

1.4 Central Counterparty

Approximately 40% of JGB market domestic transactions are cleared by the JGBCC, which is the CCP for JGB.⁶ JGBCC replaces a contract between two parties to a JGB trade with two contracts: one between JGBCC and the buyer, and the other between JGBCC and the seller. Cash and securities positions between JGBCC and participants are netted and settled on a DVP basis using BOJ-NET. Netting reduces the value of JGB transfers to roughly a quarter of the value of the original transactions. JSCC is the CCP for exchange market transactions.⁷

⁶ Cross-border transactions are processed directly by the CSD (BOJ-NET) without using the CCP (JGBCC).

⁷ The transactions traded on the TSE are cleared by JSCC. JSCC plays a role in assuming obligation, guarantee settlement, netting funds and securities for transfer, and instructing a settlement facility for transfer. JSCC stipulates the criteria for the qualifications to become clearing participants, to whom JSCC acts as the counterparty of the obligations. In addition, JSCC establishes a scheme to guarantee settlements in place, as well as performs the DvP settlement between clearing participants and the JSCC.

1.5 Bond Settlement

1.5.1 Bond Settlement for Government Bond Market

The BOJ is the CSD of JGBs. It operates the BOJ-NET, an online network system linking BOJ and other financial institutions. The BOJ-NET is used for funds transfer services, as well as JGB-related services, including settlement and other services, namely auction and initial payments for the issuance of JGBs. The business application of the BOJ-NET for JGB-related services is called BOJ-NET JGB Services. BOJ-NET JGB Services started operation in 1990 to enable online processing of JGB-related services.

BOJ-NET's network is also called BOJ-NET. The type of line used is VPN. The protocol used is TCP/IP.

1.5.2 Bond Settlement for Other Types of Bond Market

JASDEC is the central depository for all types of bonds, except JGBs. Under the dematerialized system, it is compulsory for all listed securities to be transferred on JASDEC's Book-Entry Transfer System. Transaction settlement includes securities only, with cash settling separately through the BOJ.

The book-entry transfer system is called the JASDEC network. Types of lines are Integrated Services Digital Network (ISDN) and leased line. The protocol is TCP/IP while the interface used is Common Object Request Broker Architecture (CORBA). Message formats are ISO 15022 and comma separated values (CSV).

1.6 Cash Settlement

Cash settlement of bond transactions uses central bank money. For cash settlement obligations for domestic bond transactions, JGBCC has an account with the BOJ.

Intraday overdraft is allowed, provided that there is a collateral to secure debt incurred as a result of use of the intraday overdraft facility. The liquidity-saving feature of the BOJ-NET real-time gross settlement (RTGS) system enables the smooth settlement of bond transactions.

2. Typical Business Flows

2.1 Delivery-Versus-Payment Transaction Flow for Domestic Japanese Government Bond Trade (OTC Market)

The data are entered to BOJ-NET from both seller and buyer, and settled simultaneously. Delivery-versus-payment (DVP) settlement is effected by locking all related accounts and releasing them simultaneously. The bond transaction flow for domestic trades in the OTC market (DVP) for JGBs is illustrated in Part 3, Figure D.2.

2.2 Delivery-Versus-Payment Transaction Flow for Cross-Border Japanese Government Bonds Trade

Trade order is placed from a foreign institutional investor (FII) to a global broker then to a domestic broker. The trade flow is a typical one as shown in Part 3, Figure D.3.

Japan is an open market where third party foreign exchange is entirely possible and used frequently. Japanese yen is available in international financial markets. Also, a global custodian, or even large FIIs or their investment managers, may have their own treasury function based in Tokyo. Thus, trades are funded into a domestic custodian a/c in Japanese yen on settlement day.

An initiative called “Towards Japan Securities Settlement Systems and Infrastructure Reform” established by the Securities Settlement System Reform Promotion Working Group, which was convened by the Committee for Reform of Securities Clearing and Settlement System, started in year 2000 to develop a more efficient, more accessible, and lower risk securities settlement system in Japan.

The bond transaction flow for foreign investors in the OTC market (DVP) is shown in Part 3, Figure D.3.

2.3 Delivery-Versus-Payment Transaction Flow for Domestic Japanese Government Bonds Trade in the Over-the-Counter Market after the New BOJ-NET

The New BOJ-NET will be made possible to be connected with PSMS and JGBCC. If the New BOJ-NET is connected with PSMS after establishment of the New BOJ-NET, the trade data are directly transmitted from PSMS to BOJ-NET.

An example of the DVP transaction flow which uses PSMS in the case that New BOJ-NET is connected with PSMS is shown in Figure JP04 of Part 3: Bond Transaction Flow for Domestic Trades: OTC Market (JGB)/DVP.

An example of the DVP transaction flow which uses PSMS and JGBCC in the case that New BOJ-NET is connected with PSMS and JGBCC is shown in Figure JP05 of Part 3.

2.4 DVP Transaction Flow for Domestic Corporate Bond Trade (OTC Market)

DVP transaction flow for domestic corporate bond trade is shown in Part 3, Figure D.6.

3. Matching

Pre-Settlement Matching System

The PSMS provides a framework for electronic matching on trades and settlements for institutional investor transactions between investment management companies, securities companies, trust banks, custodian banks, life and non-life insurance companies to achieve the seamless, automated processing of all operations from post trade through to settlement. Moreover, PSMS provides an advanced matching function for DVP book-entry transfer settlements conducted by JASDEC, as well as for clearing by the JGBCC. Please refer to Appendix 2. Some transactions are directly matched in the CSD (BOJ-NET), which provides local matching facility. Both seller and buyer enter trade data and the data are forwarded to the counterparty. If the data are correct, the counterparty will send them back to the BOJ-NET with an affirmative message.

A few variations of trade matching by PSMS are shown in Part 3, Figure D.7.

4. Settlement Cycle

The standard settlement cycle of domestic transactions is T+3. The settlement cycle of cross-border transactions is T+2~T+4. One reason for the difference is that business processes are different between domestic transactions and cross-border transactions. Cross-border transaction may require additional operations by the global and local custodians. Another reason is the time-zone differences between North America, Europe, and Japan.

The settlement cycle for outright DVP transaction will be shortened to T+2 beginning April 2012 for domestic transactions. An initiative to shorten settlement cycle is discussed later in the “Medium- to Long-Term Strategy.”

5. Numbering and Coding

5.1 Numbering and Coding for Over-the-Counter and Exchange Markets

5.1.1 Securities Numbering

The New BOJ-NET will adopt International Securities Identification Number (ISIN) as securities identification number. JASDEC has already adopted ISIN for bonds and it will be the standard for securities identification in Japan. A relationship between ISIN and local numbering is shown as follows.

Figure 4.1 Local Numbering Scheme and Codes for International Securities Identification Number

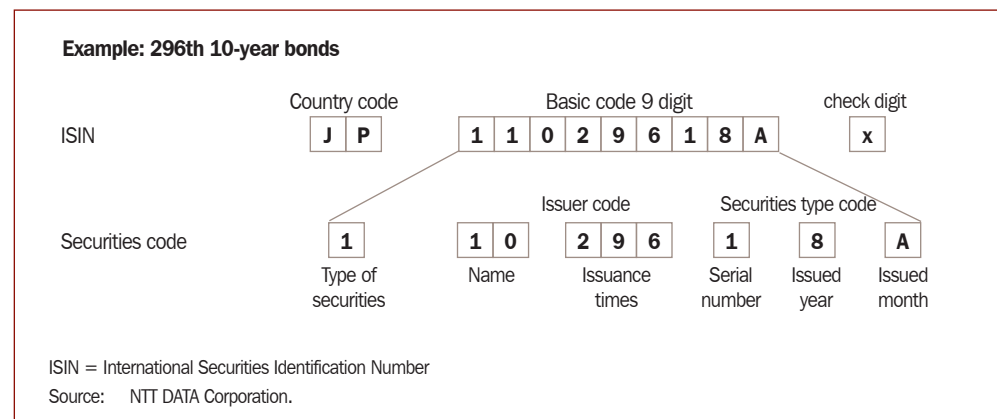

5.1.2 Financial Institution Identification

Currently, only proprietary financial institution identification codes are used in the CSDs for JGBs. New BOJ-NET will adopt the Business Identifier Code (BIC) in addition to the current proprietary codes.

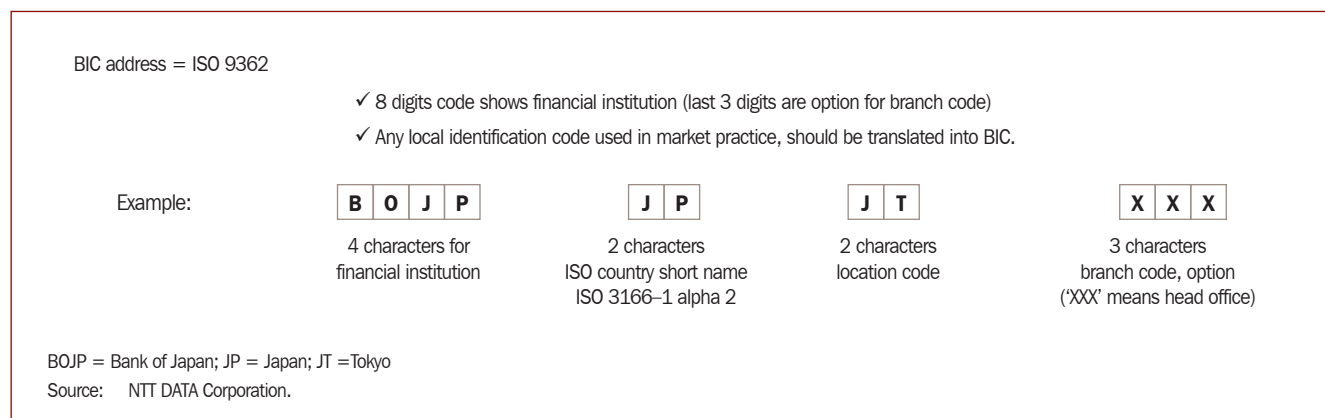
Figure 4.2 Financial Institution Identification

5.1.3 Securities Account

Securities account uses practically proprietary numbering. The current proprietary account structure will be used for the New BOJ-NET. The following is a brief description of the account structure based on BOJ regulations on the JGB book-entry system.

Divisions of Direct Participant's Account¹

1. The Direct Participant's Account shall be divided into the following:
 - a. The account into which the description or record of the book-entry JGBs to which the relevant Direct Participant holds the rights shall be made (hereinafter referred to as the "Direct Participant's Account [Proprietary ledger]"); and
 - b. The account into which the description or record of the book-entry JGBs to which Customers of the relevant Direct Participant, or its Lower-Positioned Institutions, hold the rights shall be made (hereinafter referred to as the "Direct Participant's Account [Customer ledger]").
2. The Direct Participant's Account (Proprietary ledger) and the Direct Participant's Account (Customer ledger) shall have subdivisions for each Classification as separately provided by the BOJ. In such case, the Direct Participant's Account (Proprietary ledger) shall have a subdivision into which the book-entry JGBs, which are subject to a pledge, are described or recorded, and the other subdivision into which other book-entry JGBs are described or recorded.

¹ Bank of Japan. 2009. Regulations concerning the Japanese Government Bonds Book-Entry System. http://www.boj.or.jp/en/paym/jgb_bes/data/fyoryo01.pdf

The securities account structure is illustrated as follows.

Figure 4.3 Securities Account Structure

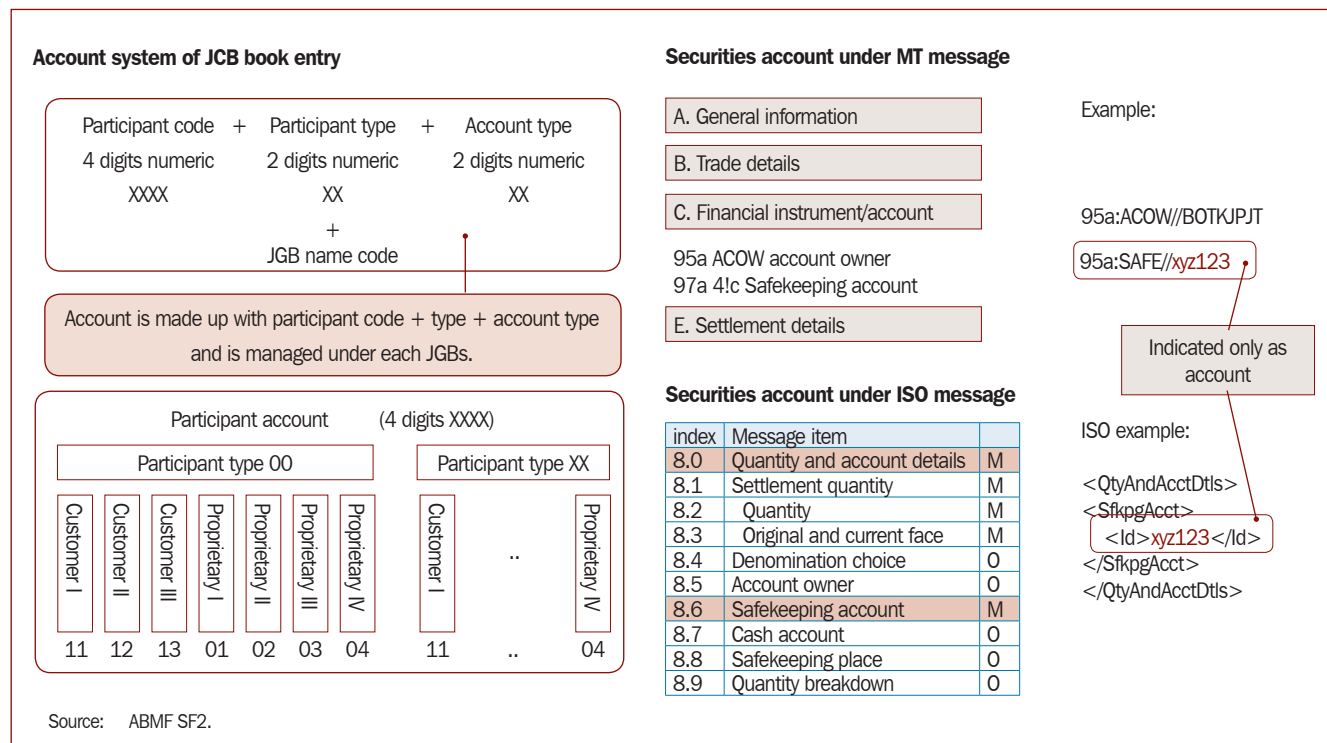

5.1.4 Cash Accounts

Cash accounts use practically proprietary numbering.

5.1.5 Character Code and Language

UTF-8 contains the Japanese settlement system’s character set. The current BOJ-NET adopts Japanese Industrial Standards (JIS). The New BOJ-NET will adopt Unicode using UTF 8 as the encoding scheme. The language for the New BOJ-NET will be Japanese. Image of character code sets and language are illustrated in Figure 4.4.

Figure 4.4 Character Code Sets and Language in the Japanese Settlement System

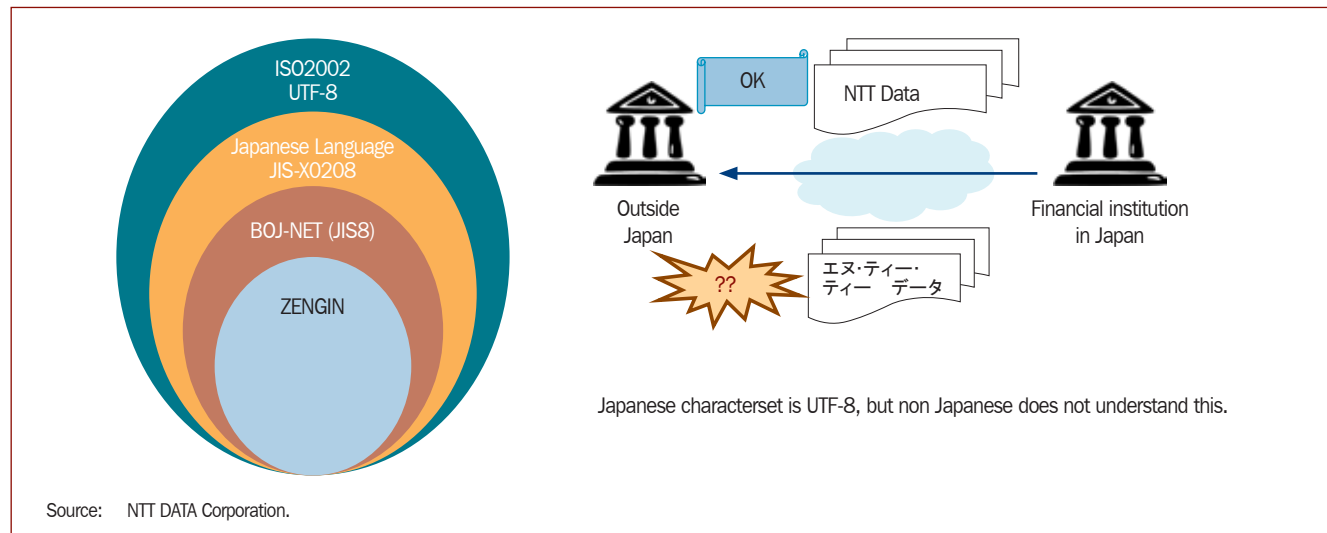

6. Medium- to Long-Term Strategies

Regarding message standardization compliance with ISO 20022, JASDEC will introduce ISO 20022 message formats in 2014 not only to PSMS but also to Book-Entry Transfer Systems. JASDEC will also introduce SWIFTNet by 2014, and will terminate the customized ISO 15022 message format by 2019.

The BOJ will adopt ISO20022 message formats for some transactions under the new BOJ-NET, which will start operating for some areas around the first quarter of 2014 and the remaining areas between the autumn of 2015 and the beginning of 2016.

On the matter of settlement cycle, a working group tasked to shorten the settlement cycle for Japanese government bonds was established in September 2009 under the Reform Promotion Center for Securities Clearing and Settlement System, with the Japan Securities Dealers Association serving as the secretariat of the working group.

By April 2012, the settlement cycle will be T+2. Discussion on the introduction of T+1 will restart in the second half of FY 2012.

Appendix 2:

Pre-Settlement Matching System

I. Introduction

The Pre-Settlement Matching System (PSMS) provides a framework for electronic matching on trades and settlements for institutional investor transactions between investment management companies, securities companies, trust banks, custodian banks, life and non-life insurance companies, and other actors in the bond market to achieve a seamless, automated processing of all operations from orders to settlement. Moreover, PSMS provides an advance-matching function for delivery-versus-payment (DVP) book-entry transfer settlements conducted by the Japan Securities Depository Center Incorporated (JASDEC), as well as for clearing by the Japan Government Bond Clearing Corporation (JGBCC).

A. Straight Through Processing for Securities Settlement in Japan

As far as institutional transactions are concerned, it is quite common that institutions that perform investments and those that perform settlement are different entities not only in Japan but also in other countries. In Japan, however, it is typical for trust banks to retain the rights and obligations. For this reason, PSMS was developed to realize the straight through processing (STP) suitable to the specifics of the securities settlement environment in Japan.

B. Establishment and Application of Japanese Standards in Conformity with Global Standards

Securities markets have been globalized so quickly. Until recently, securities settlement systems used to be constructed on the vernacular architecture of data syntax and codes, which can be only used in the domestic market; connectivity with overseas counterparts must be incorporated in future settlements system. To achieve this, the PSMS was developed based on the following standard data syntax and codes:

- 1. Data Syntax: ISO 15022.** This data syntax was originally developed for the Society for Worldwide Interbank Financial Telecommunication (SWIFT) network as the new securities data syntax to be used beginning in autumn of 2002 and then registered with the International Organization for Standardization (ISO) as ISO 15022. ISO 15022 became the common syntax for financial institution worldwide and replaced ISO 7775, which was widely used by financial institutions all over the world. Using this data syntax makes it possible, for example, to transmit settlement instructions sent from global custodians to Japanese sub-custodians easily to the PSMS. Because of the scalable architecture of ISO 15022, it is also expected to assure the scalability of PSMS to meet future increases in the scope of securities to be handled and the diversification of types of trades.
- 2. The International Securities Identification Number.** The International Securities Identification Number (ISIN) is the standard code allocated by the Securities Identification Code Committee in conformity

with the International Securities Identification Code Standard (ISO 6166). All Japanese domestic stocks, as well as all bonds issued by public offering in Japan, are allocated with the ISIN “JP+ basic code+ check digit”. ISIN is the only globally common code, since it is allocated by the securities identification code organization of each country in accordance with the International Identification Code Standard. The adoption of ISIN will assure the same effect as the adoption of ISO 15022 mentioned above.

- 3. Business Identifier Code.** It is necessary to identify various participating parties, such as counterparties of trading and of settlement, in the PSMS by code numbers. The Business Identifier Code (BIC) is being used in the SWIFT network as the standard bank identifier code, such as the ISO 15022, and is registered with ISO as ISO 9362. To utilize the PSMS, it is necessary for all users such as banks, securities companies, investment trust companies, and investment advisory companies to obtain a BIC. In case it is not possible to obtain a BIC for some reason, other identifiers, such as the Uniform Bank Code or the Standard Code for Securities Company, will be used as a supplementary identification in the PSMS.

C. Matching on Trade Date (T+0 Matching)

While PSMS was implemented under the T+3 environment, this aims to complete the matching of trades on the trade date, T+0, to keep pace with the movement of the securities industry to a shorter settlement cycle, T+1. It is believed that completion of trade matching on T+0 will help increase convenience for investment trust management services. To be precise, open-end investment trust is required to calculate and announce the net asset value (NAV) every day, which should be done accurately and promptly. The PSMS provides facilities to match the investment instruction data sent by investment trust companies and trade report data sent by securities companies on a real-time basis, and then sends the matched data to trust banks. This enables trust banks to smoothly and accurately calculate the NAV and match such NAV calculated by investment trust companies more quickly and accurately.

D. Connecting to the Delivery-Versus-Payment System

On 17 May 2004, with the implementation of the delivery-versus-payment (DVP) system for trades other than stock exchange transactions, the PSMS linked to the Book-Entry Transfer System. The matched settlement instruction data linked to the Book-Entry Transfer System set in the PSMS is automatically transmitted to the Book-Entry Transfer System, thereby completing the settlement process without any manual interventions. The participation to PSMS is a requisite for putting the DVP settlement into practice.

E. Digitization and Dematerialization

Digitization of trade data and dematerialization or immobilization of securities is a prerequisite for bringing STP into operation. As a practical step, an amendment to the *Ordinance of the Cabinet Office* was issued on 1 October 2001, which allows securities companies to send trade reports to their customers in electronic or magnetic form through the PSMS, upon the agreement of customers.

F. The Average Price: The New Pricing Framework in Japan

On 7 July 2003, an amendment to the *Ordinance of the Cabinet Office* on securities companies and the members' notification of the Japan Securities Dealers Association (JSDA No. 15-33) relating to the average price were issued. This allowed securities companies not to send to their customers trade confirmations regulated by the *Securities and Exchange Law* under Art. 41. It also allowed sending trade reports, using an average price with the conditions such as agreement of customers, under the *Ordinance of the Cabinet Office* on securities companies. This amendment made it possible for securities companies to send trade reports using average price to their customers in the electronic or magnetic form through the PSMS.

G. Connecting to Japan Government Bond Clearing Corporation

Since May 2005, the Japan Government Bond Clearing Corporation (JGBCC) started the clearing business of Japan government bonds. At the same time, PSMS linked data to the JGBCC system. The matched trade-report data of Japanese government bonds linked to the JGBCC set in the PSMS is automatically transmitted to the JGBCC system; the PSMS receives data generated by the JGBCC system such as credit approval status, netting result, among others, and sends these data to JGBCC participants.

II. Domestic Transactions

A. Scope of Services

The PSMS is developed to perform the post-trade procedure mainly for institutional investor; thus, it covers both transaction types on the buy-side, consisting of investment managers (investment trust management companies and/or investment advisory companies) and trust banks, which perform matching for specified money trust transactions, and another buy-side consisting of institutional investors, such as life or non-life insurance companies and trust banks, which perform matching for their own transactions, known as the Proper Type. Further, the former buyer type can be categorized into three sub-types based on the difference of data-transmission method between the investment managers and the trust banks: 1) Three-party Center Matching Type (Without Using Investment Instruction Distribution Service), 2) Three-party Center Matching Type (Using Investment Instruction Distribution Service), and 3) Investment Instruction Support Unsubscribed. As far as bonds are concerned, PSMS provides two more transaction types: Through Type and Two-party Center Matching. Under the Through Type, the PSMS is not used for matching investment instruction data and trade report data while the Two-party Center Matching involves two parties confirming the result of a bilateral trade.

- 1. Three-party Center Matching Type (Using Investment Instruction Distribution Service).** This type does not receive Investment Instruction Data from investment managers, but PSMS, on their behalf, generates Investment Instruction Data based on Trade Report Data sent from the securities companies, and transmits the data to the investment managers. After checking the contents of the data, investment managers send it back to the PSMS as Investment Instruction Data. Investment managers are able to replace the Notice of Execution by fax from securities companies by electronic data transmission.

- 2. Investment Instruction Support Unsubscribed Type.** This type is used when investment managers do not participate in the PSMS and send Investment Instruction Data (or Investment Instruction Statement) to trust banks by some other means. In this case, trust banks receive only Trade Report Data sent by securities companies via PSMS, match Trade Report Data internally with Investment Instruction Data (or Investment Instruction Statement) received by some other systems or methods, and send the Trade Report Affirmation Data to the PSMS.
- 3. Through Type.** This type is used when PSMS is not used for matching investment instruction data and trade report data. Investment instruction data from investment managers and trade report data from brokers or dealers are transmitted to trust banks, respectively. In this case, the trust banks match these two data internally and send the Trade Report Affirmation Data to the PSMS.
- 4. Proper Type.** This type is used by the buy-side consisting of institutional investors, such as life or non-life insurance companies or trust banks who perform investments and settlement for their own transactions. As the party in the transaction in this case is only one, the matching process becomes simpler than specified money trust transactions, eliminating the transmission or receipt of Investment Instruction Data.
- 5. Two-party Center Matching Type.** This type is used when two parties confirm the result of a bilateral trade, and both the seller and buyer send the trade report data to the PSMS, respectively. The PSMS executes matching of trade report data from the seller and the buyer and immediately transmits the Notice Data of Trade Matching Status.

B. Outline of Matching Process

The matching process for the Three-party Center Matching Type (Without Using Investment Instruction Distribution Service) is described below:

- 1. Transmission of Trade Report Data and Investment Instruction Data.** As stated above, the Order from investment managers to securities companies, the Notice of Execution from securities companies to investment managers, and the allocation between investment managers and securities companies are beyond the scope of services. Service starts from the transmission of Trade Report Data from securities companies and Investment Instruction Data from investment managers. The data syntax used for Trade Report Data is MT515 of ISO 15022 and that for Investment Instruction Data is MT541/543 (Buy/Sell) (Figure A2.1 ① and ②).
- 2. Matching of Trade Report Data and Investment Instruction Data (Trade Matching)** (Figure A2.1 ③). When the Trade Report Data and Investment Instruction Data are received, PSMS searches for the data to be matched in accordance with the matching logic. When the data to be matched are specified, the matching procedure takes place and the Notice Data of Trade Matching Status (MT509) are transmitted to the investment manager and the securities company (originators of matching data) in real-time, together with the status information of “Matched” or “Unmatched” (Figure A2.1 ④). In case the status information is “Unmatched”, the reason for discrepancy and details of counterparty for unmatched item will be transmitted.

- 3. Transmission of Trade Report Data and Investment Instruction Data to Trust Banks and Trade Report Affirmation /Disaffirmation Data** (Figure A2.1 ⑤, ⑥, ⑦, and ⑧). When the data is matched, the Trade Report Data and Investment Instruction Data are immediately transmitted to the trust banks (Figure A2.1 ⑤ and ⑥). The trust banks then confirm the details of data and send out the Trade Report Affirmation or Disaffirmation Data (“Affirmed” or “Disaffirmed”, MT517) (Figure A2.1 ⑦). Upon receipt of such data, the PSMS transmits the Notice Data of Trade Report Affirming Status to the securities companies (MT509) (Figure A2.1 ⑧). In case the status indicates “Disaffirmed” by the trust banks, securities companies (or/and investment managers) cancel the previously sent Trade Report Data (or/and Investment Instruction Data) and resend the corrected Trade Report Data (or/and Investment Instruction Data).⁸
- 4. Generation of Settlement Instruction Data** (Figure A2.1 ⑨ and ⑩). When a Trade Report Affirmation or Disaffirmation Data sent by trust banks carries the “Affirmed” flag, the process moves to the generation of settlement instruction data. To realize the straight-through nature of the process, the PSMS provides the Standing Settlement Instruction (SSI) database to register settlement conditions such as key account information for all trading parties. By using this database, the PSMS automatically generates and transmits Settlement Instruction Data to the settlement matching unit, and eliminates manual efforts of creation and transmission of the settlement instruction data by trust banks and securities companies (Figure A2.1 ⑨). Then, the Notice of Settlement Matching Status Data (MT548) with “Matched” status will be sent to both parties (Figure A2.1 ⑩).
- 5. Generation of Delivery-Versus-Payment Order.** When Settlement Instruction Data carrying a “LINK/DVP” is matching, the PSMS immediately prepares a Delivery-Versus-Payment (DVP) Order from the matched settlement instruction data of both deliverer and receiver and transmits the order to the Book-Entry Transfer System (Figure A2.1 ⑪).

⁸ As ISO 15022 does not have the function to correct data elements, or the re-submission of corrected specific element is not available, the cancellation of all elements of previously sent data and re-entry of the corrected data have to be transmitted.

Figure A2.1 Domestic Transactions—Three-Party Center Matching Type
 (Without Using Investment Instruction Distribution Service)

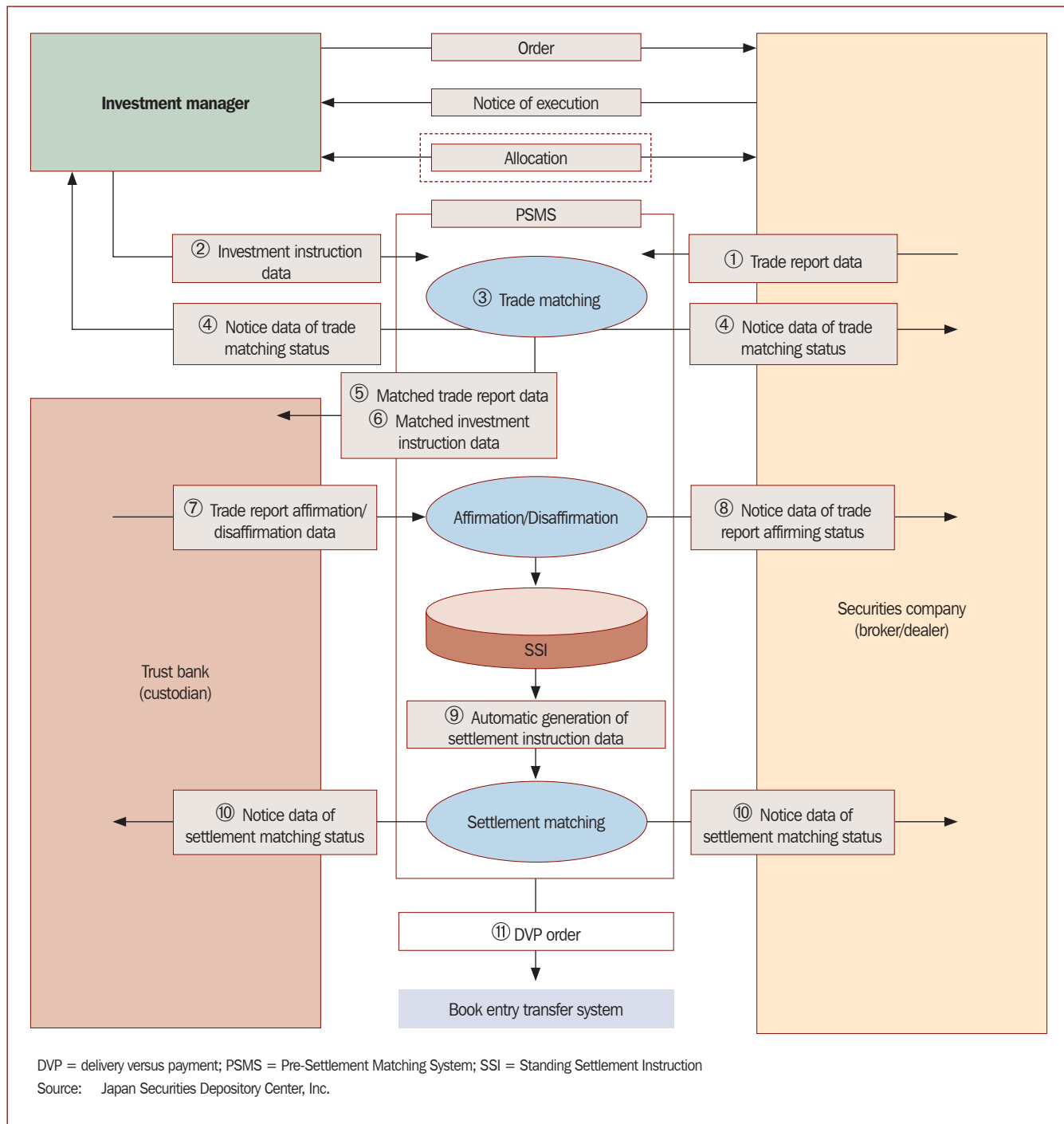

III. Non-Residents' Transactions

A. Scope of Services

In case of non-residents' transactions, trade matching is not performed, but matching of Settlement Instruction Data sent from settlement agents, such as banks and securities companies who perform custody operations for Japanese securities traded by non-residents, is utilized (Figure A2.2).

B. Outline of the Matching Process

1. **Transmission of Settlement Instruction Data or Notice Data of Settlement Matching Status (Figure A2.2 ① and ②).** When Settlement Instruction Data (MT540 to 543) are received from settlement agents, such as banks and securities companies who perform custody operations (Figure A2.2 ①), PSMS searches for the data to be matched in accordance with the matching logic. When the data to be matched are specified, the matching procedure takes place and Notice Data of Settlement Matching Status (MT548) are transmitted to both the deliverer and receiver in real-time with the following corresponding status: "Unmatched" when there is one or more unmatched items; "Matched (settlement not executable)" when all items are matched but with Release Flag, which carries the information whether the settlement is executable or not, on either deliverer or receiver side stays "Release Not Executable"; or "Matched (settlement executable on settlement date)" when all items are matched and Release Flags on both sides stay "Release Executable" (Figure A2.2 ②).
2. **Transmission of Settlement Instruction Modification Data or Notice Data of Settlement Instruction Modification Completion Data (Figure A2.2 ③ and ④).** When the Release Flag in the Settlement Instruction Data states "Release Not Executable," settlement agents resend the correction data (MT599) to change the Release Flag to "Release Executable" after checking the balance of securities or funds, which caused the delivery to be suspended, and making the delivery to be executable (Figure A2.2 ③). When the modified data are received, the PSMS rewrites the Release Flag of Settlement Instruction Data already recorded, and transmits the modification completion data (MT548 or 578) with the corrected status to both deliverer and receiver (Figure A2.2 ④).
It should be noted that the modification data could be issued not only to change the Release Flag but to correct the settlement amount.
3. **Generation of Delivery-Versus-Payment Order (Figure A2.2 ⑤).** When the Settlement Instruction Data carrying "LINK/DVP" is matching, the PSMS immediately generates a DVP Order from the matched settlement instruction data of both deliverer and receiver and transmits the order to the Book-Entry Transfer System (Figure A2.2 ⑤).

IV. Network and Connection with Users

A. User Connection Format

The formats of connection to the PSMS by users can be in two ways. One is to connect the user's own system directly (Central Processing Unit Direct Connection) to the

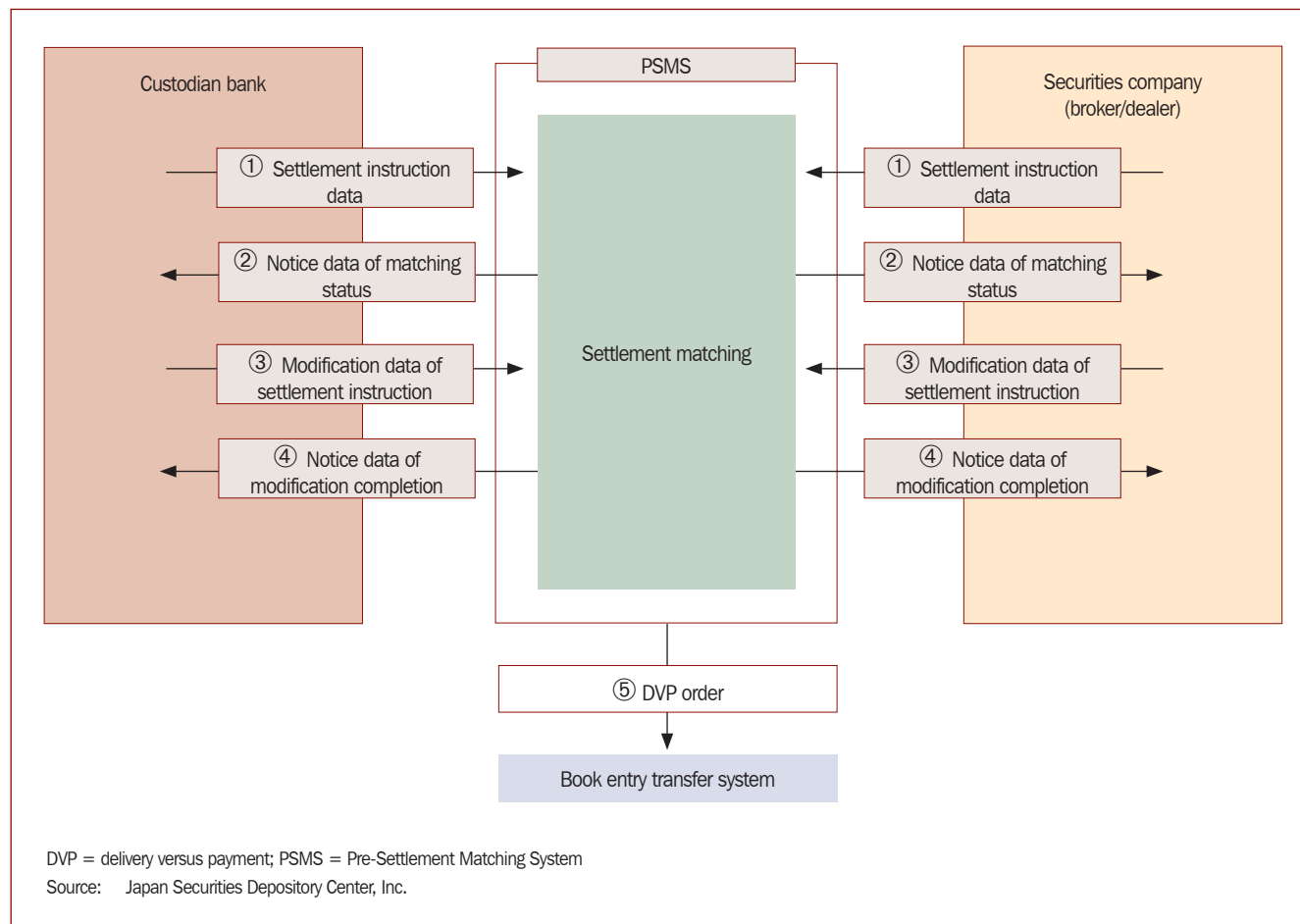
Figure A2.2 Non-Residents' Transactions

PSMS and the other is to use a personal computer (PC) with a web browser as a terminal of the PSMS (Terminal Connection). The former can utilize either of two types of processing: online real-time processing and batch processing by file transfer. For online real-time processing and batch processing by file transfer, users can choose either to connect their own systems to the PSMS, or to have the systems of their computer service subcontractors connected to the PSMS. In the case of online real-time processing, dedicated lines are commonly used; for file transfer and terminal connection, Integrated Services Digital Network lines are used.

B. Terminal Functions

For users who have large volume of trades, direct online real-time connection of their systems to the PSMS is efficient in view of the possibility to further shorten the settlement cycle in the future. However, for users who do not have large volume of trades and wish to curtail the initial investment for system development, Terminal Connection to the PSMS is convenient. To utilize the services provided, users only need to prepare a PC with certain specifications and a web browser, and log on to the web server of the PSMS. The transmission or receipt of data explained above is possible by means of this terminal function. For data transmission, users may choose either key-input through the form on-browser or comma separated value file transfer.

Republic of Korea (KOR)

1. Bond Market Infrastructure

1.1 Overview of Bond Markets

The Korean bond market is comprised of the over-the-counter (OTC) market and exchange market operated by the Korea Exchange (KRX). In Korea, four types of bonds are traded on the markets such as Korean government bond (KGB), corporate bond, commercial paper (CP), and Certificate of Deposit (CD). About 70% of bond trades are performed on the OTC market, whereas other bonds are traded on the exchange market. For Trade matching, KRX executes matching for trade on the KRX market while Korean Securities Depository (KSD) execute it for other Trades on the OTC market. KRX is also designated to provide clearing service on the exchange market. For settlement, KSD is in charge of securities settlement for all kinds of bonds while the Bank of Korea (BOK) is in charge of cash settlement as a central bank. The bond market infrastructure in Korea is shown in Part 3, Figure E.1.

1.2 Description of Related Organizations

Financial Supervisory Service (FSS)

The FSS acts as the Financial Services Commission's (FSC) executive arm. The main objectives of the FSS are to provide supervision and conduct examination and investigation of financial institutions to ensure sound and fair trading practice in the financial markets and to protect investors.

Korea Financial Investment Association (KOFIA)

KOFIA was launched on 4 February 2009 through the merger of three associations representing the securities, asset management and futures industry, as set forth by the *Financial Investment Services and Capital Markets Act (FISCMA)*, which took effect the same day. To provide transparent and accurate information to participants, KOFIA established FreeBond and manages the OTC market.

Korea Exchange (KRX)

The former three exchanges in Korea, i.e., the Korea Stock Exchange (KSE), Korea Futures Exchange (KOFEX), and the Korean Securities Dealers Automated Quotations (KOSDAQ) Market, have merged into the KRX effective 27 January 2005.

KRX maintains a fair and orderly market for trading securities; it also regulates and supervises its member firms via market operational rules set by the KRX.

Korea Securities Depository (KSD)

KSD was established in 1974 to act as the central depository of the Korea market. KSD is the single central securities depository (CSD) in Korea. In 1994, KSD became a non-profit making organization by increasing its shareholders. The shareholders of the KSD are various market participants, KRX, banks, and other banking corporations.

The name of KSD's network is SAFE+. The types of lines are leased line (front end processor [FEP]) and the Internet.

The Bank of Korea (BOK)

BOK was created on 12 June 1950 under the *Bank of Korea Act*. BOK conducts the typical functions of a central bank such as issuance currencies, formulation and the implementation of monetary and credit policy, as bankers' bank, and as the government bank.

1.3 Trading

1.3.1 Over-the-Counter Market

In the Korean OTC market, the seller and buyer trade bonds mostly via a private messenger and partly through the FreeBond. FreeBond, which is run by KOFIA, enables financial investment firms and major market practitioners to search bid or ask prices for trading and intermediation in the OTC bond market. FreeBond also supports trading negotiation with trading counterparties. It consists of two components: Trading-Board (T-Board) and messenger. T-Board has many functions, such as searching bid prices, ordering, negotiation, confirming trade, providing real-time information on bid prices, and analyses. Messenger actualizes one versus N-chatting, storing and using chatting frame layout, and chatting room service. The operation of FreeBond is illustrated as follows.

Figure 5.1 Operation of FreeBond

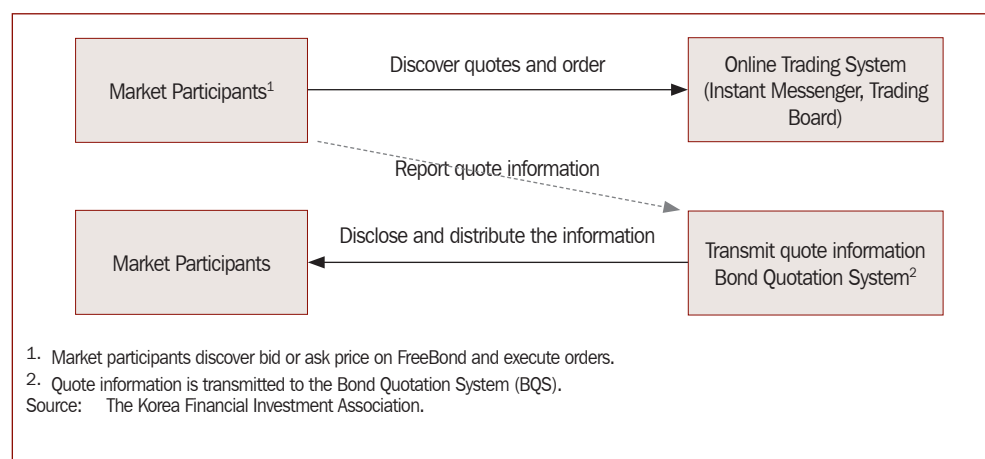

KOFIA is planning and working on adding matching service and link Freebond to the settlement system (or institution) when related laws and regulations in the country changes.

The centralization and disclosure of OTC quotations is illustrated as follows.

Figure 5.2 Centralization and Disclosure of Over-the-Counter Quotations

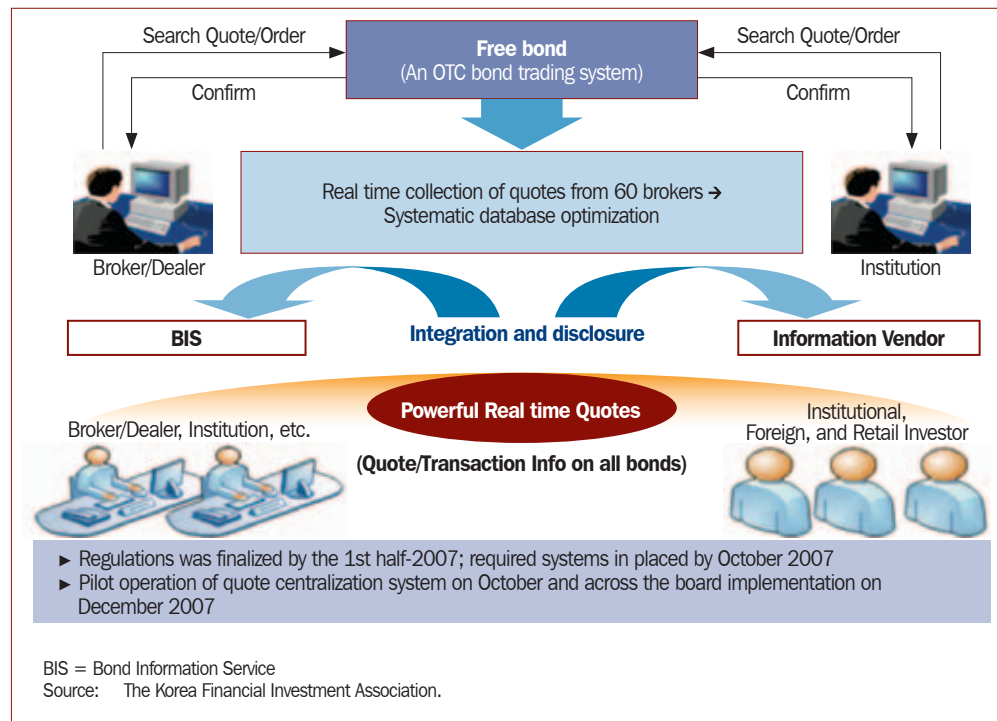

If the client is a foreign investor, the seller side and/or the buyer side of securities companies transfer order information to the FSS via the Foreign Investment Management System (FIMS). After acceptance of order information, FSS judges acceptance or rejection of the order. FSS determines whether to accept or reject the order. If holding is enough, the FSS transfers order information to the seller side and/or the buyer side of securities companies and the KRX.

A screen image of the Bond-Trade Report and Information Service (B-TRiS) is shown in Figure 5.3.

A financial investment company engaging in bond trading shall, when trading or brokering bonds with investors in the OTC market, report to KOFIA the details related to such trading within 15 minutes from the point of settlement of the sales agreement, using B-TRiS to enhance transparency on the OTC bond market. After reporting, KOFIA discloses this information on its website.

Figure 5.3 Screen Image of the Bond-Trade Report and Information Service

The screenshot displays the 'Real-time Trading Information' service interface. At the top, there is a clock and the text 'Real-time Trading Information' with a timestamp of '10:14:45 PM'. Below this, there are navigation tabs for 'Real-time Trading Summary' and 'Daily Trading Summary'. A search filter section includes dropdown menus for 'Credit Rating' (set to 'All'), 'Market' (set to 'OTC'), and 'Trading' (set to 'All'). There are also input fields for 'Time to Maturity' (Year(s) and Month(s)) and 'Search Criteria' (All, Volume, Value) with a 'Value' field set to '1000' and a unit of 'KRW ml or more'. A 'Search' button is present. Below the search filter, there are tabs for 'Comprehensive', 'Government', 'Municipal', 'Special', 'MSB', 'Bank', 'Other Financial', 'Corporate', and 'ABS'. The main section is titled 'Real-time Trading Summary' and contains a table of bond trades. The table has columns for 'Time', 'Instrument', 'Time to Maturity', 'Credit Rating', 'Yield', 'Unit Price (KRW)', 'Change', 'Agency Avg', and 'Volume'. The data is sorted by time, showing various bond instruments like 'MONETARY STABILIZATION BOND', 'KOREA TREASURY BOND', and 'INDUSTRIAL BANK OF KOREA' bonds.

Time	Instrument	Time to Maturity	Credit Rating	Yield	Unit Price (KRW)	Change	Agency Avg	Volume
16:18:46	MONETARY STABILIZATION BOND45-725-2-25	01y10m24d		3.960	9,947	0.010	3.97	1,000,000
16:18:21	HANJIN HEAVY INDUSTRIAL121	02y10m26d	AA	6.500	9,899	0.240	6.26	232,848
16:15:29	KOREA TREASURY BOND0475-1403	04y09m09d		4.590	10,213	0.030	4.56	1,000,000
16:15:24	KOREA TREASURY BOND0475-1403	04y09m09d		4.590	10,213	0.030	4.56	1,000,000
16:14:58	INDUSTRIAL BANK OF KOREA(S)0901DE185A-30	00y01m01d	AAA	2.170	9,901	-	2.17	1,000,000
16:14:40	TREASURY BOND0500-1609	07y02m09d		4.960	10,178	-0.030	4.99	130,000
16:14:36	INDUSTRIAL BANK OF KOREA(S)0901DE185A-30	00y01m01d	AAA	2.170	9,901	-	2.17	1,000,000
16:14:07	MONETARY STABILIZATION BOND0009-0713-0200	00y09m11d		1.910	9,994	-	1.91	1,010,000
16:13:51	MONETARY STABILIZATION BOND0009-0713-0200	00y09m11d		1.910	9,994	-	1.91	1,010,000
16:13:36	KOREA TREASURY BOND0575-1609	09y02m09d		5.040	10,895	-0.040	5.08	1,000,000
16:13:18	MONETARY STABILIZATION BOND45-725-2-25	00y09m23d		1.920	10,124	-	1.92	1,000,000
16:13:02	MONETARY STABILIZATION BOND45-725-2-25	00y09m23d		1.920	10,124	-	1.92	1,000,000
16:12:59	TREASURY BOND0500-1709	00y02m09d		5.060	10,461	-0.030	5.09	1,000,000
16:12:59	TREASURY BOND0500-1709	00y02m09d		5.060	10,462	-0.030	5.09	1,000,000
16:12:50	KOREA TREASURY BOND0575-1609	09y02m09d		5.040	10,895	-0.040	5.08	1,000,000
16:12:15	NACF-19 ABS SPECIALTY1-3	01y09m09d	AAA	5.050	10,025	5.050	0.00	200,000
16:11:32	WOORI BANK11-04COUP3023	00y09m21d	AA+	3.080	10,271	-0.020	3.10	1,000,000
16:10:02	KOREA TREASURY BOND0475-1403	04y09m09d		4.540	10,234	-0.020	4.56	1,000,000
16:08:17	TREASURY BOND0475-1309	04y02m15d		4.350	10,269	-0.290	4.64	100,000

Source: The Korea Financial Investment Association

1.3.2 Exchange Market

The KRX supplies the KRX Electronic Trading System for Government Bonds (KTS) browser system to market participants. Participants are directly connected with the KTS using the KTS browser without any additional cost, provided that Internet access is available. There are currently 65 market participants. There are currently 65 market participants, 40 of which are regular members and 25 are bond members. By function, primary dealers are 20 and secondary dealers are 45 as of January 2011.

On the KTS, securities such as the Korea Treasury bonds (KTB), Monetary Stabilization Bonds (MSB) issued by the BOK, and Deposit Insurance Fund Bonds (DIFB) issued by the Korea Deposit Insurance Corporation are traded. Trading hours are from 9:00 a.m. to 3:00 p.m. Trading lot is KRW1 billion.

Since the exchange market (KRX) is an order-driven market, bonds are traded through a competitive bidding system. The bid-and-ask orders placed by eligible participants are automatically executed by a centrally matching system. If the client is a foreign investor, the seller side and/or the buyer side of securities companies transfer the order information, as well as trading on the OTC market, to the FSS.

The KTS market structure is illustrated as follows.

Figure 5.4 Market Structure of the KRX Electronic Trading System for Government Bonds

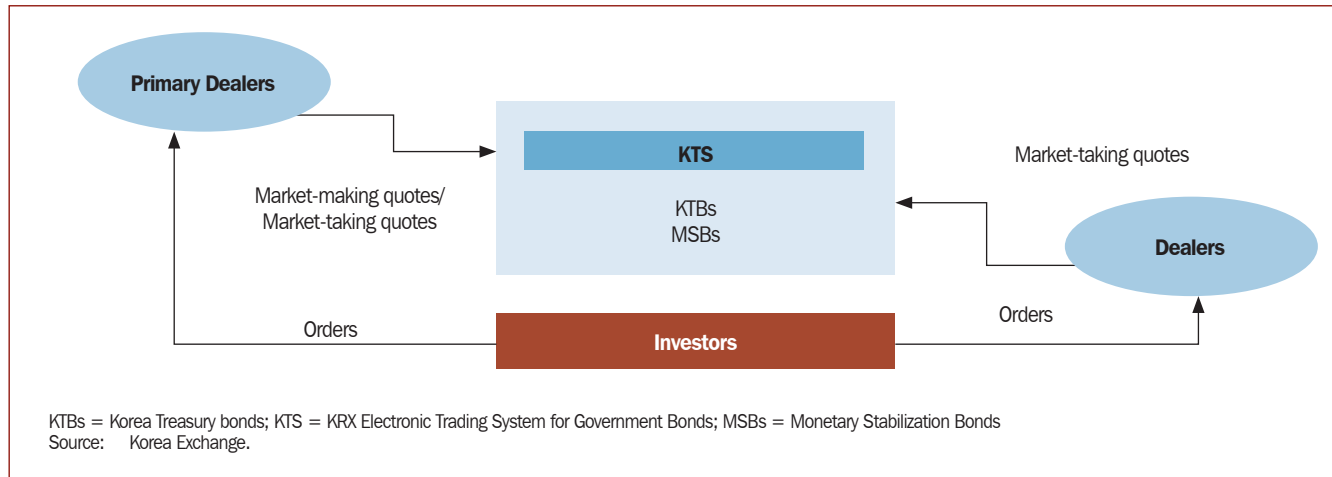

1.4 Central Counterparty Clearing

1.4.1 Central Counterparty Clearing for the Over-the-Counter Market

There is no central counterparty clearing (CCP) on the OTC market.

1.4.2 Central Counterparty Clearing for the Exchange Market

KRX owns and operates the netting system for the trades on the exchange market as a CCP. Through KRX debt assumption without responsibilities, multilateral trading in Korea's market shifts to a bilateral trading relationship between KRX and its members. This guarantees the legal validity of multilateral netting. Netting is a process that confirms the securities and charges to be delivered by members to the KRX (CCP) on the settlement date. For securities, the quantity of securities to be delivered is calculated from the balance (net) between the selling and buying quantities per issue and members. For charges, the net single position is calculated by finding the net between buying and selling charges per member. In order for settlements to be accomplished according to the calculated settlement positions, the KRX gives settlement orders to member firms and the KSD. Bond trades in the exchange market are cleared by the KRX on the multilateral netting basis. In this process, the KRX acts as the central counterparty.

1.5 Bond Settlement

1.5.1 Bond Settlement Traded at the Over-the-Counter Market

All bonds, including Korean government bonds, are deposited in registered form in the KSD. Participants of the KSD are 257 institutions (63 broker/dealer, 51 banks, 81 asset management, 23 insurance companies, 4 pension funds, and 33 others) as of the end of 2010. KSD conducts simultaneous security and cash settlement on a trade-by-trade base (Delivery-versus-Payment [DVP] Model1).

1.5.2 Bond Settlement Traded at the Exchange Market

KSD also provides DVP settlement for bond trades via the KRX market. KSD has launched a new bond settlement system since November 2011. The new system introduces DVP Model 1 after netting, whereas the previous system adopted DVP Model 3. The new system electrically connects KTS and the New Bank of Korea Financial Wire Network System (BOK-Wire+).

1.6 Cash Settlement

BOK owns and operates BOK-Wire+ for cash settlement system. BOK-Wire, introduced in December 1994, was a large-value payment system owned and operated by the BOK. Through this system, the BOK provided funds-transfer service via participants' current accounts with the BOK. In November 1999, the BOK also began providing a DVP service, and in December 2004 it connected with the Continuous Linked Settlement (CLS) system to enable payment-versus-payment (PVP) service for foreign exchange settlement involving Korean won. In its early days, BOK-Wire processed fund transfers based solely on its real-time gross settlement (RTGS) mechanism. As the BOK-Wire settlement volume surged, however, liquidity burdens on participants increased. In May 2005, the BOK, therefore, launched a 4-year project to develop a new system (BOK-Wire+), which would use not only the pre-existing RTGS mechanism but a hybrid settlement mechanism⁹ as well. BOK-Wire+ has operated stably since its launch in April 2009. It replaced BOK-Wire, the pure RTGS system which had been in operation since 1994. The key feature of BOK-Wire+ is the introduction of a hybrid system in addition to the previous pure RTGS system. The BOK-Wire+ hybrid system provides bilateral and multilateral offsetting settlements for liquidity savings. BOK also provides intraday overdraft with KRX for settlement of government bond transactions.

BOK-Wire+ settlement procedures are sub-classified into those using the RTGS system and those using the hybrid system with its bilateral and multilateral offsetting features added to the RTGS system. Participants hold two types of accounts with the BOK—current accounts and deposit accounts for settlement. The former are used for transactions carried out through the RTGS system and the latter for those through the hybrid system.

Funds transfers involving BOK loans, government and public bond transactions, CLS and Retail Payment System (RPS) net settlement are handled through the RTGS system, while those related to general funds transfers, call transaction settlements, and DVP settlements are processed through the hybrid system.

Online operating hours of BOK-Wire+ are from 9:00 a.m. to 5:30 p.m. from Monday to Friday. The BOK may extend these hours temporarily if it deems necessary due to error in BOK-Wire+ system, delays or concentrations of fund settlement, or any other unavoidable reasons.

⁹ A hybrid settlement system is a payment system which combines characteristics of RTGS system and netting system by adding bilateral and multilateral offsetting features to the RTGS system.

2. Typical Business Flows

2.1 Delivery-versus-Payment Flow for the Over-the-Counter Market

Please refer to Part 3, Figure E.2 on bond transaction flow for domestic trades on the DVP OTC market.

2.2 Delivery-versus-Payment Flow for the Exchange Market

Please refer to Part 3, Figure E.3 on bond transaction flow for domestic trades on the DVP exchange market.

2.3 Delivery-versus-Payment Flow for Cross-Border Bond Transactions

Please refer to Part 3, Figure E.4 on bond Transaction flow for foreign investors on the DVP OTC market.

2.4 Other Specific Examples of Cross-Border Bond Transactions

Typical examples of cross border transaction flow include inbound transaction by an investor from the United States through a local custodian (KSD) (Figure 5.5) and outbound transaction flow for the Hong Kong market through a global custodian (Figure 5.6), Citibank HK, are illustrated as follows.

Figure 5.5 Sample of Inbound Transactions in the Korea Bond Market

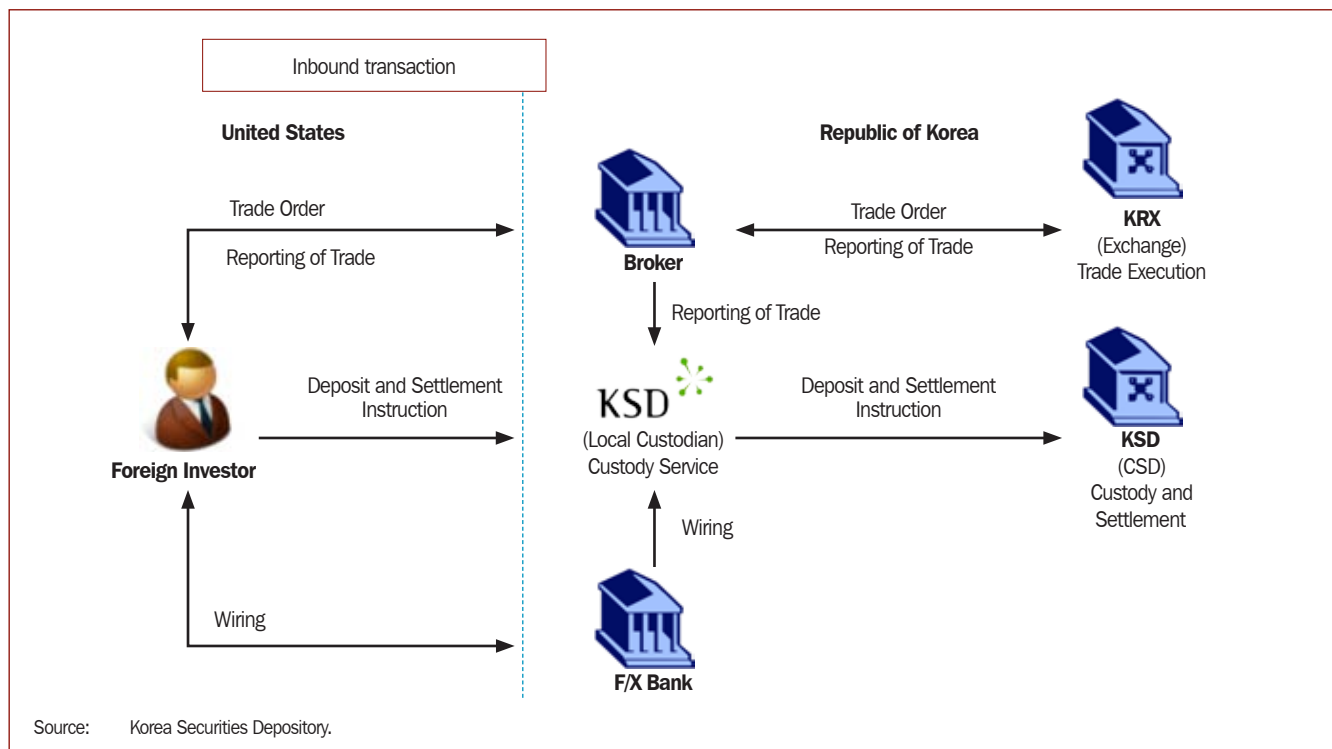
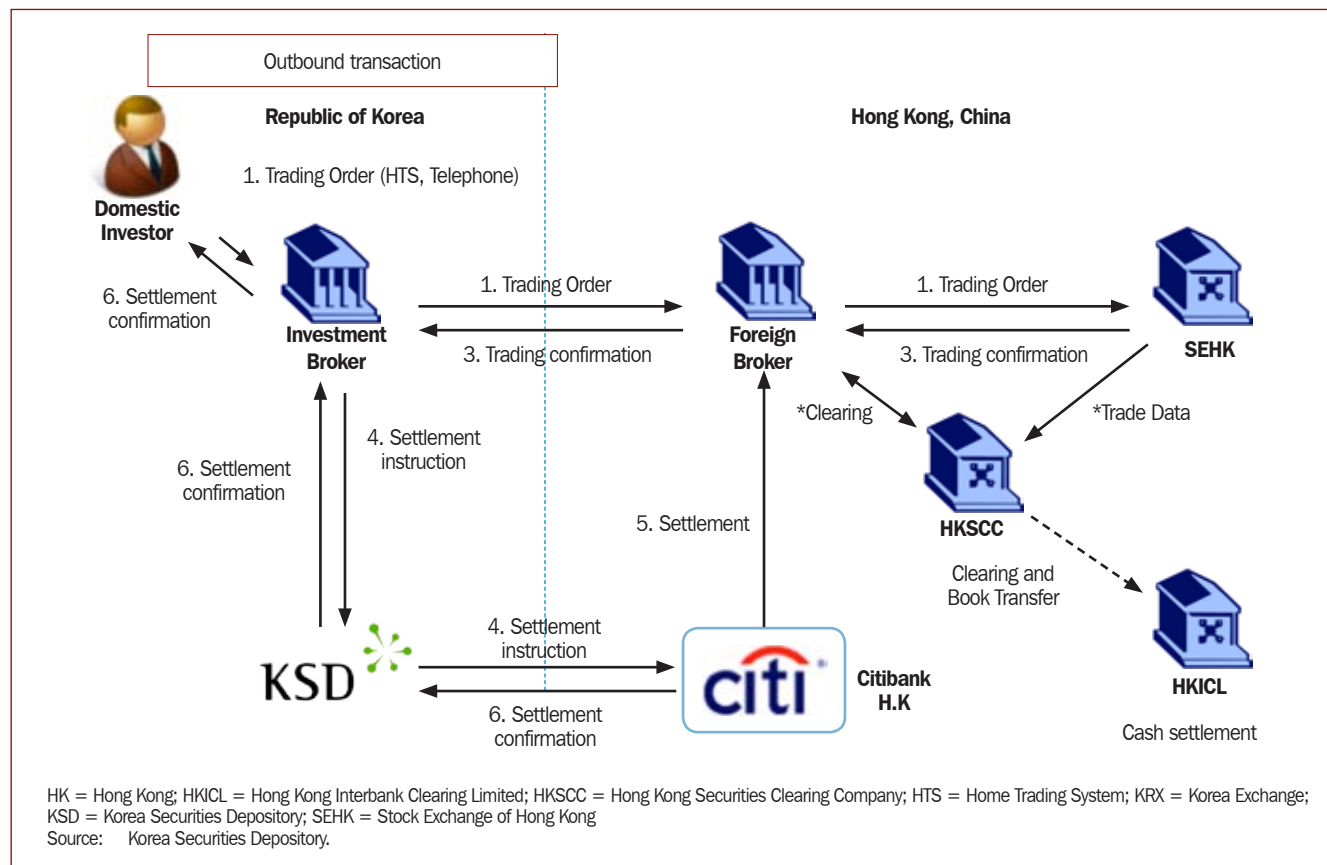

Figure 5.6 Sample of Outbound Transactions in the Korea Bond Market



3. Matching

Both central and local matching facilities are provided to fit each individual case. Central matching is widely used for almost all trades, except for trade funds including members versus its clients who adopt local matching. The seller and buyer send trade data to the KSD and the KSD collates trade data from the seller and buyer. KSD then sends matching status advise to the seller and buyer. Central matching for KRX in the OTC market is illustrated in Figure 5.7 below.

Figure 5.7 Central Matching for Korea Exchange on the Over-the-Counter Market

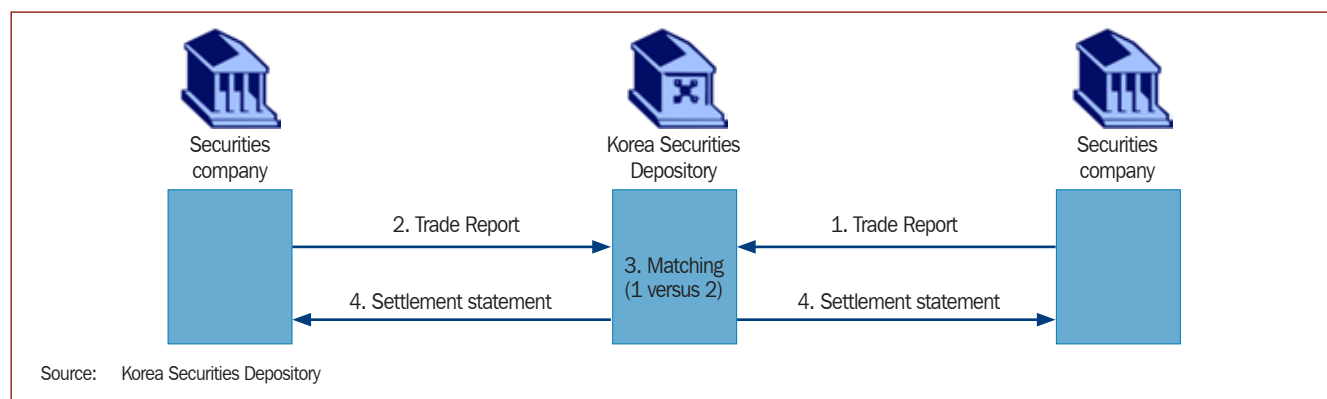
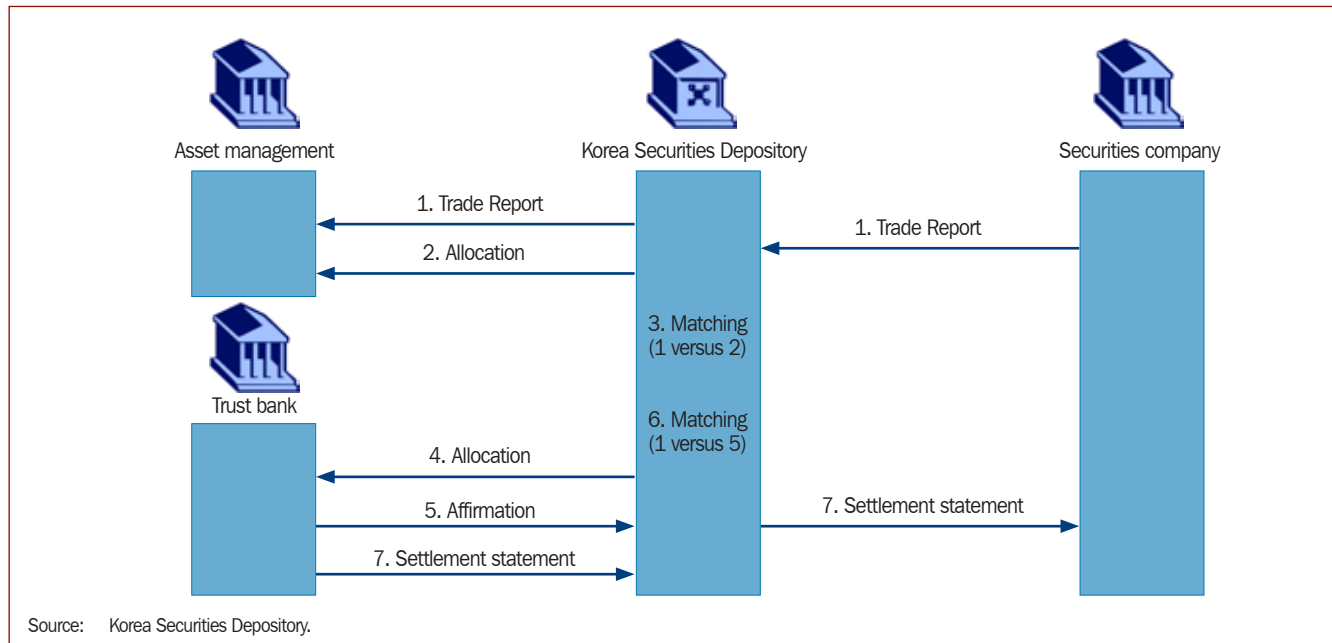

Figure 5.8 Local Matching on Over-the-Counter Market

4. Settlement Cycle

For the OTC market, the settlement cycle is T+1 – T+30. Conventionally, T+1 is adopted to align with exchange trade. The settlement cycle on the OTC market is based on a bilateral contract between counterparties. The settlement cycle of cross-border trades depends on the contract. Usually the settlement cycle of cross-border transaction through Euroclear or Clearstream is T+1 – T+3.

For the exchange market, the settlement cycle is T+1. In case of cross-border trades, the settlement cycle of inbound transaction is T+1. On the other hand, settlement cycle of outbound transaction follows the settlement cycle of the designated country for investment.

5. Numbering and Coding

5.1 Numbering and Coding for the Over-the-Counter Market and Exchange Market

5.1.1 Securities Numbering

The KRX is authorized by the International Standardization Organization (ISO) for securities numbering in Korea. The International Securities Identification Number (ISIN) is adopted as the numbering standard by the KRX. In the domestic market, short code is also used to identify bond name, which is composed of nine digits. The first digit is alphabetic code, which denotes type of security. An example of the first issued Korean Treasury bond in 2006 is shown as follows.

Figure 5.9 Sample of First Issued Korean Treasury Bond in 2006

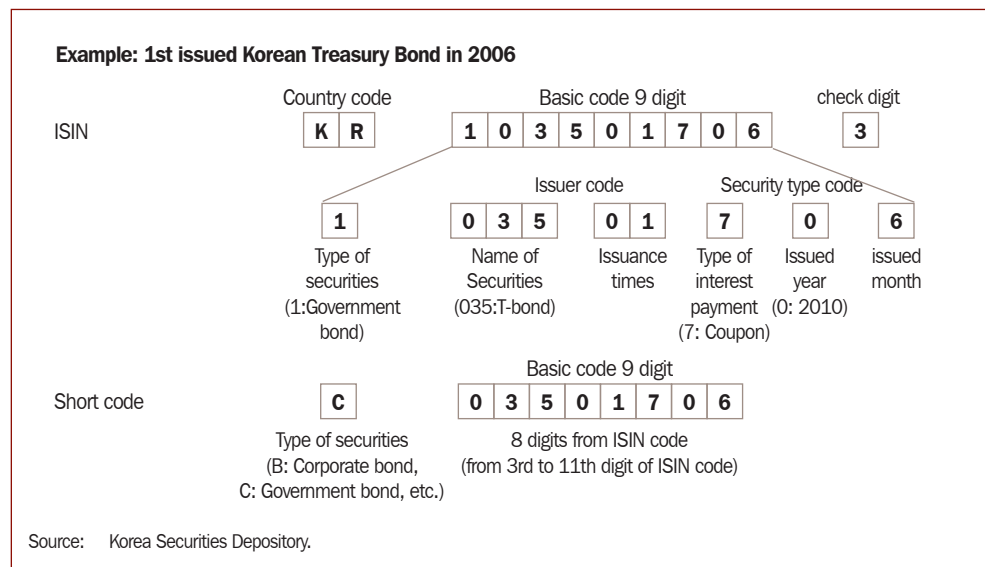

5.1.2 Financial Institution Identification

Each institution such as KSD, the KRX and BOK has proprietary code for each financial entity. KSD uses an account number as an identification number. All of KSD’s participants have one or more account number. The account number has 12 digits. The first six digits mean account holder, the next four digits in the middle mean the purpose of the account, and last digit means securities belongings (proprietary or client’s). KSD’s code structure is illustrated as follows.

Figure 5.10 Korea Securities Depository Code Structure

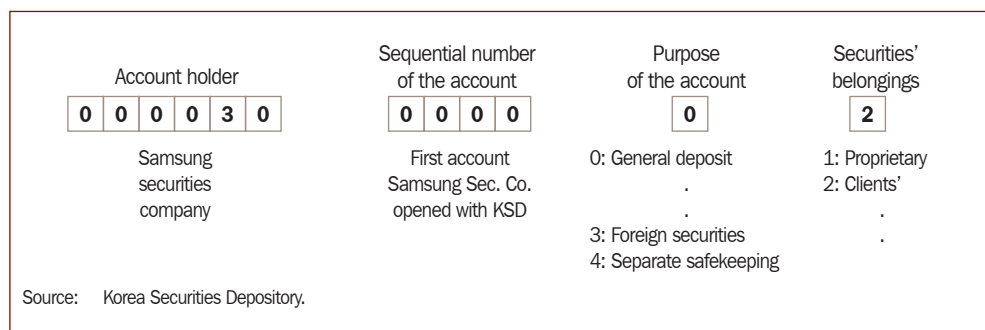

In case of conversion between the Business Identifier Code (BIC) and the local code, mapping the BIC onto local code is executed and vice versa.

5.1.3 Securities Account

A securities account number is used as a financial institution identification code in the KSD.

5.1.4 Cash Account

Proprietary account numbers by the BOK or commercial banks is used for cash accounts. If necessary, mapping the International Bank Account Number (IBAN) into the proprietary code is executed and vice a versa

4.1.5 Character Code and Language

Unicode and UTF-8 are used for character code while Korean is used for bond settlement Infrastructure.

6. Medium- to Long-Term Strategies

KSD was established a new bond settlement system in November 2011 to build a cost-effective Securities Settlement System (SSS) and enhance risk management in the system.

6.1 Background

The domestic bond market has seen a sharp rise in transaction and settlement volumes as a result of heightened market activity since 2006. However, the bond settlement system lacks sufficient improvement to respond to increased transaction and settlement volumes. In particular, chronic settlement delays occur due to lack of compatibility between settlement means of the exchange market and the OTC market (the completion of settlement takes place around 6:00 p.m.). As such, enhancement of the SSS is being pursued to enhance its stability and sharpen its competitive edge.

To resolve the problem of settlement delays in the BOK-Wire+ caused by delays and gridlock in the SSS, the BOK drew up the “Strategy for Upgrading the Securities Settlement System” in November 2009, jointly with the KRX and the KSD. The main elements of this strategy include improvement of the DVP settlement method for greater efficiency in securities settlement, provision by the BOK of intraday liquidity for the settlement of bond transactions, changing of the fund settlement bank for the exchange-traded stock markets, and the introduction of a Continuous Net Settlement (CNS) system. In 2009, KSD, KRX, and BOK formed the Working Group for Securities Settlement System Improvement and concluded the “Agreement on the Securities Settlement System Improvement.” The target date for opening business is in November 2011.

6.2 Highlights of Strategy for Upgrading the Securities Settlement System

1. Improvement of DVP Method
 - Settlement of exchange-traded government bonds: Net settlement by issue for both bonds and funds.
 - Settlement of exchange-traded Repurchase Agreements (RPs): Gross settlement per individual transaction for both securities and funds.
 - Settlement of stock transactions by institutional investors: Net settlement per transaction for securities and per member for funds.
 - Starting time for exchange-traded government bond and stock settlement made progressively earlier.
2. Provision of Intraday Liquidity for Settlement of Government and Other Bonds
 - BOK to provide intraday liquidity to financial investment companies and the KRX for settlement of exchange-traded or OTC bond transactions, including government bonds.
3. Introduction of CNS System in Exchange-traded Stock Markets
 - Securities submitted by settlement deadline (4:00 p.m.) delivered immediately to destined members, and those submitted after deadline netted and settled together with securities settled the following business day.

4. Change of Fund Settlement Bank for Exchange-traded Stock Markets
 - BOK to provide fund settlement services for exchange-traded stock markets from the start of the new system.

6.3 Improvement Measures

Improvement measures of government bond settlement are illustrated in Figures 5.11 and 5.12. These include changing the settlement beginning time and the DVP model, as well as the introduction of DVP model 1 after netting.

Figure 5.11 Basic Structure of Exchange Settlement of Korean Government Bonds

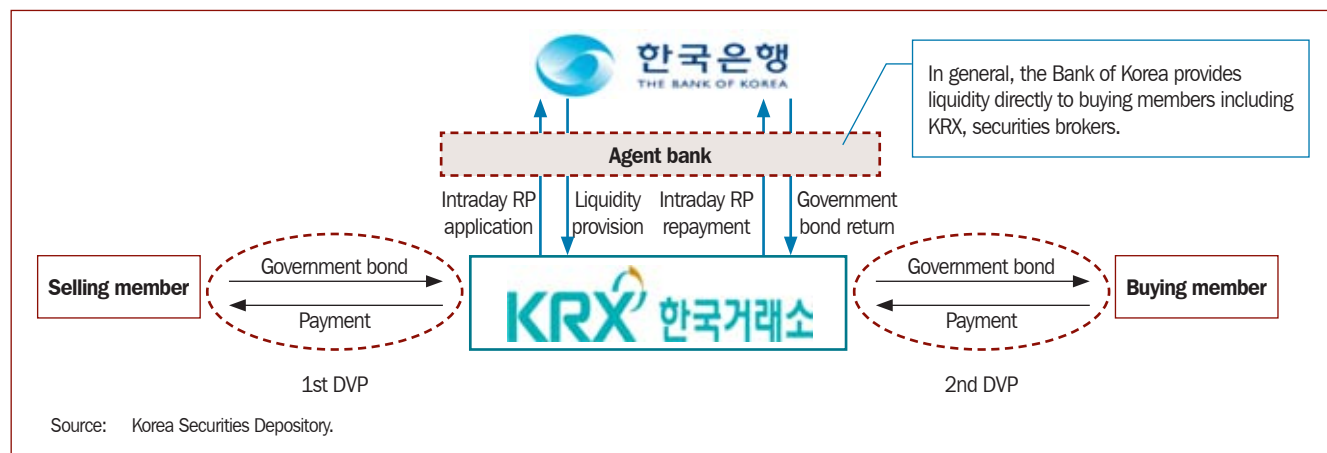

With purchased government bonds under settlement of the BOK as collateral, establishing the intraday RP system to provide liquidity.

Figure 5.12 Basic Structure of Intraday RP System

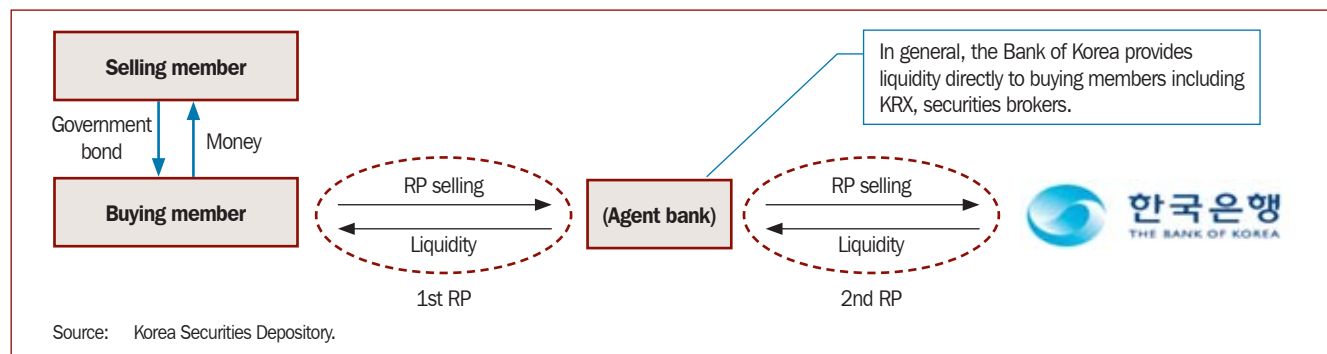

The expected effects of these improvement measures are as follows:

- Enhancement of efficiency in securities settlement
- Enhancement of safety of securities settlement
- Enhancement of convenience of market participants
- Securing global compatibility

Malaysia (MAL)

1. Bond Market Infrastructure

1.1 Overview of Bond Markets

The Malaysian bond market is comprised of the over-the-counter (OTC) market and the exchange market. Unlisted bonds are largely traded on the OTC market while listed bonds are traded through Bursa Malaysia (exchange market). More than 95% of Malaysian bonds are traded on the OTC market. Trade data are entered into the electronic trading platform (ETP), which was launched by Bursa Malaysia in March 2008.

The Real-time Electronic Transfer of Funds and Securities (RENTAS) is the central securities depository (CSD) and real-time gross settlement (RTGS) system for government bond trades in Malaysia. The RENTAS system is comprised of the Scripless Securities Depository System (SSDS), which allows book-entry settlement and recording of holdings of scripless debt securities; and the interbank funds transfer system (IFTS), which deals with large-value fund transfers. It is a delivery-versus-payment (DVP) Model 1 system. Bank Negara Malaysia (BNM) owns and operates RENTAS.

Please refer to Part 3, Figure F.1 for the bond market infrastructure diagram.

1.2 Description of Related Organizations

Bursa Malaysia

Bursa Malaysia is an exchange holding company approved under Sec. 15 of the *Capital Markets and Services Act 2007*. It operates a fully integrated exchange, offering a complete range of exchange-related services including trading, clearing, settlement and depository services.

Bursa Malaysia Securities Clearing Sdn Bhd (BMSC)

BMSC is a wholly-owned subsidiary of Bursa Malaysia with a paid-up capital of MYR300 million and provides clearing and settlement facilities for contracts done between clearing participants. BMSC was incorporated on 12 November 1983 and commenced clearing house operations in March 1984. The BMSC is governed by the BMSC Rules which came into force on 1 January 1997. On 11 November 2002,

BMSC completed the acquisition of Bursa Malaysia Derivatives Clearing Berhad, thus, making it a wholly-owned subsidiary of BMSC.

MyClear

MyClear is an operator of key market infrastructure for the securities market and provides securities and payment services via RENTAS (CSD and RTGS) and the Fully Automated System for Issuing/Tendering (FAST), the issuing system for unlisted debt securities. MyClear was incorporated in October 2008 and commenced operation on 2 January 2009. It was established as a wholly-owned subsidiary of BNM as a separate overseer and operator of the systematically important payment systems. Facilitating cross-border securities payments and settlement is also part of the role of MyClear.

Bursa Malaysia Depository (BMD)

BMD is a subsidiary of Bursa Malaysia and was established in 1990. It is incorporated under the *Companies Act, 1965* and authorized to perform the role of a central depository by the *Securities Industry (Central Depositories) Act, 1991* (SICDA). SICDA provides the legal framework and safeguards for users and participants in the central depository system (CDS).

Bank Negara Malaysia (BNM)

BNM is the central bank of Malaysia. Today, the BNM focuses on the three pillars of the central banking, such as monetary stability, financial stability, and the payment system. In addition, BNM is responsible for the issuance, registration, and settlement and redemption of the government bonds through the in-house automated trading and settlement system. BNM introduced a payment system called the RENTAS system.

1.3 Trading

1.3.1 Over-the-Counter Trading

The Malaysian bond market consists of listed and unlisted bonds. Unlisted bonds are largely traded as the OTC trade. Most trading takes place on the OTC market, where quotes are typically obtained directly from money brokers and dealers over the phone. Financial institutions would either have to be registered or licensed by the Securities Commission of Malaysia (SC) to trade in bonds for their own or their clients' accounts. An agreement concluded over the telephone is then followed up with a confirmation order in writing. An investor can place an order with a dealer at his desired price and amount. However, trade will only be concluded when the dealer can find a corresponding seller in the OTC market.

Financial institutions maintaining their own bond inventories usually provide their market bid or offer prices to their clients. In addition, principal dealers (PDs) are obliged to provide 2-way quotes for benchmark government securities. Information on Government securities and bond indices are also available on the tickers on Bloomberg and Reuters. All trading on the OTC market are reported on the ETP, where the seller of the securities keys in the deal and buyers confirm within the stipulated 10 minutes' cut-off time from trade execution. Normal business hours for a securities trade are as per standard settlement or value spot, i.e., two business days (T+2) from 9:00 a.m. to 4:30 p.m. from Monday to Friday, excluding holidays. Some custodian prefer T+3.

Bursa Malaysia introduced the ETP on 10 March 2008 for the Malaysian bond market in line with the National Bond Market Committee's mandate to develop a single electronic trade reporting and trading platform for the domestic bond market. The ETP is operated by Bursa Malaysia Sdn Bhd, a wholly-owned subsidiary of Bursa Malaysia. ETP was introduced to boost transparency and liquidity, as well as increase efficiency in bond trading. The launch of the ETP is in line with the ongoing commitment to further improve market accessibility and increase trading efficiencies via infrastructure enhancement initiatives. The decision to develop the ETP was made in February 2004 by the National Bond Market Committee, which includes the Ministry of Finance (MoF), SC and BNM.

ETP allows dealers to match bids with offers, negotiate deals, and access historical data through a common computerized network. ETP offers investors real-time price quotation and facilitates the trading and reporting of all secondary market activities.

The key business components that contribute to the business of ETP are:

- Central order book for matching, trade reporting and negotiation
- A comprehensive dissemination system for price per yield and trade information dissemination
- Data storage for market history data referential maintenance for exchange administrator
- A real-time market surveillance system.

The ETP system interfaces with other systems such as the FAST and other information provider (i.e., Bloomberg and Reuters). 100% of volume is done OTC via voice brokers and electronic message. But, for the time being, there is almost no transaction process by ETP.

1.3.2 Exchange Trade

Bonds listed on Bursa Malaysia may be purchased through a dealer who is a member of the exchange, such as investment banks or through remisiers. To trade in listed bonds, investors are required to open a depository account operated by BMD. These accounts are maintained by banks that are members of the exchange, acting as authorized depository agents. The depository account works on the principle of a book-entry system or electronic clearing and settlement, and represents ownership and movement of the listed bonds. Institutional investors may open depository accounts directly with the BMD. Investors need to provide their depository account numbers when buying or selling listed bonds on the exchange. Listed bonds are normally traded in board lots of 1,000 units. Information on prices of listed bonds is readily available on the ETP.

1.4 Central Counterparty Clearing

1.4.1 Central Counterparty Clearing for the Over-the-Counter Market

There are no CCPs in the Malaysian OTC market.

1.4.2 Central Counterparty Clearing for the Exchange Market

BMSC is the clearing house for bond securities traded on the Bursa Malaysia stock exchange. BMSC provides the Bursa Clearing and Settlement System for participants

on the exchange market. The Bursa Clearing and Settlement System electronically connects with the Bursa Trade System and Central Depository System.

1.5 Bond Settlement

1.5.1 Bond Settlement Traded on the Malaysian Over-the-Counter Market

To subscribe to or trade in debt securities, an investor must open an account with an authorized depository institution (ADI). ADIs are licensed financial institutions that are members of RENTAS and are allowed by BNM to hold SSDS securities on behalf of customers that are not members of the SSDS. For members of the SSDS, BNM is the authorized depository, crediting bondholders with scripless bonds for trading and transfers according to the *Code of Conduct and Market Practices for Scripless Trading*, and recording the holdings and transactions of each SSDS member institution. ADIs offer protection to investors with regard to payment of interest and redemption proceeds. They ensure secrecy of accounts, issue statutory acknowledgement receipts and monthly statements detailing account holdings and transfers, and carry out the various responsibilities of depository institutions to their customers. Dealers that act as ADIs maintain two accounts with the SSDS: one for their own holdings, and another for all the securities they hold in custody, through which non-SSDS members' transactions are cleared and settled. ADIs are required to maintain a separate account for each customer.

All securities trades are generally settled based on a delivery-versus-payment (DVP) basis. For all government securities and scripless corporate debt securities, ownership and transfers are reflected as book entries in the ADIs' custody accounts with BNM in RENTAS. For non-RENTAS members, such as institutional investors and other financial institutions, scripless securities can be transacted via their ADIs. Cash payments of coupons, as well as redemption proceeds, will be forwarded to investors via their respective ADIs.

The settlement of the primary and secondary market transactions in government securities and unlisted corporate debt securities take place through the SSDS, which is part of RENTAS. RENTAS, established by BNM in 1999, comprises the IFTS, which deals with large-value fund transfers, and the SSDS, which allows the book-entry settlement and recording of holdings of scripless debt securities. A sale or purchase of securities between two parties involves a book-entry and intraday settlement of funds in the cash settlement account maintained with BNM. RENTAS, which has straight-through-processing (STP) capability, will process, transfer and settle interbank funds and scripless transactions simultaneously in real time. It is a DVP Model 1 system, i.e., securities and funds settled gross throughout the day.

RENTAS contributes to the reduction of settlement risk in scripless securities transactions by providing a mechanism for DVP. This mechanism would enable transfer instructions for both scripless securities and funds to be effected on a trade-by-trade basis, with final (unconditional) transfer of the securities from the seller to the buyer (delivery) occurring at the same time as the final transfer of the funds from the buyer to the seller (payment). RENTAS utilizes the Corporate Information Superhighway (COINS), which is a nationwide, broadband network which supports multiprotocol and multimedia applications provided by Syarikat

Telekom Malaysia Berhad as the communication network to link up participating financial institutions.

1.5.2 Bond Settlement Traded on the Exchange Market

BMD operates the Central Depository System (CDS) which has created a scripless trading platform for trading bonds. CDS facilitates electronic securities transfer and trade settlement, and uses the book-entry form of recording ownership and movement of securities. BMD has been offering omnibus accounts since 2005.

1.6 Cash Settlement

The RENTAS IFTS is an RTGS system for the transfer and settlement of high-value ringgit-denominated interbank funds and scripless securities transactions. RENTAS IFTS enables payment instructions between participants of the system to be processed and settled individually and continuously throughout the working day. All settled transactions are considered as final and irrevocable. Thus, the receiver can use the funds immediately without being exposed to the risk of the funds not being settled. This is in contrast to the former system, Sistem Pemindahan Elektronik Dana dan Sekuriti (SPEEDS), which was a deferred net settlement system, where payments were processed throughout the working day, but actual entries across the books of BNM were only effected at the end of the day. RENTAS IFTS, being an RTGS system, can substantially reduce or eliminate settlement exposures for participants of the system. Besides reducing the settlement risk for interbank funds transfers, RENTAS IFTS can help reduce the risks in exchange for value settlement systems such as those for securities settlements. The system has the capacity to handle higher volume of transactions compared to the SPEEDS System, and incorporates better security features through the use of smart cards for authentication and transmission. Provision had also been made for international linkages to facilitate real-time DVP and real-time payment versus payment (PVP) should this need arise in the future.

Intraday credit is permitted in the market, and may depend on intermediaries' assessment of client standing. Overdraft is also available, for technical reasons (e.g., time-zone differences) for up to 2 business days; and requires advised credit line (or prefunding arrangement).

2. Typical Business Flows

2.1 Delivery-versus-Payment Flow in the Malaysian Over-the-Counter Market

Please refer to Part 3, Figure F.2 on the bond transaction flow for domestic trades in the OTC market (DVP).

2.2 DVP flow for Cross-Border Bond Transactions

Please refer to Part 3, Figure F.3 on the bond transaction flow for foreign investors in the OTC market (DVP).

Scripless securities, including Malaysian government securities and selected debt securities, can also be settled internationally via major global custodian banks and international central securities depositories (ICSDs), such as Euroclear and Clearstream. Both these ICSDs currently appoint selected ADIs, which are clearing

members of RENTAS, as their clearing agents in Malaysia. Non-residents or offshore investors may also individually appoint ADIs that are RENTAS members as custodians of their investments. Most financial institutions are also members of the Society for Worldwide Interbank Financial Telecommunication (SWIFT), which facilitates the efficient transmission and confirmation of cross-border payment and settlement instructions in foreign currencies.

3. Matching

3.1 Over-the-Counter Market

RENTAS provides local matching. The seller (or buyer) initiates unconfirmed settlement advice in RENTAS. The buyer (or seller) then confirms an unconfirmed settlement advice using the confirmation menu of RENTAS, concluding the local matching process. After confirmation, the seller and buyer can access the confirmation report in RENTAS.

3.2 Exchange Market

A central matching facility will be implemented in the fourth quarter of 2011 and expected to cover only bonds traded on the exchange, and settlement at BMD through the Institutional Settlement Service (ISS)¹⁰ mode.

4. Settlement Cycle

From an infrastructure viewpoint, same-day settlement is available in the Malaysia bond market. Standard settlement cycle is T+1/T+2 from a market practice point of view for domestic transactions. For cross-border transactions, settlement cycle is generally T+2. But, some players adopt T+3.

5. Numbering and Coding

5.1 Numbering and Coding for Over-the-Counter Market and Exchange Market

5.1.1 Securities Numbering

International Securities Identification Number (ISIN) is used for securities numbering, but local securities codes prevail.

5.1.2 Financial Institution Identification

The Business Identifier Code (BIC) is used as part of a unique identifier code (UIC) for the participants.

5.1.3 Securities Account

The Securities Account Structure in RENTAS-SSDS is illustrated in Figure 6.1. Each participant has a primary securities account, a collateral account, as well as an unlimited number of optional customer sub-accounts.

¹⁰ ISS is a service compliant with the Bank of International Settlement (BIS) DvP Model 2. BMSC acts as a CCP and guarantees payment and settlement.

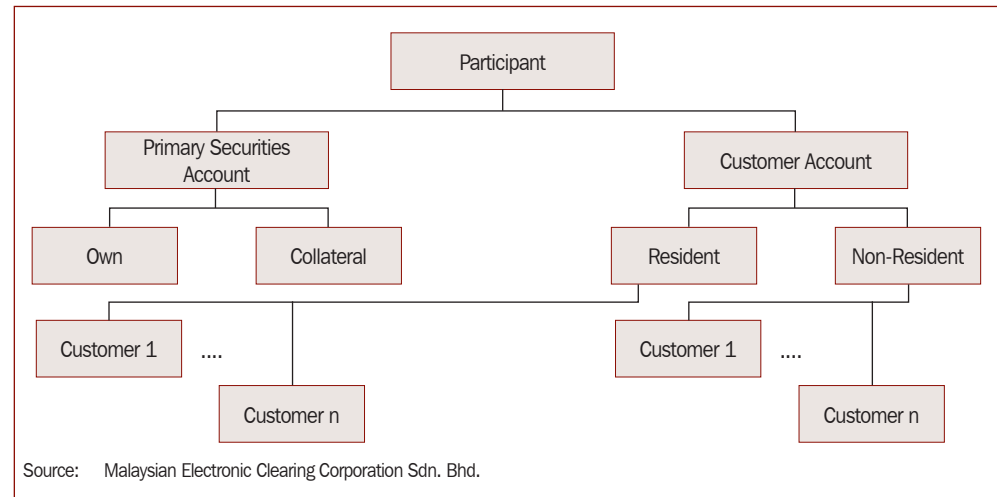
Figure 6.1 Securities Account Structure in RENTAS

5.1.4 Cash Account

The Cash Account Structure in RENTAS-IFTS is illustrated in Figure 6.2. Every participant has a primary settlement account, a statutory reserves account, as well as an unlimited number of optional sub-accounts.

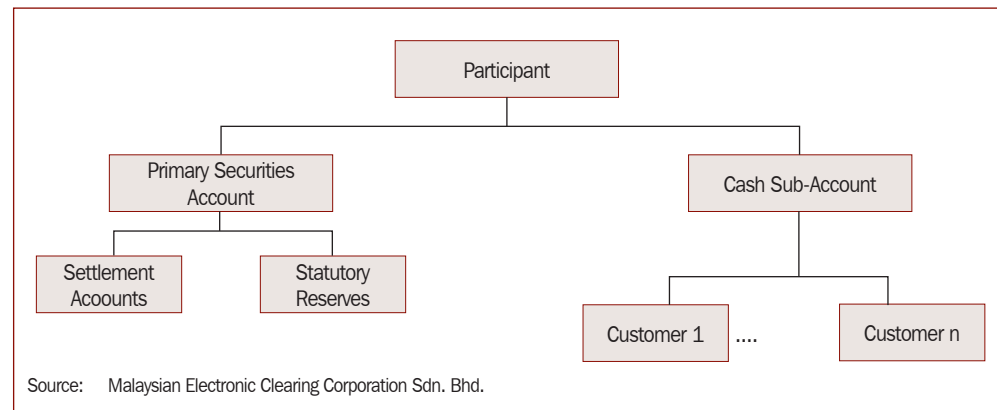
Figure 6.2 Cash Account Structure in RENTAS

5.1.5 Character Code and Language

Unicode UTF-8 is adopted. The language used for payment and settlement system is English.

6. Medium- to Long-Term Strategy

BM itself will soon access RENTAS directly. An initiative called the Common Platform Model for Asian Post-Trade Processing Infrastructure is underway, which is a cooperation between BM and the Hong Kong Monetary Authority.

Philippines

(PHI)

1. Bond Market Infrastructure

1.1 Overview of Bond Markets

The Philippine bond market is comprised of the over-the-counter (OTC) market and the exchange market. According to OTC rules in Philippines, secondary trading of government and corporate bonds must be conducted through self-regulatory organizations (SROs). Therefore, trading participants of the markets should be members of an SRO. To date, the Philippines Dealing and Exchange Corporation (PDEX) is the only SRO in Philippines, and almost all transactions of bonds take place in with PDEX. It operates the Fixed Income (FI) Trading System, which includes two types of trading platform for debt securities: the Negotiated Dealing Platform and the Auto Match Platform. The Negotiated Dealing Platform is primarily for professional markets with relatively large trading transactions while the Auto Match Platform caters to the public market (through broker participants) with smaller volume.

The Bureau of Treasury (BTr) is the central securities depository (CSD) for government bonds (Treasury bills and Treasury bonds). BTr owns and operates the Registry of Scripless Securities (BTr-RoSS), which is the official registry of absolute ownership, legal or beneficial titles or interest in government bonds. Hence, all government bond transactions are finally settled in BTr-RoSS. The Philippines Depository and Trust Corporation (PDTC) is the CSD for corporate bonds. It also acts as a sub-registry for government bonds in some cases.

After the trade is executed in the FI Trading System, the trade data is sent to BTr-RoSS via PDEX-RoSS straight-through processing (STP) facility or the electronic delivery-versus-payment (eDvP) System. The FI Trading System automatically chooses the system used for the settlement process—either through the PDEX-RoSS STP Facility or the eDvP System—according to the parties involved in a trade.

The PDEX-RoSS STP Facility is for government securities eligible dealers (GSEDs) and transmits trade data directly to BTr-RoSS. The eDvP System is for non-GSEDs and transmits trade data to PDTC.

The cash settlement is performed on Philippine Payment and Settlement System (PhilPaSS), which is owned and operated by the Bangko Sentral ng Pilipinas (BSP). When trading participants do not have an account with BSP, other settlement banks will be involved.

Please refer to Part 3, Figure G.1 for the bond market infrastructure diagram.

1.2 Description of Related Organizations

Philippine Dealing and Exchange Corporation (PDEX)

PDEX is licensed by the Securities and Exchange Commission (SEC) as an exchange under the provisions of the *Securities Regulation Code* (SRC). PDEX is an operating subsidiary of the Philippine Dealing System Holdings Corporation (PDS Group).

Bureau of Treasury (BTr)

BTr is the CSD for government securities (Treasury bills and government bonds), and owns and operates the BTr-RoSS.

Philippine Depository and Trust Corporation (PDTC)

PDTC was founded as the CSD in the Philippines bond market in 1995. It is owned by the PDS Group. PDTC provides depository and settlement services for equities, such as common shares that may be classified as A and B, preferred shares, warrants, and depository receipts, commercial papers, private bonds, and government securities.

Bangko Sentral ng Pilipinas (BSP)

BSP is the central bank of the Republic of the Philippines. It was established on 3 July 1993. It provides the PhilPaSS and acts as a cash settlement entity in the bond market.

1.3 Trading

1.3.1 Over-the-Counter Market

In March 2005, the Fixed Income Exchange (FIE) was established in the Philippines. FIE is operated by PDEX, which is tasked to operate and maintain the trading system for fixed-income securities and its derivatives. It runs the FI Trading System (Negotiated Dealing Platform). Its member brokers and dealers are only allowed to engage in OTC transactions. When a seller and a buyer arrange or negotiate a trade outside the FIE, they have to execute the trade on the FI Trading System within 1 minute from conclusion of negotiation.

Traders can communicate, negotiate and deal transactions from their respective offices, and the system ensures that all information sent to each transacting party is kept confidential and cannot be viewed by the public.

1.3.2 Exchange Market

In February 2008, PDEX launched the Auto Match Dealing Platform where broking participants can post orders received from retail investors. With this platform, retail investors are given equal access to the various fixed income securities listed on the trading board. The transactions on this platform are captured automatically and broadcast on real-time basis.

1.4 Central Counterparty Clearing

1.4.1 Central Counterparty Clearing for the Over-the-Counter Market

There is no CCP for the OTC market.

1.4.2 Central Counterparty Clearing for the Exchange Market

There is no CCP for the exchange market.

1.5 Bond Settlement

1.5.1 Bond Settlement at the Bureau of Treasury-Registry of Scripless Securities

The Bureau of Treasury (BTr) is the CSD for government securities. BTr established the BTr-RoSS for depository and settlement of government securities in November 1996. BTr-RoSS settles transactions in delivery-versus-payment (DVP) Model 1 under the Bank of International Settlement (BIS) definition. BTr-RoSS checks the securities in the seller's securities account and earmarks these for transfer. After the cash settlement is processed, BTr-RoSS will transfer the earmarked securities from the seller's securities account to the buyer's.

The settlement process in Philippine bond market is varied according to the kinds of trade participants as the following figures show. The settlement process for government bond trades where both parties are GSEDs is shown as follows.

Figure 7.1 Settlement through RoSS-PhilPaSS DVP

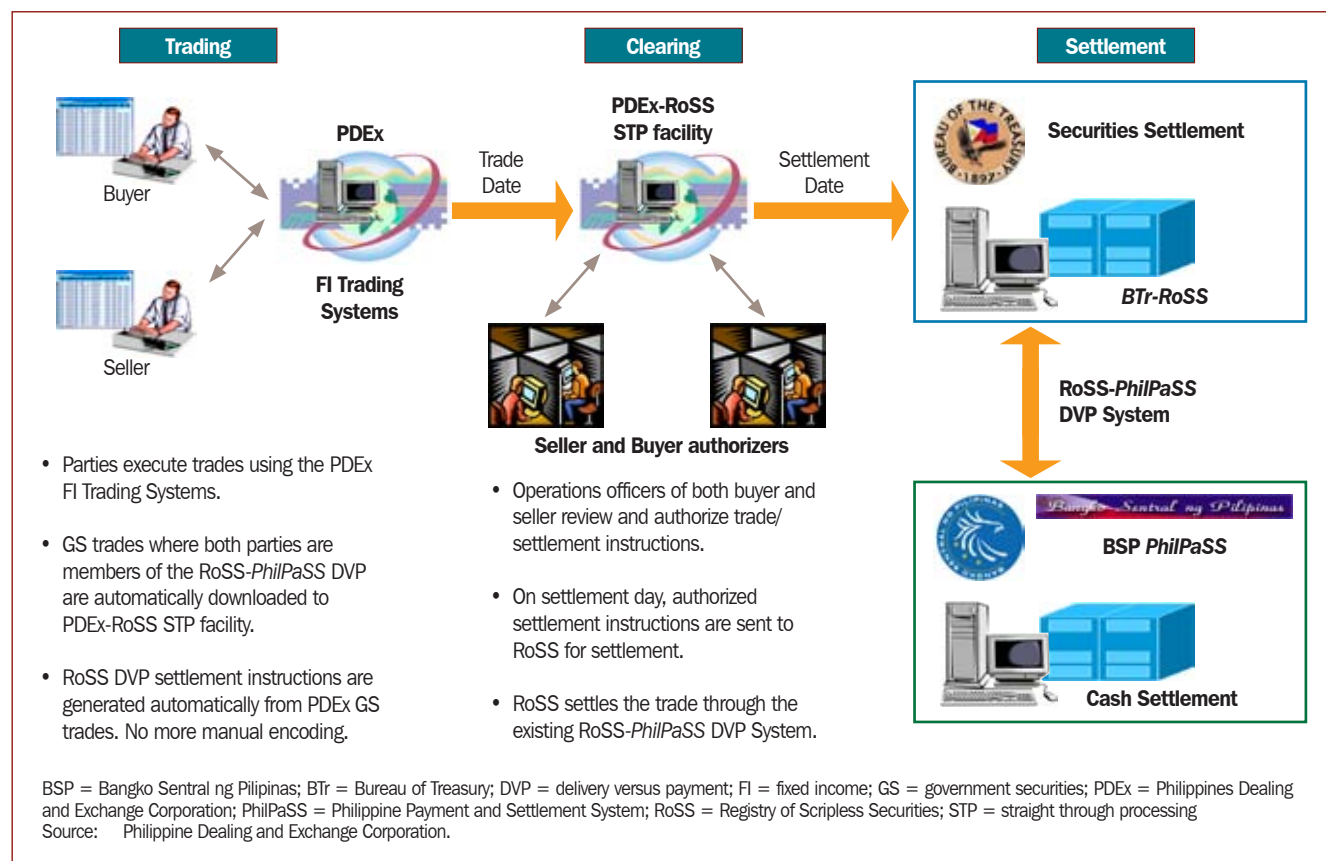

The settlement process for all corporate bond trades and government bond trades where one or both parties are non-GSED is shown as follows.

Figure 7.2 Settlement Process for Corporate Bond Trades and Government Bond Trades

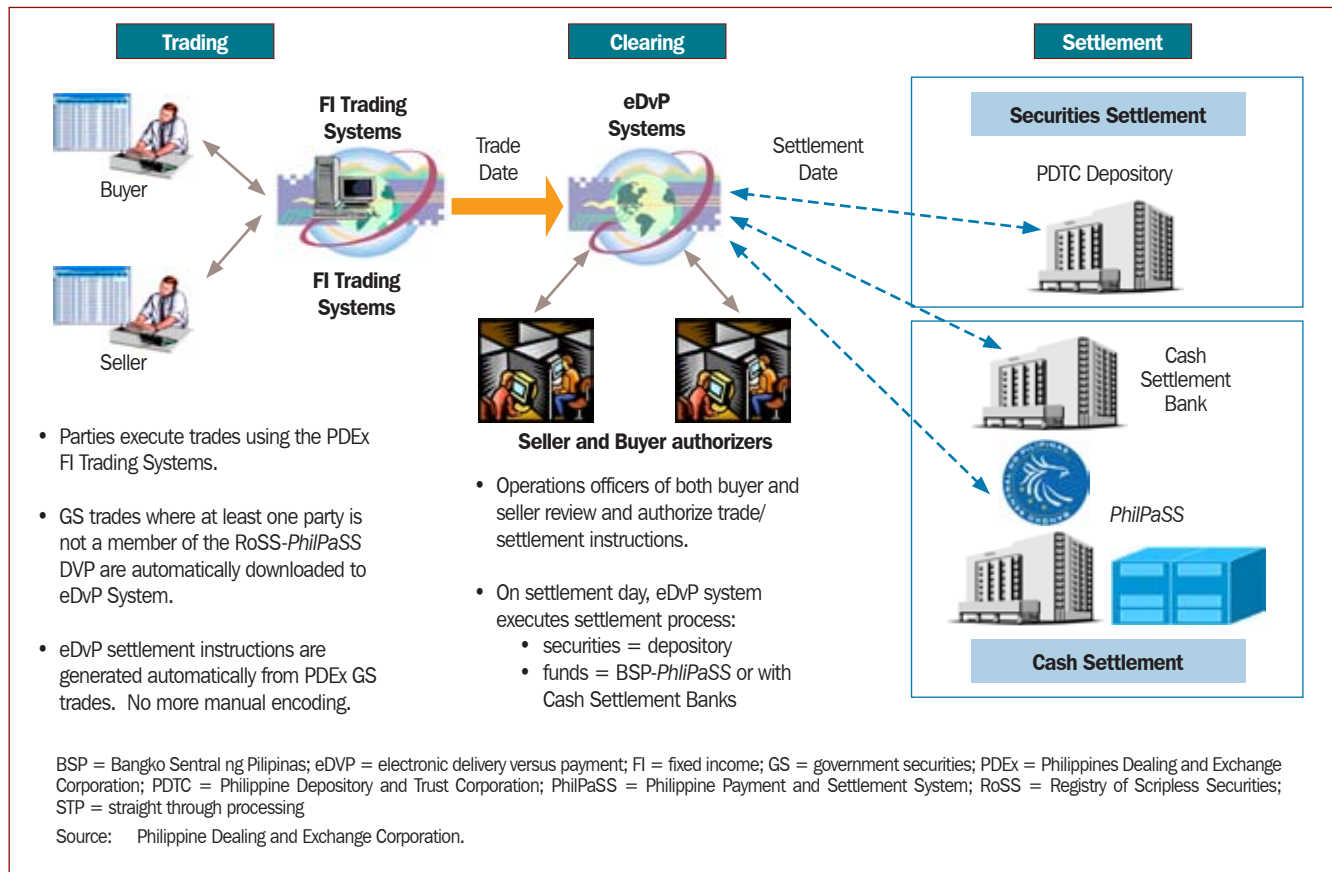

1.5.2 Bond Settlement on the Philippine Depository and Trust Corporation

For corporate bonds and non-dealer government securities trades, the PDTC provides depository and settlement services as a CSD. PDTC adopts the DVP Model 1 under BIS definition. The proprietary network without specific name is used and the types of lines are Internet and point-to-point leased line. The protocol used is Hypertext Transfer Protocol Secure (HTTPS). The interface is browser-based, e.g., Internet Explorer, and the message format is proprietary.

1.6 Cash Settlement

1.6.1 Cash Settlement Using Central Bank

Trade between GSEDs is settled by a central bank account. BSP provides the Philippines's real-time gross settlement (RTGS) system, which is called PhilPaSS. All GSEDs have their accounts of BTr-RoSS for bond settlement and accounts of BSP PhilPaSS for cash settlement. In this case, the RoSS-PhilPaSS DVP system sends settlement data to BSP-PhilPaSS. Cash settlement is made through the debit or credit of the GSEDs accounts. BSP also provides an intraday overdraft facility.

1.6.2 Cash Settlement using Cash Settlement Bank

When one or both parties of trade are non-GSEDs, and both do not have a BSP account, the trade is settled with a cash settlement bank.

2. Typical Business Flows

2.1 Delivery-Versus-Payment Flow for the Over-the-Counter Market (Government Securities Eligible Dealers)

Please refer to Part 3, Figure G.2 on the bond transaction flow for domestic trades in the GSEDs market (DVP).

2.2 Delivery-Versus-Payment Flow for the Over-the-Counter Market (Including Non-Government Securities Eligible Dealers)

Please refer to Part 3, Figure G.3 on the bond transaction flow for domestic trades in the non-GSEDs market (DVP).

2.3 Delivery-Versus-Payment Flow for Cross-Border Trade

The domestic leg settlement is handled like any other domestic trade, with the foreign investor represented locally by a custodian or a dealer trading participant. The process of delivery to or collection from the foreign investor is bilaterally arranged but all modes entail foreign exchange registration with the central bank.

Transaction cost for cross-border clients can range from \$15 to \$30, which covers both cash and securities transactions and the Bangko Sentral Registration Document (BSRD) processing, reporting and monitoring. Redemption is treated as a free-of-payment (FOP) transaction. The transaction and account maintenance fees should generally cover all services. There would also be an account maintenance fee which ranges from 1.5 basis points (bps) to 3 bps per annum based on future value (FV) and inclusive of depository fees and taxes.

Please refer to Part 3, Figure G.6 on bond transaction flow for foreign investors in the OTC market (DVP).

3. Matching

The seller and buyer send instructions to PDEX and PDEX, through the FI Trading System, matches order from the seller and the buyer. PDEX, through the PDEX-RoSS STP Facility sends settlement data to BTr-RoSS. PDEX FI trades are already matched when sent to the clearing system for DVP settlement. PDEX operates a post-trade clearing facility, with STP from the trading systems, for counterparties to confirm their settlement obligations prior to settlement. Therefore, CSD matching is used only for non-exchange trades. The depository provides both local and central matching capabilities either for inputting or uploading of transactions. Local matching is applicable only to FOP transactions while DVP instructions are used in central matching.

4. Settlement Cycle

All PDEX trades settle on a DVP basis typically on a T+1 settlement cycle for domestic transactions. For cross-border transactions, the settlement cycle depends on the custodians involved. The most prevailing settlement cycle may be T+3 for cross-border transactions. FOP transactions are settled in real-time mode upon execution and confirmation of transfer instructions either at the registry or at the depository.

5. Numbering and Coding

5.1 Numbering and Coding for the Over-the-Counter and Exchange Markets

5.1.1 Securities Numbering

The International Securities Identification Number (ISIN) is used for government securities, except for special purpose Treasury bonds and multi-currency retail Treasury Bonds. Local numbering is also used for most of bond transactions.

5.1.2 Financial Institution Identification

Both Business Identifier Code (BIC) and local code are used. PDS-assigned firm codes are used to identify the financial institution in its trading, depository and settlement systems. However, mapping tables are used to convert these codes to their BIC equivalents when PDS systems interact with central bank or cash settlement bank systems.

5.1.3 Securities Account

The securities account is in text format and using ISO 20022.

5.1.4 Cash Account

The BIC code of the bank and the regular bank account number are used to identify cash accounts.

5.1.5 Character Code and Language

UTF 8 is used for all the trading, depository and settlement systems. The language for payment and settlement is English.

6. Medium- to Long-Term Strategies

The PDS Group and regulators (BSP and SEC) are very conscious about promoting STP whenever possible. While there is no official initiative tasked to implement STP, each financial institution plans to mitigate risks and reduce operational costs. They are promoting STP in the following areas:

- Between trading system and the back-office systems of trading participants
- From trading systems to the clearing and settlement systems
- Between depository system and the back-office systems of depository participants
- Between the depository and the registry systems both for government and corporate bonds

- Between the depository or registry systems and the settlement bank systems for linkages with other depositories

Each institution implements STP using proprietary conventions. For example, interfaces to settlement banks' deposit systems are governed by each bank's proprietary solution. This results in the feeder institution (such as the depository) having to customize the interface for each settlement bank which it connects to. The development of specific interface program for each connectivity point translates to multiple development and maintenance cost and increased operational risk. It is applicable that an industry-wide initiative streamlines STP connectivity requirements and promotes to use a centralized infrastructure (such as an STP "hub"). Regulators could set deadlines for companies to be ISO 20022 compliant.

Singapore (SIN)

1. Bond Market Infrastructure

1.1 Overview of Bond Markets

Singapore's bond market is comprised of the over-the-counter (OTC) market and the exchange market. Singapore government securities (SGS) are traded on the OTC market, whereas corporate bonds are mainly traded on the Singapore Exchange (SGX), too. Settlement of SGS is performed via the Monetary Authority of Singapore (MAS) Electronic Payment System plus (MEPS+) SGS, and settlement of corporate bond is performed via the Debt Securities Clearing and Settlement System (DCSS). MEPS+ real-time gross settlement (RTGS) has a cash settlement function of full range of bonds.

Please refer to Part 3, Figure H.1 for the bond market infrastructure diagram.

1.2 Description of Related Organizations

The Monetary Authority of Singapore (MAS)

MAS is the central bank of Singapore, which acts as the agent for the Government of Singapore in issuing SGS that comprise of Treasury bills (T-bills) and government bonds. It provides overall supervision of the financial industry, including the securities industry, and operates a bond settlement and registry system (MEPS+ SGS) to facilitate the trading of Singaporean government debt. The book-entry system (MEPS+ SGS) is linked to the MEPS+ RTGS.

The Singapore Exchange (SGX)

SGX is a self-regulating organization governed by its own rules and by-laws, but ultimately supervised by the MAS. SGX was formed on 1 December 1999 as a holding company of some former exchange companies such as the Stock Exchange of Singapore (SES), Singapore International Monetary Exchange (Simex), and the Securities Clearing and Computer Services Pte. Ltd. (SCCS). The Tokyo Stock Exchange Group, Inc. holds about 4% of the stock while SGX holds a 20% stake in the Philippine Dealing System Holdings Corporation (PDS Group), which has become an associated company of SGX.

The Central Depository (Pte.) Limited (CDP)

CDP, which was established in 1980 and commenced operations in 1987, is wholly owned by the SGX. Settlement through the CDP is compulsory for all transactions of listed securities. The CDP, through its DCSS, is the depository for eligible private sector debt. DCSS-eligible securities are restricted to new, Singapore dollar-denominated private sector debt issues. The CDP provides clearing functions for corporate bonds, derivatives, and equities.

1.3 Trading

1.3.1 Over-the-Counter Markets

SGS are mainly traded in the OTC market. All trade confirmations for SGS are performed through the MEPS+ SGS. The seller keys in all the trade detail into MEPS+ SGS, which is then affirmed by the buyer. The buyer and seller have an option to choose either delivery-versus-payment (DVP) or free-of-payment (FOP) based settlement (most of them settled by DVP) in the MEPS+ SGS. As SGS are in the scripless form, ownership and transfer of SGS are reflected as book entries in the bank's custody account with MAS.

Corporate and statutory bonds are also traded in the OTC market. Transactions are cleared and settled through the online DCSS.

1.3.2 Exchange Markets

Bonds which are listed are traded on the SGX. The corporate bond market in Singapore is regulated by the SGX. Corporate bonds are traded on the Bond Quotation System of the SGX. The trading system of SGX links directly with DCSS, which is operated by the CDP. Taking effect beginning 8 July 2011, investors can trade SGS bonds in the secondary market on the SGX.

1.4 Central Counterparty Clearing

There is no central counterparty clearing (CCP) function for the OTC and exchange bond markets.

1.5 Bond Settlement

1.5.1 Bond Settlement on the Over-the-Counter Market

SGS are settled via book-entry movements within participant accounts at the MAS. Trade instructions are submitted by the delivering party and receiving counterparty to MEPS+ SGS by 5:30 p.m. on settlement day (SD). Upon matching, securities and cash are transferred between participants on a simultaneous, trade-by-trade basis. Settlement is completed on T+3 against MEPS+ payment.

The MEPS+ SGS system holds government bonds and facilitates the instantaneous and irrevocable transfer of SGS. It is linked to the MEPS+ RTGS system to provide DVP for SGS transactions. Under the scripless settlement system, crediting or debiting the securities owner's account through the book-entry system effects any transfer of securities. Most of SGS transactions are settled through DVP over MEPS+ SGS and MEPS+ RTGS.

If the seller of SGS has insufficient SGS for delivery, the transaction is queued in MEPS+ SGS until sufficient SGS is made available in the seller’s SGS account. When the seller’s SGS account has sufficient SGS, the SGS is earmarked for transfer to the buying bank, and a payment instruction is sent to MEPS+ RTGS for funds settlement.

1.5.2 Bond Settlement on the Exchange Market

The DCSS is an electronic book-entry system and a facility for clearing and settlement of transactions in the OTC market in Singapore dollar-denominated private debt securities. It is operated by the CDP, which is a depository and a designated clearing house. Transactions can be settled on a DVP or FOP basis. Exchange-listed corporate debt securities are mostly settled on a DVP basis. CDP does not act as the central counterparty for such trades, and no netting is carried out. Both the buyer and seller input the settlement instruction, containing key details of the trade into the DCSS. Upon matching of the settlement instructions, the seller’s debt securities are earmarked and the transaction proceeds to settlement. Matched instruction can only be revoked by the buyer.

For DVP settlement, transactions are settled on a real-time basis. Funds are transferred via MEPS+, and securities are simultaneously transferred via the DCSS book-entry system on a gross trade-for-trade basis. The real-time DVP arrangement is achieved through a live leased-line link between DCSS and MEPS+. For FOP settlement, transacting parties use CDP only for securities transfer and arrange for funds transfer separately.

The transaction flow of DCSS is illustrated below.

Figure 8.1 Transaction Flow of Debt Securities Clearing and Settlement System

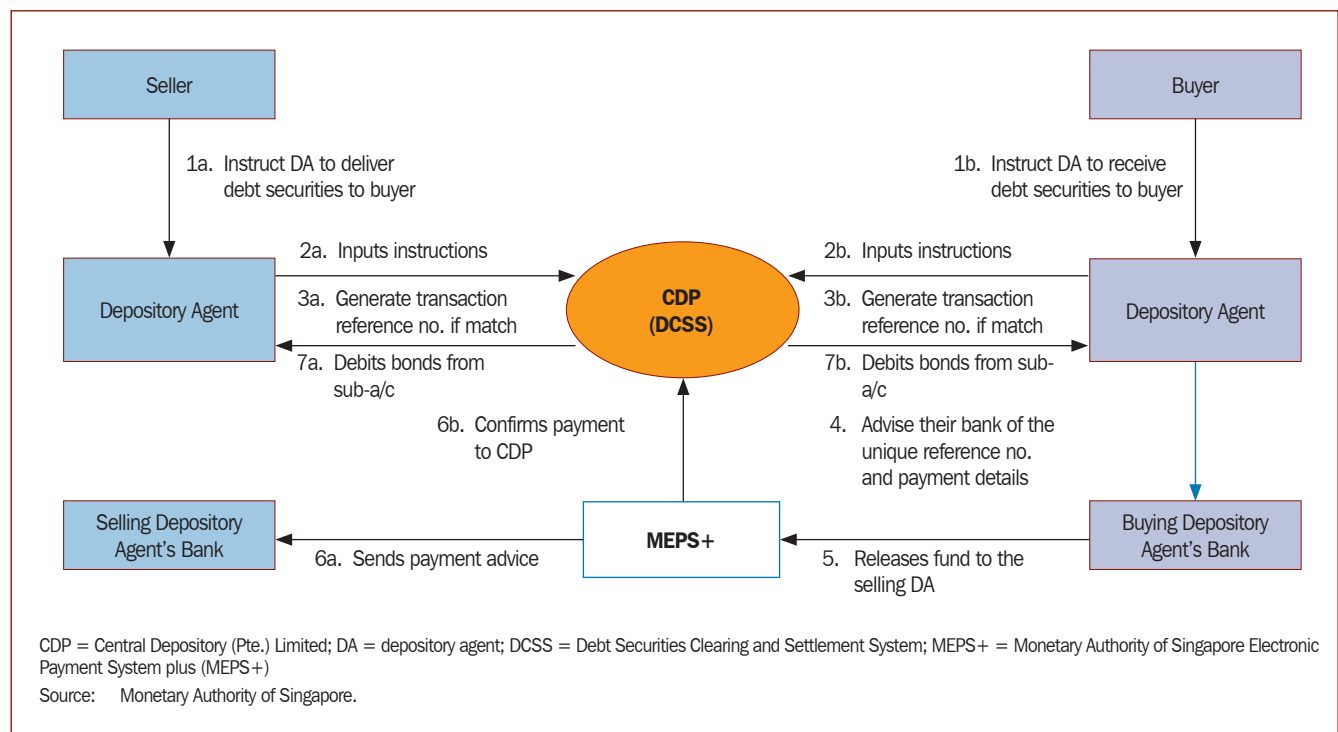

1.6 Cash Settlement

All types of bonds utilize MEPS+ RTGS for cash settlement. MEPS+ RTGS and MEPS+ SGS are directly linked for cash settlement of SGS. If the buying bank has insufficient funds to pay for the SGS purchase, the payment is queued in the MEPS+ RTGS. When the funds become available, the amount is debited from the buyer's RTGS account and credited to the seller's RTGS account. The MEPS+ RTGS simultaneously notifies the MEPS+ SGS to transfer the securities to the buyer.

Cash settlements for corporate bond trades also occur in MEPS+ RTGS. Funds are transferred via MEPS+ RTGS while securities are simultaneously transferred via the DCSS book-entry system on a gross trade-by-trade basis. A real-time DVP arrangement is achieved through a live leased-line linkage between DCSS and MEPS+ RTGS.

2. Typical Business Flows

2.1 Delivery-versus-Payment Flow for the Singapore Over-the-Counter Market

Please refer to Part 3, Figure H.2 for the bond transaction flow for domestic trades on the OTC market (DVP).

2.2 Delivery-versus-Payment Flow for Cross-Border Bond Transactions

Please refer to Part 3, Figure H.3 the bond transaction flow for foreign investors on the OTC market (DVP).

3. Matching

For SGS transactions from the OTC market, MEPS+ SGS provides local matching. The seller or buyer enters trade data to the MEPS+ SGS system. The system then transmits the data to the counterparty. If the data are correct, the counter party sends them back to the MEPS+ SGS for affirmation. Then, the SGS transactions are regarded as matched.

4. Settlement Cycle

The settlement cycle of SGS and corporate bonds is can be T+1, but is commonly contracted at T+3.

5. Numbering and Coding

5.1 Numbering and Coding for the Over-the-Counter Market and Exchange Market

5.1.1 Securities Numbering

The International Securities Identification Number (ISIN) is used in the Singapore bond market.

5.1.2 Financial Institution Identification

MEPS+ SGS and MEPS+ RTGS adopt the Society for Worldwide Interbank Financial Telecommunication (SWIFT) Business Identifier Code (BIC) to identify financial institutions. MEPS+ SGS and MEPS+ RTGS non-participant member code can either use its SWIFT BIC or an eight-character code assigned by MAS.

5.1.3 Securities Account

Securities account uses proprietary numbering. There are three types of SGS accounts in MEPS+ SGS—SGS Reserve account, SGS Trade account, and SGS Customer account.

SGS-Reserve Account

Banks would deposit SGS for compliance with the Minimum Liquid Assets (MLA) requirement to hold at least 10% of the qualifying liabilities (QL) in SGS at all times in this account prior to the start of the 2-week maintenance period. Banks may not sell SGS in the SGS-MLA account directly. To give banks the flexibility to manage their holdings of SGS issues, transfers of SGS holdings between the SGS-Reserve account and the SGS-Trade account can be made at any time when the MEPS+ SGS is in operation, subject to the 7:00-p.m. deadline for same-day transfers. Transfers of SGS holdings out of the SGS-Reserve account to the SGS-Trade account are permitted only if the remaining value of SGS holdings in the SGS-Reserve account after the transfer is at least 10% of QL. Transfers to or from the SGS-Reserve account will not be queued for settlement, i.e., if there is insufficient securities in the account (either SGS-Trade or SGS-Reserve accounts) to be transferred out, and the transaction will be rejected.

SGS-Trade Account

SGS holdings in excess of the minimum 10% MLA requirement may be deposited in the SGS-Trade account. SGS holdings in this account can be used for trading.

SGS Customer Account

Primary and approved SGS dealers maintain an additional SGS Customer account for the SGS holdings of their customers. Holdings in a Customer account can be transferred FOP to the bank's SGS holdings, or to another bank's or its customer's SGS holdings. Purchases or sales on delivery against payment of SGS holdings in a bank customer's account from and/or to another bank or its customer's SGS holdings can also be transacted.

5.1.4 Cash Account

Cash account uses proprietary numbering.

Participants are required to maintain current account with MAS. Banks' intraday Minimum Cash Balance (MCB) requirement, if any, is maintained in the Current Account.

Funds in the Current Account exceeding the intraday MCB requirement are transferred at the start of the day to the participant's RTGS account in MEPS+ RTGS, where they may be used for the settlement of interbank payments.

5.1.5 Character Code and Language

UTF-8 (Unicode) is adopted and English is chosen as a standard language for payment systems in Singapore.

Thailand (THA)

1. Bond Market Infrastructure

1.1 Overview of Bond Markets

The Thai bond market is composed of the over-the-counter (OTC) market and the exchange market. Unlisted bonds are largely traded under the OTC market while listed bonds are traded through the Stock Exchange of Thailand (SET). More than 95% of bonds are traded in the OTC market. Traded data are entered into Post-Trade Integration (PTI) and settled using the PTI, which is the book-entry system of bonds in Thailand. PTI is owned and operated by SET and shared by the Thailand Clearing House (TCH) and the Thailand Securities Depository (TSD), which are subsidiaries of the SET. Cash settlement is effected through the Bank of Thailand Automated High-Value Transfer Network (BAHTNET) which is the RTGS system owned, operated and regulated by the Bank of Thailand (BOT).

Please refer to Part 3, Figure I.1 for the bond market infrastructure diagram.

1.2 Description of Related Organizations

The Stock Exchange of Thailand (SET)

SET is the stock exchange of Thailand and was established with the enactment of a legislation passed in May 1974. On 30 April 1975, the SET officially started trading. On 1 January 1991, its name was formally changed to “The Stock Exchange of Thailand” (SET).

The Bond Electronic Exchange (BEX)

BEX is a subsidiary of SET and was launched on 26 November 2003. BEX’s main role is to support the secondary market for bond trading. As majority of bond trading are in the OTC market, therefore, BEX’s objective is to expand bond activities to individual investors.

The Thai Bond Market Association (BMA)

BMA is a securities business related association under the *Securities and Exchange Commission Act B.E. 2535*. Its main purposes are to be a self-regulatory organization (SRO) for a fair and efficient operation of the bond market and to be an information center for the Thai bond market. As a pricing agency, BMA provides Thai bond prices

to Bloomberg and Reuters; in return, it receives trade details via Bloomberg's FIRST online capture. The BOT stipulates that every bond dealer has to be BMA member.

The Thailand Clearing House Co. Ltd. (TCH)

TCH, a subsidiary of SET, was established on 9 August 2004, with a registered capital of THB100 million. During 2004–2009, TCH acted as a clearinghouse or a center for clearing derivatives traded in the Thailand Futures Exchange (TFEX). Through the clearing house integration plan and intention to segregate risk associated with clearinghouse role from depository function, the TSD, which had acted as clearinghouse for equity and bond since 1 January 1995, has transferred clearing and settlement functions for equity and bond to TCH from 2010 onwards. Thus, TCH will become the integrated clearing house for all financial products. The TCH is governed by the *Securities and Exchange Act B.E. 2535 (1992)* for equity and bond, and the *Derivatives Act B.E. 2546 (2003)* for derivatives. It is under the supervision of the Securities and Exchange Commission (SEC).

The Thailand Securities Depository Co., Ltd. (TSD)

TSD is a subsidiary of SET and was established on 16 November 1994. TSD is the sole central securities depository (CSD) in Thailand using a scripless system.

The Bank of Thailand (BOT)

The BOT was first set up as the Thai National Banking Bureau. The *Bank of Thailand Act* was promulgated on 28 April 1942 vesting upon the BOT the responsibility for all central banking functions. The BOT started operations on 10 December 1942. It developed an electronic large-value funds transfer, known as BAHTNET. It is designed to mitigate risk in payment systems to facilitate settlement in effective, secured and timely manner on real-time gross settlement (RTGS) basis since 24 May 1995.

1.3 Trading

1.3.1 Over-the-Counter Markets

Most trading takes place on the OTC market, where quotes are typically obtained directly from money brokers and dealers over the phone. An agreement concluded over the telephone is then followed up with a confirmation order in writing. An investor can place an order with a dealer at his desired price and amount. However, the trade is concluded when the dealer can find a corresponding seller in the OTC market.

Dealers have to report trade details to the BMA, as the pricing authority, within 30 minutes. BMA publishes trade reports for government securities upon receipt and twice daily for corporate bond trades.

1.3.2 Exchange Markets

Trading Fixed Income Instruments on the Exchange

BEX was established to provide investors with additional investment instruments. In addition to a better access to information for investors, BEX will also provide investors with an ease to conduct trading transactions. BEX enhances the bond's secondary market. Prior to BEX, bonds were traded on the OTC market, which was mainly the institutional investor's arena. Small investors were unable to get into that particular market due to its size and its ambiguity, or simply the lack of information.

BEX is currently working under the trade-by-price method. However, the committed price will be converted into indicative yield to assist in decision making. The commission fee associated with bond trading required by brokerage companies is not fixed and subject to negotiation between the investors and their respective brokers. Dealers have to report trades to the BMA within 30 minutes in similar ways on the OTC market.

1.4 Central Counterparty Clearing

1.4.1 Central Counterparty Clearing for the Over-the-Counter Market

There is no clearing function for the OTC bond market.

1.4.2 Central Counterparty Clearing for the Exchange Market

TSD administers clearing and settlement process. Currently, it takes 2 working days to complete the clearing and settlement transaction once the order has been executed. To simplify the procedure, investors are encouraged to make scrip deposit to TSD prior to any deal taking place. Right after a trading transaction is matched and those exchanges have confirmed the matching transactions with their members, the TCH, as the direct central counterparty (CCP), will become a buyer to every selling member and a seller to every buying member. Therefore, a member who has bought or sold the securities has an obligation not to the party on the other side of the transaction, but to the clearinghouse, just as the clearinghouse has an obligation to the member. This is called a novation process.

As a CCP, TCH guarantees the performance of payment and securities delivery of any trading transactions on SET (BEX). This reduces the risks stemming from clearing members who fail to meet their contractual obligations or 'credit risks', thereby strengthening the confidence in and by the involved parties, as well as preserving the financial integrity of the clearinghouse and the market as a whole. However, the TCH does not guarantee the payment and securities delivery for gross settlement transaction.

The role of the TCH is illustrated as follows.

Figure 9.1 Role of the Thailand Clearing House

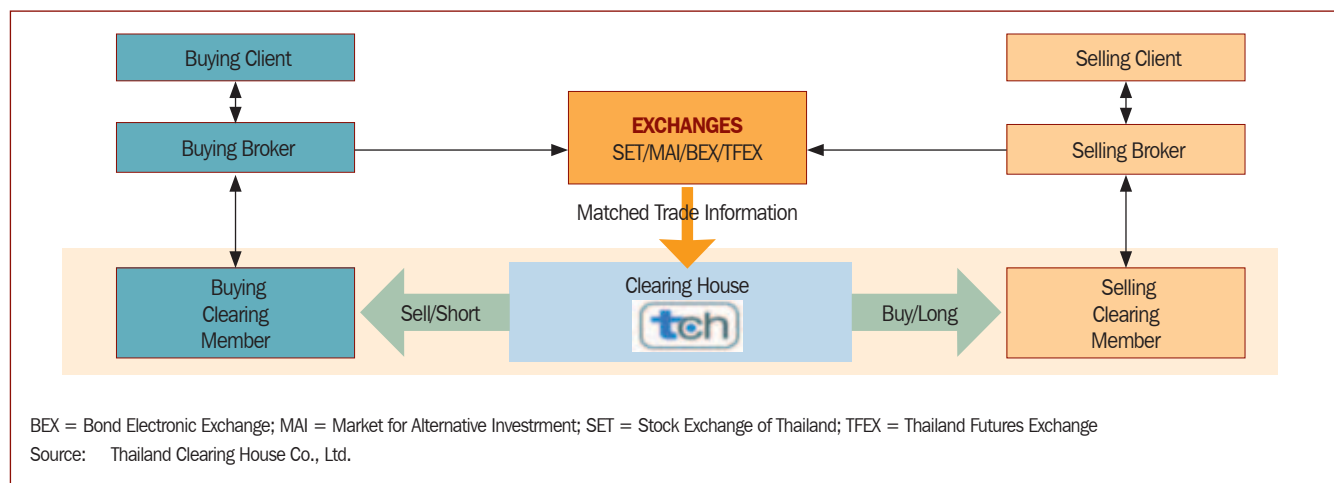

1.5 Bond Settlement

Bonds are settled via the PTI system on the RTGS basis. The buyer and seller send the settlement instructions to PTI. Once they are matched, TCH sends the instruction to TSD to withhold the bonds in the seller’s account. TSD also sends the instruction to the BOT to settle the money. After the money settlement is completed, TSD transfers the bond from the seller’s account to buyer’s account.

PTI as core system combines settlement-depository-registration functions and features. PTI allows for STP, integrates with BAHTNET, and includes FOP transactions. PTI’s messaging is based on Society for Worldwide Interbank Financial Telecommunication (SWIFT) messages. PTI uses the International Securities Identification Number (ISIN) and Business Identifier Code (BIC), but a converter exists to local codes. Participants can utilize web-based capture, and uploading is possible. Each market participant must have PTI terminals. A PTI system is a standalone system, with no interface with market participants’ systems.

Figure 9.2 Process for Gross Settlement for DVP

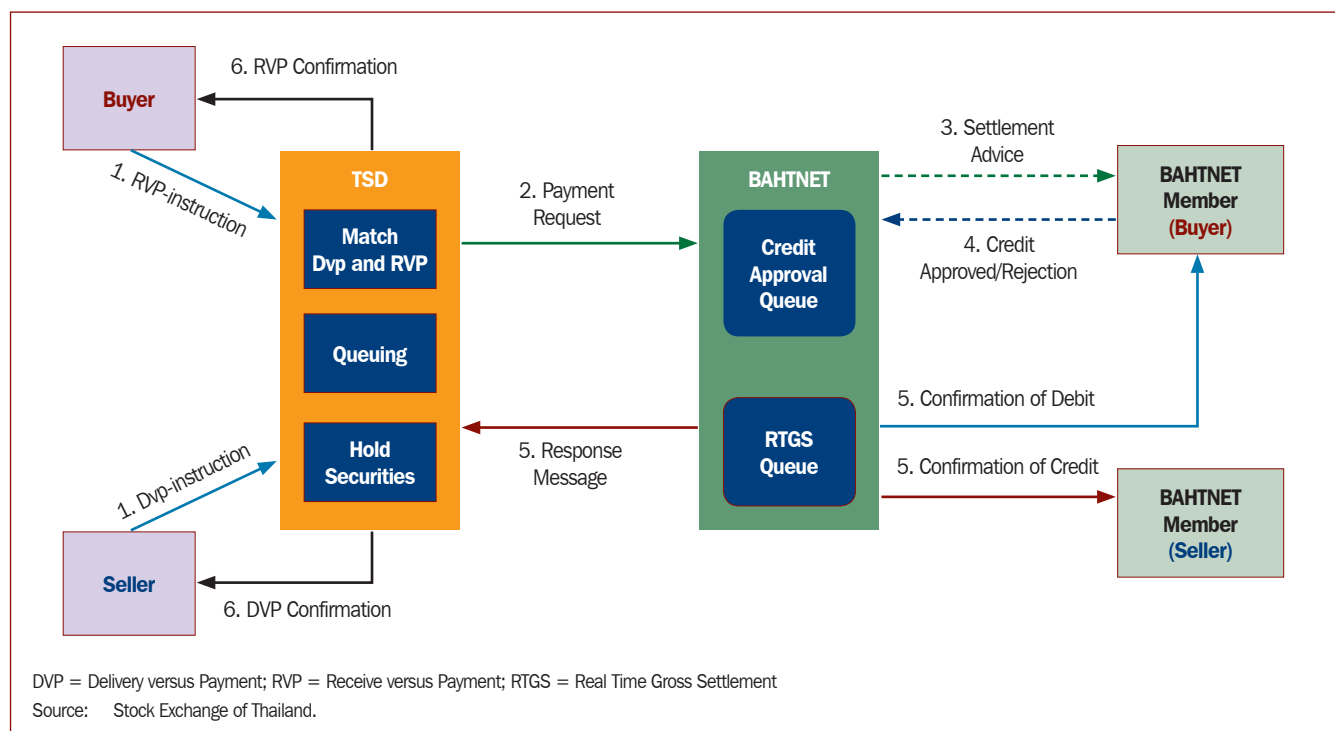

1.6 Cash Settlement

Cash settlement uses BAHTNET. BAHTNET is an irrevocable funds transfer system, which operates on RTGS basis. BAHTNET is linked with TSD’s system to facilitate delivery versus payment (DVP) for government securities. Intraday Liquidity Facility (ILF), which provides intraday overdraft, is available for the BAHTNET members under BOT supervision. BAHTNET also provides a quieting mechanism and gridlock resolution system to provide adequate liquidity for cash settlement. As a high-value payment system, BAHTNET has implemented sufficient level of security measures such as digital signature based on private keys and smart cards to secure integrity, confidentiality, authentication, and non-repudiation including

audit trail. Regarding foreign exchange control, currently, non-residents can open two types of Baht accounts with commercial banks: Non-resident Baht Account for Securities (NRBS) and Non-resident Baht Account (NRBA). NRBS must be used for investment in securities and other financial instruments in Thailand (such as equity instruments, debt instruments, unit trusts, and exchange traded derivatives), as well as any payments relating to such investment (e.g., tax payment relating to securities investment, brokerage fee, and custodian fee). NRBA is for general purposes other than those of NRBS. Outstanding balances of each type of account at the end of each day shall not exceed the limit of THB300 million per non-resident, which includes balances of all accounts opened by each non-resident with all financial institutions in Thailand.

2. Typical Business Flows

2.1 Delivery-versus-Payment Transaction Flow for Domestic Trade in the Over-the-Counter Market

Please refer to Part 3, Figure I.2 for the bond transaction flow for domestic trades in the OTC market (DVP).

2.2 DVP Transaction Flow for Cross-border Trade

Please refer to Part 3, Figure I.3 for the bond transaction flow for foreign investors in the OTC market (DVP).

3. Matching

The automatic matching system for settlement transaction is used. The system checks if the DVP instruction can be matched with other receive-versus-payment (RVP) instructions according to the pre-specified matching fields. The PTI system already uses central (two-side trade input) matching. This method is preferable as market participants can input the instructions to the system in advance and the system matches automatically with the specified date. In addition, most of participants in bond settlement are banks which already use SWIFT messages so they can forward the instructions to the system without having to re-key in.

4. Settlement Cycle

Although the bond settlement system can be on real-time basis, most of market participants settle bond on T+2. In addition, bond trading in BEX is also settled on T+2. In the case of an investor from the United States, the settlement cycle is T+3.

5. Numbering and Coding

5.1 Numbering and Coding for the Over-the-Counter Market

5.1.1 Securities Numbering

ISIN is used for bond trade but, local numbering is also used.

5.1.2 Financial Institution Identification

BIC code is used for financial institution identification. However, proprietary code is also used.

5.1.3 Securities Account

ISO 20022 is not adopted in Thai bond market. The settlement system uses proprietary account numbers to transfer the bond.

5.1.4 Cash Account

The International Bank Account Number (IBAN) is not used. Since market participants are banks and the fund is settled via the BOT system, participants then use the BOT account number as reference to transfer funds.

5.1.5 Character Code and Language

SWIFT format is used as the character code for bond and cash instructions. English is adopted as the standard language for payment systems.¹¹

6. Medium- to Long-Term Strategy

Currently, STP is already implemented for bond transactions. Most of the bonds are traded on the OTC market. After entering to the PTI of TCH, traded data are processed automatically without significant manual intervention, except necessary affirmation. As such, domestic bond settlement process is sufficiently automated. Regarding cross-border trade, messages are compliant with ISO 15022 and have high potentiality to be processed with less manual intervention of custodians. Adoption of ISIN and BIC may have some advantage to be directly connected with other CSDs in the near future.

In the very near future, both government and corporate bonds will be listed on the BEX. While, currently, only publicly listed companies' bonds are allowed to trade on BEX, non-listed companies will soon be able to have their bonds traded on the exchange as well. However, there is no electronic trading platform for the Thailand bond market. In 2010, BMA signed a multilateral memorandum of understanding with four key authorities namely, the BOT, the Public Debt Management Office, and the SET and Securities and Exchange Commission to establish the Thailand Financial Instruments Information Center (TFIIC), an infrastructure project under the Capital Market Development Master Plan 2009–2014. The TFIIC will centralize storage of financial instruments data and information for public access and cross-agency sharing within domestic financial markets.

¹¹ SWIFT format is based on UTF-8.

Viet Nam (VIE)

1. Bond Market Infrastructure

1.1 Overview of Bond Markets

In Viet Nam there are two bond markets which are the over-the-counter (OTC) market and the stock exchange market. Most of the bonds are firstly traded on the OTC market bilaterally by phone or some other measures similar to other countries in ASEAN+3. All traded data are entered into the stock exchanges. There are two stock exchanges in Viet Nam: the Hanoi Stock Exchange (HNX) and the Hochiminh Stock Exchange (HOSE). HNX was established in 2005 and started handling government bonds in 2009. All traded government bonds are entered into HNX since then. Unlisted bonds are also traded on the OTC market though the trading volume and value are very small compared to those of listed bonds. As such almost all bonds are entered to the stock exchanges. Government bonds (government bond, government-guaranteed bond, and municipal bond) and foreign currency-denominated bonds traded in the Specialized Government Bond Market are processed and operated at the HNX. Corporate bonds listed on HNX and HOSE are dealt on the two exchanges.

The definition of trade date in Viet Nam is different from other ASEAN+3 markets. In Viet Nam, the date traded data are entered to the HNX is regarded as the trade date instead of the date when the bond is actually traded and agreed upon by phone or some other measures. As such, the standard settlement cycle in the Viet Nam bond market is T+1 according to proprietary practices. This means settlement cycle T+2 or T+3 is in accordance with standard market practice.

The Vietnam Securities Depository (VSD) is the central securities depository (CSD) for all bonds listed in the HNX and HOSE. Bond transactions are cleared by VSD and VSD is in charge of bond delivery and the Bank for Investment Development of Vietnam (BIDV) is in charge of fund transfer (cash settlement) using delivery versus payment (DVP) subject to the clearing result sent by VSD.

Please refer to Part 3, Figure J.1 for the bond market infrastructure diagram.

1.2 Description of Related Organizations

Hanoi Stock Exchange (HNX)

HNX is a government-owned and -operated exchange under the oversight of the State Securities Commission (SSC). HNX serves as the secondary market for fixed income in Viet Nam (focusing on government bonds, government-guaranteed bonds and municipal bonds). In September 2009 HNX launched a specialized market to trade in government bonds. Innovations in the new market include a system of Internet-based database that will be updated frequently, as well as quoting of both prices and yields of bond trades.

Hochiminh Stock Exchange (HOSE)

HOSE is a government-owned and -operated exchange under the oversight of the SSC. HOSE serves as the secondary market for fixed income in Viet Nam (focusing on municipal bonds and corporate bonds). In June 2008, all government bonds with maturity dates of at least 6 months in the future were moved from HOSE to HNX.

Vietnam Securities Depository (VSD)

VSD provides depository services and depository memberships to local market participants. According to the *Securities Law*, VSD was established on 27 July 2005 as the sole agent providing support services to complete transactions on the Viet Nam securities market. It commenced operations in May 2006. It is headquartered in Ha Noi, with a branch in Ho Chi Minh City. Both branches serve as depositories for securities traded on the respective exchanges in the two cities. Securities are immobilized at the VSD and participant positions are updated via book entry. On 18 December 2008, VSD was re-organized from a state income-generating service delivery agency into a wholly state-owned company. Under the new structure, the VSD is a limited liabilities company which is 100% owned by the MOF and continues to be responsible for monitoring securities registration, deposit, and settlement. The accounts at the VSD are omnibus accounts under the names of depository members.

Bank for Investment and development of Vietnam (BIDV)

BIDV is the oldest commercial bank in Vietnam. BIDV has been designated as a settlement bank for cash settlement for the cash market. All market members are required to maintain a cash account with the designated clearing bank for cash settlement of trades.

1.3 Trading

The seller and the buyer execute bond trades via direct negotiation methods in the stock exchange market. After trading, participants input manually the trading data into the system of the HNX or HOSE. After trade matching, the system of stock exchanges sends the transaction result to the system of the VSD.

1.4 Central Counterparty Clearing

There is no central counterparty clearing (CCP) on the Vietnam OTC bond market.

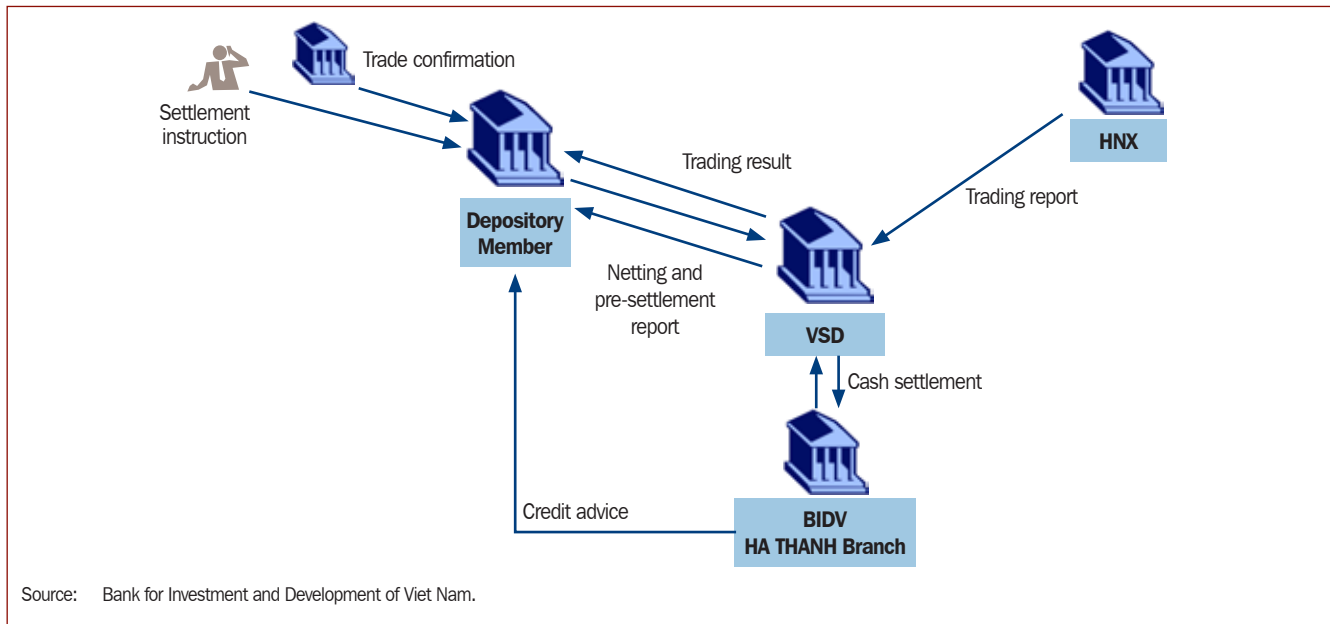
Figure 10.1 Bond Settlement Process in the Viet Nam Bond Market

1.5 Bond Settlement

After receiving transaction results from the exchange markets, VSD performs confirmation between trading parties, netting and conduct settlement processes. Settlement is considered irrevocable after the market deadline, and it becomes obligatory to settle the trades. If the seller or buyer neither affirms nor disputes the trades, it is deemed to have been affirmed by default and such trades are included in its settlement obligations. In fact, VSD sends transaction settlement data to BIDV in the form of files. The software system of VSD and BIDV are independent and do not have a link to each other.

The Bank of International Settlement (BIS) Model 3¹² and Model 1 (for US dollar bonds) are applied in the Viet Nam bond market. Proprietary network without a specific name is used. The types of lines are leased line, Internet Protocol-Virtual Private Network (IP-VPN), and Multi-Protocol Label Switching (MPLS). The protocol is Transmission Control Protocol/Internet Protocol (TCP/IP). The interface to access to the system is terminal while the message format is Extensible Markup Language (XML).

1.6 Cash Settlement

On settlement day, participants must transfer the net cash obligations listed trades to their appropriate cash settlement accounts at BIDV after netting trades for proprietary, domestic clients, and foreign clients. Depository members have to transfer cash to their relevant accounts at BIDV (usually through the interbank system). BIDV will then process this through BIDV's system.

¹² Systems that settle transfer instructions for both securities and funds on a net basis, with final transfers of both securities and funds occurring at the end of the processing cycle.

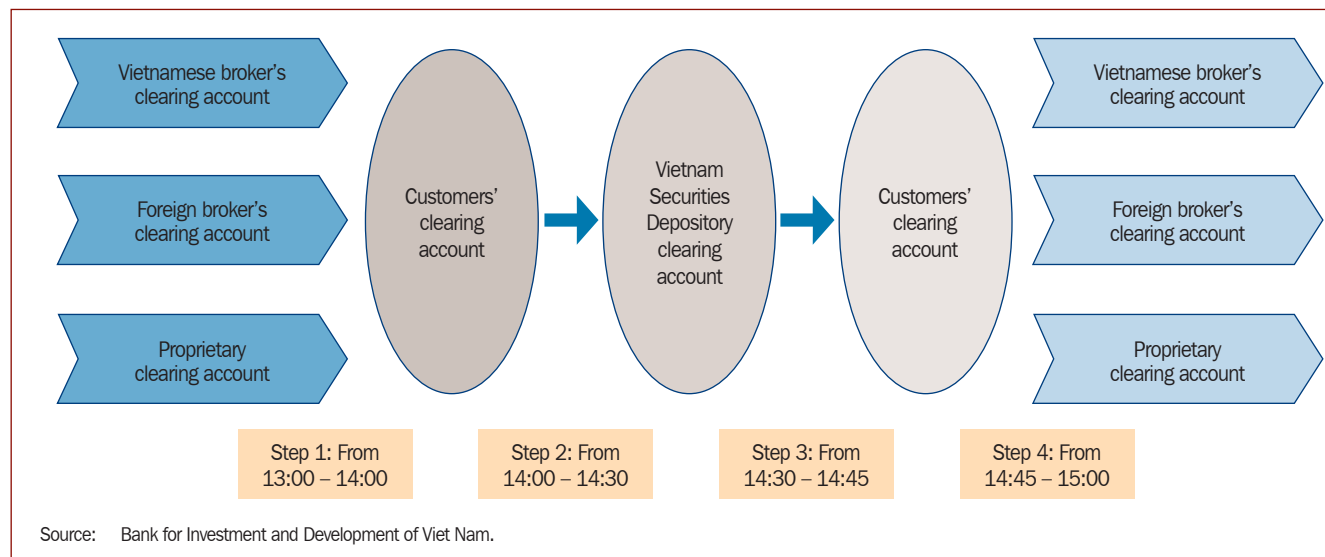
Figure 10.2 Cash Settlement Process in the Viet Nam Bond Market

2. Typical Business Flows

2.1 Delivery-versus-Payment Transaction Flow for Domestic Trade on the Over-the-Counter Market

Please refer to Part 3, Figures J.2 and J.3 for the bond transaction flow for domestic trades in the OTC market (DVP).

Traded data are entered to HNX and matched before it is transmitted to VSD.¹³ The trades are netted and settled through the accounts in the VSD for bonds and in the BIDV for cash. Therefore, it is not a real-time gross settlement. There are no messages transmitted neither from HNX nor VSD to participants (seller or buyer). Participants need to access from a web terminal or physically to the sites, and obtain information. Therefore, bond settlement infrastructures need to be reconstructed completely to meet ISO 20022. However, considering the current situation of the Viet Nam bond market and trades, it is an appropriate business flow with sufficient functions and robustness. The data are processed in a manner of straight through processing from VSD to BIDV.

2.2 Delivery-versus-Payment Transaction Flow for Cross-border Trade

Please refer to Part 3, Figure J.4 for the bond transaction flow for foreign investors in the OTC Market (DVP).

Cross-border trade transaction flow is in principle not very much different from the generally accepted flow in ASEAN+3 region. Foreign exchange funding to the domestic custodian of buyer needs to be completed before sending trade order. Pre-funding is also required.

¹³ Government and corporate bonds are nowadays traded only on HNX; however, some residual bonds (both municipal and corporate) remain on HOSE until maturity.

3. Matching

Matching at HNX is a proprietary matching. The seller and buyer enter traded data into HNX and forward the data to VSD after having been matched. Seller and buyer access the VSD system and check the stored data to be correct. Seller and buyer check the data and change the status of the data in VSD. If both seller and buyer confirm that the traded data are correct, it means bond settlement instructions are matched.

For government bonds traded on the OTC market, since seller or buyer does not send the bond settlement instruction to the VSD, confirmation of traded data stored in VSD to be correct by both seller and buyer is regarded as settlement instructions are matched.

4. Settlement Cycle

The settlement cycle for government bonds is based on the market practice generally accepted in ASEAN+3, which is T+2 or T+3, though it is regarded as T+1 based on local proprietary practice. In other words, the definition of trade date in Viet Nam is different from other ASEAN+3 markets. In Viet Nam, the date of traded data are entered to the HNX is the trade date instead of the date when the bond is actually traded and agreed upon by phone or some other measures. As such the standard settlement cycle in Viet Nam is T+2 or T+3.

5. Numbering and Coding

5.1 Numbering and Coding

5.1.1 Securities Numbering

VSD issues International Securities Identification Number (ISIN) for all bonds registered with VSD and listed in the stock exchanges since VSD is a full member of Association of National Numbering Agencies (ANNA). Local code is used domestically and needs to be converted to ISIN. The market allows investors the option of using ISIN codes and local codes. Local codes are used while ISIN codes are used alternatively subject to specific purposes.

5.1.2 Financial Institution Identification

Local code is used domestically. Conversion between local and Business Identifier Code (BIC) is necessary when foreign institutional investors use the BIC.

5.1.3 Securities Account

Local securities account is used.

5.1.4 Cash Account

Local cash account numbering is used.

5.1.5 Character Code and Language

Unicode (UTF-8) is used. Regarding language, Vietnamese is used as the official language for bond trade and settlement infrastructures.

6. Medium- to Long-Term Strategies

After entering traded data into HNX, the data are processed and transmitted to BIDV for cash settlement through VSD. As such it can be said that straight through processing (STP) is realized fitting the current situation in Viet Nam. However, there are still many paper-based processes between participants (seller and buyer) and infrastructure operators (HNX, VSD, and BIDV), which need to be improved. Therefore, it may be recommended that bond trade- and settlement-related infrastructure will be reconstructed based on international standards in the future.

New information technology-related initiatives to introduce STP (from trade to settlement, including depository) are currently being planned by the stock exchanges and the VSD. New investments to meet technical criteria set up by the stock exchanges and VSD need to be considered.

Part 3

Bond Market Infrastructure Diagrams,
Domestic Bond Transaction Flows, and
Cross-border Bond Transaction Flows

Contents

People's Republic of China (PRC)	1
Figure 1. PRC Bond Market Infrastructure Diagram	2
Figure 2. PRC Bond Transaction Flow for Domestic Trades OTC Market/DVP	3
Note: Description of PRC Bond Transaction Flow for Domestic Trades OTC Market/DVP.....	4
Figure 3. PRC Bond Transaction Flow for Domestic Trades Exchange Market/DVP	5
Note: Description of PRC Bond Transaction Flow for Domestic Trades Exchange Market/DVP.....	6
Figure 4. PRC Bond Transaction Flow for Foreign Investors OTC Market/RMB Banks	7
Note: Description of PRC Bond Transaction Flow for Foreign Investors OTC Market/RMB Banks.....	8
Figure 5. PRC Bond Transaction Flow for Foreign Investors Exchange Market/QFII	9
Note: Description of PRC Bond Transaction Flow for Foreign Investors Exchange Market/QFII.....	10
Hong Kong, China (HKG)	11
Figure 1. HKG Bond Market Infrastructure Diagram	12
Figure 2. HKG Bond Transaction Flow for Domestic Trades OTC Market/DVP	13
Note: Description of HKG Bond Transaction Flow for Domestic Trades OTC Market/DVP	14
Figure 3. HKG Bond Transaction Flow for Foreign Investors OTC Market/DVP	15
Note: Description of HKG Bond Transaction Flow for Foreign Investors OTC Market/DVP.....	16
Indonesia (INO)	17
Figure 1. INO Bond Market Infrastructure Diagram	18
Figure 2. INO Bond Transaction Flow for Domestic Trades OTC Market/DVP	19
Note: Description of INO Bond Transaction Flow for Domestic Trades OTC Market/DVP	20
Figure 3. INO Bond Transaction Flow for Foreign Trades OTC Market/DVP	21
Note: Description of INO Bond Transaction Flow for Foreign Trades OTC Market/DVP	22
Japan (JPN)	23
Figure 1. JPN Bond Market Infrastructure Diagram	24
Figure 2. JPN Bond Transaction Flow for Domestic Trades OTC Market (JGB)/DVP through Trade Matching (PSMS)	25
Note: Description of JPN Bond Transaction Flow for Domestic Trades OTC Market (JGB)/DVP through Trade Matching (PSMS)	26
Figure 3. JPN Bond Transaction Flow for Foreign Investors OTC Market (JGB)/DVP	27
Note: Description of JPN Bond Transaction Flow for Foreign Investors OTC Market (JGB)/DVP	28

Figure 4.	JPN Bond Transaction Flow for Domestic Trades OTC Market (JGB)/DVP (New BOJ-NET) through Trade Matching (PSMS)	29
Figure 5.	JPN Bond Transaction Flow OTC Market (JGB)/DVP (New BOJ-NET) through Trade Matching (PSMS) and JGBCC (1/2)	30
Figure 5.	JPN Bond Transaction Flow OTC Market (JGB)/DVP (New BOJ-NET) through Trade Matching (PSMS) and JGBCC (2/2)	31
Note:	Description of JPN Bond Transaction Flow OTC Market (JGB)/DVP (New BOJ-NET) through Trade Matching (PSMS) and JGBCC	32
Figure 6.	JPN Bond Transaction Flow OTC Market (Corporate Bonds)/DVP (BOJ-NET) through Trade Matching (PSMS)	33
Figure 7.	JPN Bond Transaction Flow OTC Market (JGB)/DVP other types of Trade Matching (PSMS) (1/2)	34
Figure 7.	JPN Bond Transaction Flow OTC Market (JGB)/DVP other types of Trade Matching (PSMS) (2/2)	35
Republic of Korea (KOR)		36
Figure 1.	KOR Bond Market Infrastructure Diagram	37
Figure 2.	KOR Bond Transaction Flow for Domestic Trades OTC Market/DVP	38
Note:	Description of KOR Bond Transaction Flow for Domestic Trades OTC Market/DVP	39
Figure 3.	KOR Bond Transaction Flow for Domestic Trades Exchange Market/DVP.....	40
Figure 4.	KOR Bond Transaction Flow for Foreign Investors OTC Market/DVP	41
Note:	Description of KOR Bond Transaction Flow for Foreign Investors OTC Market/DVP	42
Malaysia (MAL)		43
Figure 1.	MAL Bond Market Infrastructure Diagram	44
Figure 2.	MAL Bond Transaction Flow for Domestic Trades OTC Market/DVP	45
Note:	Description of MAL Bond Transaction Flow for Domestic Trades OTC Market/DVP	46
Figure 3.	MAL Bond Transaction Flow for Foreign Investors OTC Market/DVP	47
Note:	Description of MAL Bond Transaction Flow for Foreign Investors OTC Market/DVP	48
Philippines (PHI)		49
Figure 1.	PHI Bond Market Infrastructure Diagram.....	50
Figure 2.	PHI Bond Transaction Flow for Domestic Trades GSEDs Market/DVP	51
Note:	Description of PHI Bond Transaction Flow for Domestic Trades GSEDs* Market/DVP	52
Figure 3.	PHI Bond Transaction Flow for Domestic Trades Non-GSEDs Market/DVP	53
Note:	Description of PHI Bond Transaction Flow for Domestic Trades Non-GSEDs* Market/DVP	54
Figure 4.	PHI Bond Transaction Flow for Foreign Investors OTC Market/DVP	55
Note:	Description of PHI Bond Transaction Flow for Foreign Investors OTC Market/DVP	56
Singapore (SIN)		57
Figure 1.	SIN Bond Market Infrastructure Diagram.....	58
Figure 2.	SIN Bond Transaction Flow for Domestic Trades OTC Market/DVP.....	59
Note:	Description of SIN Bond Transaction Flow for Domestic Trades OTC Market/DVP	60
Figure 3.	SIN Bond Transaction Flow for Foreign Investors OTC Market/DVP.....	61
Note:	Description of SIN Bond Transaction Flow for Foreign Investors OTC Market/DVP	62

Thailand (THA)	63
Figure 1. THA Bond Market Infrastructure Diagram	64
Figure 2. THA Bond Transaction Flow for Domestic Trades OTC Market/DVP	65
Note: Description of THA Bond Transaction Flow for Domestic Trades OTC Market/DVP	66
Figure 3. THA Bond Transaction Flow for Foreign Investors OTC Market/DVP	67
Note: Description of THA Bond Transaction Flow for Foreign Investors OTC Market/DVP	68
Viet Nam (VIE)	69
Figure 1. VIE Bond Settlement Infrastructure Diagram	70
Figure 2. VIE Business Process Flow Government Bond Market/DVP	71
Note: Description of VIE Business Process Flow Government Bond Market/DVP (1/2)	72
Note: Description of VIE Business Process Flow Government Bond Market/DVP (2/2)	73
Figure 3. VIE Business Process Flow: Revised Bond Market/DVP	74
Figure 4. VIE OTC Bond Transaction Flow for Foreign Investors	75
Note: Description of VIE OTC Bond Transaction Flow for Foreign Investors	76
Bond Market Infrastructure Diagram	77
Figure 1. ASEAN+3 Government Bond Market Infrastructure Diagram	78

People's Republic of China (PRC)

Bond Market Infrastructures
and Bond Transaction Flow

Figure 1. PRC Bond Market Infrastructure Diagram

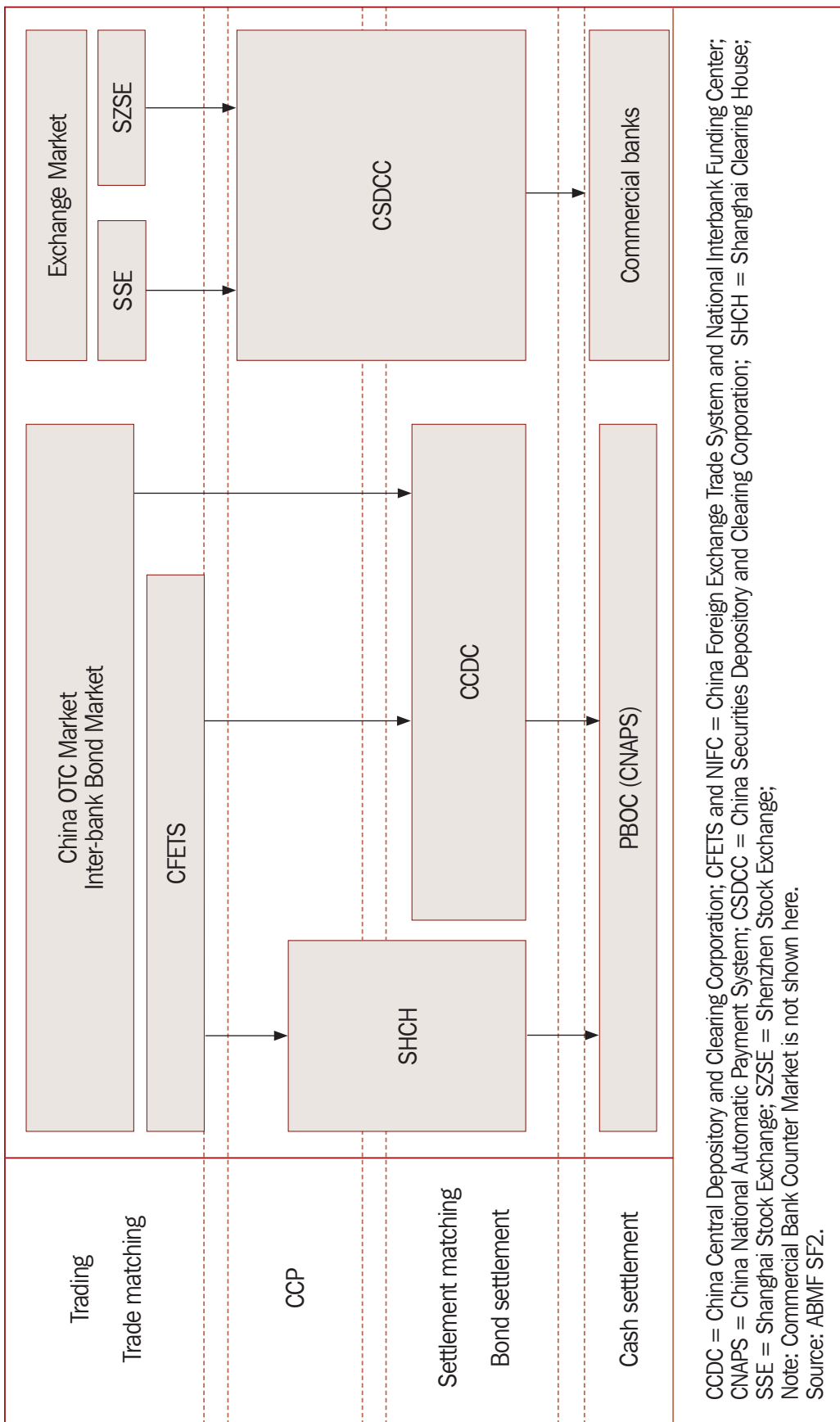
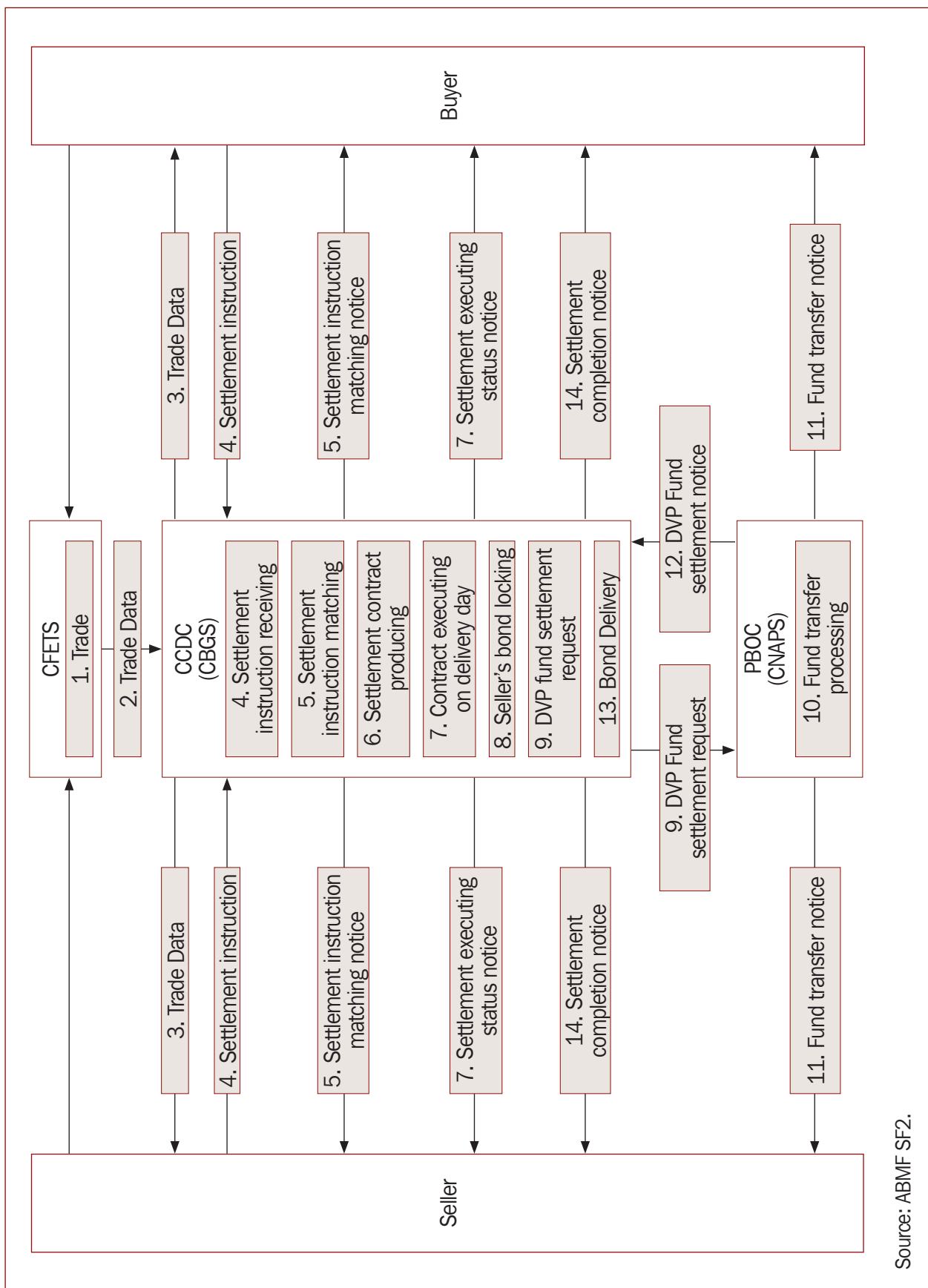

Figure 2. PRC Bond Transaction Flow for Domestic Trades OTC Market/DVP



Source: ABMF SF2.

Note: Description of PRC Bond Transaction Flow for Domestic Trades OTC Market/DVP

OTC Market

1. Seller and buyer trade bond via China Foreign Exchange Trade System (CFETS). CFETS provides several trading methods including bilateral negotiation and Click-and-Deal. In China OTC bond market, most of transactions are conducted through the electronic trading platform provided by CFETS, and a small part of the transactions are conducted through telephone or some other ways.
2. CFETS sends trade data to China Central Depository and Clearing (CCDC) or Shanghai Clearing House (SHCH).
3. About 5% of trade data are entered to CCDC directly from seller and buyer (refer to 4. Settlement instruction).
4. CCDC or SHCH sends trade data to seller and buyer for verification.
5. When seller and buyer received trade data from CCDC or SHCH, seller and buyer verify the data. If the data are correct, seller and buyer send affirmative message to CCDC. The messages are regarded as “settlement instructions” to CCDC or SHCH. About 5% of trades are directly entered to CCDC after traded in China OTC Market. In this case, one party (either seller or buyer) needs to send settlement instruction into CCDC system. The settlement instruction needs to contain full message items necessary for the settlement. CCDC system automatically asks the other party to confirm. If not, CCDC does not process settlement. After matching the order (local matching), CCDC settles the trade in FOP or DVP as requested by customers.
6. CCDC or SHCH matches settlement instructions from the seller and buyer and notifies matched result.
7. CCDC or SHCH produces settlement contract.
8. On the settlement day, CCDC or SHCH executes the settlement contract and notifies the status to the seller and buyer.
9. CCDC or SHCH blocks seller's bond to secure DVP transaction.
10. CCDC or SHCH sends DVP fund settlement request to People's Bank of China (PBOC).
11. PBOC executes fund settlement. Fund is transferred from buyer's current account to seller's current account by High Value Payment System (HVPS) of CNAPS.
12. PBOC sends fund transfer notice to the seller and buyer.
13. PBOC sends DVP fund settlement notice to CCDC or SHCH.
14. CCDC or SHCH executes bond delivery (release blocked bond).
15. CCDC or SHCH sends settlement completion notice to the seller and buyer.

Source: ABMF SF2.

Figure 3. PRC Bond Transaction Flow for Domestic Trades Exchange Market/DVP

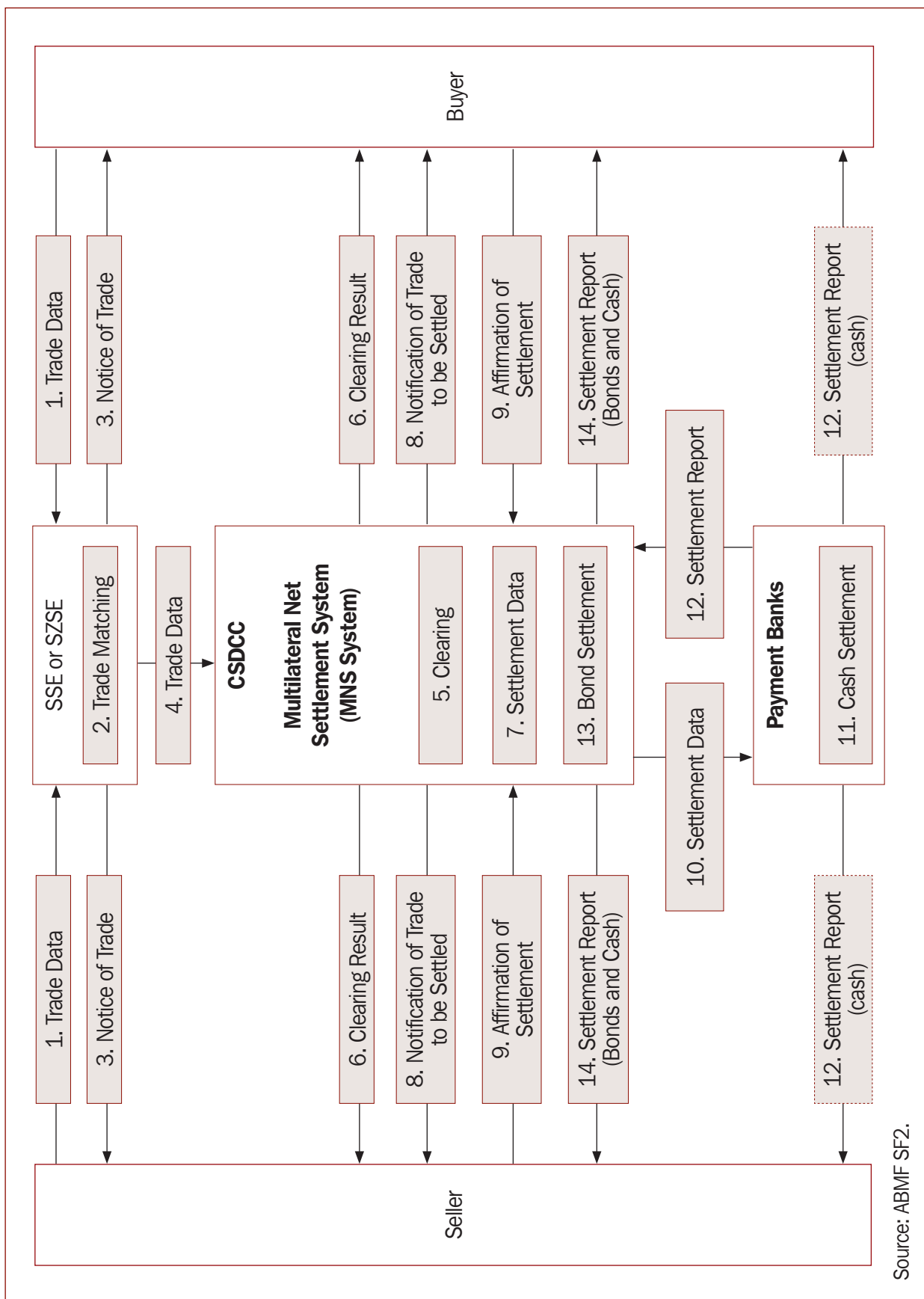

Note: Description of PRC Bond Transaction Flow for Domestic Trades Exchange Market/DVP

Exchange Market

1. The seller and buyer trade via Shanghai Stock Exchange (SSE) or Shenzhen Stock Exchange (SZSE).
2. SSE/SZSE collates orders from the seller and buyer.
3. SSE/SZSE sends notice of trade to the seller and buyer.
4. SSE/SZSE sends trade data to China Central Depository and Clearing Corporation (CSDCC).
5. Clearing function in CSDCC executes clearing process.
6. Clearing function in CSDCC sends clearing result to the seller and buyer.
7. Clearing function in CSDCC sends settlement data to CSD function in CSDCC.
8. CSD function in CSDCC sends notice of trade to be settled to the seller and buyer.
9. The seller and buyer send affirmation of settlement.
10. CSDCC sends settlement data to payment banks.
11. Payment banks perform cash settlement.
12. Payment banks sends settlement reports to CSDCC, seller and buyer.
13. CSD function in CSDCC executes bond settlement.
14. CSDCC sends settlement report (bonds and cash) to the seller and buyer.

Source: ABMF SF2.

Figure 4. PRC Bond Transaction Flow for Foreign Investors OTC Market/RMB Banks

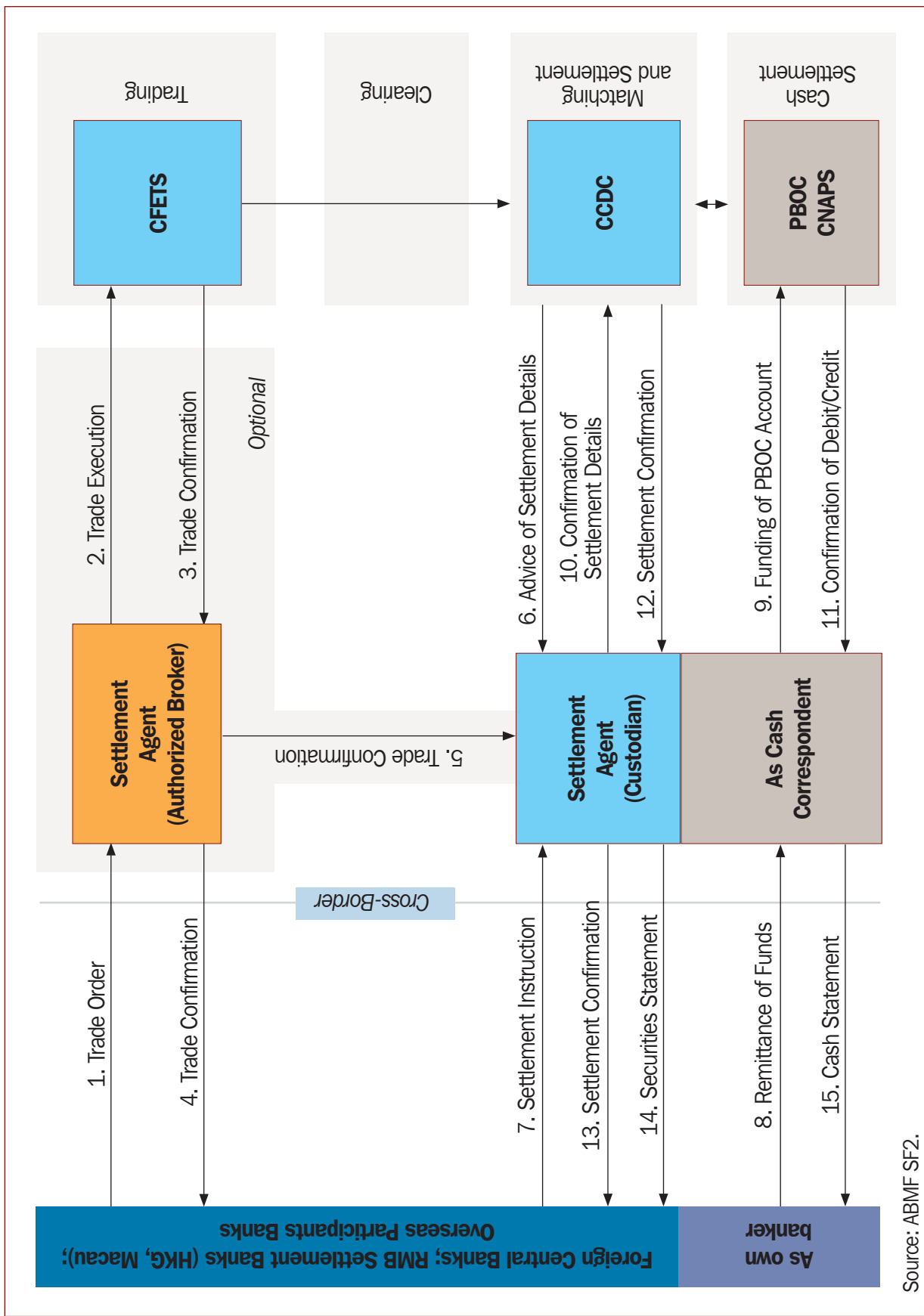

Source: ABMF SF2.

Note: Description of PRC Bond Transaction Flow for Foreign Investors OTC Market/RMB Banks

Trade Date

1. Eligible Institution/RMB Bank places order with Settlement Agent (Authorized Broker).
2. Settlement Agent, executes trade on CFETS, then captures trade details in CFETS.
3. Settlement Agent receives trade confirmation from/Via CFETS.
4. Settlement Agent sends trade confirmation to Eligible Institution/RMB Bank.
5. Settlement Agent sends trade confirmation to Settlement Agent (custodian).
6. CCDC sends advice of settlement details sent directly from CFETS to Settlement Agent.

Settlement Date (T + 1)

7. Eligible Institution/RMB Bank instructs Settlement Agent on settlement details.
8. Eligible Institution/RMB Bank remits RMB amount to Settlement Agent (custodian).
9. Settlement Agent funds own PBOC account, in preparation for settlement.
10. Settlement Agent confirms/affirms settlement details via CCDC (front-end) system.
11. Upon confirmations from both Settlement Agents, cash settlement is triggered by CCDC and PBOC will send a confirmation of debit or credit to the Settlement Agent.
12. Upon confirmations from both Settlement Agents, securities settlement is effected and CCDC will send a securities settlement confirmation to the Settlement Agent.
13. Settlement Agent sends settlement confirmation to Eligible Institution/RMB Bank.
14. At end of day, Settlement Agent sends securities statement to Eligible Institution/RMB Bank.
15. At end of day, Settlement Agent sends cash movement confirmation/cash statement to Eligible Institution/RMB Bank.

Source: ABMF SF2.

Figure 5. PRC Bond Transaction Flow for Foreign Investors Exchange Market/QFII

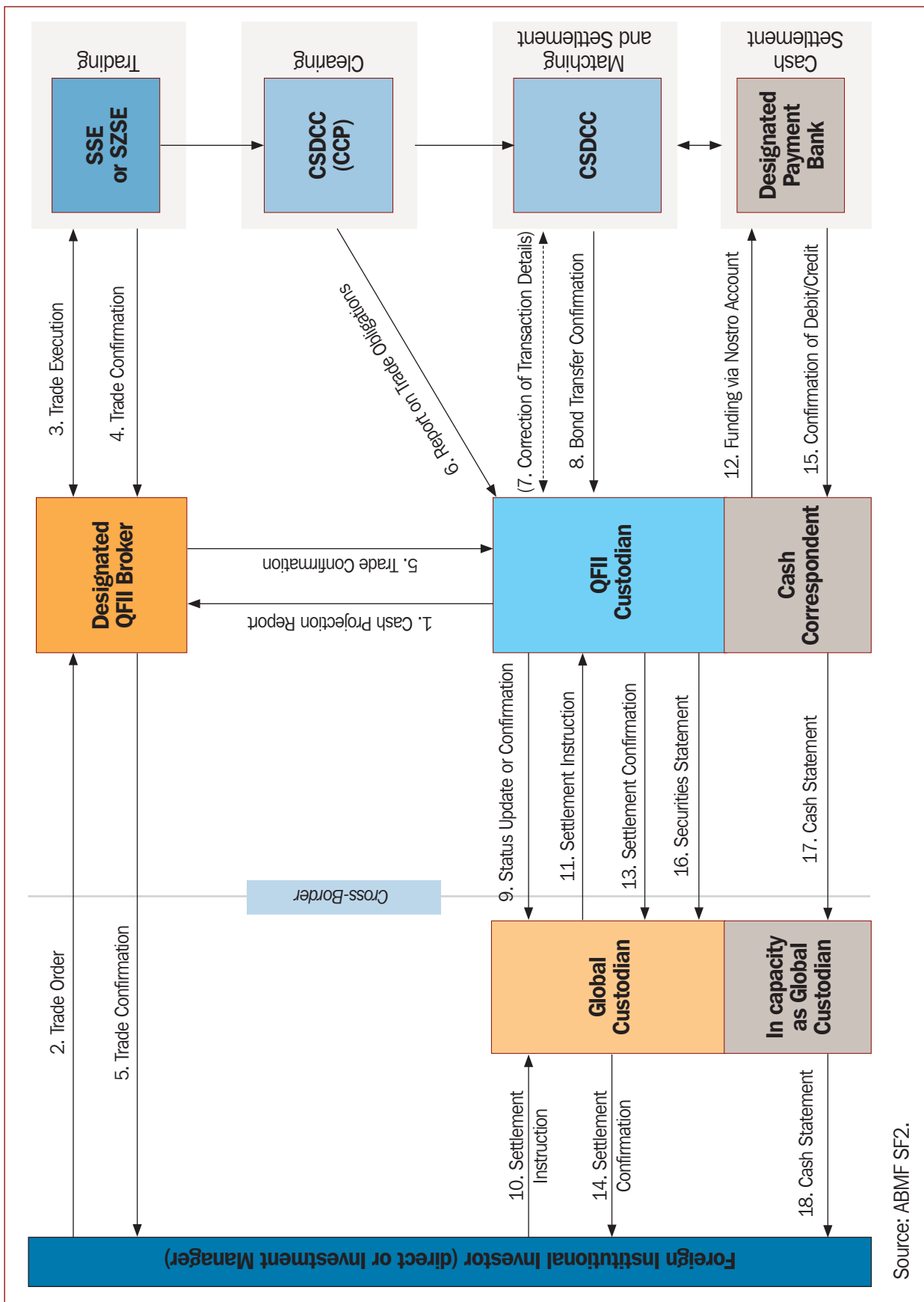

Source: ABMF SF2.

Note: Description of PRC Bond Transaction Flow for Foreign Investors Exchange Market/QFII

Trade Date

1. QFII Custodian sends cash projection report to Designated QFII Broker.
2. QFII places order with Designated QFII Broker.
3. Designated QFII Broker checks balance, executes trade on Shanghai Stock Exchange (SSE), or Shenzhen Stock Exchange (SZSE).
4. Designated QFII Broker receives trade confirmation.
5. Designated QFII Broker sends trade confirmation to QFII, and to QFII Custodian.
6. QFII Custodian downloads Report on Trade Obligations from CSDCC (Clearing function).
7. Only in the event of a discrepancy, QFII Custodian needs to contact CSDCC.
8. CSDCC (Settlement function) sends confirmation of transfer of bonds to QFII Custodian (on T evening).
9. QFII Custodian sends status update or partial settlement confirmation to Global Custodian.

Settlement Date

10. QFII instructs Global Custodian on settlement details.
11. Global Custodian instructs QFII Custodian on settlement details.
12. QFII Custodian funds settlement clearing reserve account (CSDCC account at Payment Bank).
13. After cash settlement deadline (in effect completion of trade settlement), QFII Custodian sends settlement confirmation to Global Custodian.
14. Global Custodian sends settlement confirmation to QFII.
15. Payment Bank sends debit/credit information in form of cash statement to QFII Custodian.
16. QFII Custodian sends securities statement to Global Custodian (end of day).
17. QFII Custodian sends cash movement confirmation/cash statement to Global Custodian (end of day).
18. Global Custodian sends cash movement confirmation/cash statement to QFII (end of day).

Source: ABMF SF2.

Hong Kong, China (HKG)

Bond Market Infrastructures
and Bond Transaction Flow

Figure 1. HKG Bond Market Infrastructure Diagram

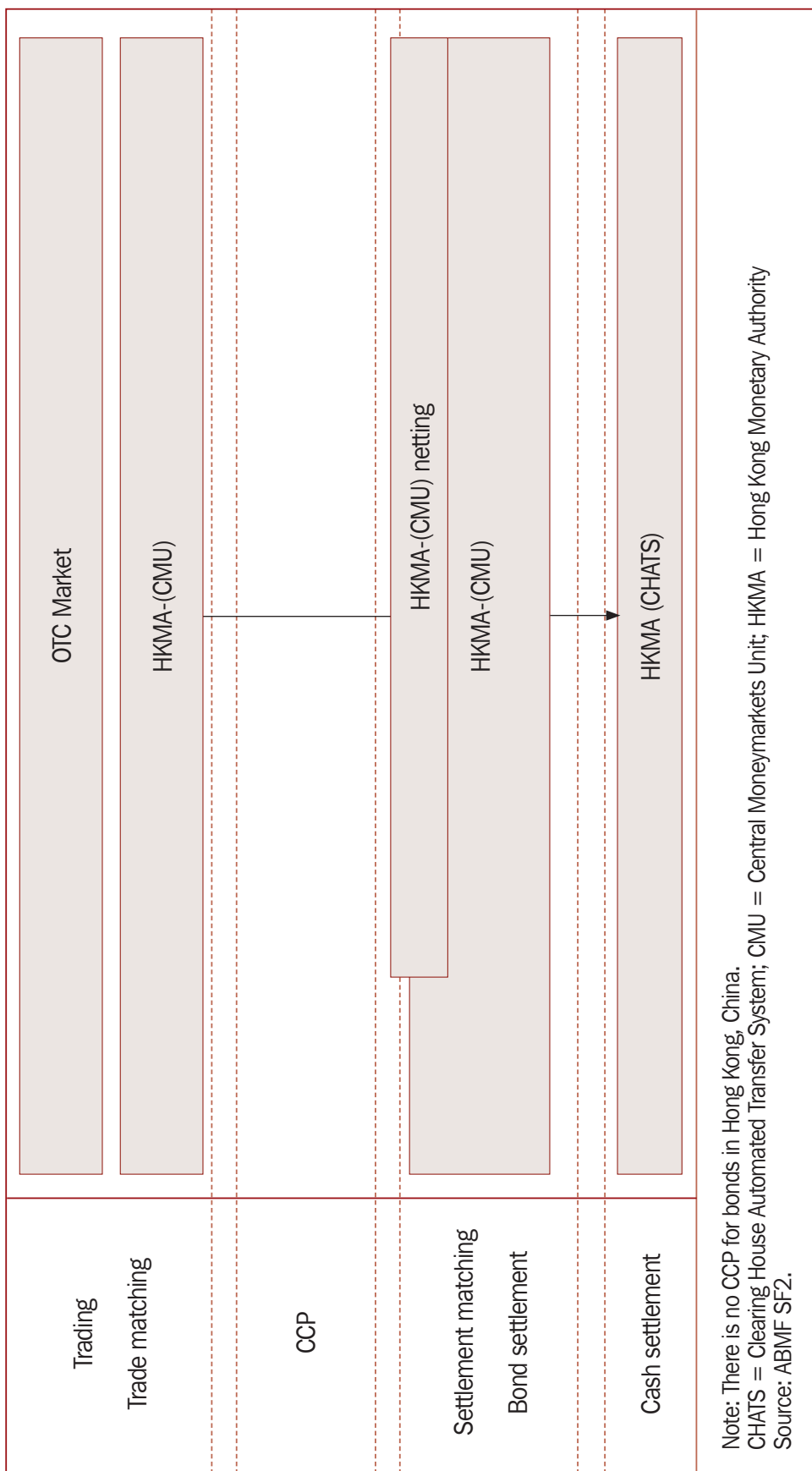
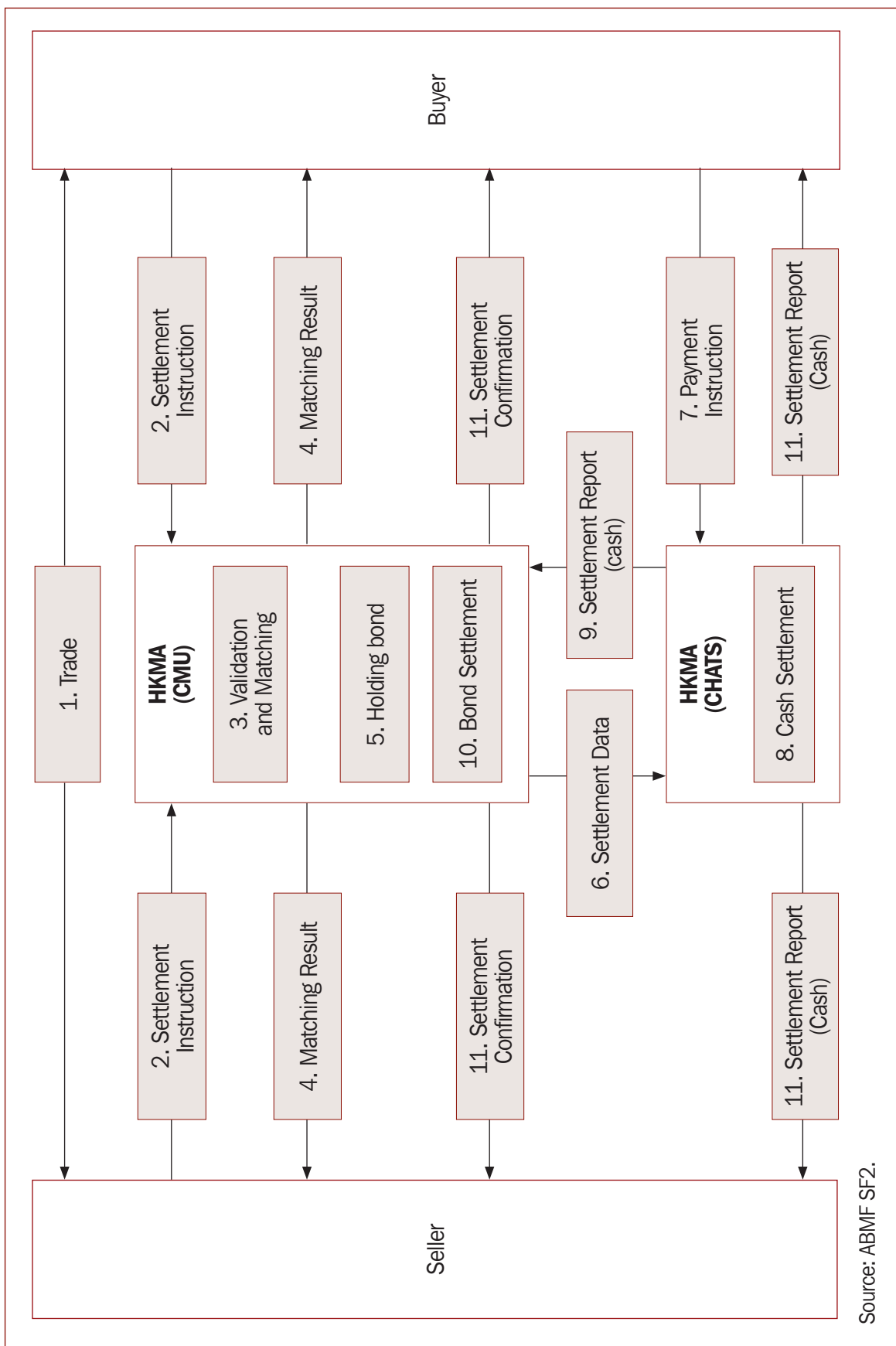

Figure 2. HKG Bond Transaction Flow for Domestic Trades OTC Market/DVP



Note: Description of HKG Bond Transaction Flow for Domestic Trades OTC Market/DVP**OTC Market**

1. Seller and buyer trade over the counter.
2. The seller and buyer send instructions to Central Moneymarkets Unit (CMU) via CMT, SWIFT, Fax, AFT or by hand. When they use system, either seller or buyer enters trade data to be forwarded to the counterpart (buyer or seller). The counterpart can utilize the trade information as a message instruction to be sent to the CMU. Participants need to send the message instructions before the cutoff time (4:00 p.m.) on settlement day.
3. CMU performs validation and matching.
4. CMU sends matching result to the seller and buyer.
5. CMU holds the bond.
6. CMU sends settlement data to CHATS.
7. For real time DVP settlement involving non-bank debt securities buyer, the buyer instructs its bank to pay by sending payment instruction to CHATS.
8. CHATS executes cash settlement.
9. CHATS sends cash settlement report to CMU.
10. CMU executes bond settlement.
11. CHATS sends cash settlement report to the buyer and seller respectively, while CMU sends securities settlement confirmation to the seller and buyer.

Source: ABMF SF2.

Figure 3. HKG Bond Transaction Flow for Foreign Investors OTC Market/DVP

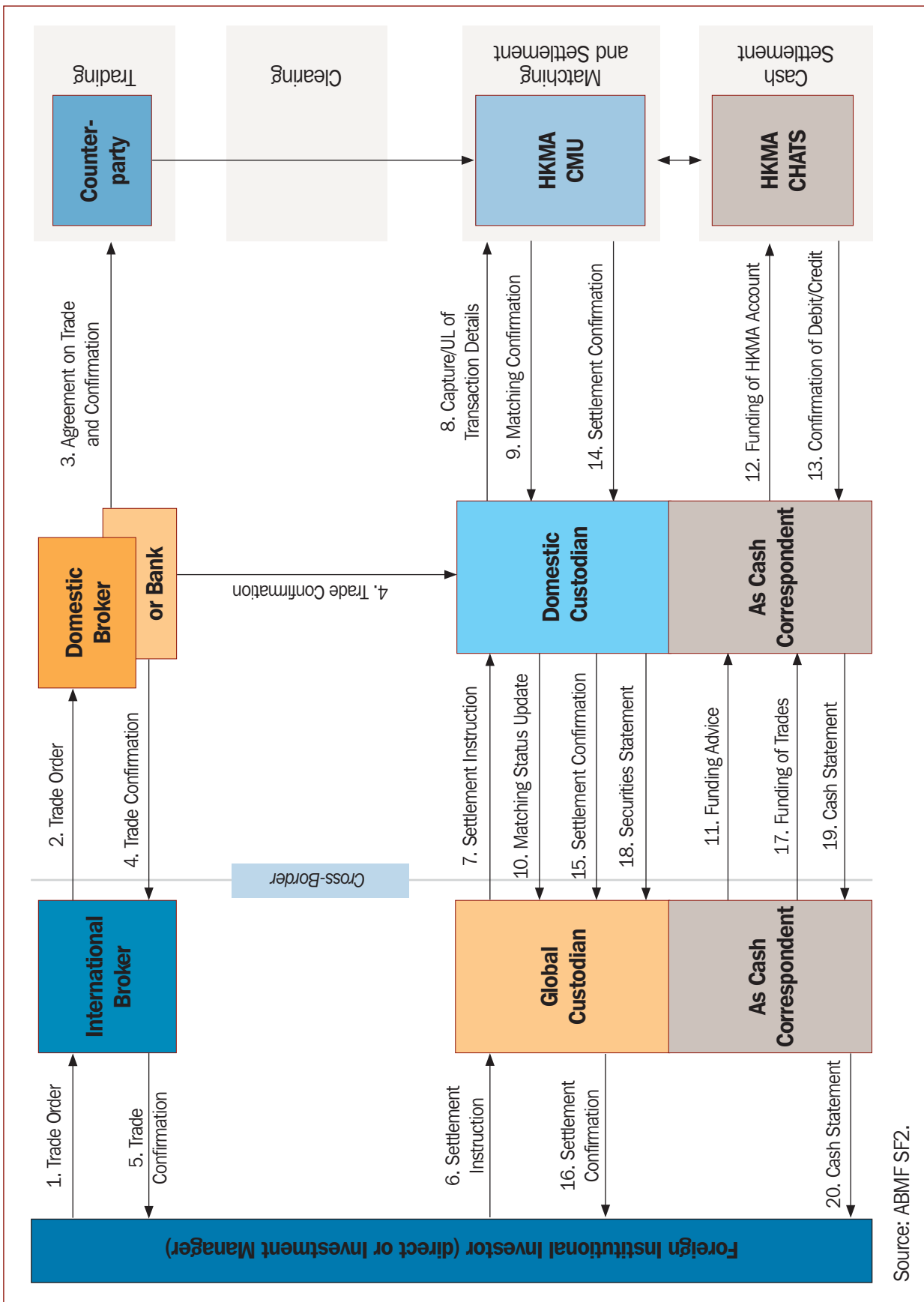

Note: Description of HKG Bond Transaction Flow for Foreign Investors OTC Market/DVP

Trade Date

1. Foreign Institutional Investor places order with International Broker.
2. International Broker places order with Domestic Broker/Bank.
3. Domestic Broker/Bank trades OTC with Counterparty (via phone or, e.g., Bloomberg).
4. Domestic Broker/Bank sends trade confirmation to International Broker.
5. Foreign Institutional Investor receives trade confirmation.
6. Foreign Institutional Investor instructs Global Custodian, on securities settlement and cash funding details.

T + 1

7. Global Custodian instructs Domestic Custodian on securities settlement.

Settlement Date

8. Domestic Custodian captures (eCMT or upload) settlement instructions into CMU.
9. Domestic Custodian receives transaction matching confirmation from CMU, or status updates.
10. Domestic Custodian sends matching status update to Global Custodian, either as report or, typically, per individual transaction.
11. Global Custodian advises funding details to Domestic Custodian.
12. Domestic Custodian effects funding of HKMA account via CHATS.
13. Upon transfer of cash, HKMA sends cash settlement confirmation to Domestic Custodian.
14. Upon transfer of bonds, CMU sends bond settlement confirmation to Domestic Custodian.
15. Domestic Custodian sends settlement confirmation to Global Custodian.
16. Foreign Institutional Investor receives settlement confirmation from Global Custodian.
17. Global Custodian funds trades into Domestic Custodian HKD account, or into FCY nostro.
18. Domestic Custodian sends securities statement to Global Custodian (end of day).
19. Domestic Custodian sends debit/credit confirmation as cash statement to Global Custodian (end of day).
20. Global Custodian sends debit/credit confirmation in cash statement to Foreign Institutional Investor (end of day).

Source: ABMF SF2.

Indonesia (INO)

Bond Market Infrastructures
and Bond Transaction Flow

Figure 1. INO Bond Market Infrastructure Diagram

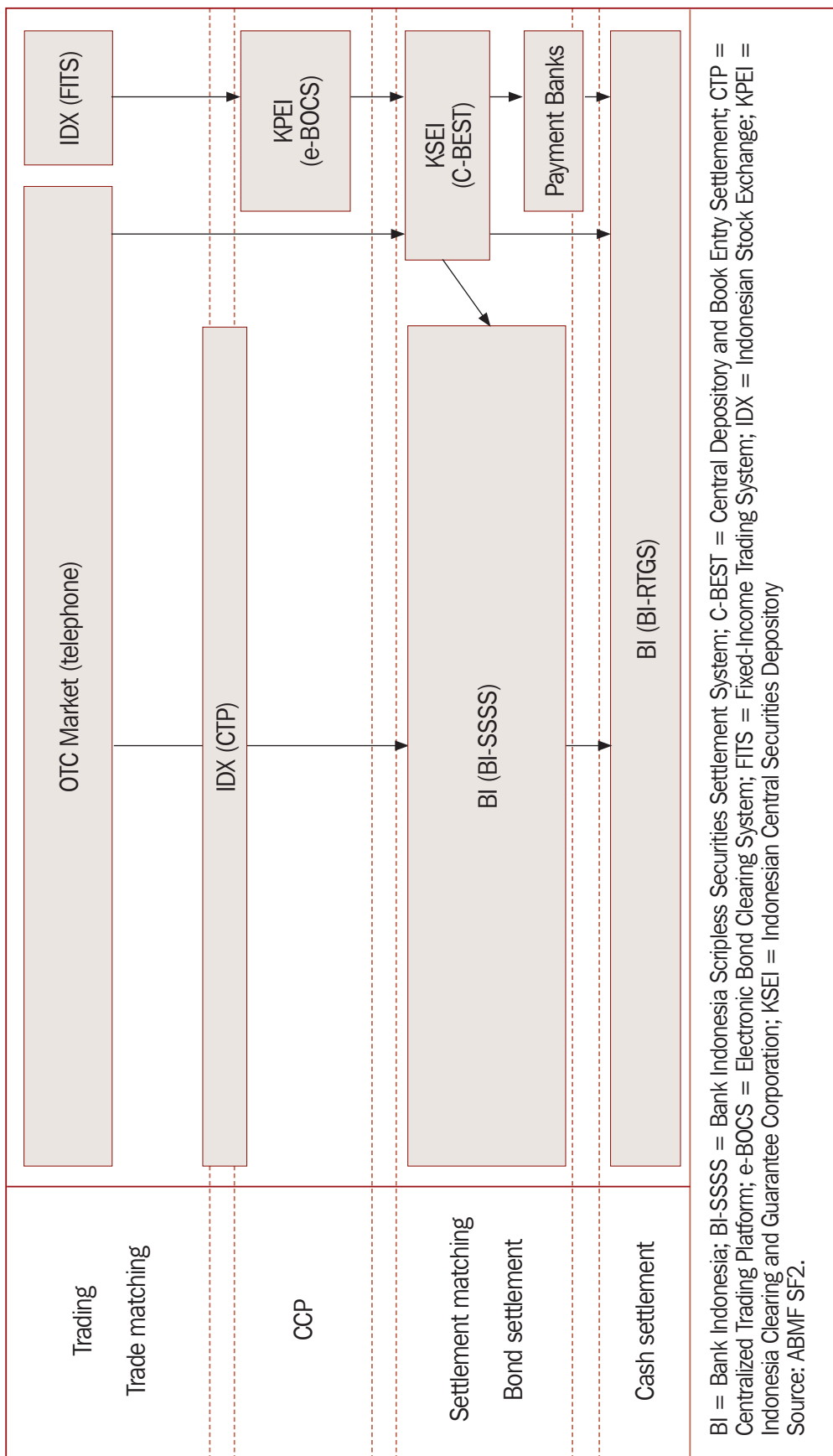
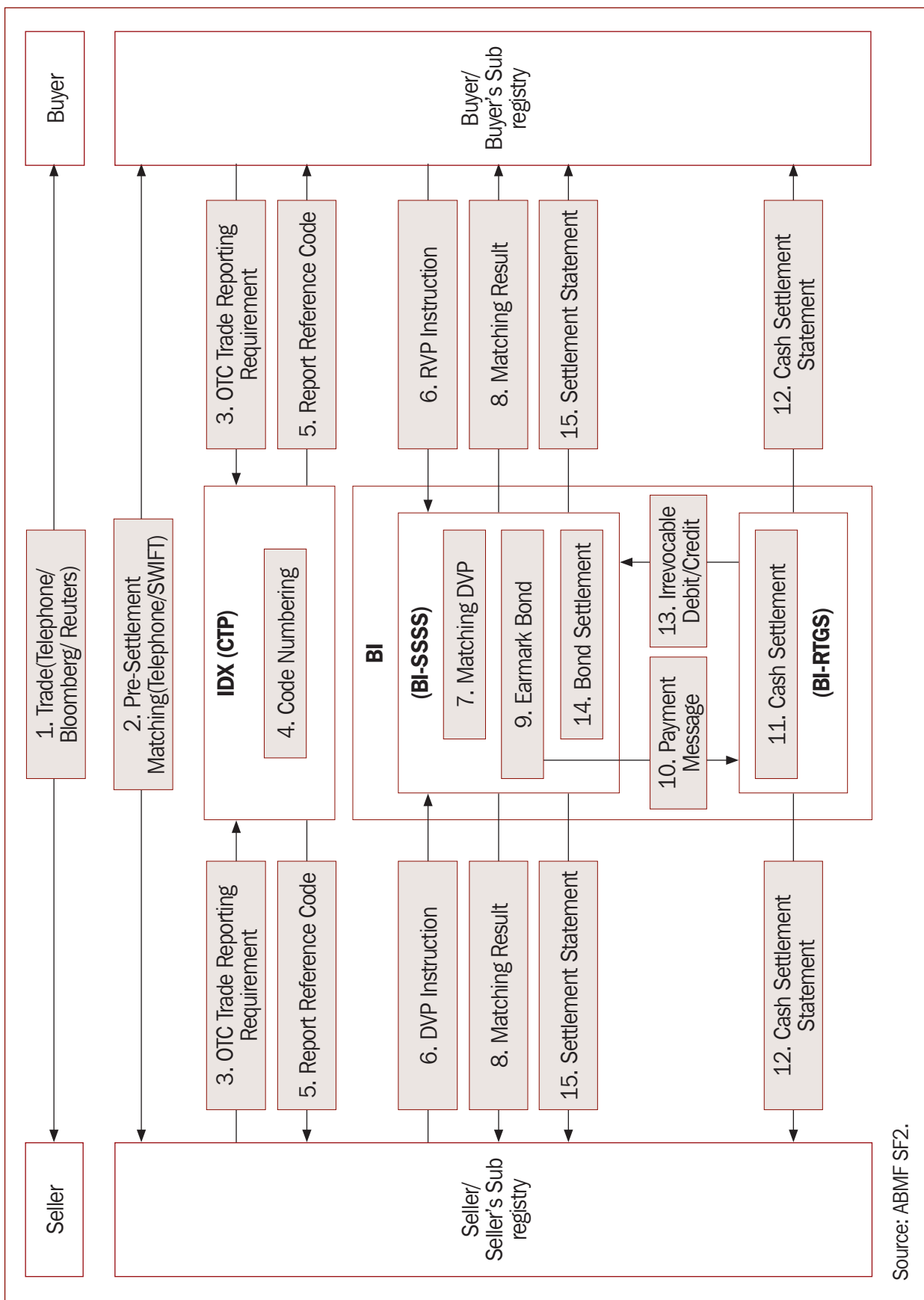

Figure 2. INO Bond Transaction Flow for Domestic Trades OTC Market/DVP



Source: ABMF SF2.

Note: Description of INO Bond Transaction Flow for Domestic Trades OTC Market/DVP

OTC Market

1. The seller and buyer trade government bonds over-the-counter. Most of trades are done by telephones.
2. Both seller and buyer send pre-settlement matching instructions over the SWIFT or pre-match the traded data for settlement over the telephone. Before the pre-settlement matching two components of bond taxes which are capital gains tax (CGT) and interest (withholding) tax need to be calculated. Pre-settlement matching is performed via telephone or swift.
3. The seller or buyer have to report trade data to Centralized Trading Platform (CTP) of Indonesia Stock Exchange (IDX) within 30 minutes of trade.
4. IDX puts the code on each trade.
5. The seller and buyer receive report reference code from IDX.
6. The seller and buyer key in the DVP and RVP instructions to BI-SSSS, respectively.
7. BI-SSSS performs the matching.
8. BI-SSSS reports the matching results to the seller and buyer.
9. Bond is earmarked to secure the DVP.
10. Payment message for DVP is sent to Bank Indonesia Real Time Gross Settlement (BI-RTGS)
11. When the funds are available, the amount is debited from the buyer's cash account and credited to the seller's cash account.
12. BI-RTGS sends the cash settlement statements to the seller and buyer.
13. BI-RTGS notifies the irrevocable debit/credit status to BI-SSSS.
14. BI-SSSS completes bond settlement.
15. BI-SSSS reports the settlement status to both seller and buyer.

Source: ABMF SF2.

Figure 3. INO Bond Transaction Flow for Foreign Trades OTC Market/DVP

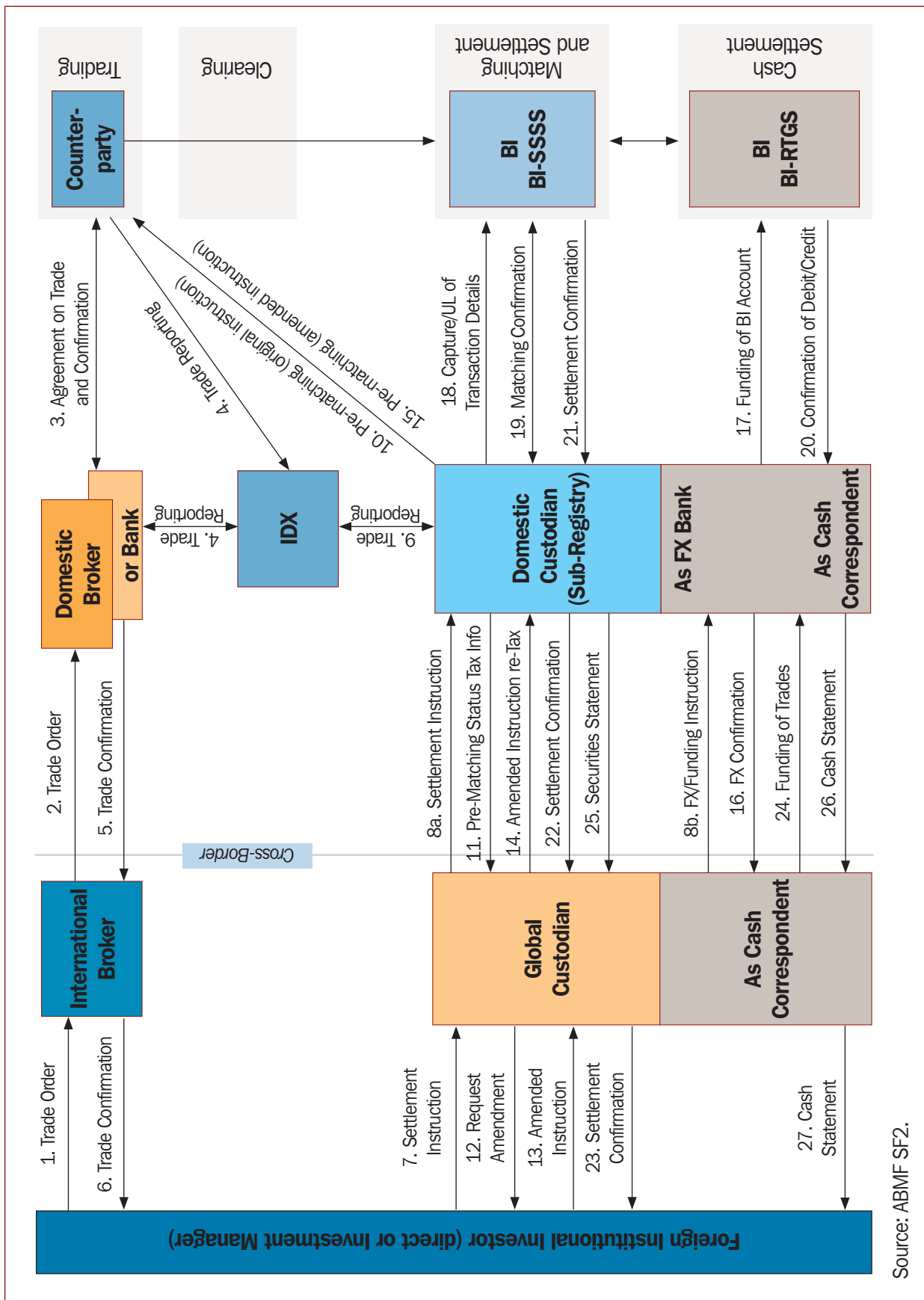

Note: Description of INO Bond Transaction Flow for Foreign Trades OTC Market/DVP

Trade Date

1. Foreign Institutional Investor places order with International Broker.
 2. International Broker/Domestic Investor places order with Domestic Broker/Bank.
 3. Domestic Broker/Bank and Counterparty agree on OTC trade (via e.g. phone or Bloomberg).
 4. Domestic Broker/Bank and Counterparty report trade to IDX for price discovery (within 30 minutes of trade).
 5. Domestic Broker/Bank sends trade confirmation to International Broker.
 6. Foreign Institutional Investor receives trade confirmation.
- T + 1**
7. Foreign Institutional Investor instructs Global Custodian, on securities settlement and cash/funding details.
 8. Global Custodian instructs Domestic Custodian/Sub-Registry on (a) securities settlement details, (b) FX request or funding details.
 9. Domestic Custodian/Sub-Registry reports trade details to IDX (within 30 minutes of receipt of instruction), and obtains CTP number.
 10. Domestic Custodian/Sub-Registry pre-matches with Counterparty (via phone or email), capital gains tax (CGT) calculated and agreed.
 11. Domestic Custodian/Sub-Registry advises Global Custodian on required amendment of settlement amount for CGT.
 12. Global Custodian requests Foreign Institutional Investor to amend settlement amount for CGT.

Settlement Date

13. Foreign Institutional Investor sends amended settlement instruction to Global Custodian.
14. Global Custodian sends amended settlement instruction to Domestic Custodian/Sub-Registry.
15. Domestic Custodian/Sub-Registry and Counterparty pre-match again on amended settlement amount (via phone or email).
16. Domestic Custodian/Sub-Registry confirms actual FX amount to Global Custodian.
17. Domestic Custodian/Sub-Registry funds its account at BI via RTGS.
18. Domestic Custodian/Sub-Registry enters or uploads trade details into BI-SSSS system.
19. Domestic Custodian/Sub-Registry retrieves BI-SSSS matching status.
20. Upon settling cash, BI-RTGS sends debit/credit confirmation to Domestic Custodian/Sub-Registry.
21. Upon settling securities, BI-SSSS sends settlement confirmation for securities to Domestic Custodian/Sub-Registry.
22. Domestic Custodian/Sub-Registry sends settlement confirmation to Global Custodian.
23. Global Custodian sends settlement confirmation to Foreign Institutional Investor.
24. Global Custodian funds account with Domestic Custodian/Sub-Registry.
25. Domestic Custodian/Sub-Registry sends statement of securities to Global Custodian (at end of day).
26. Domestic Custodian/Sub-Registry sends debit/credit information in cash statement (at end of day).
27. Global Custodian sends debit/credit information in cash statement (at end of day) to Foreign Institutional Investor.

Source: ABMF SF2.

Japan (JPN)

Bond Market Infrastructures
and Bond Transaction Flow

Figure 1. JPN Bond Market Infrastructure Diagram

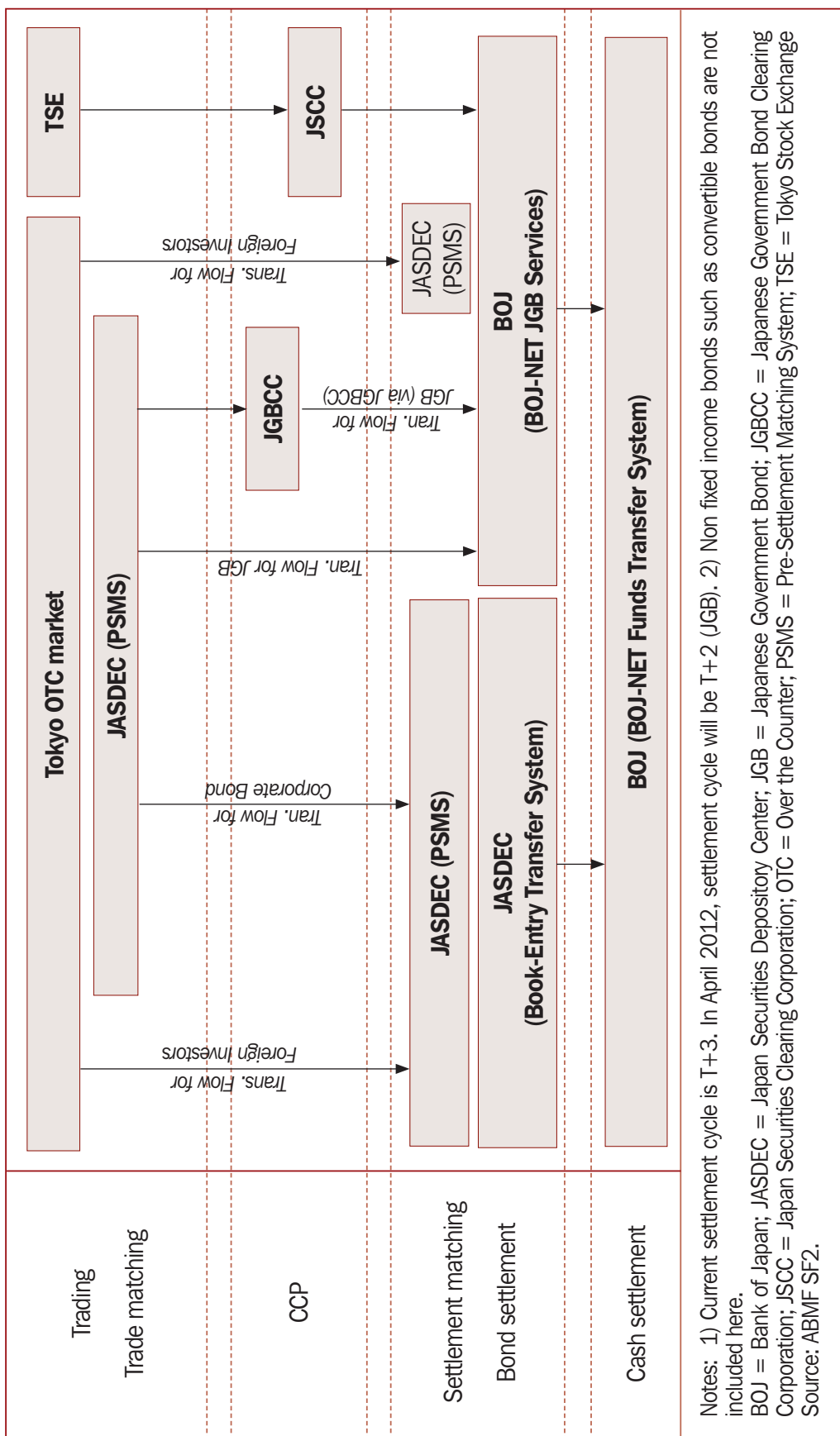
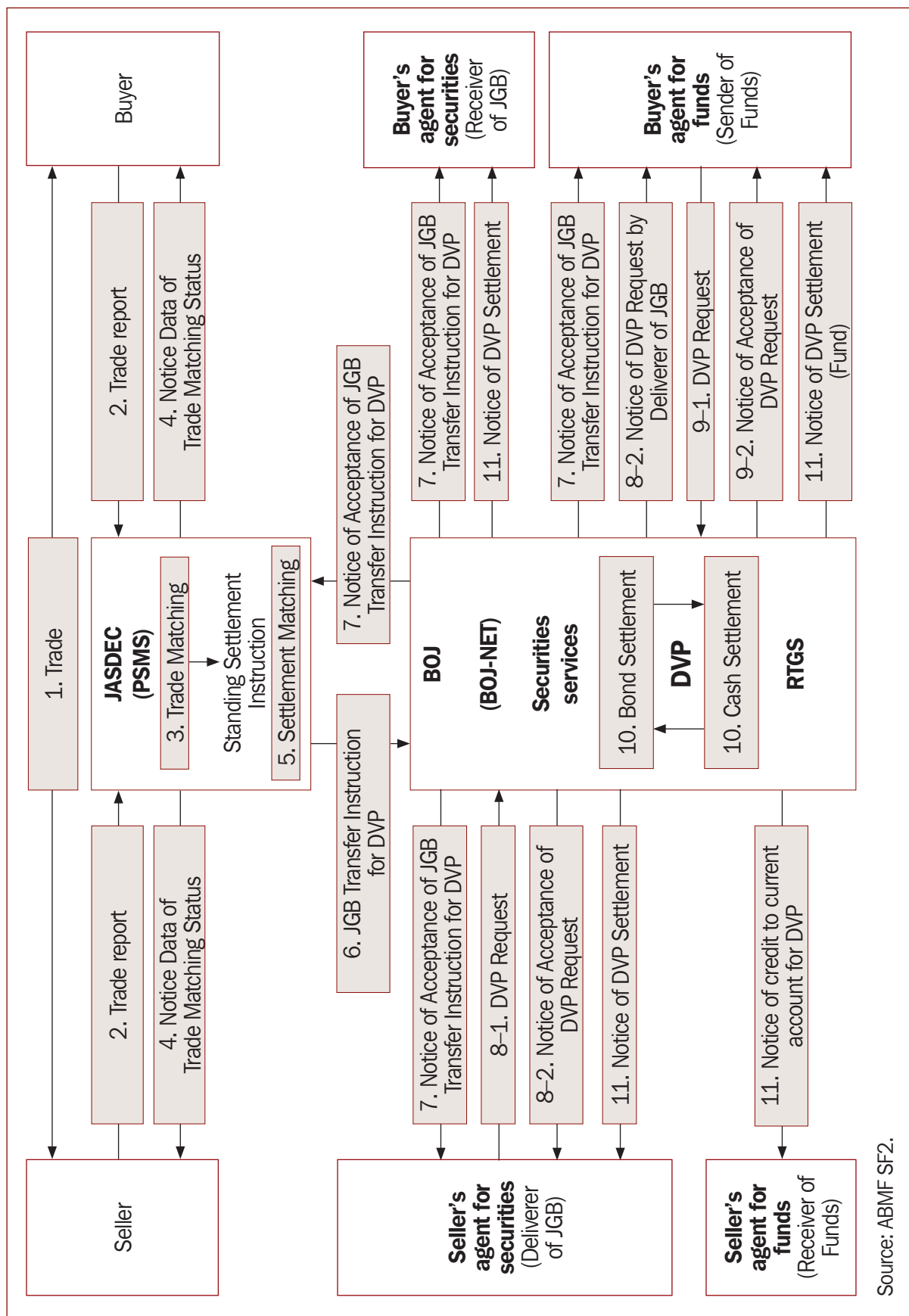

Figure 2. JPN Bond Transaction Flow for Domestic Trades OTC Market (JGB)/DVP through Trade Matching (PSMS)



Source: ABMIF SF2.

Note: Description of JPN Bond Transaction Flow for Domestic Trades OTC Market (JGB)/DVP through Trade Matching (PSMS)

1. The seller and buyer trade government bond over-the-counter.
2. Both seller and buyer send Trade Report data into PSMS (Pre-Settlement Matching System).
3. PSMS performs matching.
4. PSMS sends the Notice Data of Trade Matching Status to both sides of trade.
5. The buyer or the seller sends DVP instruction to BOJ-NET.
6. BOJ-NET sends the Notice of Acceptance of JGB Transfer Instruction for DVP to the seller (or the buyer).
- 7-1. The seller enters DVP Request to BOJ-NET.
- 7-2. The buyer enters DVP Request to BOJ-NET (for cash).
- 8-1. BOJ-NET sends the Notice of Acceptance of DVP Request to seller and completes settlement.
- 8-2. BOJ-NET sends the Notice of Acceptance of DVP Request to buyer and completes settlement (for cash).
9. BOJ-NET performs security and cash settlement.
10. When DVP settlement completed, BOJ-NET sends the Notice of credit to current account for DVP to the seller and buyer.

Source: ABMF SF2.

Note: Description of JPN Bond Transaction Flow for Foreign Investors OTC Market (JGB)/DVP

T+2 – Trade Date

1. Foreign Institutional Investor places order with International Broker.
2. International Broker places order with Domestic Broker/Bank.
3. Domestic Broker/Bank trades OTC with Counterparty (via phone or e.g. Bloomberg).
4. Domestic Broker/Bank send trade confirmation to International Broker.
5. Foreign Institutional Investor receives trade confirmation.
6. Foreign Institutional Investor instructs Global Custodian on securities settlement details.
7. Global Custodian instructs Domestic Custodian on securities settlement details.
8. Domestic Broker and domestic Custodian input trade details into PSMS.
9. PSMS responds with matching status.
10. Domestic Custodian reports transaction status update to Global Custodian.

Settlement Date

11. Domestic Custodian/Direct Participant sends JGB transfer instruction for DVP and receives Notification of Acceptance.
12. Domestic Custodian/Direct Participant send DVP request to BOJ-NET.
13. Domestic Custodian/Direct Participant as receives confirmation of DVP settlement.
14. Domestic Custodian sends settlement confirmation to Global Custodian.
15. Global Custodian funds account with Domestic Custodian, or into FCY nostro (before end of day).
16. Global Custodian sends settlement confirmation to Foreign Institutional Investor.
17. Domestic Custodian sends securities statement to Global Custodian.
18. Domestic Custodian sends cash credit/debit confirmation in cash statement to Global Custodian.
19. Global Custodian sends credit/debit confirmation in cash statement to Foreign Institutional Investor.

Source: ABMF SF2.

Figure 4. JPN Bond Transaction Flow for Domestic Trades OTC Market (JGB)/DVP (New BOJ-NET) through Trade Matching (PSMS)

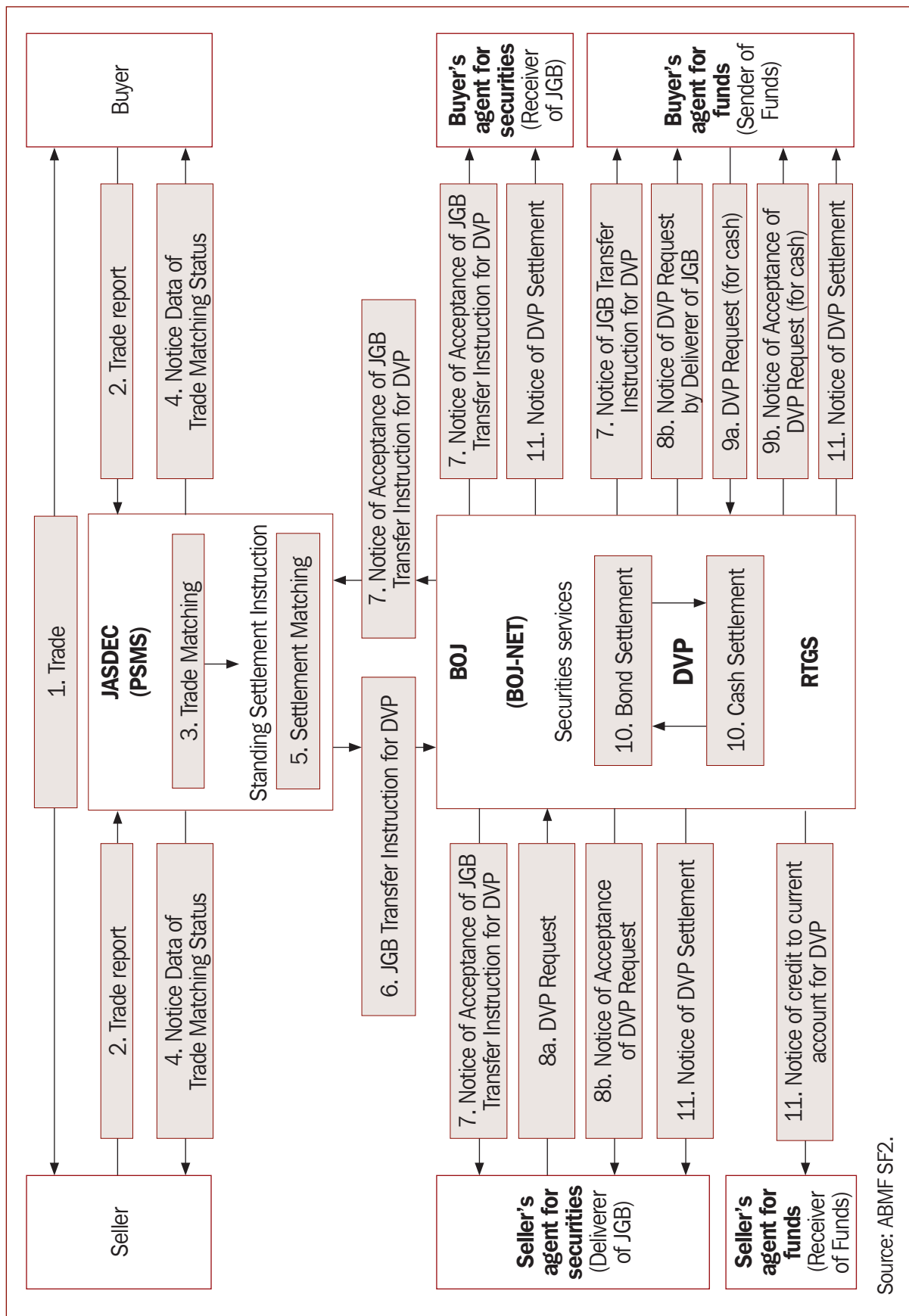

Source: ABMF SF2.

Figure 5. JPN Bond Transaction Flow OTC Market (JGB)/DVP (New BOJ-NET) through Trade Matching (PSMS) and JGBCC (1/2)

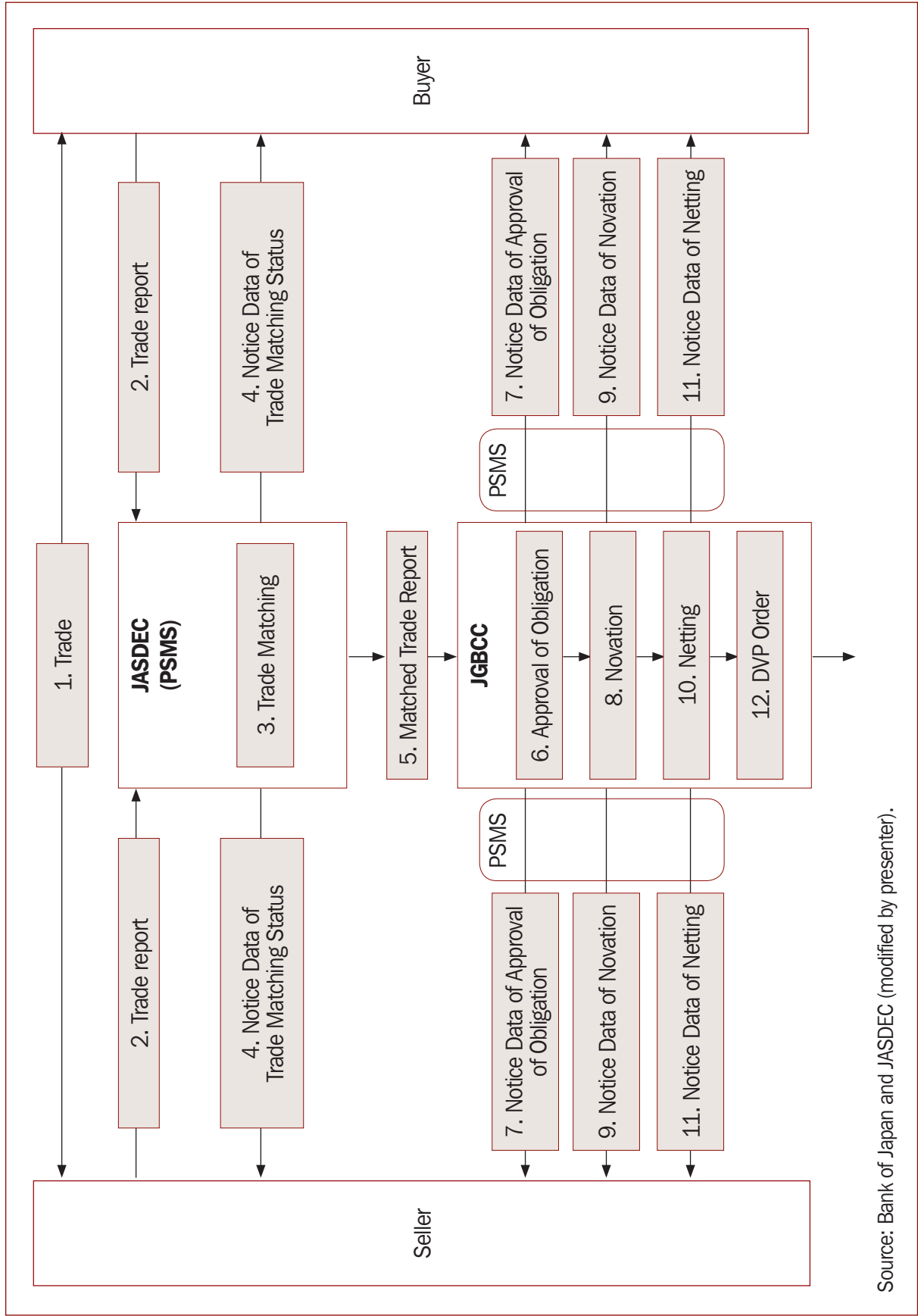

Source: Bank of Japan and JASDEC (modified by presenter).

Figure 5. JPN Bond Transaction Flow OTC Market (JGB)/DVP (New BOJ-NET) through Trade Matching (PSMS) and JGBCC (2/2)

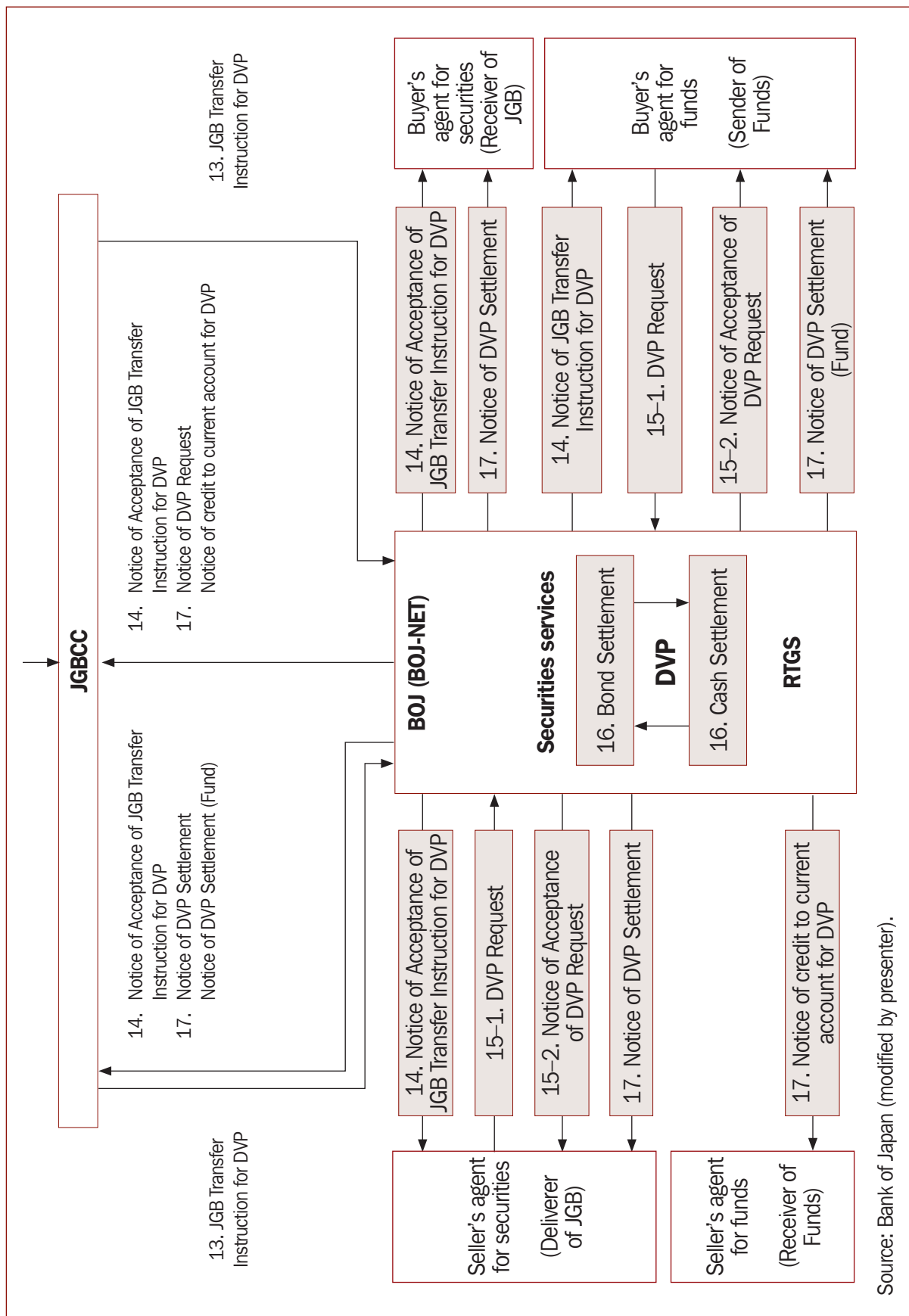

Note: Description of JPN Bond Transaction Flow OTC Market (JGB)/DVP (New BOJ-NET) through Trade Matching (PSMS) and JGBCC

1. The seller and buyer trade government bond over-the-counter.
2. Both seller and buyer key in Trade Report data into PSMS (Pre-Settlement Matching System).
3. PSMS performs trade matching.
4. PSMS sends the Notice Data of Trade Matching Status to both sides of trade.
5. PSMS transmits the message of Matched Trade Report data to JGBCC.
6. JGBCC makes approval of obligation.
7. JGBCC sends the Notice Data of Approval of Obligation to the seller and buyer via PSMS.
8. JGBCC performs the novation.
9. JGBCC sends the Notice Data of Novation to the seller and buyer via PSMS.
10. JGBCC performs the netting.
11. JGBCC sends the Notice Data of Netting to the seller and buyer via PSMS.
12. JGBCC compiles DVP order.
13. JGBCC sends the JGB Transfer Instruction for DVP to BOJ-NET.
14. BOJ-NET sends the Notice of Acceptance of JGB Transfer Instruction for DVP to the seller, the buyer and JGBCC.
- 15-1. The seller/the buyer enters DVP Request to BOJ-NET.
- 15-2. BOJ-NET sends the Notice of Acceptance of DVP Request to the seller / the buyer and completes settlement.
16. BOJ-NET performs security and cash settlement.
17. When DVP settlement completed, BOJ-NET sends the Notice of DVP settlement to the buyer and JGBCC and BOJ-NET sends the Notice of credit to current account for DVP to the seller and JGBCC.

Source: ABMF SF2.

Figure 6. JPN Bond Transaction Flow OTC Market (Corporate Bonds)/DVP (BOJ-NET) through Trade Matching (PSMS)

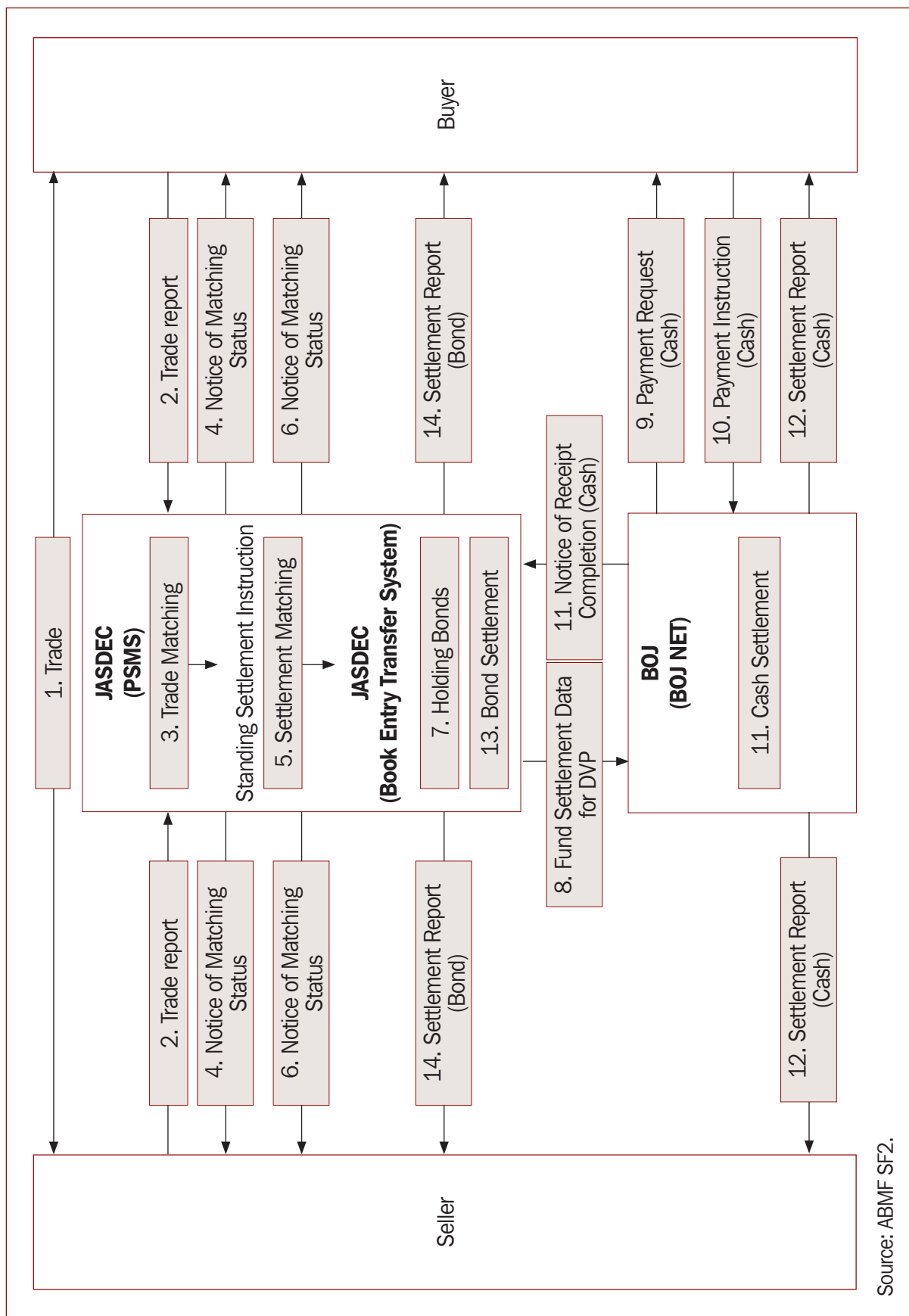

Source: ABMIF SF2.

Figure 7. JPN Bond Transaction Flow OTC Market (JGB)/DVP other types of Trade Matching (PSMS) (1/2)

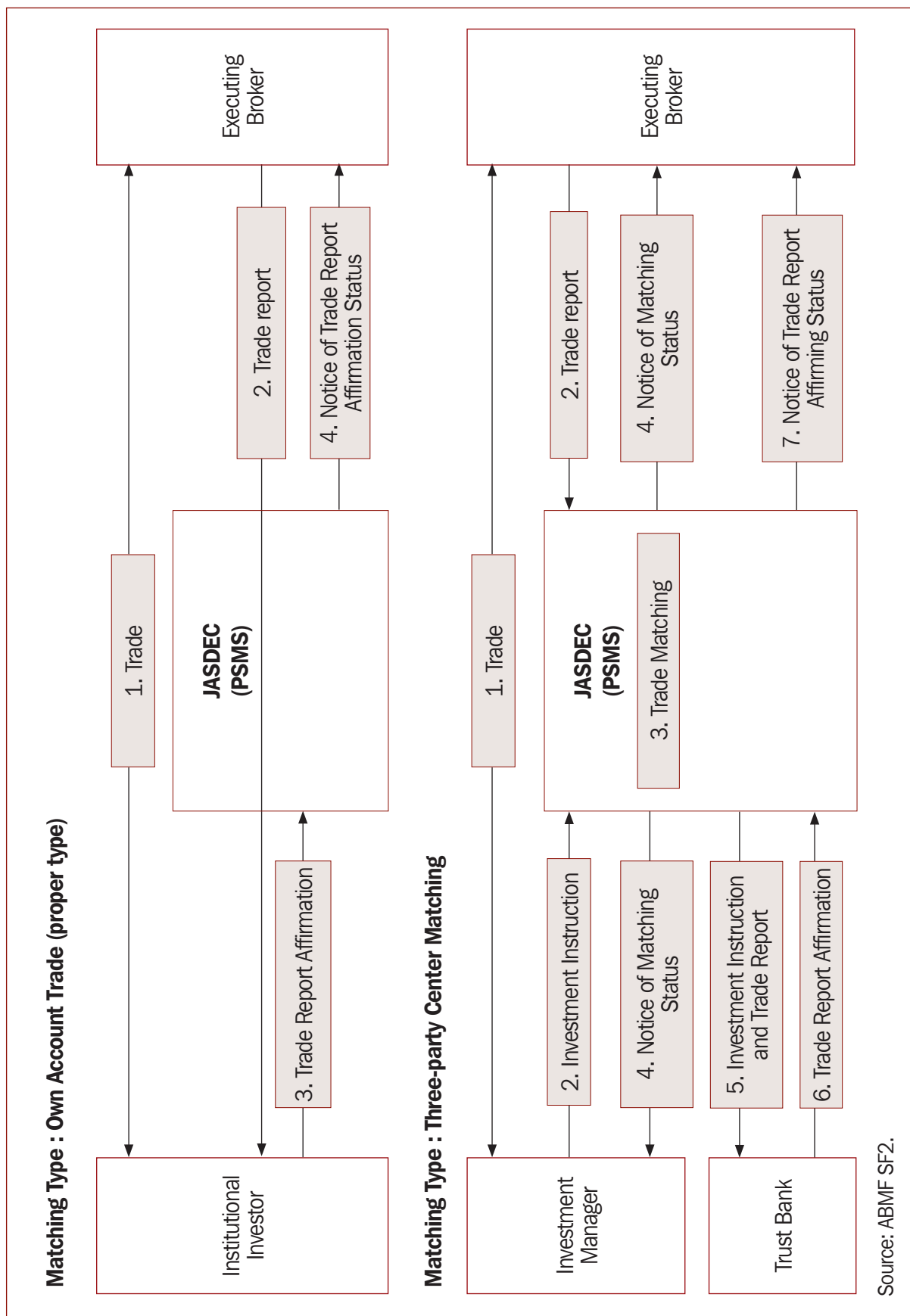
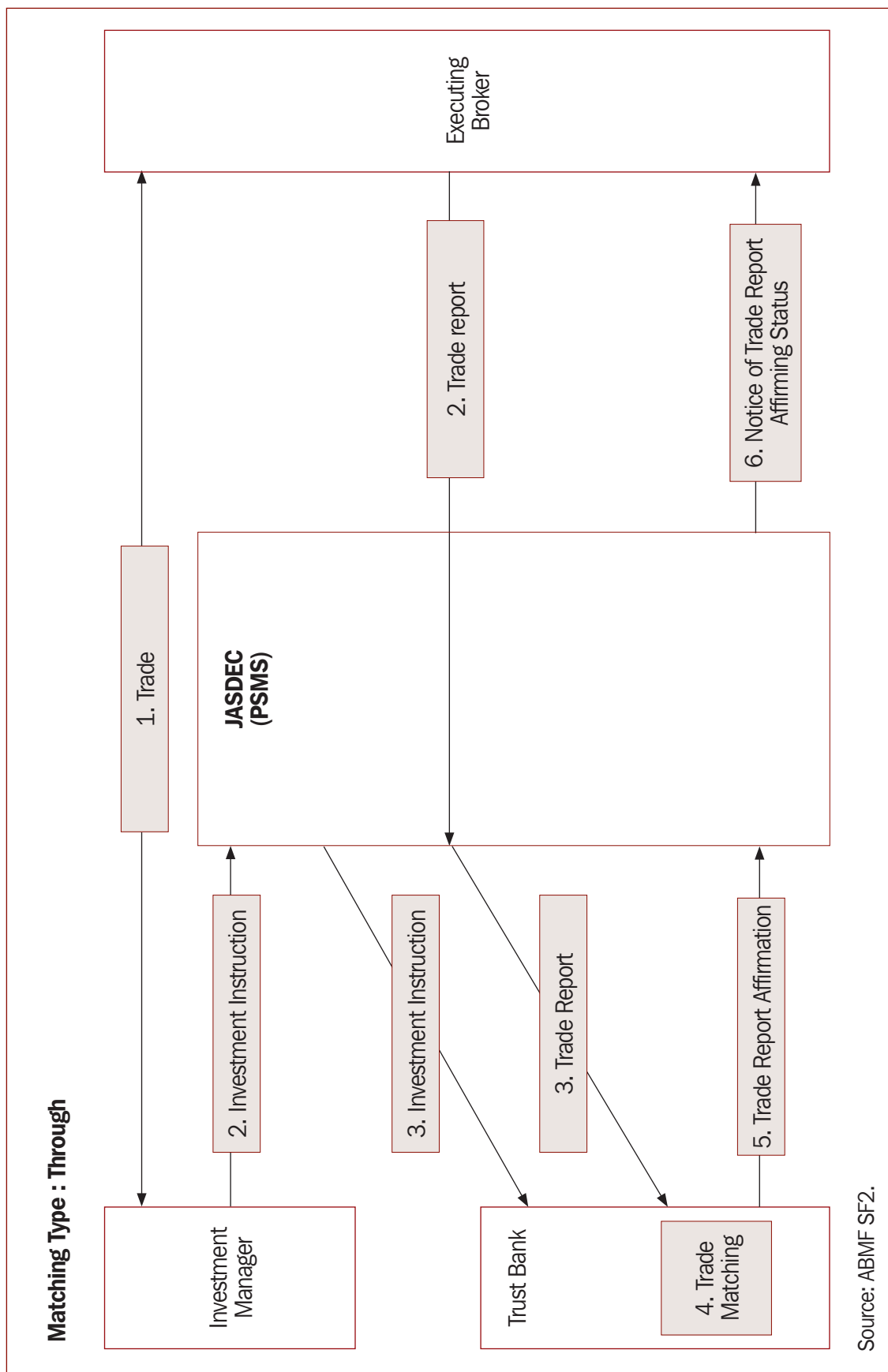

Figure 7. JPN Bond Transaction Flow OTC Market (JGB)/DVP other types of Trade Matching (PSMS) (2/2)



Republic of Korea (KOR)

Bond Market Infrastructures and Bond Transaction Flow

Figure 1. KOR Bond Market Infrastructure Diagram

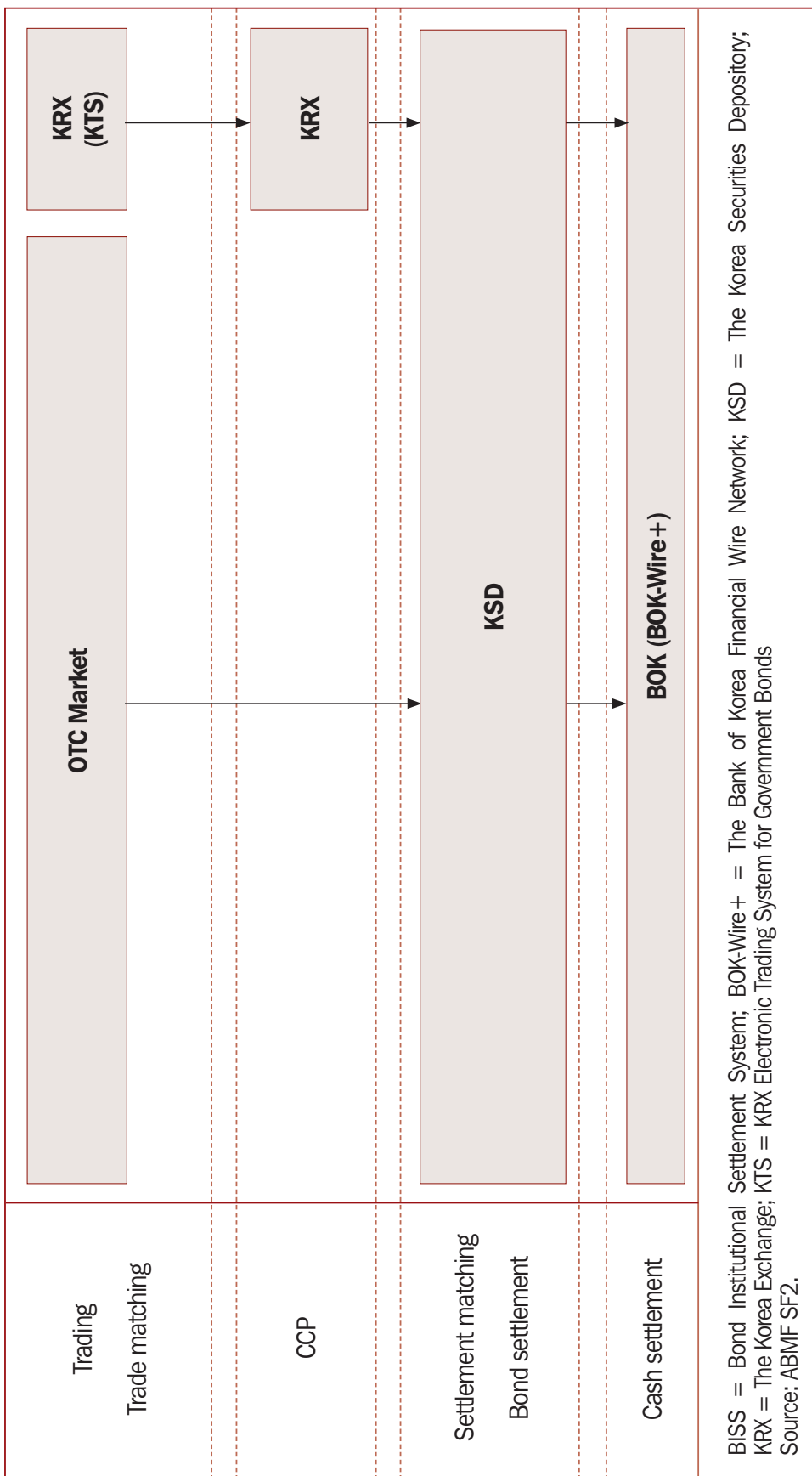
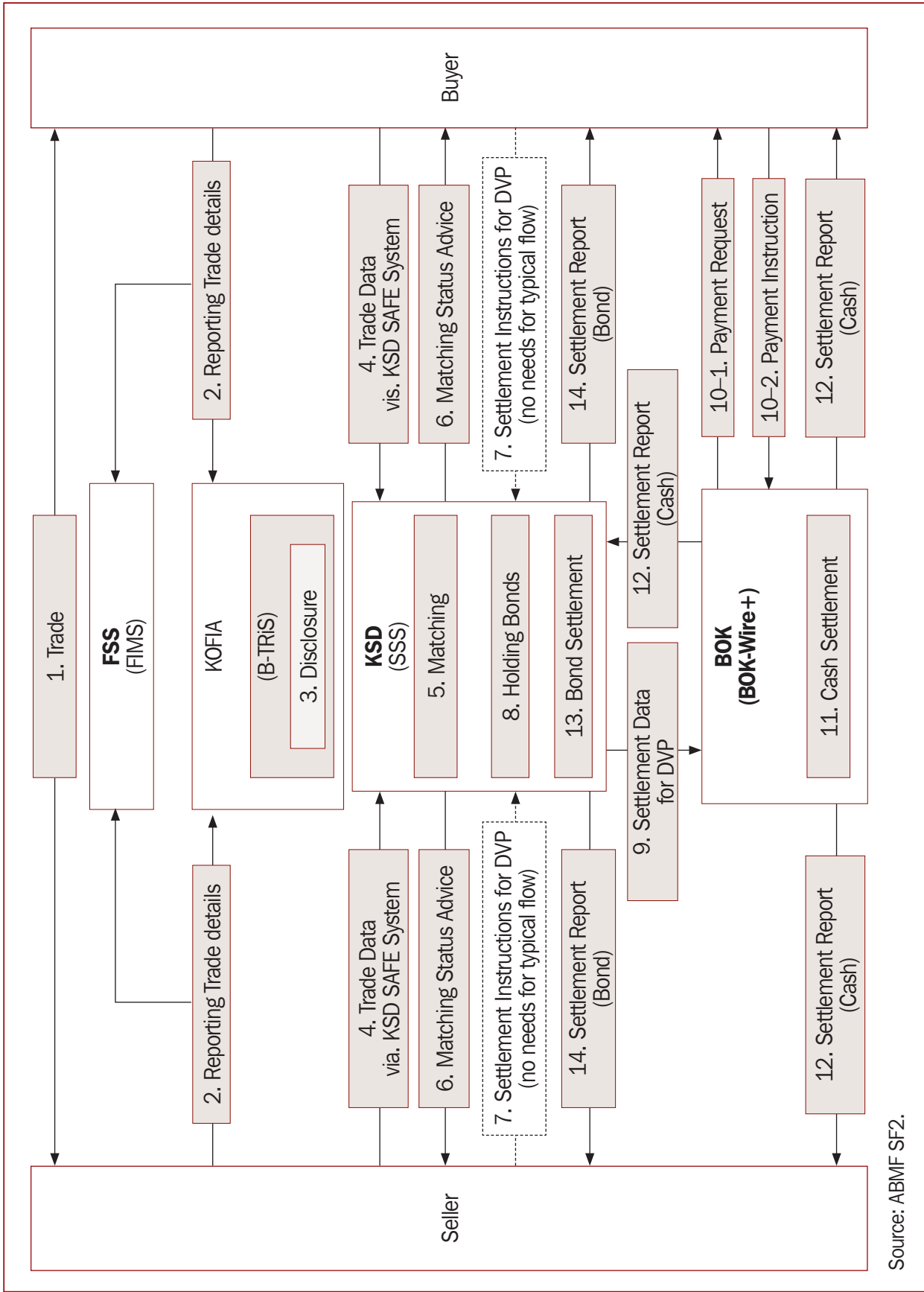

Figure 2. KOR Bond Transaction Flow for Domestic Trades OTC Market/DVP



Source: ABMIF SF2.

Note: Description of KOR Bond Transaction Flow for Domestic Trades OTC Market/DVP

1. The seller and buyer trade over the counter mostly with private messenger, and some transactions are done with FreeBond provided by KOFIA which is a supporting and confirmation system for bond trading.
2. Financial investment companies engaged in trading must report trading details to the KOFIA within 15 minutes after trading execution. They also report trading details to FSS via Foreign Investment Management System (FIMS).
3. KOFIA discloses this information on its Bond-Trade Report and Information Service (B-TRIs).
4. The seller and buyer send trade data to Korea Securities Depository (KSD).
5. KSD collates trade data from the seller and buyer.
6. KSD sends matching status advise to the seller and buyer.
7. The seller and buyer send settlement instructions for DVP to KSD.
8. KSD holds bonds before cash settlement.
9. KSD sends settlement data to Bank of Korea (BOK).
- 10-1. The BOK sends payment request (cash) to the buyer.
- 10-2. The buyer sends the payment instruction for DVP to the BOK.
11. BOK executes cash settlement.
12. BOK sends settlement report to the KSD.
13. KSD executes bond settlement.
14. KSD sends settlement report to the seller and buyer.

Source: ABMF SF2.

Figure 3. KOR Bond Transaction Flow for Domestic Trades Exchange Market/DVP

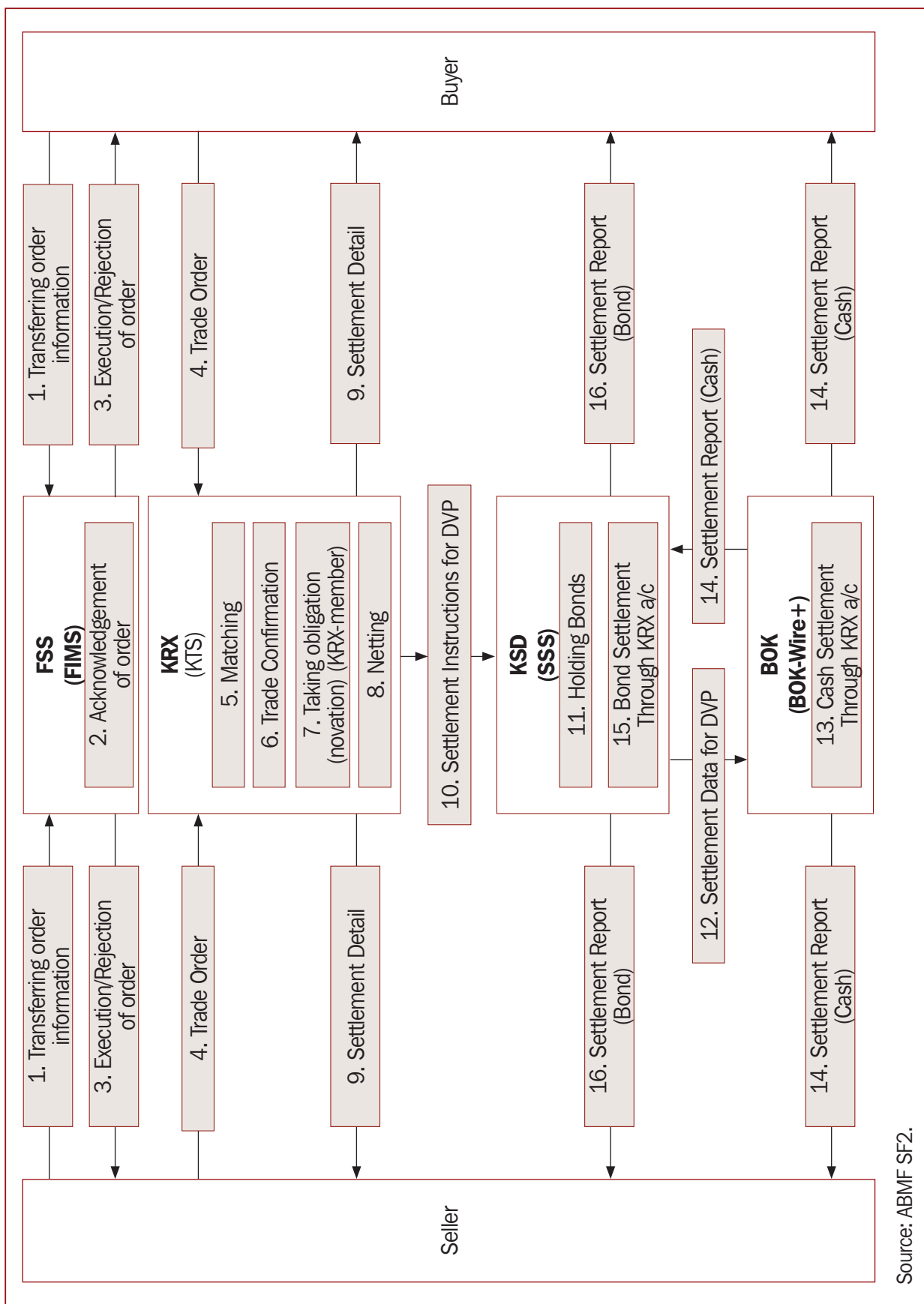

Source: ABMF SF2.

Note: Description of KOR Bond Transaction Flow for Foreign Investors OTC Market/DVP

Trade Date

1. Foreign Institutional Investor places order with International Broker.
2. International Broker places order with Domestic Broker/Bank.
3. Domestic Broker/Bank trades OTC with Counterparty (via phone or e.g. Bloomberg).
4. Domestic Broker/Bank and Counterparty report trade to KOFIA within 15 minutes of trade.
5. Domestic Broker/Bank send trade confirmation to International Broker.
6. Domestic Broker/Bank sends trade details to KSD.
7. Foreign Institutional Investor receives trade confirmation.

T+1 (SD-1)

8. Foreign Institutional Investor instructs Global Custodian on securities settlement details, and FX/funding.
9. Global Custodian instructs Domestic Custodian on (a) securities settlement details, and (b) FX/funding requirements.
10. KSD sends Preliminary Settlement Data to Domestic Custodian, via SAFE.
11. Domestic Custodian affirms settlement details.
12. KSD sends affirmation status to Domestic Broker/Bank.
13. Domestic Custodian reports transaction status update to Global Custodian.
14. Domestic Custodian sends FX confirmation to Global Custodian.

Settlement Date

15. Domestic Custodian funds BOK account.
16. Upon transfer of cash, BOK sends settlement confirmation to Domestic Custodian.
17. Upon transfer of securities, KSD sends settlement confirmation to Domestic Custodian.
18. Domestic Custodian sends settlement confirmation to Global Custodian.
19. Global Custodian funds account with Domestic Custodian, or into FCY nostro (before end of day).
20. Global Custodian sends settlement confirmation to Foreign Institutional Investor.
21. Domestic Custodian sends securities statement to Global Custodian.
22. Domestic Custodian sends cash credit/debit confirmation in cash statement to Global Custodian.
23. Global Custodian sends credit/debit confirmation in cash statement to Foreign Institutional Investor.

Source: ABMF SF2.

Malaysia (MAL)

Bond Market Infrastructures
and Bond Transaction Flow

Figure 1. MAL Bond Market Infrastructure Diagram

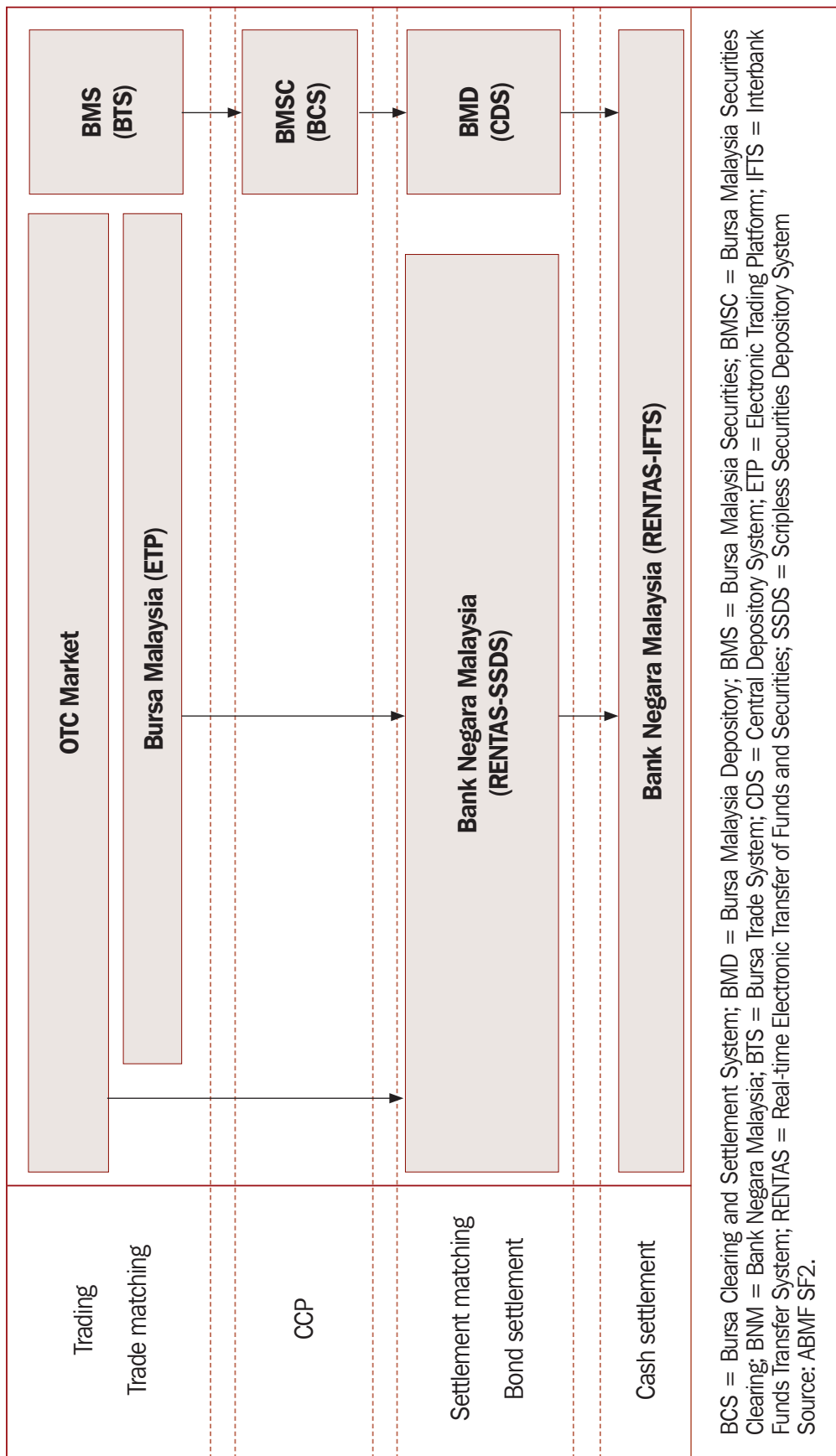
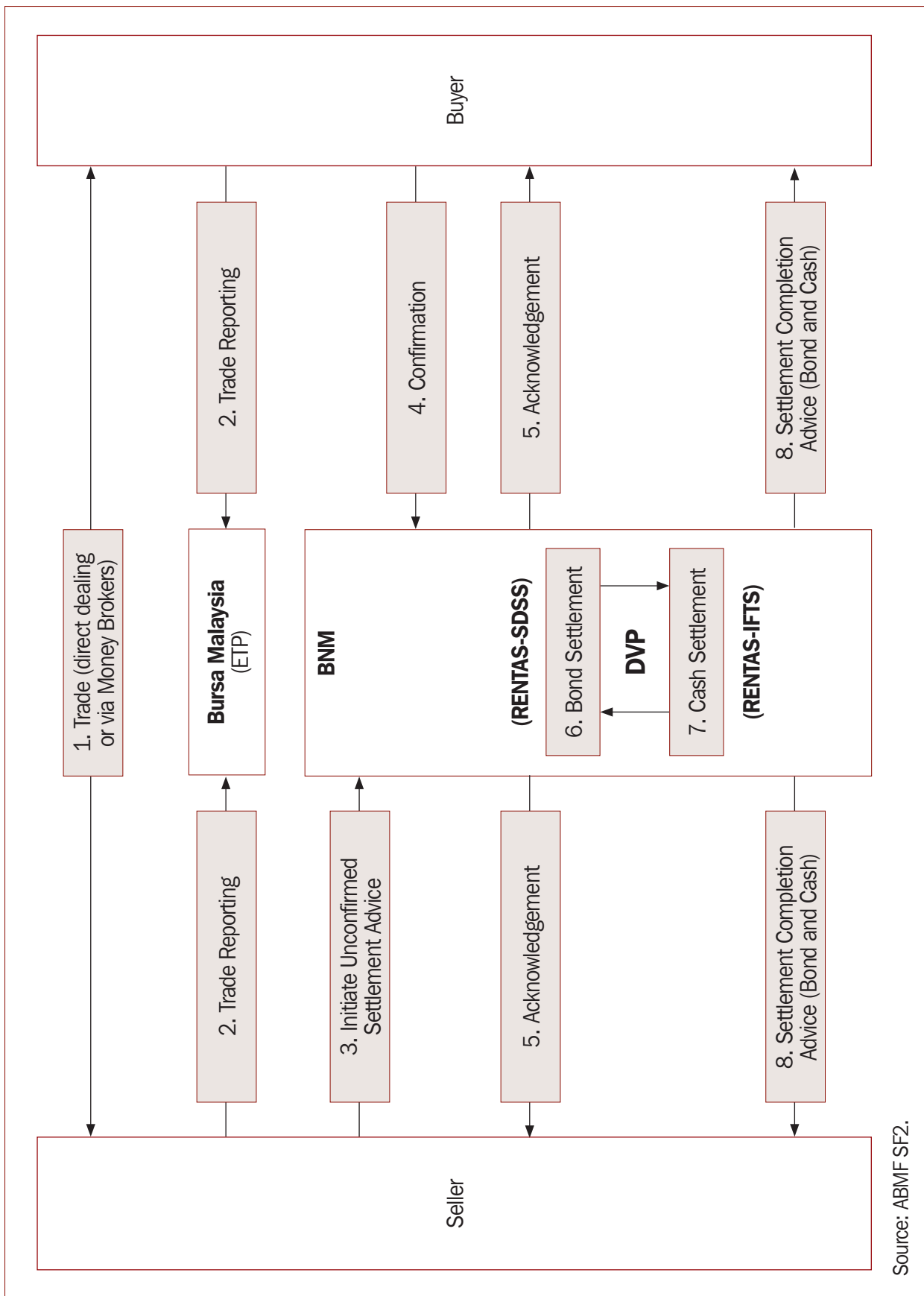

Figure 2. MAL Bond Transaction Flow for Domestic Trades OTC Market/DVP



Source: ABMIF SF2.

Note: Description of MAL Bond Transaction Flow for Domestic Trades OTC Market/DVP**OTC Market**

1. The seller and buyer trade over the counter by telephone (direct dealing or through Money Broker). 95% of bond trades are dealt in OTC market. Commercial banks and Islamic banks can trade the bonds.
2. All trades are recorded in Electronic Trading Platform (ETP).
3. The seller (or Buyer) input trade data into RENTAS as initiate unconfirmed settlement advice.
4. The Buyer (or Seller) confirms an unconfirmed settlement advice using by Confirmation menu of RENTAS.
5. The seller and buyer access Report menu of RENTAS and confirm that confirmation of local matching is performed.
6. 7. On settlement date, bond and cash are settled on DVP basis.
8. The seller and buyer access Report menu of RENTAS and confirm report of Bond settlement and cash settlement.

Source: ABMIF SF2.

Figure 3. MAL Bond Transaction Flow for Foreign Investors OTC Market/DVP

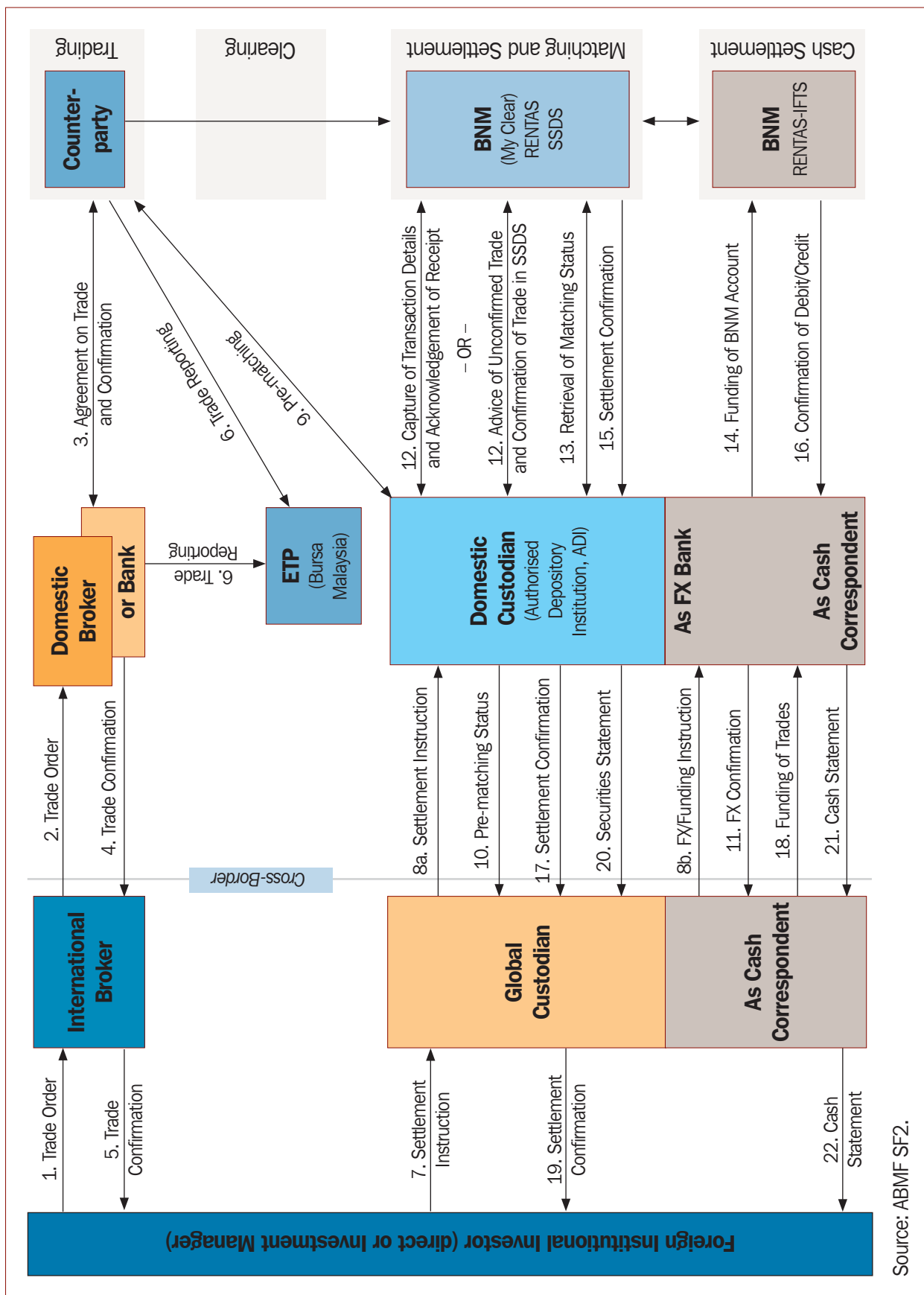

Note: Description of MAL Bond Transaction Flow for Foreign Investors OTC Market/DVP

Trade Date

1. Foreign Institutional Investor places order with International Broker.
2. International Broker places order with Domestic Broker/Bank.
3. Domestic Broker/Bank and Counterparty agrees on OTC trade (via e.g., phone or Bloomberg).
4. Domestic Broker/Bank sends trade confirmation to International Broker.
5. Foreign Institutional Investor receives trade confirmation.
6. Domestic Broker/Bank and Counterparty capture trade in ETP, by end of trading day.

T+1

7. Foreign Institutional Investor instructs Global Custodian, on securities settlement and cash/funding details.
8. Global Custodian instructs Domestic Custodian/ADI on (a) securities settlement details, (b) FX request or funding details.
9. Domestic Custodian/ADI and Counterparty pre-match settlement details, via phone.
10. Domestic Custodian/ADI sends pre-matching result information (e.g., missing instructions) to Global Custodian.
11. Domestic Custodian/ADI provides confirmation of FX booked (in case of earlier FX request).

Settlement Date

12. Domestic Custodian/ADI captures settlement details into SSDS and receives SSDS acknowledgment of receipt of data (selling side), OR receives alleged trade notice (advice of unconfirmed trade) from SSDS and confirms settlement details in SSDS (buying side).
13. Domestic Custodian/ADI retrieves settlement matching status.
14. Domestic Custodian/ADI effects funding of its account at Bank Negara Malaysia (BNM) via RENTAS (IFTS) if necessary.
15. Upon settling securities, SSDS sends settlement confirmation for securities to Domestic Custodian/ADI.
16. Upon settling cash, RENTAS sends debit/credit confirmation to Domestic Custodian/ADI.
17. Domestic Custodian/ADI sends settlement confirmation to Global Custodian.
18. Global Custodian funds account with Domestic Custodian/ADI (before end of day).
19. Global Custodian sends settlement confirmation to Foreign Institutional Investor.
20. Domestic Custodian/ADI sends statement of securities to Global Custodian (at end of day).
21. Domestic Custodian/ADI sends debit/credit information in cash statement (at end of day).
22. Global Custodian sends debit/credit information in cash statement to FI (at end of day).

Source: ABMF SF2.

Philippines (PHI)

Bond Market Infrastructures and Bond Transaction Flow

Figure 1. PHI Bond Market Infrastructure Diagram

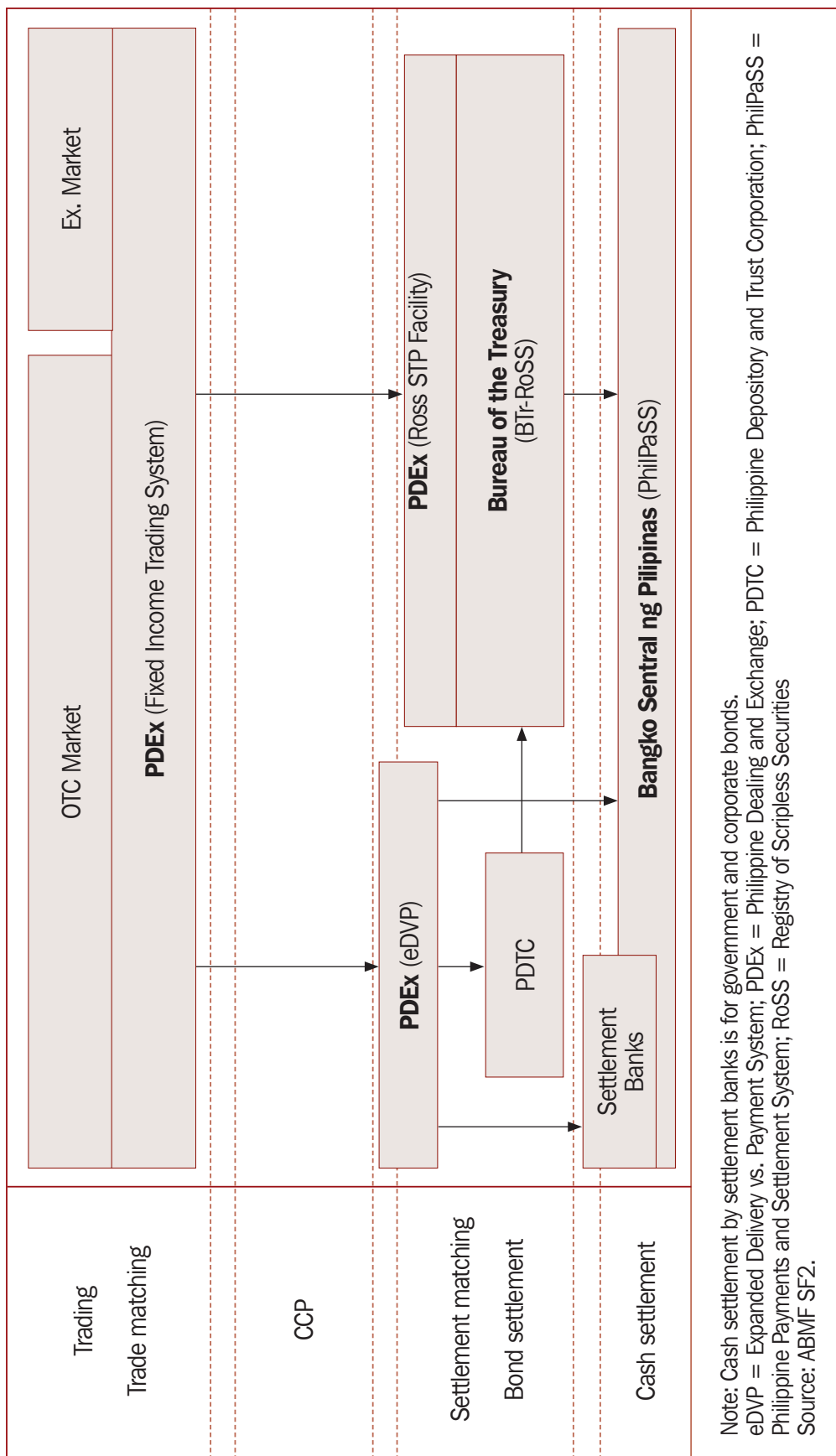
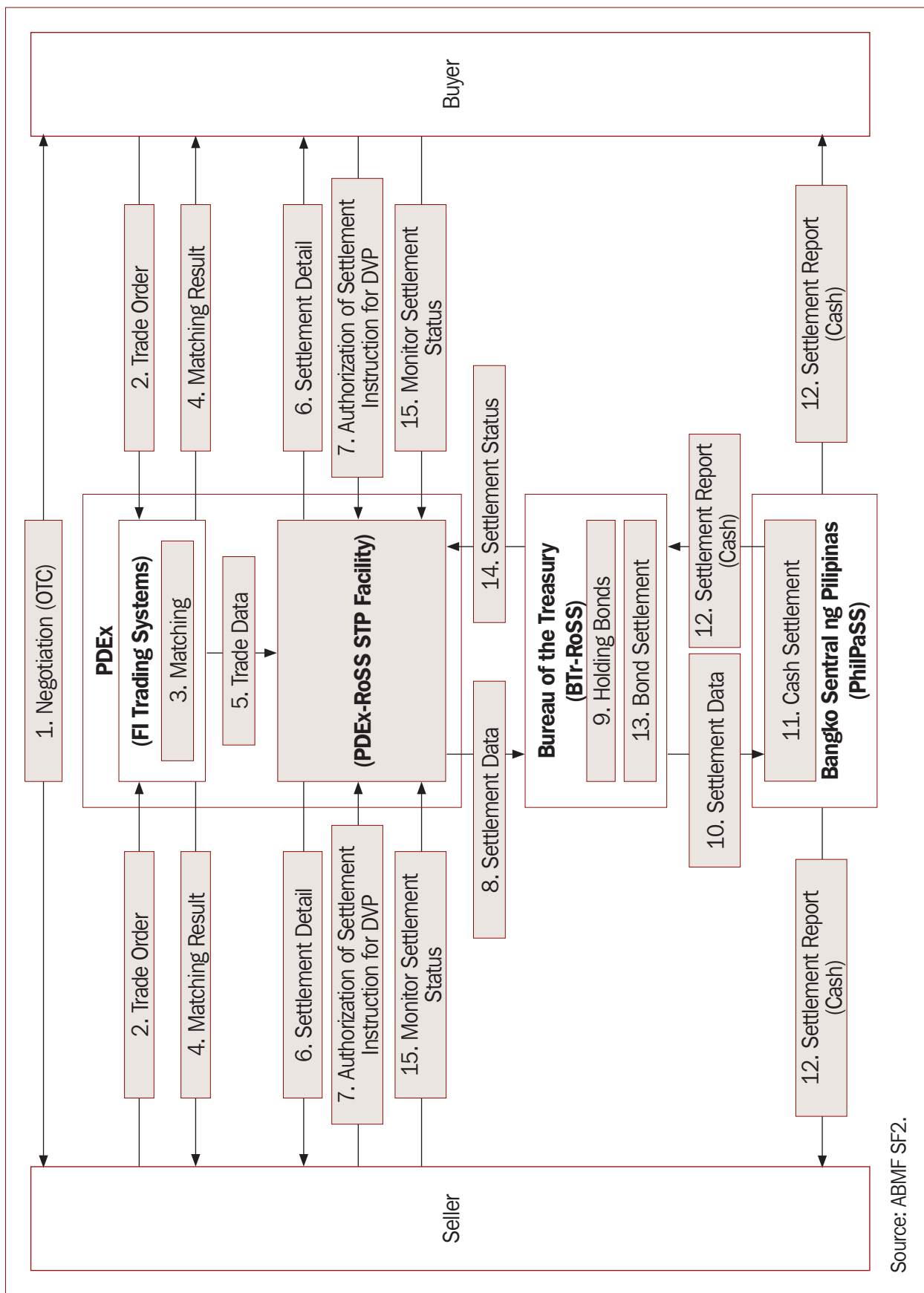

Figure 2. PHI Bond Transaction Flow for Domestic Trades GSEDs Market/DVP



Source: ABMF SF2.

Note: Description of PHI Bond Transaction Flow for Domestic Trades GSEDS* Market/DVP

GSEDS

1. In OTC market, the seller and buyer negotiate before they input the trade data to PDEX. This process is omitted in the Exchange Market.
2. The seller and buyer trade via PDEX(FI Trading System).
3. PDEX(FI Trading System) matches order or records negotiated deals between buyer and seller.
4. PDEX(FI Trading System) sends matching result to the seller and buyer.
5. PDEX(FI Trading System) sends trade data to PDEX(PDEX-RoSS STP Facility).
6. PDEX(PDEX-RoSS STP Facility) sends settlement detail to the seller and buyer.
7. The seller and buyer authorize the settlement instruction for DVP.
8. PDEX(PDEX-RoSS STP Facility) sends settlement data to Bureau of the Treasury Registry of Scripless Securities (BTr-RoSS).
9. BTr-RoSS holds bonds before cash settlement.
10. BTr-RoSS sends settlement data to Bangko Sentral ng Pilipinas (BSP).
11. BSP executes cash settlement.
12. BSP sends cash settlement report to seller, buyer and BTr-RoSS.
13. BTr-RoSS executes bond settlement.
14. BTr-RoSS sends bond settlement status to PDEX-RoSS STP Facility.
15. The seller and the buyer can monitor settlement status via PDEX-RoSS STP Facility.

*GSED = Government Securities Eligible Dealer
Source: ABMF-SF2.

Figure 3. PHI Bond Transaction Flow for Domestic Trades Non-GSEs Market/DVP

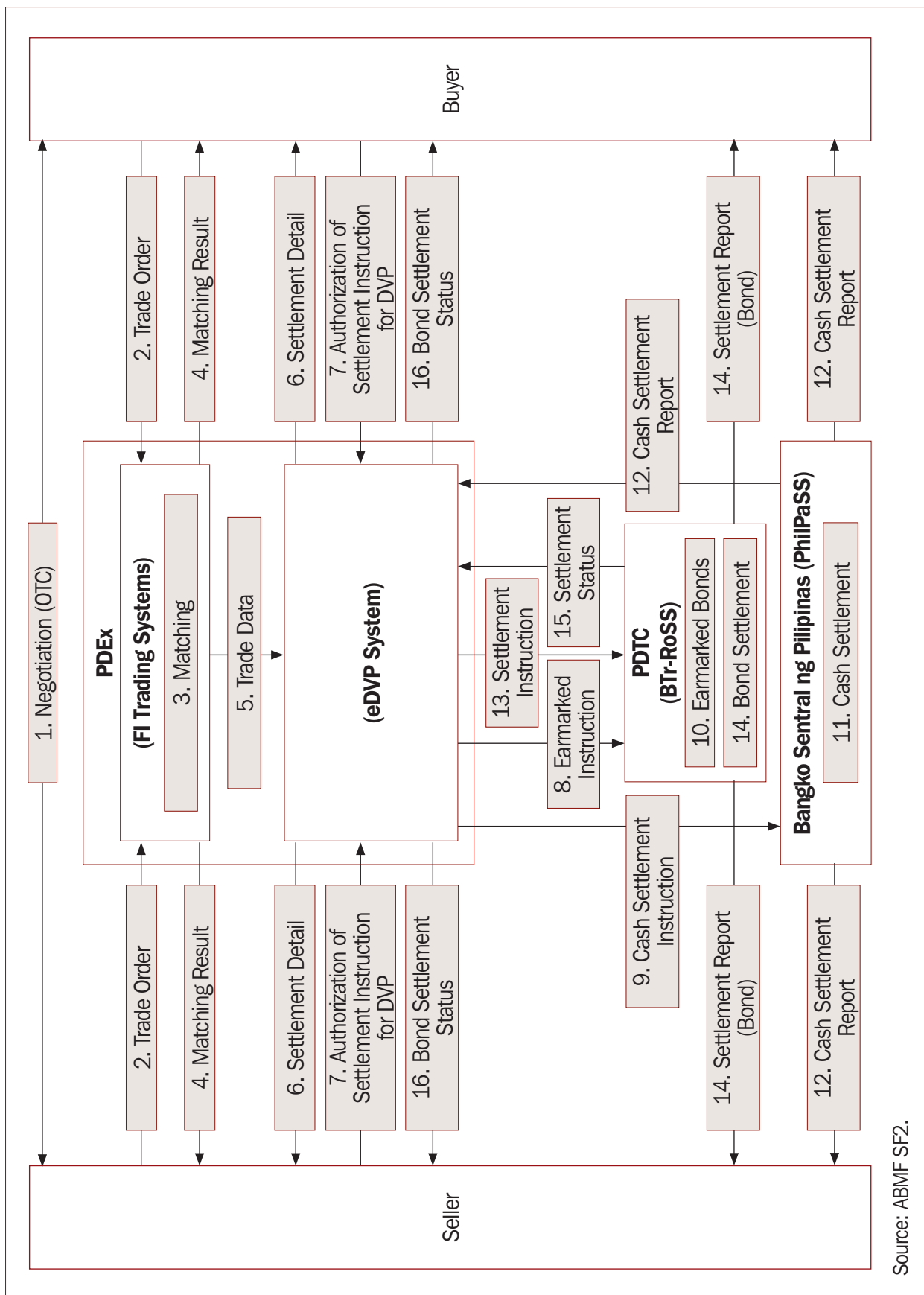

Source: ABMF SF2.

Note: Description of PHI Bond Transaction Flow for Domestic Trades Non-GSEDS* Market/DVP

Non-GSEDS

1. In OTC market, the seller and buyer negotiate before they input the trade data to PDEX. This process is omitted in the Exchange Market.
2. The seller and buyer trade via PDEX(FI Trading System).
3. PDEX (FI Trading System) automatically matches orders from seller and buyer.
4. PDEX (FI Trading System) sends matching results to the seller and buyer.
5. PDEX (FI Trading System) sends trade data to PDEX (eDVP System).
6. PDEX (eDVP System) sends settlement details to the seller and buyer.
7. The seller and buyer authorize the settlement instruction for DVP.
8. PDEX (eDVP System) sends earmarked instruction to PDTC.
9. PDEX (eDVP System) sends cash settlement instruction to BSP.
10. PDTC and BTr-RoSS holds bonds before cash settlement. PDTC acts as sub-registry.
11. BSP executes cash settlement.
12. BSP sends cash settlement report to the seller, buyer, and PDEX (eDVP System).
13. PDEX (eDVP System) sends settlement instruction to Philippine Depository and Trust Corp (PDTC) and BTr-RoSS.
14. PDTC and BTr-RoSS executes bond settlement.
15. PDTC and BTr-RoSS sends settlement status to PDEX (eDVP System).
16. PDEX (eDVP System) sends bond settlement status to the seller and buyer.

*GSED = Government Securities Eligible Dealer
Source: ABMF SF2.

Figure 4. PHI Bond Transaction Flow for Foreign Investors OTC Market/DVP

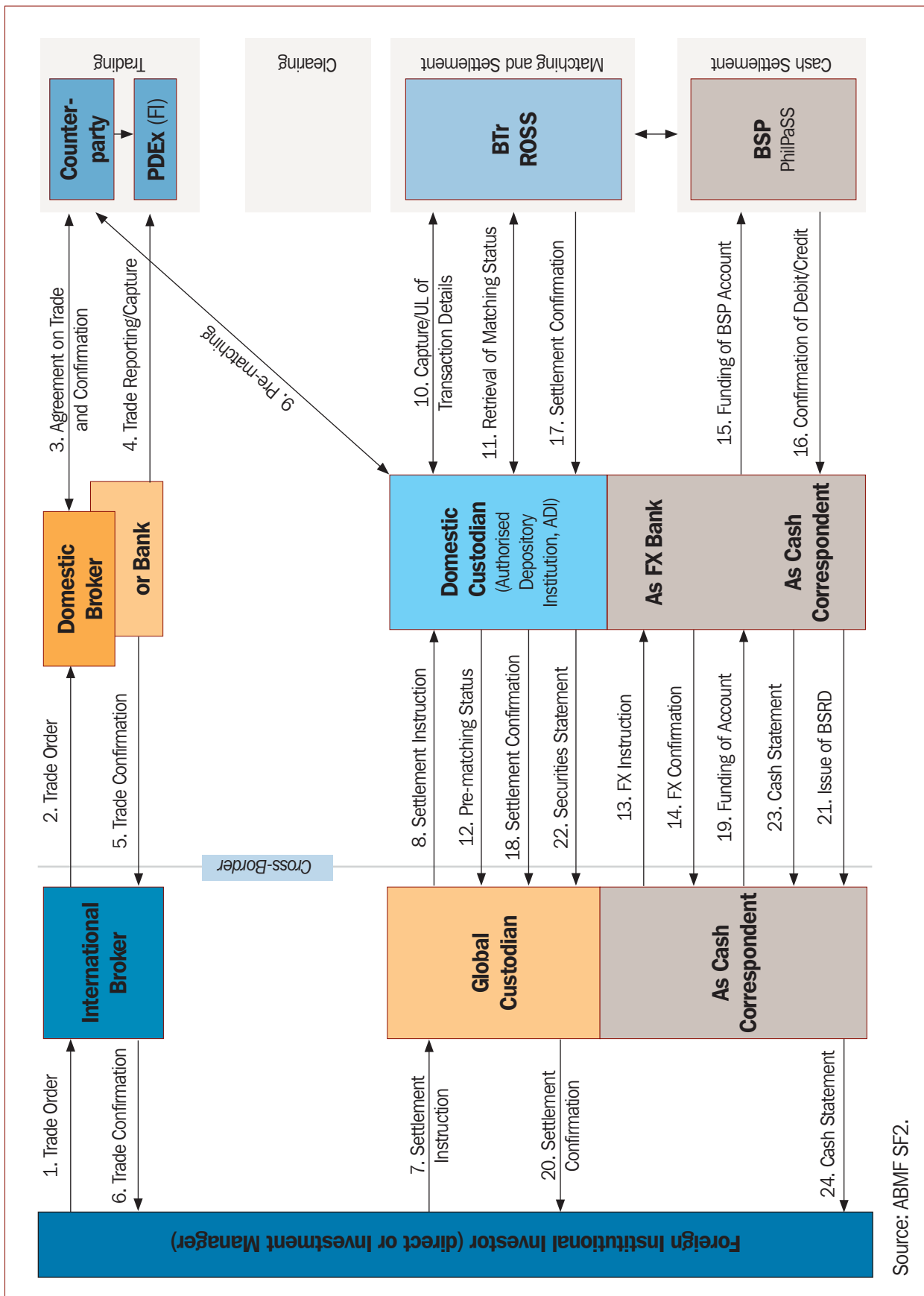

Note: Description of PHI Bond Transaction Flow for Foreign Investors OTC Market/DVP

Trade Date

1. Foreign Institutional Investor places order with International Broker.
2. International Broker places order with Domestic Broker/GSED.
3. Domestic Broker or Dealer trades OTC with Counterparty.
4. Domestic Broker or Dealer captures trade in PDEX system, for price discovery, within 10 minutes.
5. International Broker receives trade confirmation.
6. Foreign Institutional Investor receives trade confirmation.

T+1

7. Foreign Institutional Investor instructs Global Custodian, on securities settlement and FX/cash funding details.
8. Global Custodian instructs Domestic Custodian on securities settlement details.
9. Domestic Custodian conducts phone pre-matching with Counterparty or custodian of counterparty.

Settlement Date

10. Domestic Custodian enters settlement data into BIT-RoSS.
11. Domestic Custodian retrieves transaction matching status.
12. Domestic Custodian reports matching status update to Global Custodian.
13. Global Custodian sends FX instruction for projected funding requirements.
14. Domestic Custodian sends FX confirmation.
15. Domestic Custodian funds BSP accounts, via PhilPASS (RTGS) if necessary.
16. Upon transfer of cash (after prompting from BIT-RoSS), PhilPaSS sends cash settlement confirmation to Domestic Custodian.
17. Upon confirmation of cash settlement, BIT-RoSS effects bond settlement, sends confirmation to Domestic Custodian.
18. Domestic Custodian sends settlement confirmation to Global Custodian.
19. Global Custodian funds account with Domestic Custodian in PHP, or into FCY nostro (before end of day).
20. Global Custodian sends settlement confirmation to Foreign Institutional Investor.
21. Domestic Custodian issues BSRD (Bangko Sentral Remittance Document), certifying FCY inflow for ability to repatriate at later stage without consideration of FX limitations.
22. Domestic Custodian sends securities statement to Global Custodian.
23. Domestic Custodian sends debit/credit confirmations, in form of cash statement, to Global Custodian.
24. Global Custodian sends cash statement to Foreign Institutional Investor.

Source: ABMF SF2.

Singapore (SIN)

Bond Market Infrastructures
and Bond Transaction Flow

Figure 1. SIN Bond Market Infrastructure Diagram

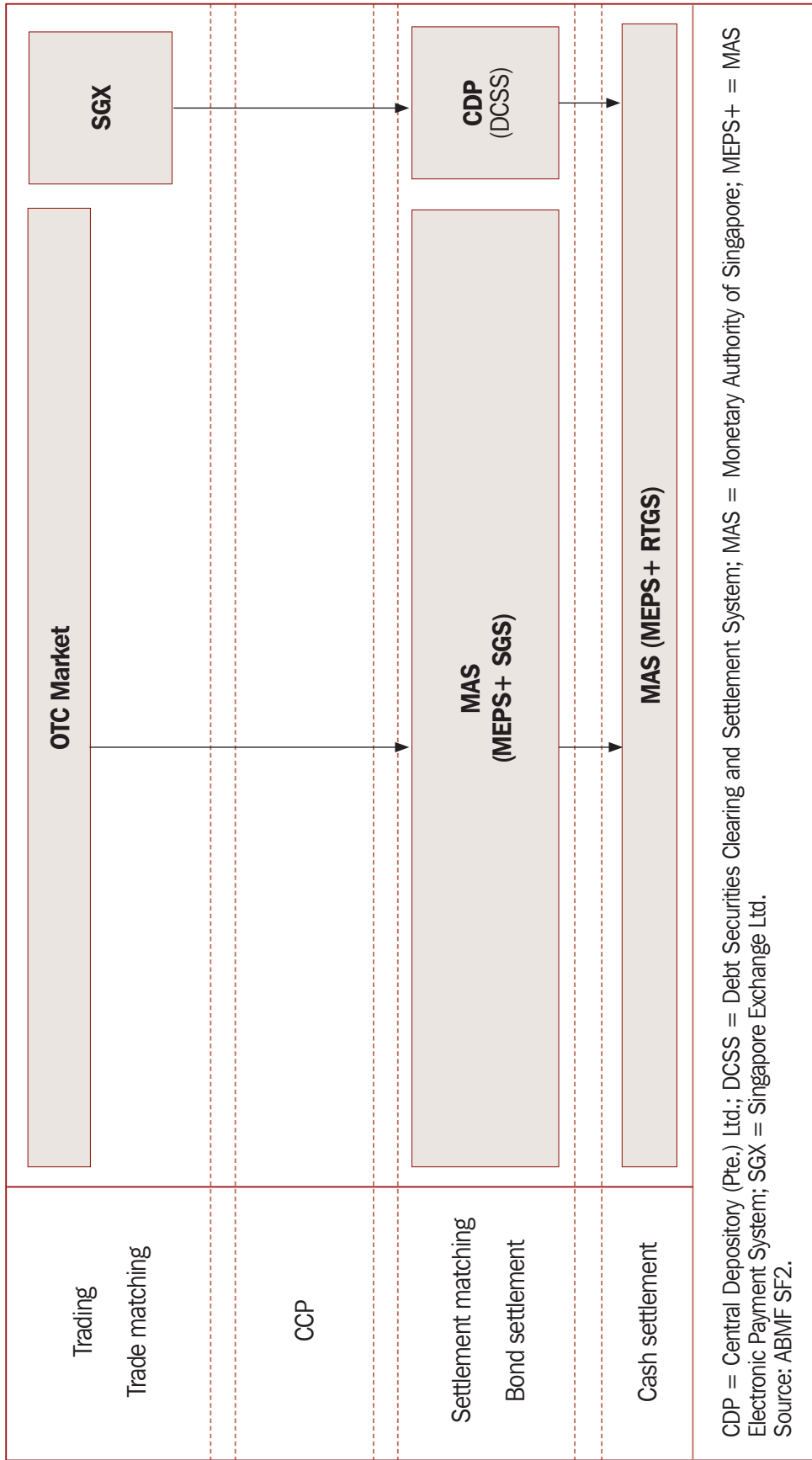
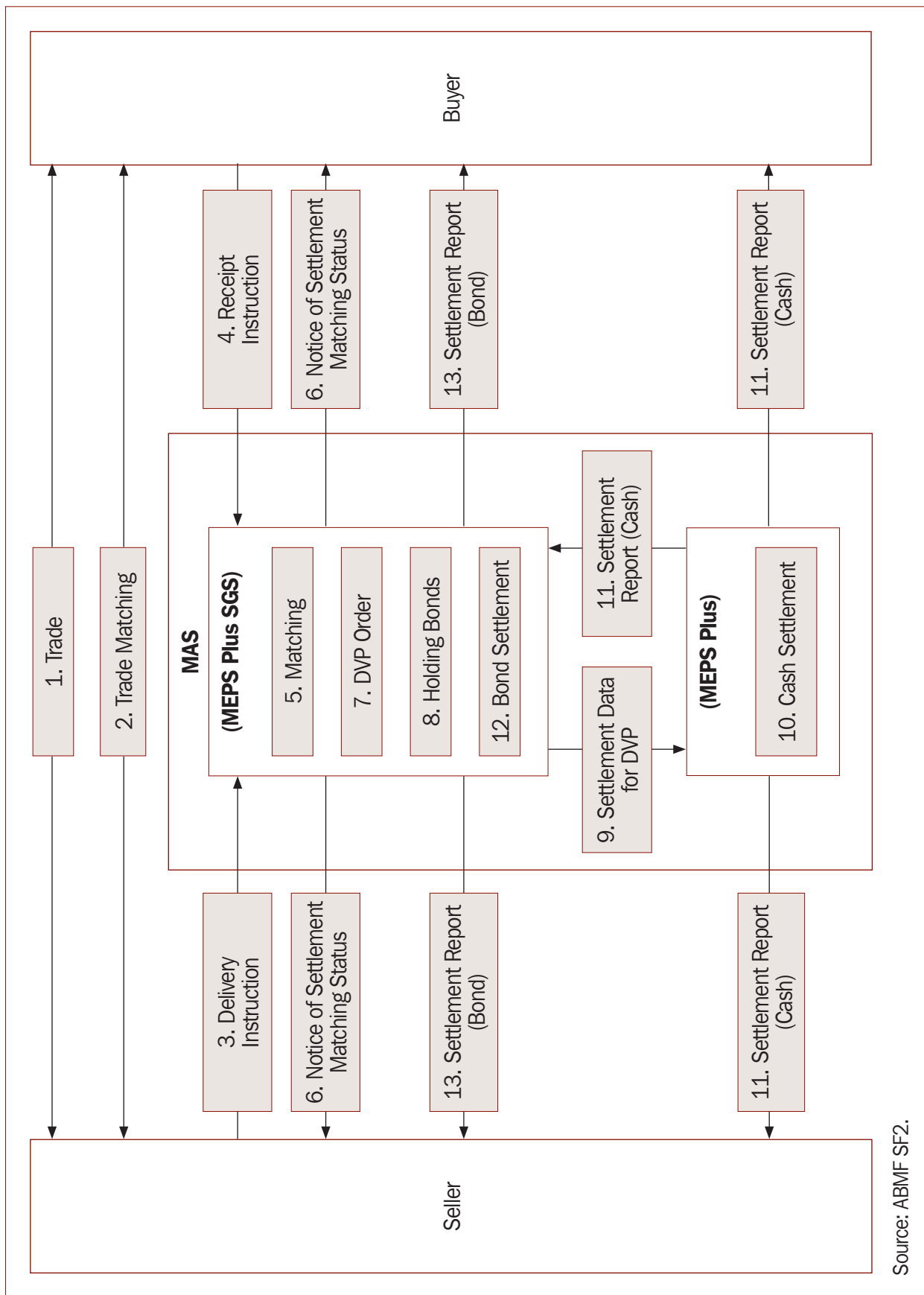

Figure 2. SIN Bond Transaction Flow for Domestic Trades OTC Market/DVP



Source: ABMIF SF2.

Note: Description of SIN Bond Transaction Flow for Domestic Trades OTC Market/DVP

1. SGS (Singapore government securities) is done on an over-the-counter basis.
2. Trades are matched among seller and buyer.
3. The bond seller sends the agreed trade instruction to MEPS+ SGS.
4. The bond buyer sends the agreed trade instruction to MEPS+ SGS.
5. MEPS+ SGS performs bond matching.
6. MEPS+ SGS sends the notice of bond matching status to seller and buyer.
7. MEPS Plus Book-entry clearing system creates the DVP order.
8. When the seller's SGS account has sufficient SGS, the SGS are earmarked for transfer to the buyer.
9. Settlement data for DVP is sent to MEPS+ RTGS.
10. When the funds are available, the amount is debited from the buyer's RTGS account and credited to the seller's RTGS account.
11. MEPS+ RTGS simultaneously MEPS+ SGS to transfer the securities and report the cash settlement status to both sides of the trade.
12. MEPS+ SGS transfers the bonds to the buyer's account.
13. MEPS+ SGS reports the settlement status to both seller and buyer.

Source: ABMF SF2.

Figure 3. SIN Bond Transaction Flow for Foreign Investors OTC Market/DVP

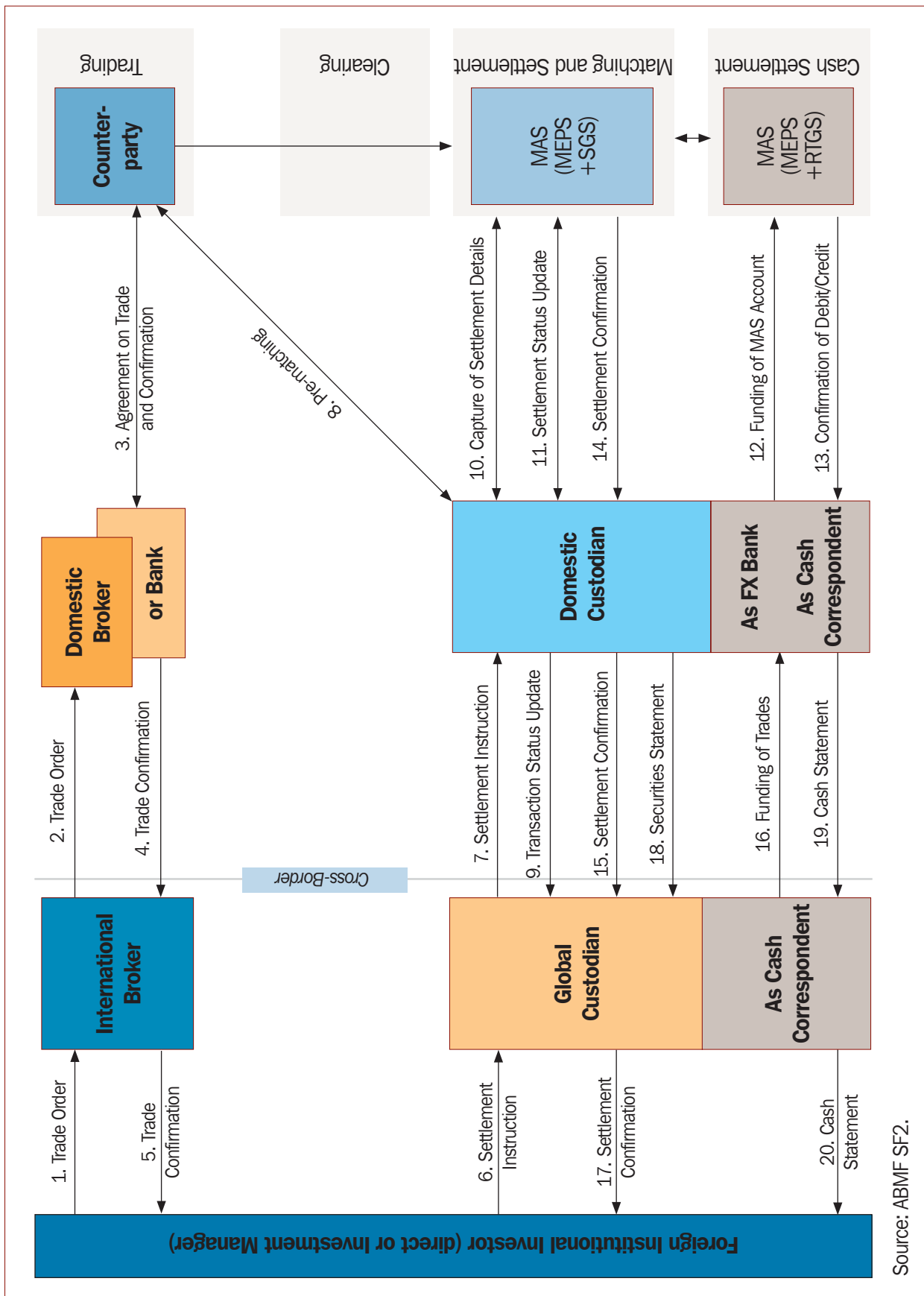

Note: Description of SIN Bond Transaction Flow for Foreign Investors OTC Market/DVP

Trade Date

1. Foreign Institutional Investor places order with International Broker.
2. International Broker places order with Domestic Broker or Bank.
3. Domestic Broker/Bank trades OTC with Counterparty (via phone, Bloomberg).
4. Domestic Broker/Bank sends trade confirmation to International Broker.
5. Foreign Institutional Investor receives trade confirmation.

Settlement Date/T+1

6. Foreign Institutional Investor instructs Global Custodian on securities settlement details and funding details.
7. Global Custodian instructs Domestic Custodian on securities settlement details.
8. Domestic Custodian and Counterparty pre-match settlement details, via phone.
9. Domestic Custodian provides result of pre-matching to Global Custodian.
10. Domestic Custodian transmits settlement details to MEPS + SGS.
11. Domestic Custodian monitors settlement status updates (online).
12. Domestic Custodian funds MAS account via MEPS + RTGS.
13. Upon transfer of cash, debit/credit confirmation from MEPS + RTGS.
14. Upon transfer of securities, settlement confirmation from MAS, via MEPS + SGS.
15. Domestic Custodian sends settlement confirmation to Global Custodian.
16. Global Custodian funds SGD account with Domestic Custodian, or FCY nostro (before end of day).
17. Global Custodian sends settlement confirmation to Foreign Institutional Investor.
18. Domestic Custodian sends securities statement to Global Custodian.
19. Domestic Custodian sends debit/credit confirmations as cash statement to Global Custodian.
20. Global Custodian sends cash statement to Foreign Institutional Investor.

Source: ABMF SF2.

Thailand (THA)

Bond Market Infrastructures and Bond Transaction Flow

Figure 1. THA Bond Market Infrastructure Diagram

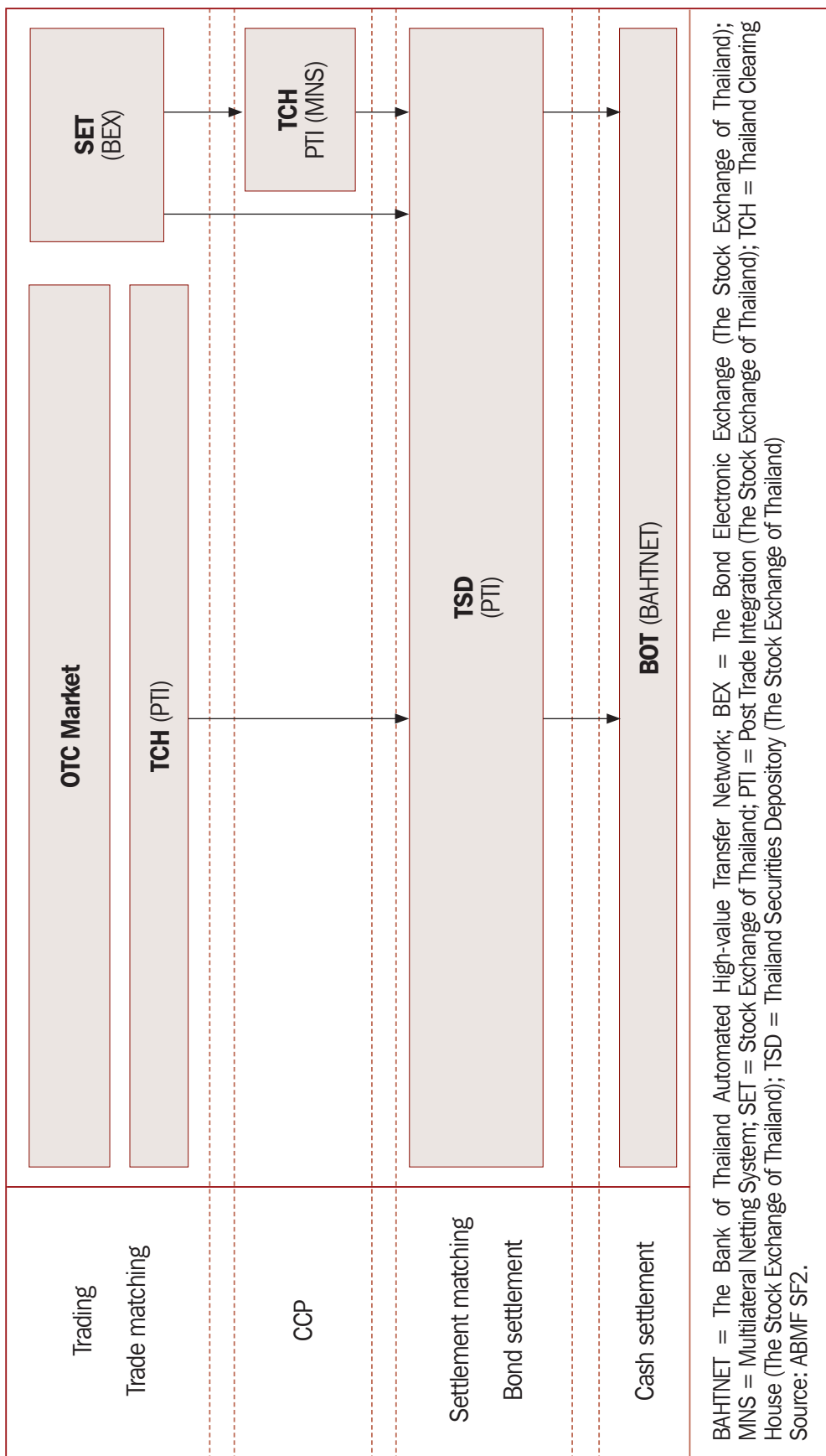
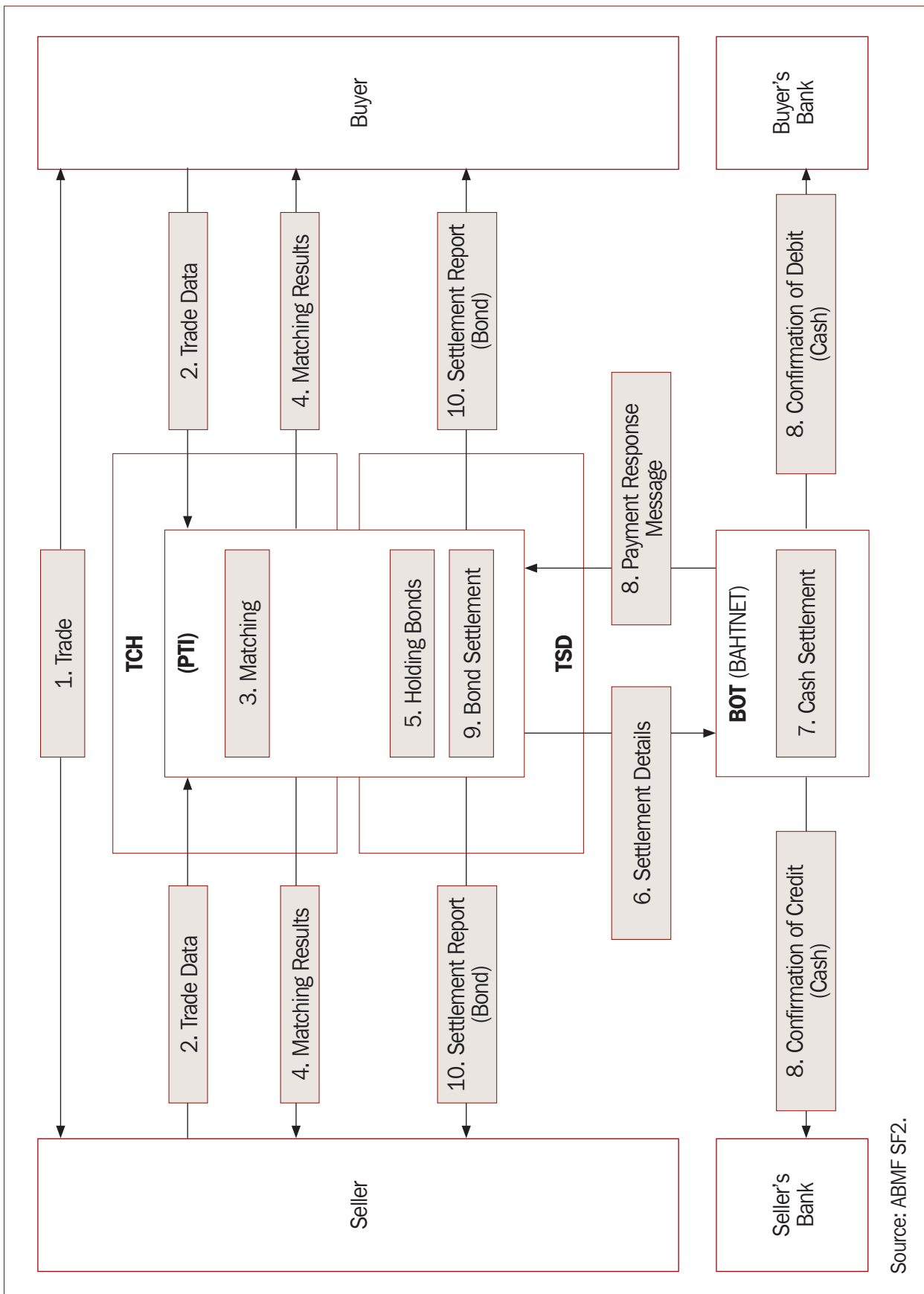

Figure 2. THA Bond Transaction Flow for Domestic Trades OTC Market/DVP



Note: Description of THA Bond Transaction Flow for Domestic Trades OTC Market/DVP**OTC Market**

1. Seller and buyer trade via OTC market.
2. Seller and buyer send the transaction details to TCH via PTI System.
3. TCH matches trade data from seller and buyer.
4. TCH sends matching results to seller and buyer via PTI System.
5. TCH sends settlement details to TSD. Then, TSD checks availability and blocks securities in member account.
6. TSD sends cash settlement details to BOT.
7. BOT executes cash settlement.
8. BOT sends cash settlement confirmation to seller, buyer and TSD.
9. TSD releases blocked and executes securities delivery.
10. TSD sends settlement reports to seller, buyer and TCH via PTI System.

Source: ABMF SF2.

Figure 3. THA Bond Transaction Flow for Foreign Investors OTC Market/DVP

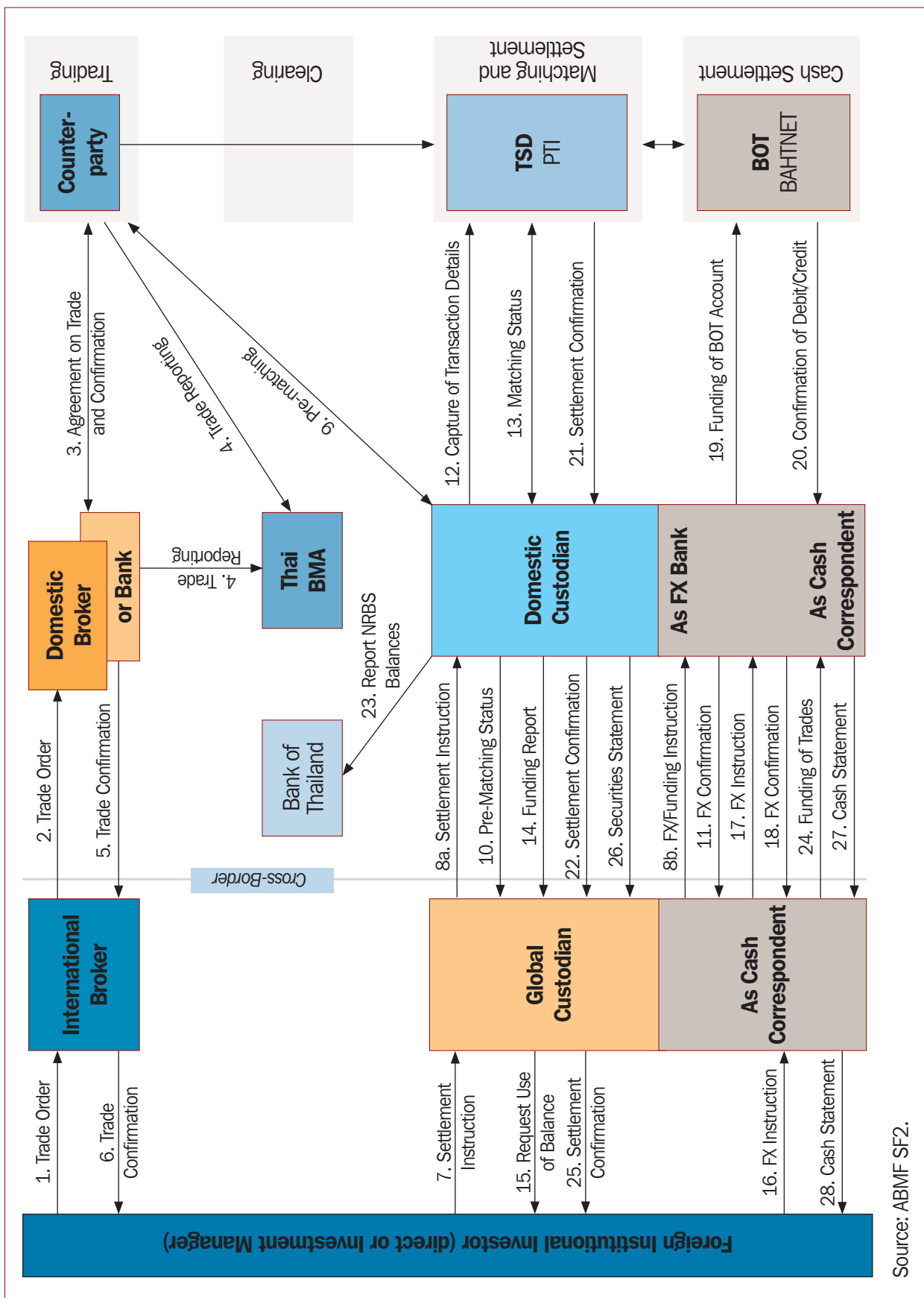

Note: Description of THA Bond Transaction Flow for Foreign Investors OTC Market/DVP

Trade Date

1. Foreign Institutional Investor places order with International Broker.
2. International Broker places order with Domestic Broker/Bank.
3. Domestic Broker/Bank trades OTC with Counterparty (via phone or Bloomberg).
4. Domestic Broker/Bank and Counterparty report trade to Thai BMA within 30 minutes of trade (web input or, e.g., via Bloomberg).
5. Domestic Broker/Bank sends trade confirmation to International Broker.
6. Foreign Institutional Investor receives trade confirmation.

T+1

7. Foreign Institutional Investor instructs Global Custodian on securities settlement and cash/funding details.
8. Global Custodian instructs Domestic Custodian on (a) securities settlement details, (b) FX request or funding details.
9. Domestic Custodian pre-matches with Counterparty, typically via phone.
10. Domestic Custodian sends pre-matching results to Global Custodian.
11. Domestic Custodian sends FX confirmation to Global Custodian.

Settlement Date

12. Domestic Custodian captures settlement details in PTI.
13. Domestic Custodian retrieves matching results, via TSD terminal.
14. Domestic Custodian sends funding report to Global Custodian.
15. Global Custodian sends, if so required, request to use THB balance to Foreign Institutional Investor.
16. Foreign Institutional Investor sends, if so required, FX instruction (or additional securities purchase trade) to Global Custodian.
17. Global Custodian, if so required, sends FX instruction to Domestic Custodian, as FX bank.
18. Domestic Custodian, as FX bank, confirms FX deal.
19. Domestic Custodian funds clearing account at Bank of Thailand.
20. Upon cash settlement/transfer, BAHTNET sends credit/debit confirmation to Domestic Custodian (as BAHTNET participant).
21. Upon cash settlement confirmation, TCH/TSD transfers securities and sends settlement confirmation to Domestic Custodian.
22. Domestic Custodian sends settlement confirmation to Global Custodian.
23. Domestic Custodian reports clients' NRBS account balances to Bank of Thailand (prior to end of day).
24. Global Custodian funds account with Domestic Custodian directly, or into FCY nostro account (by end of day).
25. Global Custodian sends settlement confirmation to Foreign Institutional Investor.
26. Domestic Custodian sends statement of securities to Global Custodian (end of day).
27. Domestic Custodian sends cash credit/debit information in cash statement to Global Custodian (end of day).
28. Global Custodian sends cash credit/debit information to FI in cash statement (end of day).

Source: ABMF SF2.

Viet Nam (VIE)

Bond Market Infrastructures and Bond Transaction Flow

Figure 1. VIE Bond Settlement Infrastructure Diagram

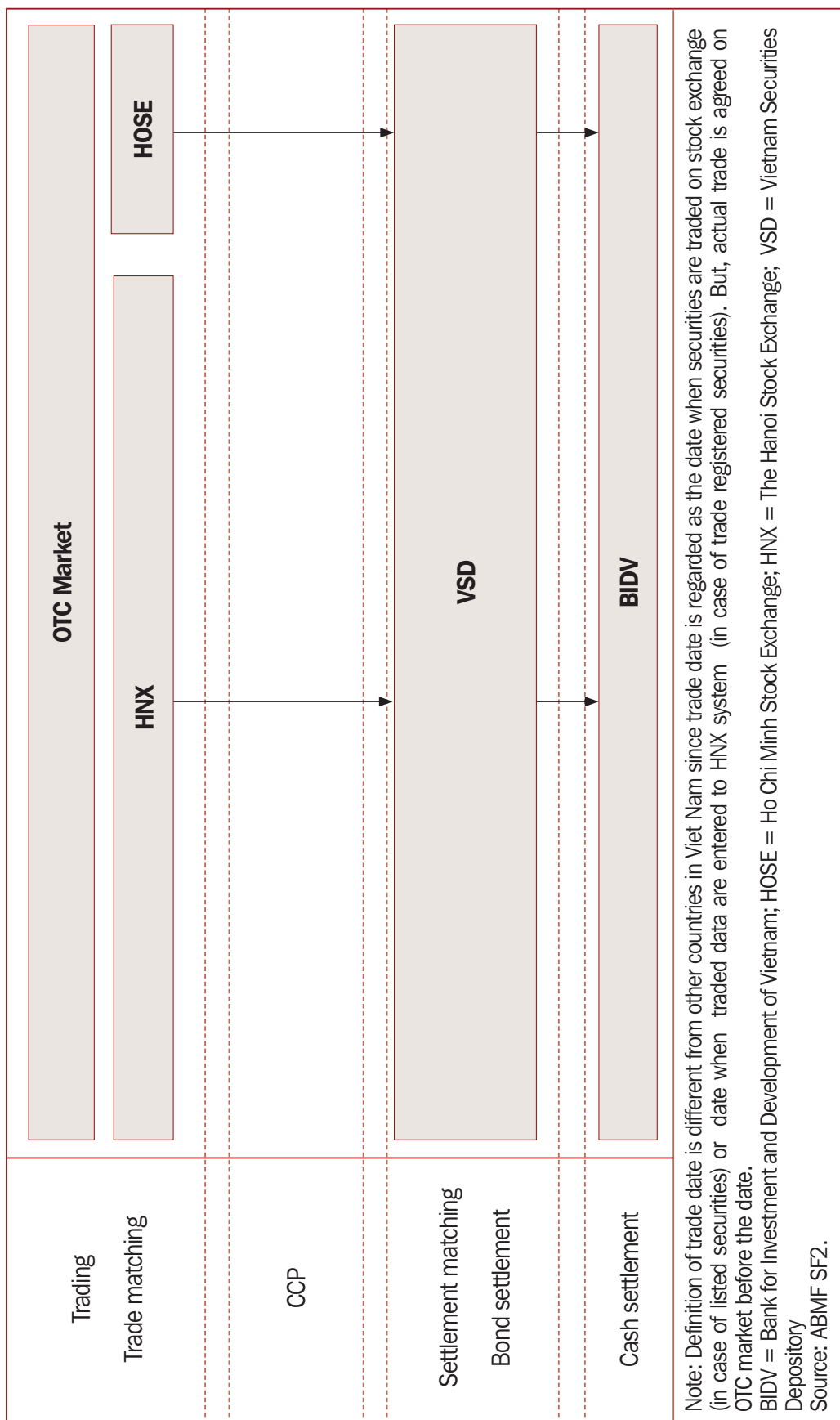
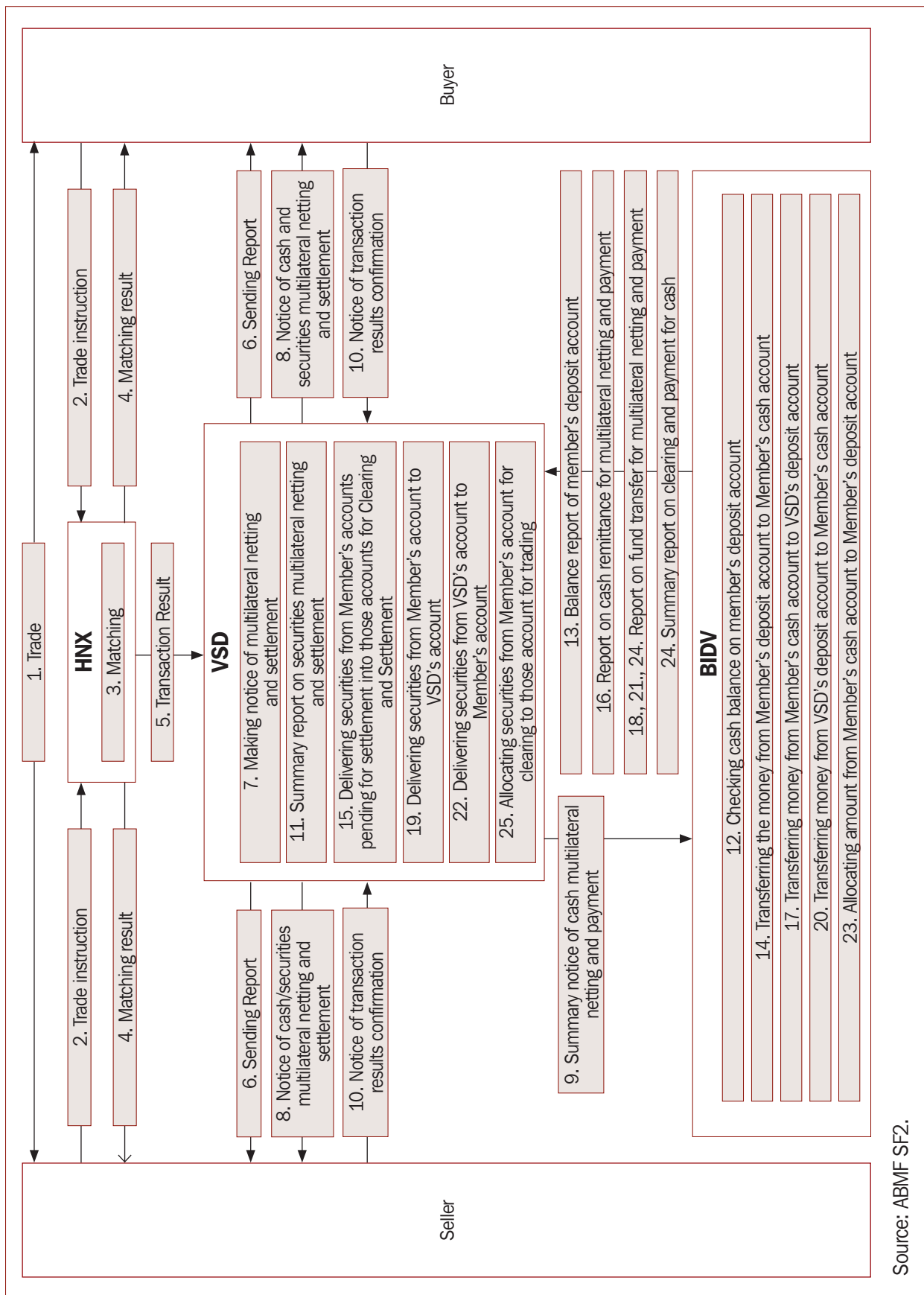

Figure 2. VIE Business Process Flow Government Bond Market/DVP



Source: ABMIF SF2.

Note: Description of VIE Business Process Flow Government Bond Market/DVP (1/2)

OTC Market

1. The seller and buyer execute bond trades via direct negotiation methods. Trade is executed before trading day, because trading day is the day when the seller and buyer input the instruction into the system.
2. Both the seller and buyer input trade instruction into the exchange system of HNX.
3. After inputting, the exchange system automatically matches the trade instructions.
4. Trading result is confirmed to the seller and buyer.
5. Each exchange market sends transaction result to VSD. VSD checks bond holding information of depository member's clients.
6. VSD makes and sends reports to members including: Summary notice of transaction results; Notice of accounts lacking securities for settlement; and Notice of updating investor's information. After receiving the report, members check their transactions.
7. From 14:30 to 15:30, VSD makes notice of multilateral netting and settlement.
8. From 15:30 to 16:00, VSD sends to each member "Notice of cash multilateral netting and payment" and "Notice of securities multilateral netting and settlement".
9. From 15:30 to 16:00, VSD sends to the settlement bank: "Summary notice of cash multilateral netting and payment" From 16:00 to 16:30, VSD sends to the settlement bank in the form of files via a line between VSD and the settlement bank. After successfully sending exported file, VSD informs the result to the settlement bank.
10. By 8:30 of the settlement day (T+1), members send "Notice of transaction result confirmation" and error correction proposal (if any) to VSD. If VSD fails to receive "Notice of transaction result confirmation" from members, all transactions shall be deemed exact and confirmed.
11. VSD makes and files "summary report on securities multilateral netting and settlement."
12. From 11:00 to 11:30, BIDV checks cash balance on member's deposit account for clearing and settlement (to ensure settlement for securities transactions in line with VSD's notice).
13. BIDV sends the balance report of member's deposit account for clearing and settlement to VSD.
14. From 13:00 to 14:00, based on the payment documents, BIDV automatically transfers the payable amount from member's deposit account for clearing and settlement (brokerage account and/or proprietary account) to their cash account for clearing and settlement.
15. Based on the payment documents, VSD automatically delivers securities from member's securities accounts pending for settlement (brokerage account and/or proprietary account) into member's securities accounts for clearing and settlement opened at VSD.
16. BIDV sends files and documents to VSD "Report on cash remittance for multilateral netting and payment" from member's deposit account for clearing and settlement to member's cash account for clearing and settlement.
17. From 14:00 to 14:30, based on the payment document, BIDV transfers money (net account payable) from member's cash account for clearing and settlement to VSD's cash account for clearing and settlement.
18. BIDV sends files and documents to VSD "Report on fund transfer for multilateral netting and payment" – from member's cash account for clearing and settlement to VSD's deposit accounts for clearing and settlement.
19. Based on the fund transfer report by BIDV, VSD delivers securities (total net volume receivable) from selling member's securities account for clearing and settlement to VSD's securities accounts for clearing and settlement. VSD and BIDV check and compare the balance in VSD's securities account for clearing and settlement and VSD's deposit account for clearing and settlement with the payment documents.

Note: Description of VIE Business Process Flow Government Bond Market/DVP (2/2)

20. From 14:30 to 14:45, based on the payment documents, BIDV automatically transfers money (total net value receivable) from VSD's deposit account for clearing and settlement to selling member's cash accounts for clearing and settlement.
21. BIDV sends files and documents to VSD's "Report on fund transfer for multilateral netting and payment" – from VSD's deposit account for clearing and settlement to member's cash accounts for clearing and settlement.
22. Based on the fund transfer report by BIDV, VSD delivers securities (total net volume receivable) from VSD's securities account for clearing and settlement to buying member's securities accounts for clearing and settlement.
23. From 14:45 to 15:00, based on the payment documents, the BIDV automatically allocates respective amount from member's cash accounts for clearing and settlement to member's deposit account for clearing and settlement (brokerage account or/and proprietary account) at the BIDV.
24. BIDV sends files and documents to VSD "Report on fund transfer for multilateral netting and payment" from member's cash accounts for clearing and settlement to member's deposit account for clearing and settlement and "Summary report on clearing and payment for cash".
25. Pursuant to the fund transfer report by the BIDV, VSD allocates the respective securities from member's securities accounts for clearing and settlement to member's securities accounts for trading (brokerage accounts and/or proprietary accounts).

Source: ABMF SF2.

Figure 3. VIE Business Process Flow: Revised Bond Market/DVP

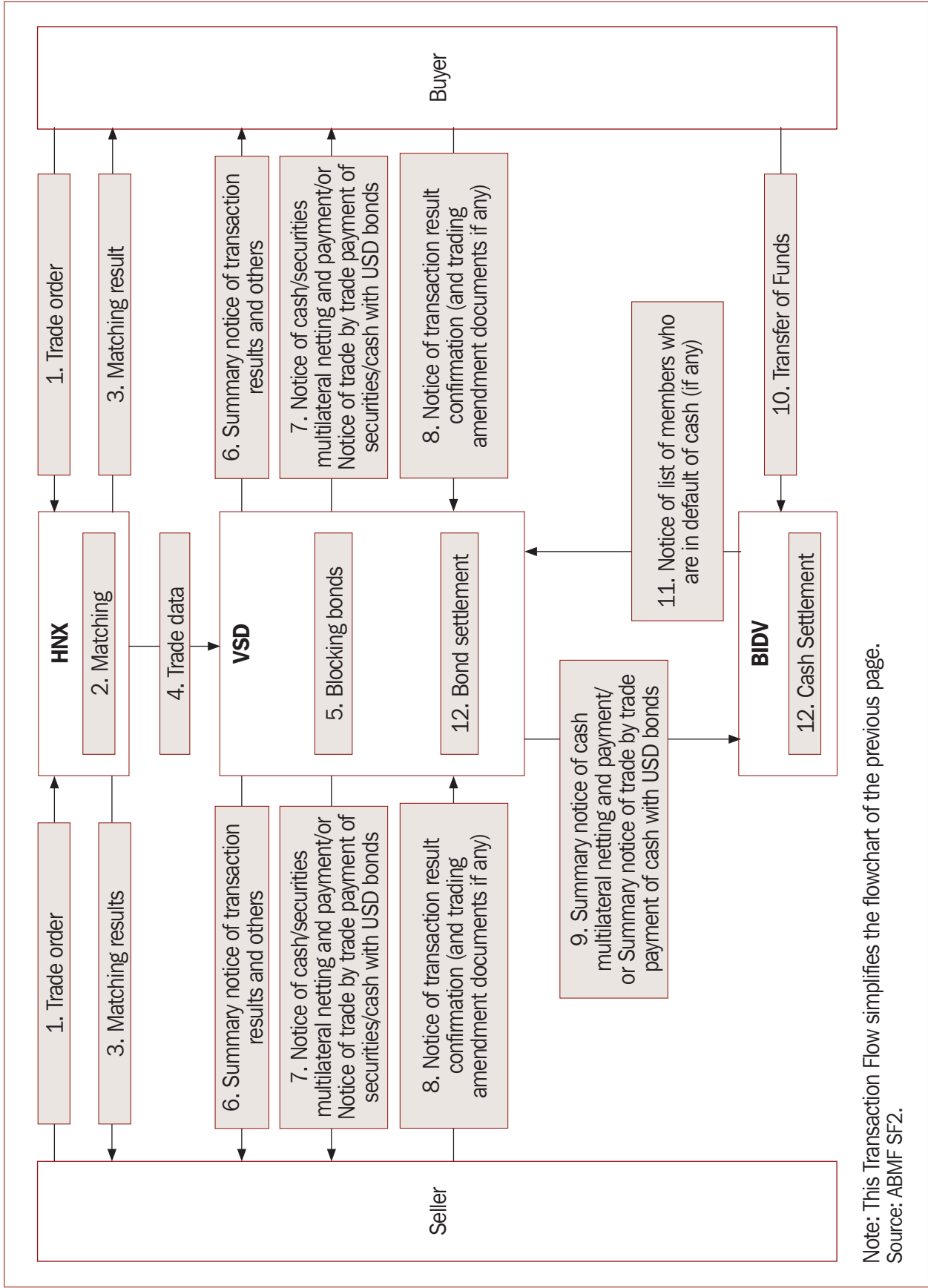

Note: This Transaction Flow simplifies the flowchart of the previous page.
Source: ABMF SF2.

Note: Description of VIE OTC Bond Transaction Flow for Foreign Investors

T-1

1. Foreign Institutional Investor sends FX/funding instruction to Global Custodian (for planned bond trades).
2. Global Custodian sends FX/funding instruction to Domestic Custodian (to ensure timely availability of VND).
3. Foreign Institutional Investor places order with International Broker.
4. International Broker places order, typically with Domestic Bank.
5. Domestic Broker/Bank trades OTC with Counterparty (via phone), both parties signs trade agreement (contract).
6. Domestic Broker/Bank sends trade confirmation to International Broker.
7. International Broker sends trade confirmation to Foreign Institutional Investor.
8. Domestic Bank sends trade confirmation to Domestic Custodian.
9. Foreign Institutional Investor sends securities settlement instruction to Global Custodian.
10. Global Custodian instructs Domestic Custodian on securities settlement details.
11. Domestic Bank relays trade details to Domestic Broker (as HNX member) for trade capture.

Trade Date

12. Domestic Broker checks available funds/bonds with Domestic Custodian.
13. Domestic Broker captures trade details on HNX, typically via eBond front-end system.
14. VSD provides Settlement Report to Domestic Custodian (at end of "Trade Date").
15. Only in the event of a discrepancy, does Domestic Custodian need to contact VSD (hence dashed arrow).
16. Domestic Custodian provides settlement/matching status to Global Custodian.
17. Domestic Custodian sends FX confirmation to Global Custodian.
18. Global Custodian sends FX confirmation to Investor.
19. Domestic Custodian effects funding of BIDV account.
20. After settlement deadline, Domestic Custodian retrieves settlement confirmation from VSD (hardcopy, or online).

Settlement Date/T+1

21. After settlement deadline, Domestic Custodian retrieves cash debit/credit confirmations from BIDV (hardcopy).
22. Domestic Custodian sends settlement confirmation to Global Custodian.
23. Global Custodian effects funding of account with Domestic Custodian, or into FCY nostro account (before end of day).
24. Global Custodian sends settlement confirmation to Foreign Institutional Investor.
25. Domestic Custodian sends securities statement to Global Custodian.
26. Domestic Custodian sends debit/credit information in cash statement to Global Custodian.
27. Global Custodian sends cash statement to Foreign Institutional Investor.

Source: ABMF SF2.

Bond Market Infrastructure Diagram

Figure 1. ASEAN +3 Government Bond Market Infrastructure Diagram

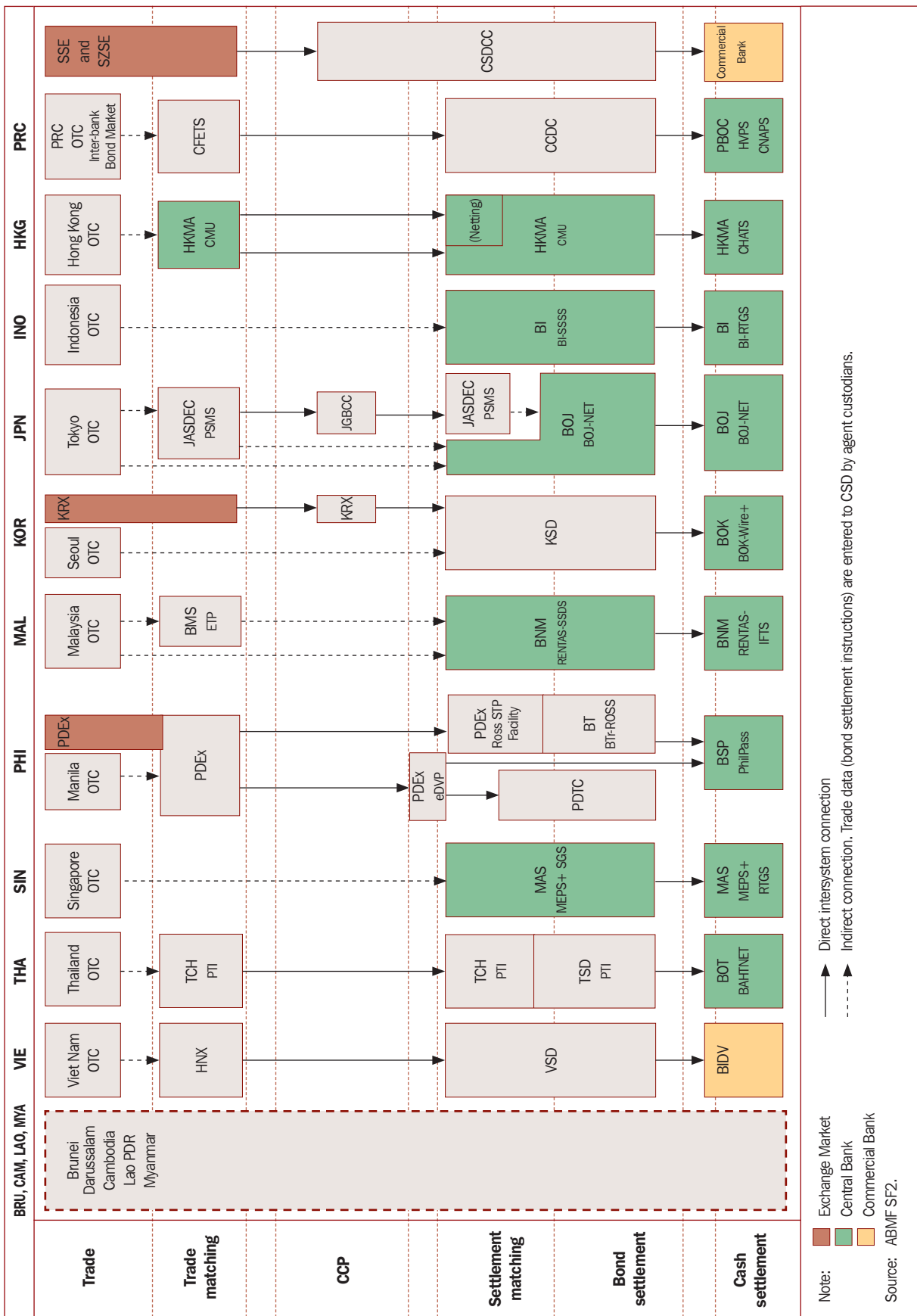

ASEAN+3 Bond Market Guide

The *ASEAN+3 Bond Market Guide* contains the comprehensive reports of the ASEAN+3 Bond Market Forum Sub-Forum 1 (SF1) and Sub-Forum 2 (SF2). The SF1 report (Volume 1) analyzes the harmonization and standardization of the existing bond markets in the ASEAN+3. It also contains the individual market guides of 11 economies under the ASEAN+3 Bond Market Forum (ABMF). The SF2 report (Volume 2) provides an overview of the ASEAN+3 bond markets and their infrastructures, as well as issues confronted by each bond market in the region. It also presents bond-market infrastructure diagrams, domestic bond transaction flows, and cross-border bond transaction flows, which can help the reader to visually navigate the existing bond market infrastructures in the region.

The report is the product of the collaborative efforts of the National Members and Experts and International Experts of the ABMF in cooperation with the Asian Development Bank's Office of Regional Economic Integration.

About the Asian Development Bank

ADB's vision is an Asia and Pacific region free of poverty. Its mission is to help its developing member countries reduce poverty and improve the quality of life of their people. Despite the region's many successes, it remains home to two-thirds of the world's poor: 1.8 billion people who live on less than \$2 a day, with 903 million struggling on less than \$1.25 a day. ADB is committed to reducing poverty through inclusive economic growth, environmentally sustainable growth, and regional integration.

Based in Manila, ADB is owned by 67 members, including 48 from the region. Its main instruments for helping its developing member countries are policy dialogue, loans, equity investments, guarantees, grants, and technical assistance.

Asian Development Bank
6 ADB Avenue, Mandaluyong City
1550 Metro Manila, Philippines
www.adb.org